

The design of a structure to accommodate a KwaZulu-
Natal Institute for the Built Environment in Durban

Marc John Oswell

A DISSERTATION SUBMITTED TO THE SCHOOL OF ARCHITECTURE, PLANNING AND
HOUSING, UNIVERSITY OF KWAZULU-NATAL DURBAN, IN PARTIAL FULFILMENT OF A
MASTERS IN ARCHITECTURE DEGREE

2008

DECLARATION

Submitted in partial fulfilment of the requirements for the degree of Master of Architecture, in the Graduate Programme in the School of Architecture, Planning and Housing, University of KwaZulu-Natal, Durban South Africa.

I declare that this dissertation is my own unaided work. All citations, references and borrowed ideas have been duly acknowledged. It is being submitted for the degree of Master of Architecture in the Faculty of Humanities, Development and Social Science, University of KwaZulu-Natal, Durban South Africa. None of the present work has been submitted previously for any degree or examination in any other University.

MARC JOHN OSWELL

Student name



Signature

04 . 03 . 2009

Date

CONTENTS

•	Abstract	
•	Acknowledgments	
•	Introduction	
•	Chapter 1	Research Background 1
	•	1.1. Research background 1
	•	1.2. Research problem 2
	•	1.3. Key questions 4
	•	1.4. Working hypotheses 5
	•	1.5. Aims and objectives of the study 5
•	Chapter 2	Research Methods 6
	•	2.1. Secondary data 6
	•	2.2. Primary data 7
•	Chapter 3	Literature Review and theoretical Framework 8
	•	3.1. Literature Review 8
	•	3.2. Theoretical Framework 11
•	Chapter 4	Precedent Studies 16
	•	4.1. Yale School of Art and Architecture 16
		4.1.1. An introduction to the project 16
		4.1.2. The brief 16
		4.1.3. Design concepts 17
		4.1.4. Site characteristics 18

4.1.5. <i>Spatial arrangement of the accommodation</i>	18
4.1.6. <i>Positive aspects of the design</i>	19
4.1.7. <i>Negative aspects of the design</i>	20
4.1.8. <i>Conclusions towards the design of a KZN Institute for the Built Environment</i>	22
• 4.2. <i>Oporto School of Architecture</i>	29
4.2.1. <i>An introduction to the project</i>	29
4.2.2. <i>The brief</i>	29
4.2.3. <i>Design concepts</i>	29
4.2.4. <i>Site characteristics</i>	32
4.2.5. <i>Spatial arrangement of the accommodation</i>	32
4.2.6. <i>Positive aspects of the design</i>	33
4.2.7. <i>Negative aspects of the design</i>	34
4.2.8. <i>Conclusions towards the design of a KZN Institute for the Built Environment</i>	34
• 4.3. <i>London Centre for Architecture</i>	41
4.3.1. <i>An introduction to the project</i>	41
4.3.2. <i>The brief</i>	42
4.3.3. <i>Design concepts</i>	42
4.3.4. <i>Site characteristics</i>	43
4.3.5. <i>Spatial arrangement of the accommodation</i>	44
4.3.6. <i>Positive aspects of the design</i>	45
4.3.7. <i>Negative aspects of the design</i>	46
4.3.8. <i>Conclusions towards the design of a KZN Institute for the Built Environment</i>	47

• Chapter 5	Case Studies	50
	• 5.1. <i>'Boukunde', the Pretoria School for the built Environment</i>	50
	5.1.1. <i>Reasons for choosing the case study</i>	50
	5.1.2. <i>Introduction</i>	51
	5.1.3. <i>The history of the 'Boukunde' Building</i>	51
	5.1.4. <i>An Evaluation of the Building Today</i>	54
	5.1.5. <i>Conclusions from a discussion with Prof. R. Fisher</i>	58
	• 5.2. <i>The Kwa-Zulu Natal Institute for Architecture</i>	64
	5.2.1. <i>Reasons for choosing the case study</i>	64
	5.2.2. <i>Introduction</i>	64
	5.2.3. <i>A brief history of the KZNIA</i>	65
	5.2.4. <i>The functions of the Institute</i>	65
	5.2.5. <i>An evaluation of site and building</i>	66
	5.2.3. <i>Conclusions</i>	67
• Chapter 6	Design Requirements and Brief	69
	• 6.1. <i>Design Requirements</i>	69
	6.1.1. <i>Exhibition Space</i>	69
	6.1.2. <i>Auditorium</i>	72
	6.1.3. <i>Catering Facility</i>	74
	6.1.4. <i>Library</i>	75
	6.1.5. <i>Administration</i>	78
	6.1.6. <i>Studios</i>	79
	6.1.7. <i>Lecture, seminar and CAD teaching rooms</i>	80
	• 6.2. <i>Accommodation Schedule</i>	82

• Chapter 7	Site Criteria and Selection	84
	• 7.1. Site Criteria	84
	7.1.1. Urban Characteristics	84
	7.1.2. Social Considerations	85
	7.1.3. Environmental Considerations	85
	• 7.2. Site Options	86
	7.2.1. Introduction	86
	7.1.2. Locations	86
	• 7.3. Site Option 1 – Sutton Park	87
	7.3.1. Introduction	87
	7.3.2. Urban Characteristics	87
	7.3.3. Social Considerations	88
	7.3.4. Environmental Considerations	89
	7.3.5. Conclusions	89
	• 7.4. Site Option 2 – Warf Site	90
	7.4.1. Introduction	90
	7.4.2. Urban Characteristics	90
	7.4.3. Social Considerations	91
	7.4.4. Environmental Considerations	92
	7.4.5. Conclusions	92

•	7.5. Site Option 3 – Bulwer Park	93
	7.5.1. Introduction	93
	7.5.2. Urban Characteristics	93
	7.5.3. Social Considerations	95
	7.5.4. Environmental Considerations	95
	7.5.5. Conclusions	96
•	7.6. Site Choice - Conclusions	97
•	Chapter 8 Site Analysis – Bulwer Park	98
	8.1. Location	98
	8.2. Routes through the site	99
	8.3. Surrounding building use	100
	8.4. Existing buildings on the site	102
	8.5. Solar orientation and wind directions	103
•	References	106
•	Appendix A: Design Report	
•	Appendix B: Design Presentation	

ABSTRACT

South Africa is a developing country at the dawn of its democracy, confronting the challenge of providing suitable lives for its people, whilst still trying to compete in a new global village and face other challenges of the 21st century.

In this milieu of pressing problems, constraints of time and budget, the solution is almost always a compromise. Short-sighted quick solutions are the order of the day. A lack of good strategic planning leads to isolated and disconnected developments... each construction conceived in a vacuum.

But the built environment is too permanent for short-sighted solutions. The significance of design in this sphere reaches far beyond the superficiality of trend and fashion. It is the structure within which we live our lives, and the quality of our existence depends on it. Furthermore, future generations will deal with the consequences of our ill-considered blunders for hundreds of years to come.

South Africa especially, cannot afford to waste limited resources on building inefficient systems. Although each isolated intervention may meet its short term goal, the ripple effect of these inefficiencies on a macro scale is unacceptable. Besides being counter-productive and hindering the country's long term development goals, the inefficient use of energy and other limited natural resources has a vastly damaging effect on our precious natural environment.

An understanding and respect for the quality of our built environment needs to be installed in our collective consciousness. Only once the gravity of each seemingly inconsequential development is fully appreciated, will we be able to construct a cohesive built environment, providing the best opportunities for future success.

This research seeks to establish the design criteria for a Kwa-Zulu Natal Institute for the Built Environment. This would be a centre for facilitating positive interactions between individuals from various backgrounds involved and interested in improving the quality of our built environment and promoting interest to the public.

ACKNOWLEDGEMENTS

I would like to thank the following people for their assistance in compiling this document:

- My supervisors, Alethea Duncan-Brown, Deon Brius, Githithu Mahinda, and the rest of the staff at the School of Architecture at UKZN who have guided me over the years.
- Tony Wilson, for acknowledging my potential, even when my own effort was lacking.
- Derek Wang, for always offering a wise perspective.
- Professor Roger Fisher (School for the Built Environment, University of Pretoria) for some very valuable direction at the start of this project.
- My fellow students and close friends, who shared with me so many 'all-nighters' in the studios.
- My family for their support, encouragement and patience.
- Angela, for your valued opinion and the encouragement which gave me the confidence to design, as well as for working so tirelessly with me in the final hours. I wouldn't have done it without you.

INTRODUCTION

This research will explore the best possible building solution to house a new centre for the education, information and awareness of the built environment disciplines in KwaZulu-Natal. Various factors will be investigated in order to make the most informed conclusions. This will include an assessment of the most sensible location in Durban, accessing the optimal learning environments for students engaged in the design of the built environment, as well as how to best facilitate a mutually beneficial integration of students, practicing professionals and interested members of the public. Exploring which passive building ventilation and cooling methods could be employed, specifically to work best in Durban, would also make up a substantial area of the research.

One of the main concepts to be explored, will be the idea to integrate both a school for built environment studies and the Kwa-Zulu Natal Institute for Architecture, into one complex. This would be done not only in order to replace the less than adequate facilities which are the institute's current home, but also to aid in bringing students and practitioners in closer contact with one another. A new shared facility would also be able to accommodate larger presentations and exhibitions, which could attract more interest from the public in both the institute and the school.

The aim therefore, is to design the best case scenario possible, and it is therefore the role of the research to inform the design of the building, so that it can achieve this goal.

The research question is therefore: *What is an appropriate structure to accommodate a KwaZulu-Natal Institute for the Built Environment in Durban?*

Chapter 1: *Research Background*

1.1. Research Background

There is a perception that design in the sphere of the built environment is somewhat superfluous, and its significance in society is largely disregarded. The magnitude of the impact that our built environments have on our lives is not justly appreciated. A. Cortell, a noted historian, once said, "Tell me the landscape you grew up in, and I will tell you about yourself." Sir Winston Churchill adds to the argument, "We shape our buildings, and they shape us." (Bartuska, 1994:p8)

Design in this sphere is far more than aesthetic whimsy. It is not the reserve of the affluent either. It is the genius of the designer that dares to break from convention who can discover an extraordinary and innovative solution to the most mundane of problems. It is therefore the poorest that are most desperate for this skill, and as a developing nation it is essential that we embrace and nurture it.

It seems however that designers of the built environment are themselves largely responsible for reinforcing these misconceptions. Their preoccupation with style and fashion leads them to neglect greater responsibilities, and only encourages their exclusion from the decision making table.

Whether conscious of it or not, our built environment is the structural fabric within which we live our lives, and its shortcomings are everyone's burden. Society needs to recognise this fact, and establish a respect for design in this sphere.

This research will set to establish the requirements for a structure to accommodate a KwaZulu-Natal Institute for the Built Environment. An Institute with the objective of correcting misconceptions, promoting public interest and essentially installing a demand for the creation and maintenance of quality built environments in the region.

1.2. Research Problem

Durban currently has no Centre for the Built Environment. Whilst the KZNSA Gallery, the Bat Centre, Red Eye Art Gallery, and others support the arts in general, there is no facility that acts as a public window specifically for architecture, landscape architecture, interior design and urban design.

One may argue that currently the KZNIA fulfils this role for the architecture discipline, however its meetings attract little or no attention from the general public, furthermore its small facility in Bulwer Road can often not cope with the number of practitioners that do attend, and there is currently no suitable provision for exhibitions. However, these meetings take place no more than once a week, and this infrequent use of the institute's presentation and catering facilities does not warrant a larger building.

There is also no facility for students to exhibit their projects, in a venue where they can be appreciated by a larger and broader audience for a reasonable period of time. Such exhibitions would also need to be accessible to the general public if

they were to be considered a serious attraction.

If however the KZNIA and a School for the Built Environment could be accommodated in one complex, then both could benefit from shared presentation, exhibition and catering facilities.

I believe a Centre for the Built Environment would play a significant role in Durban, a place where the general public, students and practitioners could meet together. A building with the ability to facilitate an interaction that inspired interest in the Built Environment, stimulated intellectual discourse, and enhanced awareness and understanding.

The primary roles of Institute for the Built Environment in KZN would therefore be to resolve (or make progress in) the following issues:

- **The disconnection between students, professionals and the public**

There is no doubt that there is a severe disconnection between designers of the built environment (including students) and the general public, in terms of an

understanding of what the various disciplines and professionals are all about. Of course this disconnection is inevitable, but this does not mean that it is not at least somewhat amendable.

One objective of the research will be to determine an appropriate building to facilitate a positive interaction between these parties. The objective is to bring about a more informed and discerning public, which would see value in good design and demand a superior standard.

- **The lack of a permanent exhibition facility for the designers of the built environment**

There is currently no public venue in KZN, reserved specifically for the exposure of current issues and activities relating to our built environment.

Exposure is critically important; not only to generate a public awareness of developments in the province, but also to fuel a greater appreciation of those involved in designing our built environment, which then in turn promotes a higher standard of design.

- **The introduction of new CBD regulations**

New laws implemented in 2007 by the South African Council for the Architectural Profession (SACAP), require all practitioners in the field of architecture to renew their registration with the council every five years. One of the requirements for renewal is that the practitioner has undertaken certain prescribed Continuing Professional Development (CBD) activities.

CBD activities consist partly of workshops presentations and formal lectures, made to practitioners by various parities, with the objective of maintaining and enhancing the knowledge and skills necessary for the correct execution of their occupation.

The KZNIA's current facilities are too confined to accommodate these functions, and the institute is now pressed to find a solution.

- **The introduction of new SBC regulations**

There are a number of initiatives that are coming to fruition, including changes at National Building Regulations level, and

amendments at local authority level, requiring new buildings to adhere to 'green standards'.

Sustainable Building and Construction (SBC) laws will make a considerable impact on the way new buildings are constructed, and therefore create new challenges for designers of the built environment.

Not only will an Institute for the Built Environment in Durban be instrumental in assisting designers meet these challenges, but the building itself will need to set a benchmark for sustainable building construction methods.

1.3. Key Questions

- What is the best site for a Centre for the Built Environment in Durban, taking into consideration the importance of public accessibility and exposure?
- What are the building's various functions, and what are their area requirements?
- What kind of curriculum will the students follow, and how will it influence the building's requirements?
- What exactly are the functions of the KZNIA, and do they need to be re-examined?
- How could a School for the Built Environment and the Institute, mutually benefit from sharing resources and accommodation?
- What methods can be adopted in the design and construction of the building that reduce energy consumption and demonstrate for students, practitioners and public alike, sustainable design in action?
- What is an appropriate architectural language for a building, which would not only be an example of outstanding contemporary South African Architecture, but should also engage the general public and be easily comprehensible?

1.4. Working Hypothesis

An Institute for the Built Environment in Durban could facilitate an interaction between the general public, students and professionals, promoting interest, stimulating intellectual discourse, and enhancing awareness and understanding of the Built Environment disciplines.

Professionals and students would benefit from sharing ideas and being exposed to cutting-edge topics, technological innovations and other issues concerning the built environment.

The institute would also offer a permanent platform for professionals and students to exhibit their work to be viewed and appreciated by a large audience.

Not only would these interactions improve and advance the standard of design, they would lead to more informed (less indifferent) public, which would in turn demand a higher standard from designers.

1.5. Aims and Objectives of the Study

- To determine the brief. The study will conclude which functions that should be incorporated into the KZNIBE, and their respective sizes.
- To discover the most appropriate relationships between the various public, student and administrative areas in the building.
- To assemble the technical information required to design the various components of the KZNIBE.
- To establish the most favourable site requirements for an Institute for the Built Environment, and then decide on the optimum site in Durban.

Chapter 2: *Research Methods*

Both primary and secondary data was used to gather the information required to assemble this document, which ultimately informed the design process.

The methods of obtaining this data are as follows:

2.1 Secondary Data

- **Literature Review**

A literature review of existing publications which focussed on issues and concepts dealing with the built environment was carried out, and is discussed in Chapter 3. This exercise was vitally important in informing the direction of, and motivation behind, the development of a KwaZulu Natal Institute for the Built Environment.

- **Precedent Studies**

Precedent buildings were also fundamentally important in directing the concept of the KZNIBE and establishing the brief: The following precedents are examined in Chapter 4:

1. The Art and Architecture Building, Yale University, 1964, Paul Rudolph.
2. The Oporto School of Architecture, 1995, Alvaro Siza Vieira.
3. The Architecture Foundation's Centre for Architecture, London, 2008, Zaha Hadid.

Each precedent was assessed under the following headings:

- *A project overview*
- *The brief*
- *Design concepts*
- *Site characteristics*
- *The spatial arrangement of the accommodation*
- *Positive aspects of the design*
- *Negative aspects of the design*
- *A summary of lessons learnt, towards the design of a
KZN Institute for the Built Environment*

2.2. Primary Data

Primary data was collected from two case studies. The reasons for choosing these particular case studies are described in Chapter 5.

The various means of obtaining the information required to perform each case study are as follows:

- **Case Study 1: The School for the Built Environment, University of Pretoria**
 - *Interview with Prof. R. Fisher*
 - *Discussions with students in various years*
 - *A critical analysis of the accommodation using plans and sections*
 - *Own photos*
 - *Published Articles*

- **Case Study 2: KwaZulu-Natal Institute for Architecture, Glenwood, Durban**
 - *A critical analysis of the accommodation using plans and sections*
 - *An assessment of the institutes functions and requirements*
 - *Own photos*
 - *Published Articles*

Chapter 3: Literature Review and Theoretical Framework

This chapter will explore the meaning of the term 'Built Environment' in order to gain an understanding of what design in the realm of the built environment involves, and to determine the value of its role in society. This will be done through a review of various publications on the topic.

The theoretical framework, or the design philosophy of the KZNIBE, will be established and expressed. This will be done using existing theories and identifying relevant concepts in built examples.

3.1. Literature Review

A Definition of the Built Environment

The term 'Built Environment' is relatively new, but has become increasingly used and accepted in contemporary society. The term is in fact very simple, and is especially easy to grasp if one considers its antonym term: the 'Natural Environment'. Thus the 'Built Environment' is everything that is not the 'Natural Environment'.

However, this simple understanding leaves one to consider the value of a term that defines almost everything with the exception of the oceans and mountains, deserts, jungles and other vast wildernesses. Nevertheless, the value of the term 'Built Environment' is in what separates it from the 'Natural Environment': this key factor is human intervention. "The term embodies all human creation". (Bartuska, 1994)

This highlights our responsibility for the proper creation and maintenance of our built environments to best satisfy human needs, whilst still preserving the natural environments.

Bartuska defines the built environment as everything humanly made, arranged or maintained, to fulfil human purpose, to mediate the overall environment, with results that affect the environmental context.

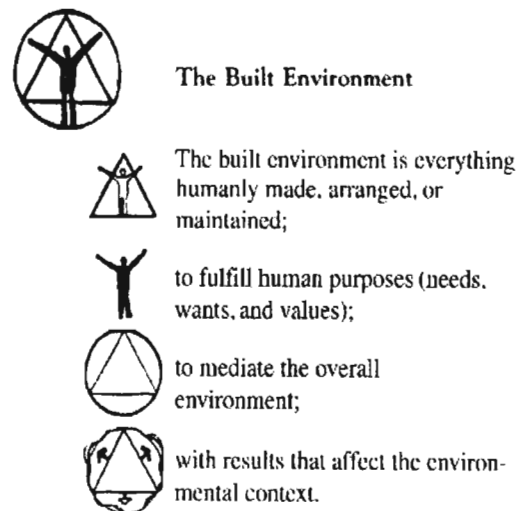

Fig 3.2.1 Illustrating the definition of the built environment. (Bartuska, 2004:5)

Design of the Built Environment

Reekie (1972) defines design (with particular reference to planning and buildings), as the conscious or intentional putting together of materials to meet certain needs. This definition includes two considerations: firstly, an establishment and clarification of the requirements or needs. And secondly, decisions as to the best means of physical realisation.

He goes on to divide the design of the built environment into three sections: planning, urban design and building design.

Planning is described as the “the general disposition of land areas for various uses, the general location of buildings and the open spaces, and provisions for services and surface communications” (Reekie 1972:4). This is the two dimensional aspect of design of the built environment.

Urban Design deals with a similar scale, however, focuses more on the specific laying out of roads, buildings and other urban elements, taking into consideration both efficiency and visual effect. It deals with building masses etc. on a three dimensional level.

The third component is Building Design. This includes the detailed design needed to construct a building or a group of buildings, including choice of materials and construction methods as well as the design of structures considered as civil engineering, all of which fall into the context of a greater planning scheme and urban design.

The Role of the Built Environment Design Disciplines in Society

A quality built environment can foster a sense of involvement and pride. However, an environment created without supportive qualities can have a very negative effect on people, causing decreasing abilities to learn and perform work. An unhealthy built environment breeds high levels of apathy, crime, vandalism and mental disease. (Bartuska: 1994)

Sometimes the substance of human action is grand, and we build quality life experiences for ourselves and others. Other times, human actions are short-sighted, creating uncomfortable situations that are less fit for healthy human activities. (Bartuska: 1994)

With regard to the destruction of our natural environment, Bartuska points out that until the industrial revolution, the built environment worldwide consisted of only small scale interventions into the natural environment which were of little or no damage to world ecology. However, since then the scale has changed dramatically... the human capability of environmental transformations has moved from little consequence to a global threat!

As designers of the built environment, we must acknowledge the far reaching consequences of our decisions at the drawing table. We should constantly be endeavouring to minimise our impact on the natural environment, for our own sake and the generations to come.

3.2. Theoretical Framework

3.2.1. An Architectural Language that Engages the Public and Communicates its Functions with a Sensible Clarity:

The design process of the KZNIBE should produce a scheme with an architectural language that clearly demonstrates best practice in contemporary South African architecture and communicates it to the broadest public audience.

The architectural language would therefore reflect of the institute's primary motivation, which is to communicate to, and enhance, the publics' understanding and awareness of the various built environment design disciplines and their significance in society.

- **Form**

The overall form, or massing, of the KZNIBE should clearly communicate its various functions. Rather than creating a building with a single unanimous form, thus compromising the spatial needs of each of the institute's unique components by restricting them to conform to the boundaries of a uniform floor plan outline and limiting spatial arrangement to vertical displacement, a more function

responsive and spatially experiential solution seems appropriate.

Each component of the KZNIBE should therefore be designed separately, thus generating its own form specific to its unique function. These various forms would then be arranged according to the requirements of the program to generate the overall form of the building. The completed massing thus maintains the legibility of each component in the institute, which facilitates orientation and an effortless understanding of how the building works.

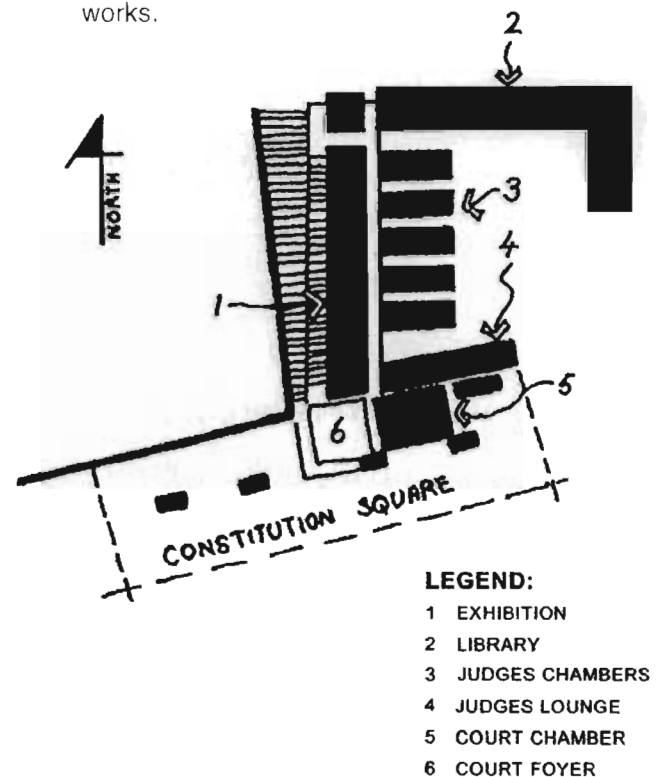

Fig 3.2.1 The fragmented layout of the Constitutional Court Building in Johannesburg. (Arch SA, July/Aug 2004, p11)

The Constitutional Court building in Johannesburg is an excellent (South African) example of architecture which demonstrates this concept. The building consists of six separate components (Fig 3.2.1), and yet each has a distinct form, derived from each components specific function. As a result one component does not compromise the formal and spatial arrangement needs of another.



Fig 3.2.2 One of the wings specifically designed for the Judges' Chambers (Arch SA, July/Aug 2004, p12)

- **Structure**

It seems appropriate that a building, whose primary function is to facilitate and develop an understanding of the Built Environment design

disciplines, is supported by structure that can be easily understood. In other words, it should be reasonably apparent how the building was put together, and what it is made of. A structure that is logical and legible, whilst still imaginative and inventive.

For example, note how the reinforced concrete frame structure of the Judges' Lounge at the Constitutional Court (Fig 3.2.3) is exposed and expressed on the façade, rather than concealed beneath a uniform plaster and paint finish.



Fig 3.2.3 The Judges' Lounge (Arch SA, July/Aug 2004, p12)

Such design decisions support an architectural design philosophy of structural integrity. The structure, the 'nuts and bolts' and 'skeleton' of the KZNIBE should therefore be exposed and expressed. Details should be bold and tactile.

The intention is not to create or conform to a style, but rather to assist an understanding of construction methods and reinforce this design ethos.

- **Materials**

The architecture should also comprise a diverse vocabulary of materials. Just as the use of each word is carefully considered by a poet to achieve the maximum effect, each material selected should be so meticulously considered. A well considered pallet of materials, that react in unique and interesting ways to the change of light for example, could make the buildings forms dance to life.

The Constitutional Court building is again an excellent South African example of architecture which exemplifies this. As Alan Lipman states, "The building's regional character rests primarily in its materials, their assembly (and) their inventive detailing." (Architecture SA, Jul/Aug 2004 p16)

Fig 3.2.4 *One of the screens that enclose the exhibition hall. (Arch SA, July/Aug 2004, p12)*



3.2.2. Creating an Experience, Rather than just a Building

A unique and exciting or inspiring experience is difficult to define. Though somewhat intangible, an exceptional experience is a vastly valuable commodity. Furthermore, it is the key ingredient which separates ordinary buildings from extraordinary architecture.

All great works of architecture, no matter how different, have this quality in common. From residences like Frank Lloyd Wright's 'Falling Water' to large city monuments like Gustoff Eiffel's Paris tower, all offer a unique and captivating experience.

3.2.3. The Architecture should generate a Powerful Symbol

"Symbol dominates space. Architecture is not enough. Because the spatial relationships are made by symbols more than by forms, architecture in this landscape (Las Vegas) becomes symbol in space rather than form in space – architecture defines very little: the big sign and little building is the rule of route 66."
(Venturi 1972:13)

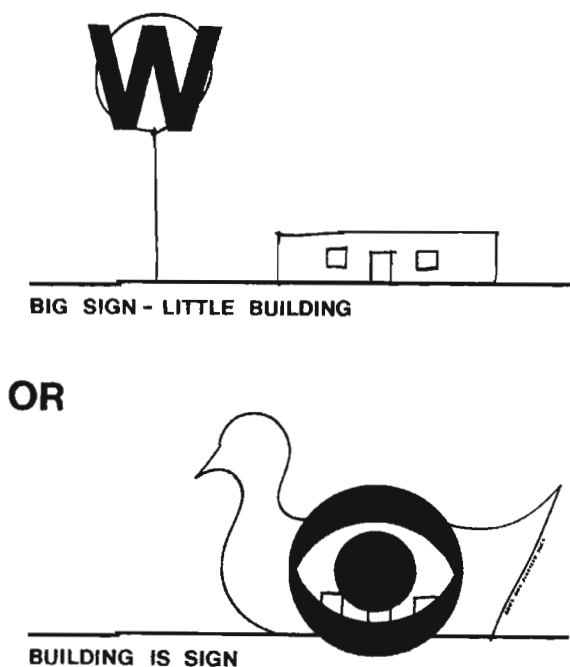

Fig 3.2.5 (Venturi, 1972:17)

In order to achieve its objectives, the KZNIBE needs to make a significant impact on its surrounding urban environment. Although great exposure is crucially important as a method of attracting public interest, the building also needs to be a symbolic reference in Durban.

As Venturi argues in 'Learning from Los Vegas', unlike many modern buildings, the architecture of a structure alone, should be able to generate a powerful symbol... thus communicating for itself, rather than resorting to other devices such as a large sign intended to catch attention and point to a symbolically ineffective building. (Fig 3.2.5 & 3.2.6)



Fig 3.2.6 (Venturi, 1972:156)

3.2.4. Complexity and Contradiction in a South African Context

Whilst still designing in a modern manner, it is important to acknowledge that the principle has evolved substantially since the dawn of modernity. Robert Venturi argues that the purist creations of early modern architects such as Mies van der Rohe and Philip Johnson lacked the essential elements of complexity and contradiction required in architecture. Debatably, most contemporary modern architecture is guilty of succumbing to the same shortcoming.

Paul Rudolph believed this occurred because modern architects deliberately chose to solve only some of the problems in the brief, and ignored the rest. "Indeed it is a characteristic of the twentieth century that architects are highly selective in determining which problems they want to solve. Mies, for instance makes wonderful buildings only because he ignores many aspects of a building. If he solved more problems, his buildings would be far less potent." (Rudolph, 1961:p51)

Conversely, when an architect does attempt to solve all the problems arising from the brief, complexity and contradiction can't be avoided. The problems facing architects in South Africa are especially apparent. Thus, when our architecture is influenced by these real

concerns, such as climate, culture, context and environmental sustainability, then it cannot avoid developing a relevant and distinctive richness.

The resultant complexity of such architecture is completely honest, and has an undisputable logic and integrity to it, because its complexities are derived from solving real problems, rather than the result of whimsy. Thus, the architecture produced returns true to the modern ideal of form following function.

3.2.5. A Building which Reflects the Unique Character of Durban

It's well accepted that Durban has its own unique character. A sub-tropical port city which brings to mind images of palm trees, art deco buildings, rolling hills and Victorian veranda houses. It is therefore conceivable that there is an architecture language which is most appropriate in this context, just as there is for Cape Town or Johannesburg.

Of course one should avoid interpreting this idea too literally. Doing so would only produce an inappropriate cliché, like a structure resembling a Zulu hut for example. Rather one may begin by addressing the climate, topography or vegetation and discover a suitable expression from there.

Chapter 4: Precedent Studies

4.1. The Art and Architecture Building, Yale University – Paul Rudolph – 1958-1964

4.1.1. An Introduction to the Project

Paul Rudolph's Art and Architecture building on the Yale Campus in New Haven USA, "is still his most notorious structure" (Monk: 1999, 39) from a long career of substantial commissions, and yet he was only forty years old at the time of its design.

It was a high-profile project for Yale University, with a site on the corner of Chapel and York Street. The site required the scheme to be particularly sensitive to its context, in order to fit into the surrounding urban environment, which included the Yale Art Gallery designed earlier by Louis Kahn.

4.1.2. The brief

The school was designed to accommodate approximately 360 students, half of them being art students and the other half architecture students.

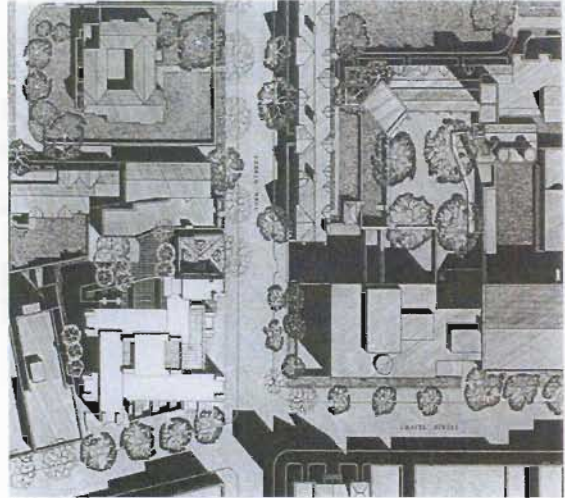

Fig 4.1.1 Site plan, Schwab: 1970, 121

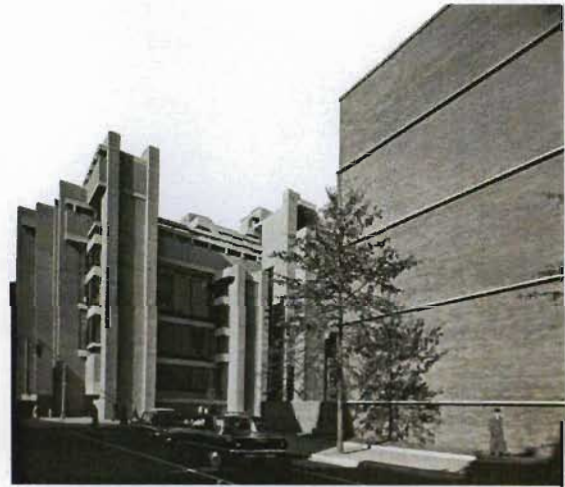

Fig 4.1.2 Rudolph's building with Kahn's gallery in foreground, Schwab: 1970, 123



Fig 4.1.3 The building's imposing presence on the street corner, Schwab: 1970, 123

A key factor which contributed to the extraordinary nature of this project was that Rudolph was in the unique position of being both architect and client, and he could therefore design the brief to suit himself.

"External forces dictated that this building turn the corner and relate to the modern building opposite as well as suggest that it belongs to Yale University. The internal forces demanded an environment suitable for ever varying activities which will be given form and coherence by the defined spaces within. As the years go by, it is hoped other interests and activities will take place within the spaces, but the space itself will remain." (Rudolph, 1970:p120)

4.1.3. Design concepts

Rudolph considered that his design fitted remarkably well into its surroundings, and went to great pains to achieve this. He accurately drew the elevation of every building in the street scene from College Green up to the Art and Architecture Building, and beyond.

This careful consideration of the surrounding architecture is evident in the final product. In response to the horizontal composition of Louis Khan's adjacent gallery, Rudolph used massive towers to create a dominant vertical composition, juxtaposing Khan's.

As part of his design process Rudolph created five different designs, each with distinguishing facades, so that he could decide on his ultimate scheme. (Fig 4.1.4 & 4.1.5)

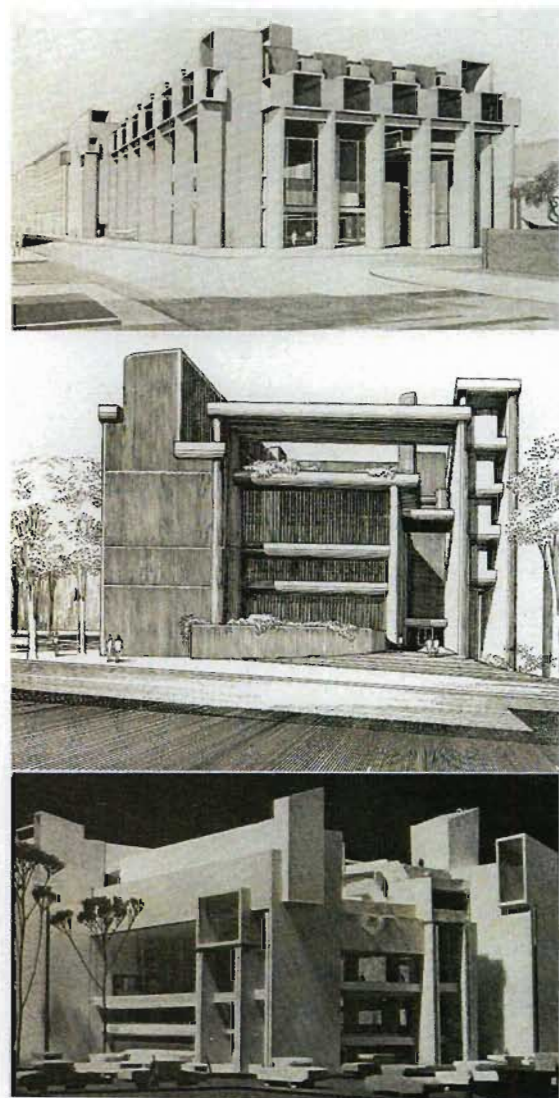

Fig. 4.1.4 Rudolph's various schemes, Schwab: 1970, 122

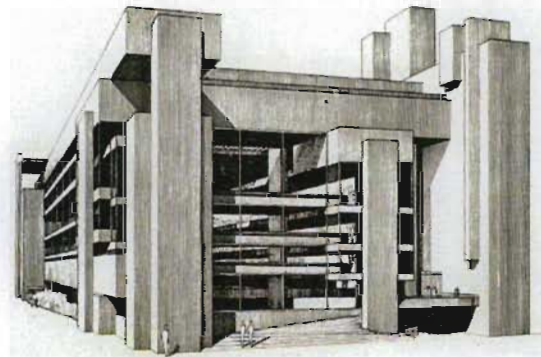
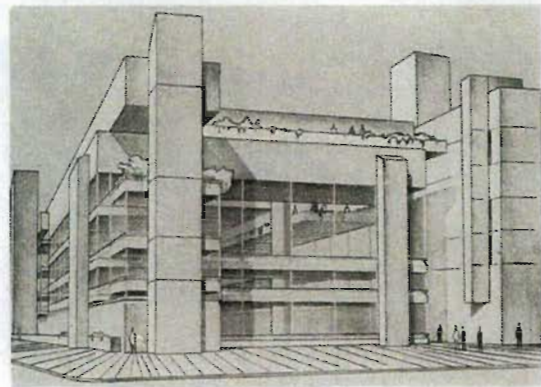
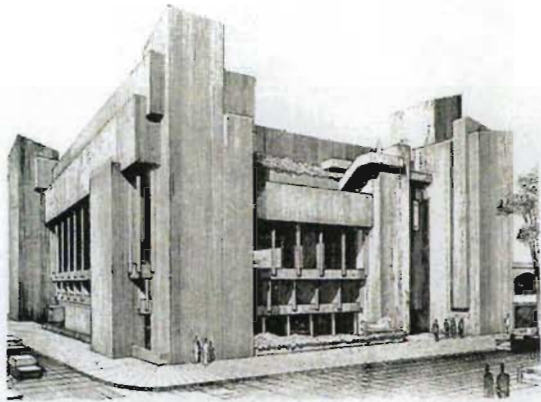

Fig. 4.1.5 Rudolph's various schemes, Schwab: 1970, 122

Rudolph believed he had demonstrated how it was possible to design exclusively in a modern manner, and yet still be sympathetic to the Neo-Gothic building nearby, by blending in terms of colour, scale, texture, disposition, dimensions, dimensions and profile.

4.1.4. Site characteristics

The school is positioned on an especially prominent corner site, surrounded by a rich urban context of some of America's most renowned buildings.

The site was challenging, although flat, it is small compared to the vast amount of accommodation the school required. Rudolph therefore had to design the building over seven floors, two of which are basements. This scale is however typical of the Yale campus, which has a relatively high density.

4.1.5. Spatial arrangement of the accommodation

"The interior is a *tour de force* of spatial design." (Monk: 1999, 40) At the heart of the nine storey structure are two double-volume spaces, one above the other. These house the large critique and lecture areas, and form the central core of the building, around which the mezzanine studios are arranged at various levels.

There are also other lecture rooms in the basement, as well as seminar and exhibition rooms on the two 'roof-garden' levels.

The building is almost entirely formed from concrete poured in-situ. Four massive columns

rise up majestically through the heart of the building. They define and support the huge steel-reinforced concrete beams which span across the central spaces, and allow interesting high-level natural light to penetrate the internal rooms.

4.1.6. Positive aspects of the design

The design was so innovative, that a contract with the builder was negotiated during the design process so that experimental construction techniques could be perfected. A completely original off-shutter concrete finish was developed by Rudolph especially for the project. Vertically ribbed shutters were used, and the protruding ribs hammered manually to reveal the stone aggregate. This texture reinforces the building's vertical composition and prevents unsightly stains from appearing on the building due to weathering. This finish was later used extensively by Rudolph and many other architects all around the world.

When the project was completed in 1964, it was highly praised by the leading architectural academia of the time. It was so significant because it demonstrated a new, more carefully considered approach to modern architecture by departing from the Miesian glass box, which had become the fashion.

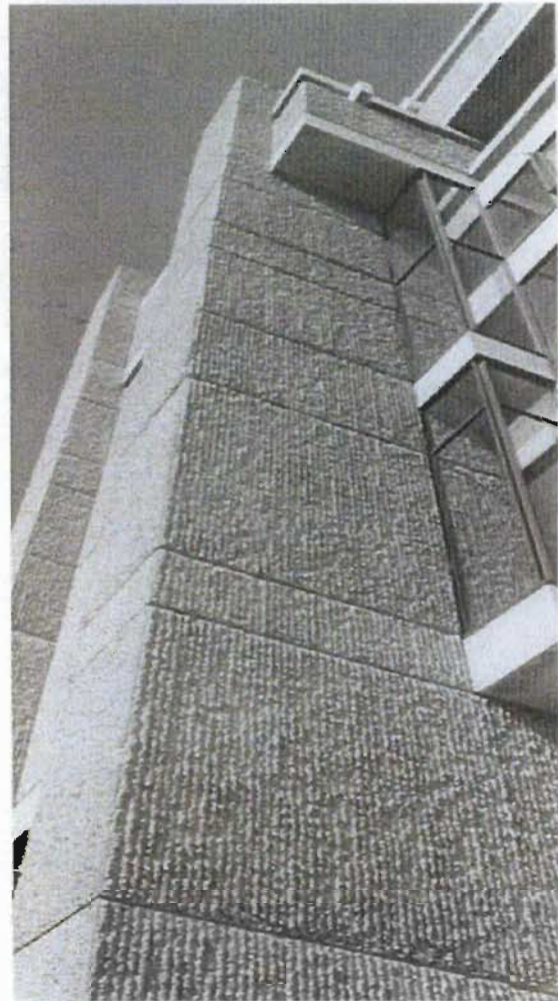

Fig. 4.1.6 *Detail of concrete finish*
(Monk: 1999, 40)

Rudolph's design reflected its surroundings and incorporated space and light as its main features in an exciting, if somewhat traditional manner.

The design was illustrated by an exceptionally impressive set of drawings, "The graphical quality and the large number of these presentation drawings, produced in the course of designing this scheme, are probably without parallel for any other modern building." (Monk, 1999: 41-42)

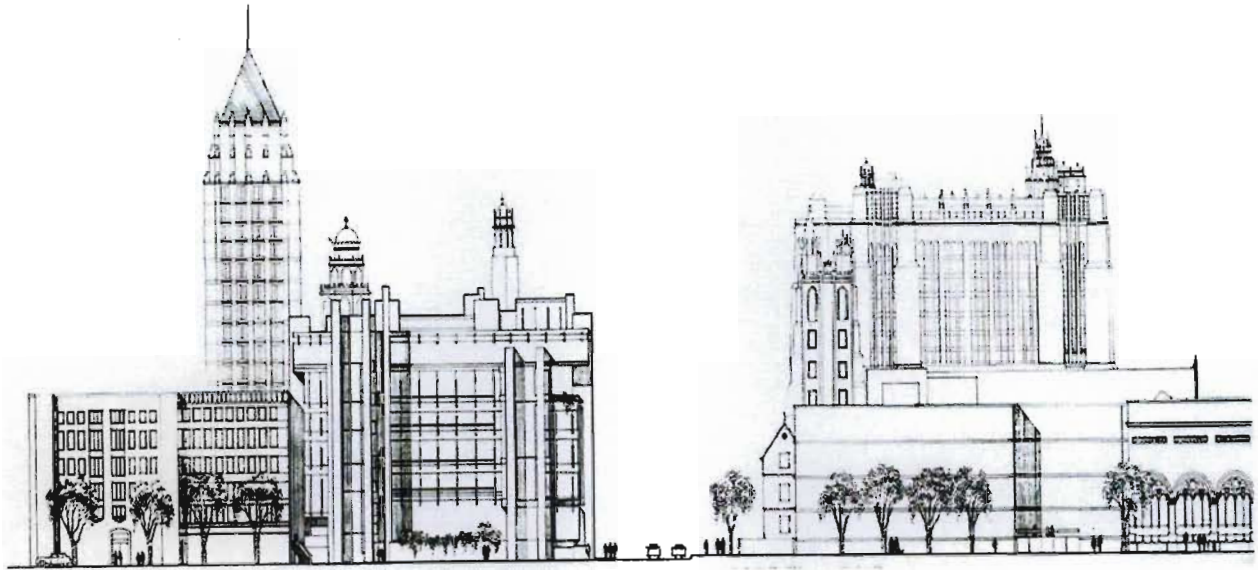

Fig 4.1.7 Chapel St elevation incl. context,
Monk: 1999,40

Included were single point perspective sections, drawn to demonstrate the internal character of Rudolph's scheme, a central volume of space and light. (Fig 4.1.8)

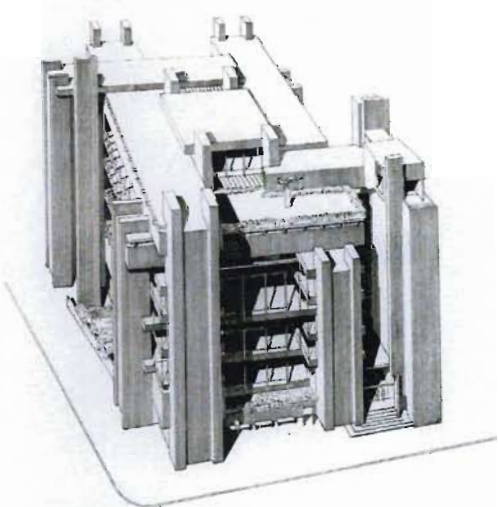

Fig 4.1.9 External perspective, *Monk: 1999, 38*

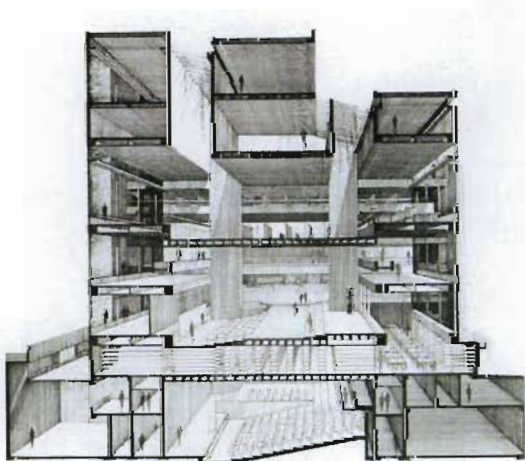

Fig 4.1.8 Cross section in perspective, *Monk: 1999, 38*

4.1.7. Negative aspects of the design

Rudolph had said he believed students from all years would benefit from working together in the same environment, and could learn from listening to the live examinations of other students work. It was from this, education motivated basis, that he designed the large central teaching volumes in both the

architects' and artists' spaces. In reality, these large volumes were rarely used. Students and staff found them too public, too noisy and poorly lit.

Thus, this building's legendary status is unfortunately not due to its importance as a pioneer of Late Modern American Architecture, but instead its rejection. Its initial praises were soon forgotten as students and staff began to discover technical and functional difficulties with the building. Not only did they decide they couldn't work easily in the vast open spaces, they also considered the architecture rather harsh and brutal, and did not appreciate the extensive use of abrasive textured concrete.

In 1967, just as frustration was reaching a climax, the top two floors were gutted by a fire. Due to the resentment felt toward the building, the cause of the fire seemed suspicious, and although the fire officer's report found it to be an accident, the idea that it was more malicious was never forgotten.

When repairs were made after the fire, the university carried out a refurbishment programme to create more practical rooms. This involved the subdivision of the large open

spaces with partitioning, and as a result, extensive use of artificial lighting.

As a result of the alterations, Rudolph's key concept of space and (natural) light was lost, and for many years afterwards he could not even bring himself to go into the building and refused to speak about it publicly.



Fig 4.1.10 *The oversized central volume where students felt uncomfortable working, Monk: 1999, 38*



Fig 4.1.11 *East (entrance) façade, Schwab: 1970, 125*

4.1.8. Conclusions towards the design of a KZNIBE

- Site prominence

The prominence of the Art and Architecture building's site was a major contributing factor to its extraordinary presence and distinction.

Rudolph skilfully manipulated the corner by projecting one of his colossal towers out to the pavement. As a result the building appears to be launching itself out towards the corner, aggressively imposing its gravity and commanding respect. (Fig 4.1.12)

This characteristic of the building has largely contributed to peoples 'love – hate' reaction to it.



Fig 4.1.12 As seen from the corner,
Monk: 1999, 38

A prominent site would greatly assist the KZNIBE to achieve the necessary impact on society, which is crucial to its success. However one would need to be especially cautious not to create a building that alienates the public.

- An acknowledgement of neighbouring architecture

Rudolph is applauded for his careful consideration of buildings surrounding his site. His skilful response to Louis Khan's gallery contradicts the perceived egotistic nature of the Art and Architecture building.

The design process of the KZNIBE should involve a similar sensitivity and response to its surrounding buildings, whatever they may be. It demonstrates humility, which certainly improves the designs chances of been well accepted.

- Privacy gradients and hierarchy of space

A major cause of the initial rejection of the building was the enormous central studio volumes. Students felt uncomfortable and exposed working in such a public domain.

Of course Rudolph did this deliberately, but one has to question the wisdom of that decision. One cannot negate the sensibility of designing a well considered privacy gradient, or hierarchy of space.

If Rudolph had only reserved his large central volumes for public spaces like the entrance lobby, exhibition spaces and lecture halls, and rather created more private and intimate spaces for the students' studios, he may have avoided the massive negative reaction to the building.

Key: 2nd basement – ground floor

- 1 storage
- 2 metal workshop
- 3 toplight
- 4 plastics
- 5 class orderly
- 6 installations
- 7 electric vault
- 8 electrical switches
- 9 graphic drawing studio
- 10 picture storage
- 11 porter's storage
- 12 lecture room
- 13 wood workshop
- 14 mezzanine
- 15 photographic studio
- 16 lift motor-room
- 17 compositors
- 18 plan's design drawing office
- 19 architects' archives
- 20 darkroom
- 21 bookbinding
- 22 interior courtyard
- 23 void above
- 24 printing shop
- 25 studio
- 26 lift
- 27 readings room
- 28 entrance
- 29 hall
- 30 library
- 31 magazines
- 32 study
- 33 librarian

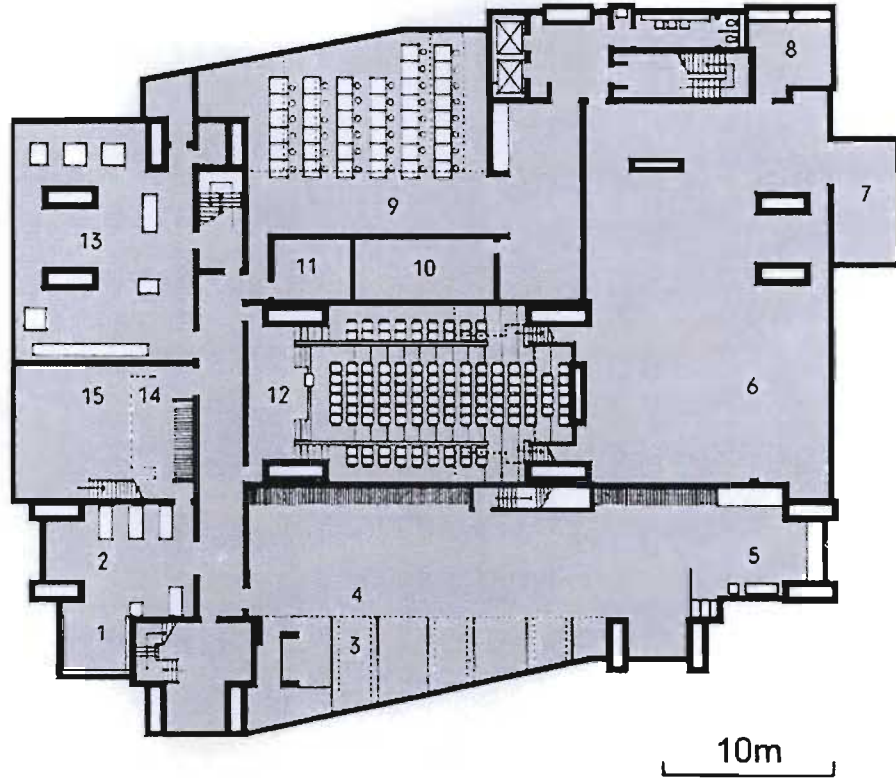

Fig 4.1.11 *Second Basement Floor Plan*

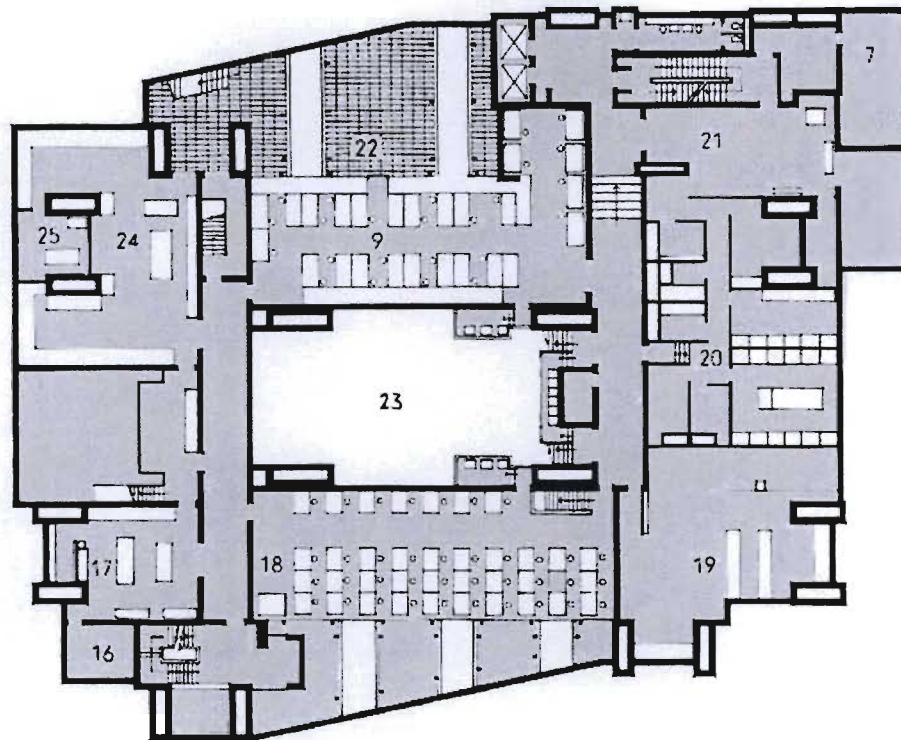

Fig 4.1.12 *First Basement Floor Plan*

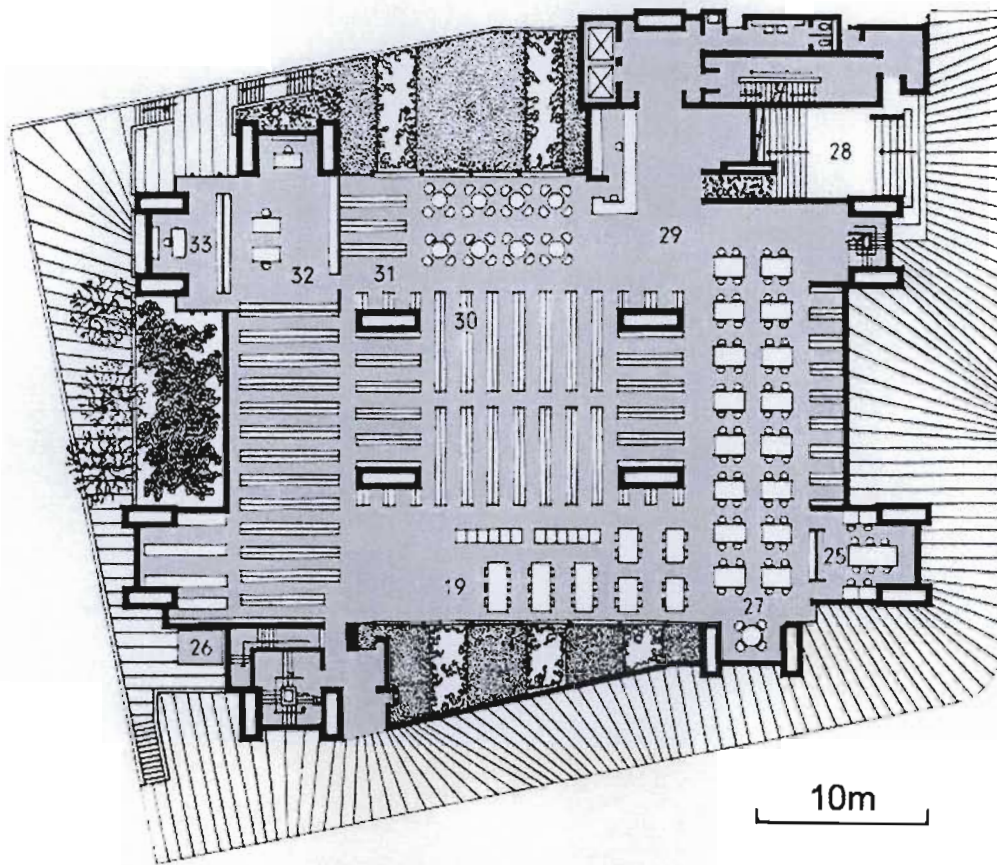

Fig 4.1.13 Ground Floor Plan

Key: 1st floor – 6th floor

- 1 reception
- 2 skylight
- 3 exhibition
- 4 classroom
- 5 void above reading room
- 6 mezzanine library
- 7 kitchen
- 8 lounge
- 9 exhibition room with 'Jury-alcove'
- 10 conference room
- 11 offices
- 12 secretaries
- 13 assistants
- 14 bridge
- 15 anteroom
- 16 dean
- 17 rehearsal hall
- 18 seminar
- 19 jury
- 20 drafting room
- 21 model construction
- 22 tuition
- 23 sketches
- 24 painting studio
- 25 workroom
- 26 storage
- 27 terrace
- 28 guestroom
- 29 lifedrawing

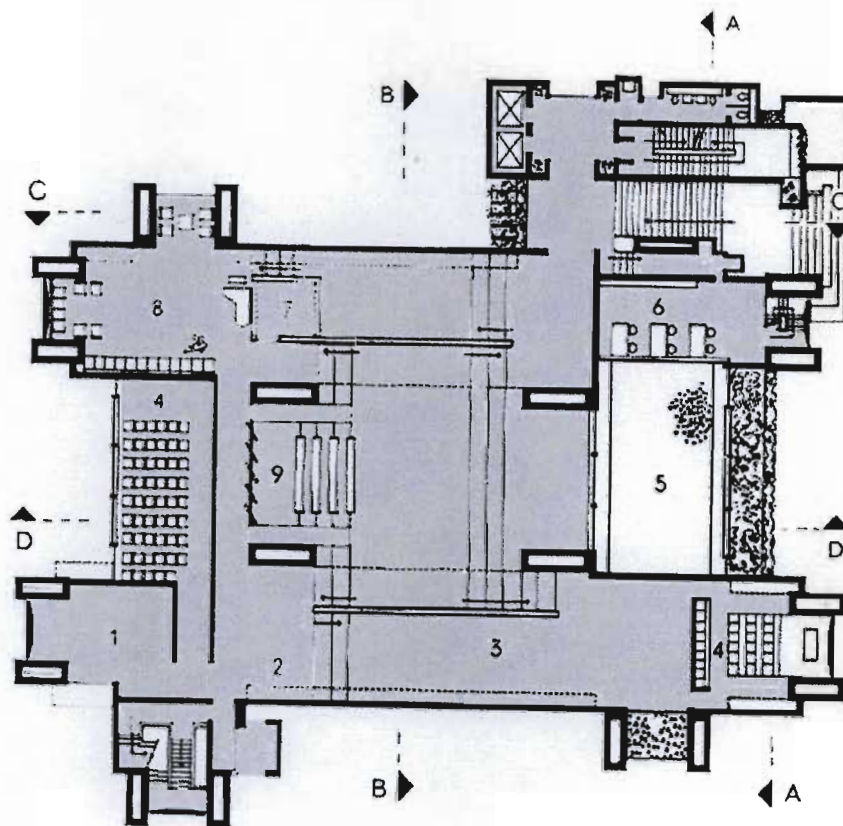

Fig 4.1.14 First Floor Plan



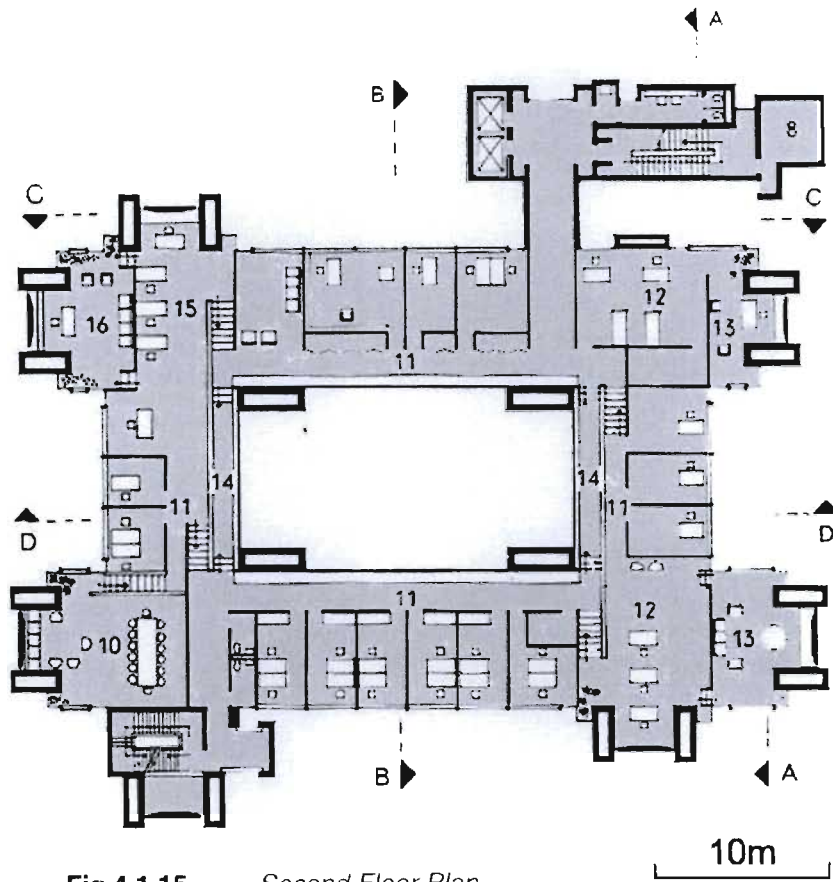

Fig 4.1.15 *Second Floor Plan*

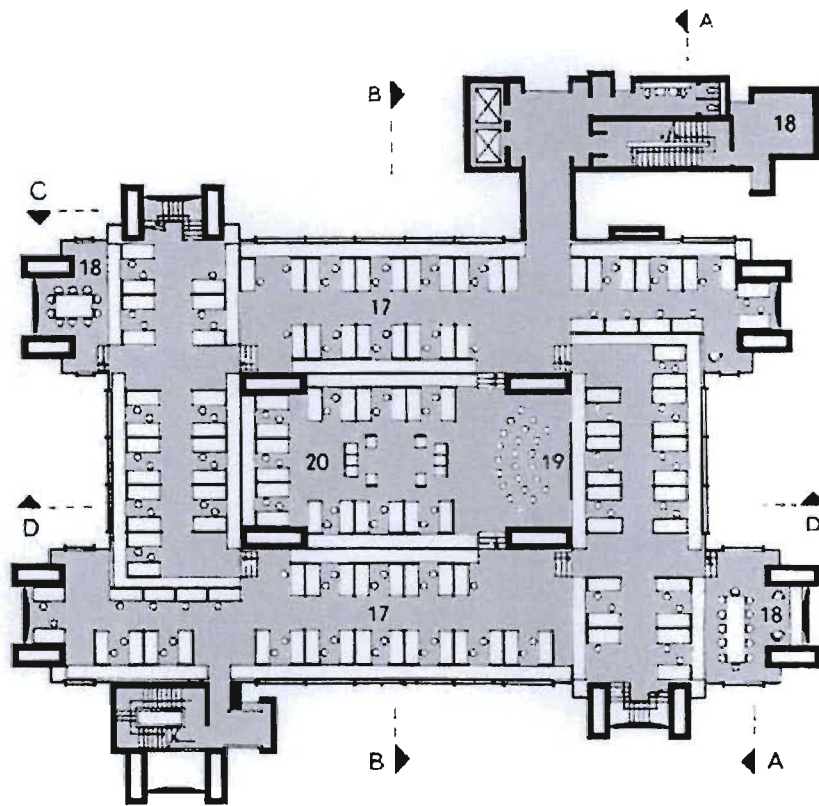

Fig 4.1.16 *Third Floor Plan*

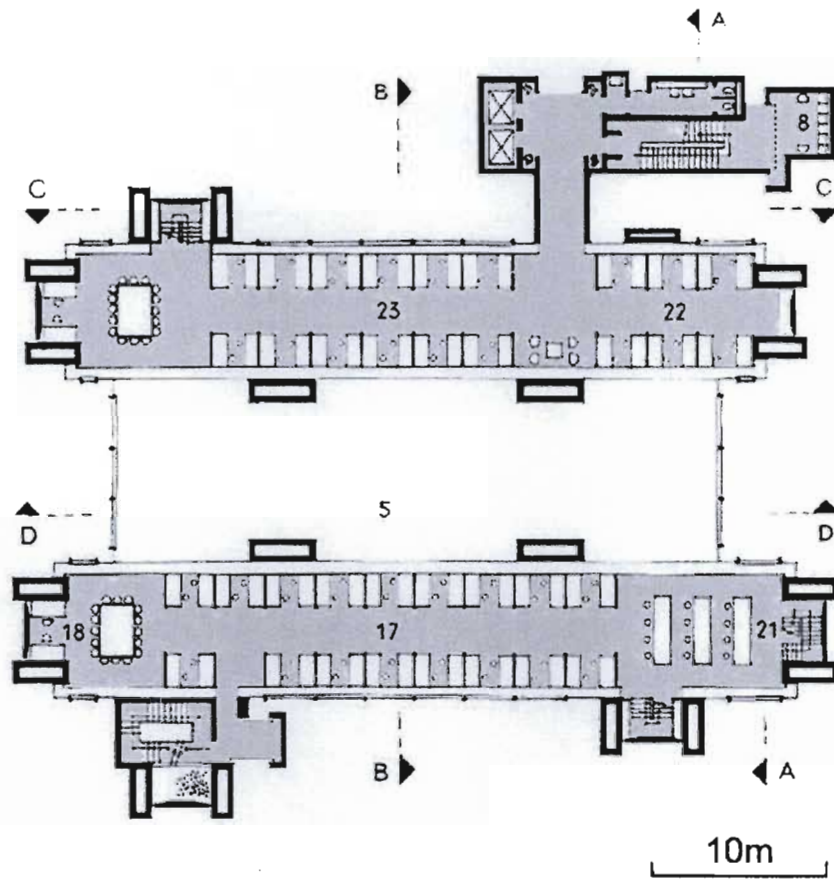

Fig 4.1.17 Fourth Floor Plan

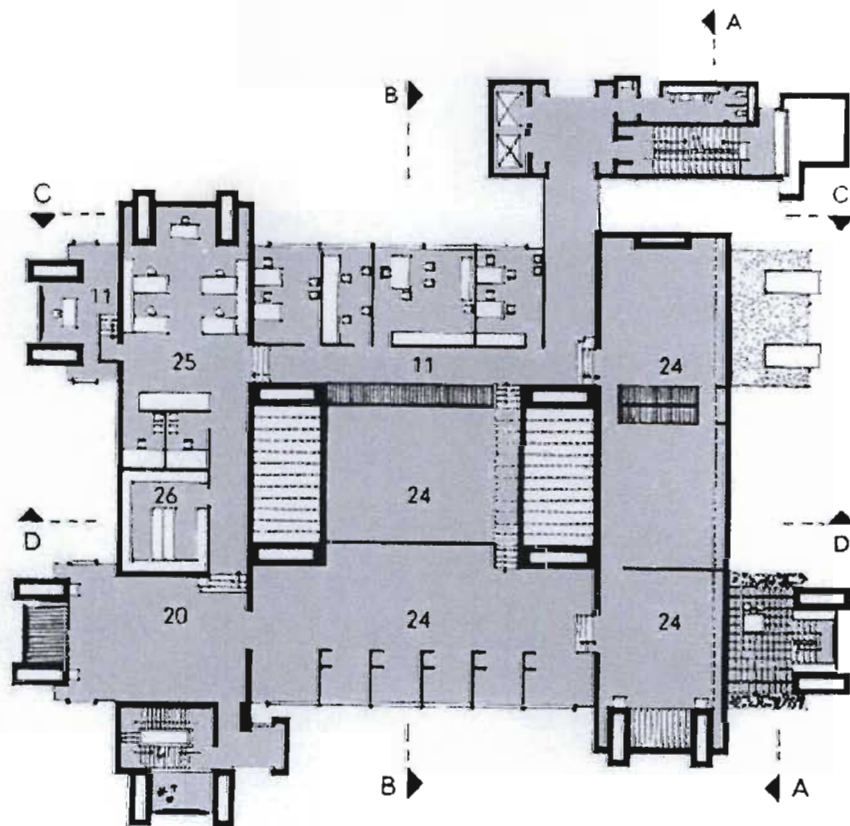

Fig 4.1.18 Fifth Floor Plan



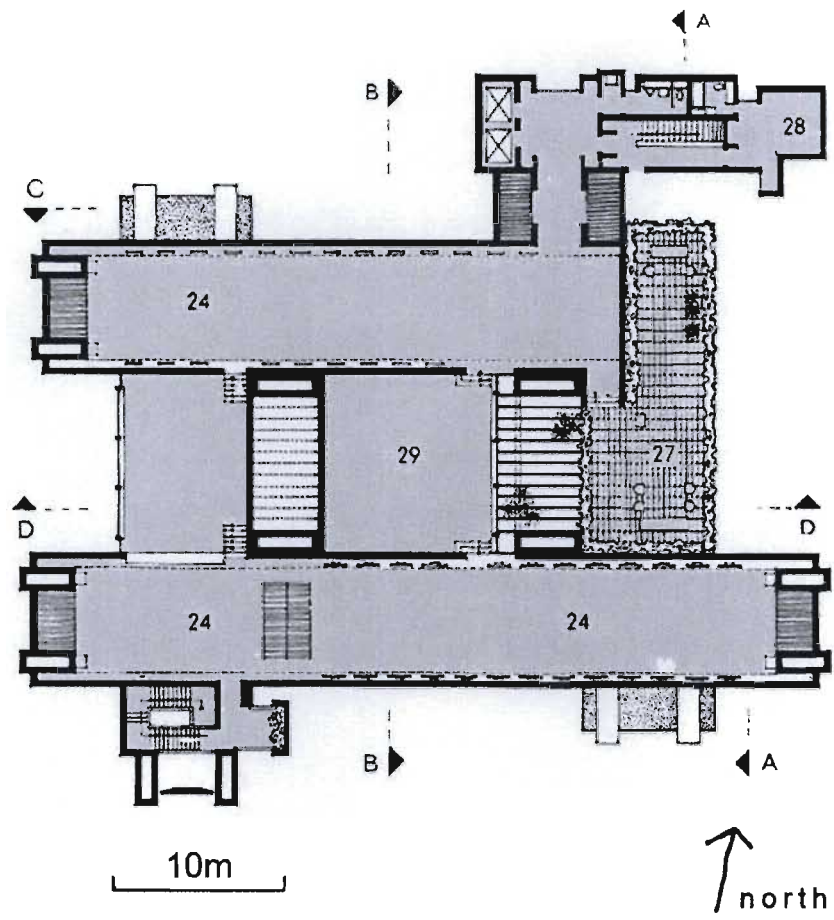

Fig 4.1.19 *Fifth Floor Plan*

(All plans sourced from Monk, 1999: p126-7)

4.2. The Oporto School of Architecture – Alvaro Siza – 1995

4.2.1. An introduction to the project

Alvaro Siza's Architecture School at Oporto in Portugal, is considered to be one of the internationally acclaimed architect's greatest works. It sits high on a terraced site, with views over the estuary of the Douro River. The tower-like structures on the lower terrace are "like four imposing totemic figures that seem to scrutinize and control the territory." (Domus, 1995:14) Just adjacent to the school is the historic Quinta da Povoá estate which accommodated the architecture school before its expansion. The estate houses an earlier project by Siza from 1985, the first-year Carlos Ramos Pavilion... clearly a precursor to the white sculptural structures that were to arrive ten years later.

4.2.2. The brief

The brief was to design a school of architecture that could function on its own, a complete package that would not have to depend on facilities on the adjacent university campus. It was to be designed to accommodate 500 students and a proportionate number of staff.

The accommodation schedule included specific venues for seminar rooms, classrooms, computer rooms, drawing rooms and studios. The four larger venues included the museum, library, auditorium and an amphitheatre. The teachers' offices and administration areas was another requirement. Siza also included a coffee shop and eating area in a separate pavilion, located towards the western gate.

4.2.3. Design concepts

Siza's scheme, which is particularly visible from across the river valley (Fig 4.2.1.), had to respond to a mixture of surrounding buildings. These included the large university buildings across the highway to the north, and the residential buildings (both historic and new) below to the south and west.



Fig 4.2.1 A view from across the river,
Domus, 1995:9

Interestingly, “Siza tackles the question of function by almost denying it. Noting specific characterises this building as public, and yet nothing specific denies its rather domestic mood.” (Domus, 1995:17) In scale Siza’s buildings relate more to the larger university campus buildings, whilst in proportion the four towers are more reminiscent of the residential apartments below.

Siza has created what appears to be a four of smaller disconnected tower buildings, placed in straight row on one side of the campus, and a long continuous structure on the other side. (Fig 4.2.2. & Fig 4.2.3)



Fig 4.2.2 The four ‘totemic figures’ overlooking the Douro river below, *El Croquis*, 2000:160



Fig 4.2.3 The central triangular space, *El Croquis*, 2000:163

These seemingly isolated towers are however all connected to each other, and the larger structure, by tunnels set 3 metres below a central plaza. These tunnels bind the whole complex together, and are designed wide enough to be used as exhibition spaces.

It seems that Siza’s design decisions are made from the inside out. The placement of windows, for example, are influenced by what he is trying to achieve inside, rather than a personal preoccupation to create some arbitrary external composition. Thus, “exploring the interior of these buildings, one realises that their apparent outward simplicity hides an unimaginable inner complexity... the variety of interiors – dynamic and static, brightly illuminated and dark, large and small, with direct and indirect light, regular and irregular shapes – creates a mixture of very dissimilar spatial sensations.”

(Domus, 1995:14)

This acute sensitivity to variations in the program, does however, produce the less obvious outer complexity of different heights and façade configurations.



Fig 4.2.4 *The approach to 'block B', (El Croquis, 2000:170)*

Despite a range of different sun-control fins and awnings applied around the complex, no doubt carefully calculated to enhance the quality of internal spaces, Siza's white facades still remain remarkably constrained.



Fig 4.2.5 *Although each tower/block shares the same restrained construction pallet, each has its own unique eccentricities, (El Croquis, 2000:167)*

Whilst he appears to make use of conventional materials and details, his pallet of materials used on the internal surfaces include exotic wood floors, marble in the foyers and stairs, and specially designed furniture for the classrooms, auditorium and library.

Skylights are used extensively to draw natural light into the main spaces, the skylight above the library is especially complex.



Fig 4.2.6 *A classroom on the third floor in 'block B' is enhanced by skylights and sensibly positioned windows, (El Croquis, 2000:182)*

4.2.4. Site characteristics

The site is unfortunately bordered on two sides by highway exits (with the highway to the north), thus careful consideration was required to best manage this potential noise problem. On its eastern border is the former historic estate of Quinta da Povoá. The terraced triangular site does however offer great views of the Douro River estuary and the surrounding residential buildings below.

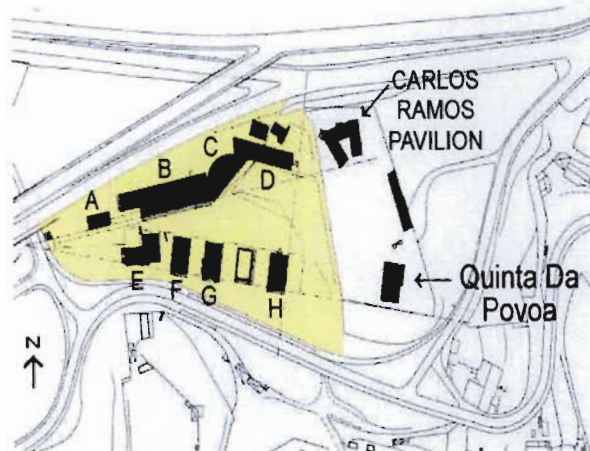

Fig 4.2.7 Site plan, (El Croquis, pg 160)

Siza's buildings appear to sit comfortably on the various terraced levels of the site, and interconnections between them work with ease. "As the configuration of space works with the existing terraced topography, minimum earth movement was required and extensive use made of the pre-existing stone walls and platforms." (Testa, 1996:156)



Fig 4.2.8 Circulation ramp in 'block B', (El Croquis, 2000:174)

4.2.5. Spatial arrangement of the accommodation

The school has a total floor area of 8340m². The buildings have been laid out to create a triangular meeting space in the centre. The space is created between two wings which converge towards the west, and is closed off on the East by the stone boundary wall of the neighbouring estate. The northern wing, a single continuous structure made up of three segments (B, C and D), acts as a visual and acoustic barrier against an adjacent highway. The southern wing consists of the four tall, seemingly disconnected structures (E, F, G and H), each placed several meters apart in order to allow views between them from the central space and the northern wing.

The entrance to complex, the 'Western Doorway', is located at the converging point of the two wings, and is marked by a coffee shop pavilion (A).

The three segments of the northern wing are, 'B', which consists of an amphitheatre, administration, drawing rooms, computers and seminar rooms. 'C' is a semi-circular exhibition gallery, and 'D' includes a library and auditorium. The structures 'E', 'F', 'G' and 'H' accommodate the studios, classrooms and teachers rooms.

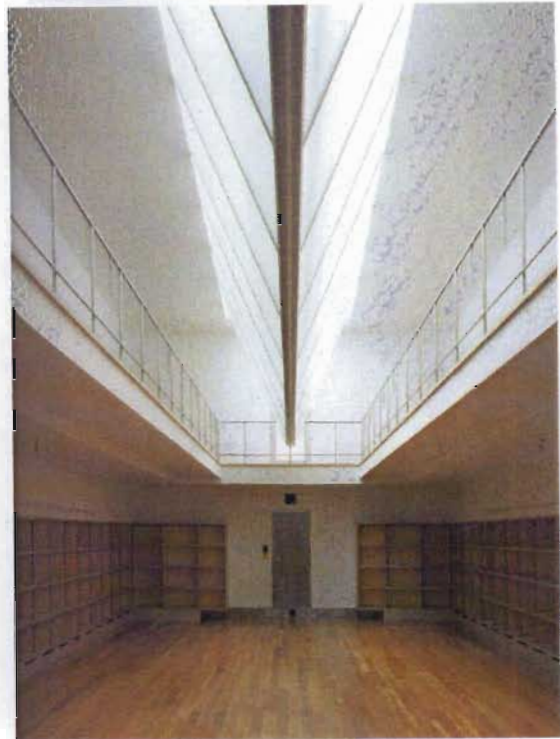

Fig 4.2.10 A V-shaped skylight projects down into the library's upper volume, (El Croquis, 2000:179)

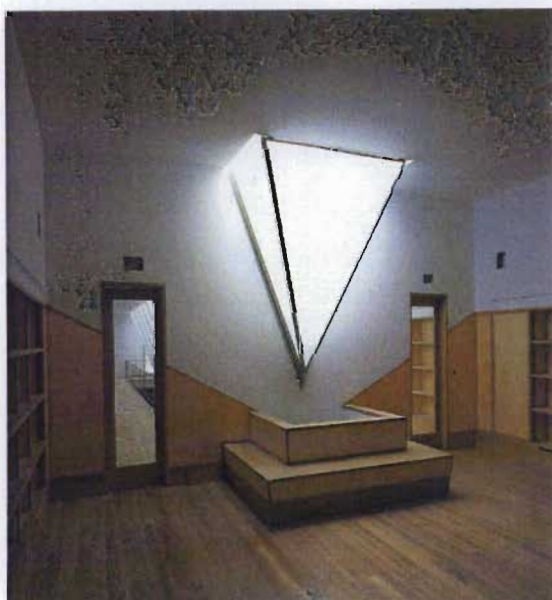

Fig 4.2.9 Upper level of library, (El Croquis, 2000:177)

4.2.6. Positive aspects of the design

- **A sensible division of buildings in tune with the programme**

"The academic structure is reflected perfectly in the division of buildings." (Domus, 1995:17) Siza has sensibly grouped those facilities which function most directly with each other. By doing so, he has created clusters of similar activities. These clusters are more secure and easy to manage, as private areas are separated from more the more public areas.

- **The buildings are arranged around a central social space**

"Great attention is paid to the school as a special place of aggregation and exchange." (Domus, 1995:17) The arrangement of buildings into two long wings, placed in a 'V' formation, creates a courtyard in the heart of the complex. (Fig 4.2.3)

These social spaces are of course of crucial importance in a school of architecture, as the discipline is one that revolves around discourse.

4.2.7. Negative aspects of the design

- **The buildings don't connect well with the outside courtyard**

The doorways connecting the various buildings to the central courtyard are particularly insensitive as entrances. These transitions between inside and outside seem carelessly abrupt.

In many instances one steps directly over a threshold into a building, with no shelter from rain provided over the entrance.

- **The campus could be accused of neglecting the public**

Unlike other schools of architecture, this rather isolated campus has appeared to disregard any engagement with the general public. This stems from the fact that the campus has neither been placed on an established university campus, nor planted within an active urban environment. It seems a shame that the campus has missed the opportunity of public interaction, and thus, may only be appreciated by the architecture students and staff.

4.2.8. Conclusions towards the design of a KZNIBE

- **Massing**

The massing or form of the building should clearly reflect the programme. Rather than squashing the institute into a single form, forcing its various facilities to be accommodated on standardised floors, each component should be housed in a form specific to its unique function. These various forms would then be arranged, creating the overall configuration of the institute.

- **Social space**

A stimulating social space, with the ability to cater for functions, should form the heart of the complex.

- **Urban environment**

The KZN Institute for the Built Environment should be placed in an urban environment with a mixture of residential and commercial buildings, thus preventing the kind of isolation that the Oporto school suffers from.

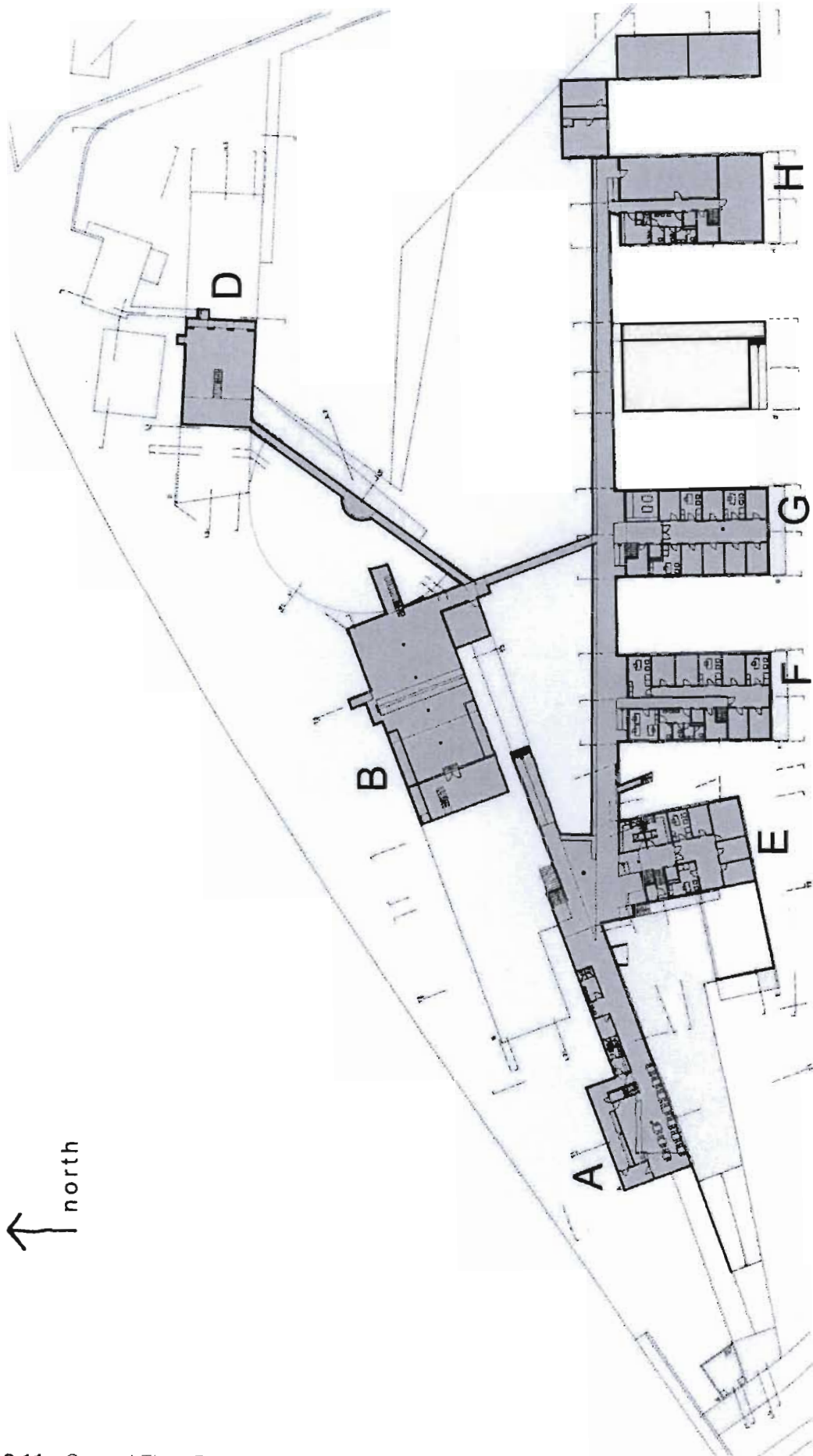

Fig 4.2.11 *Ground Floor Plan*

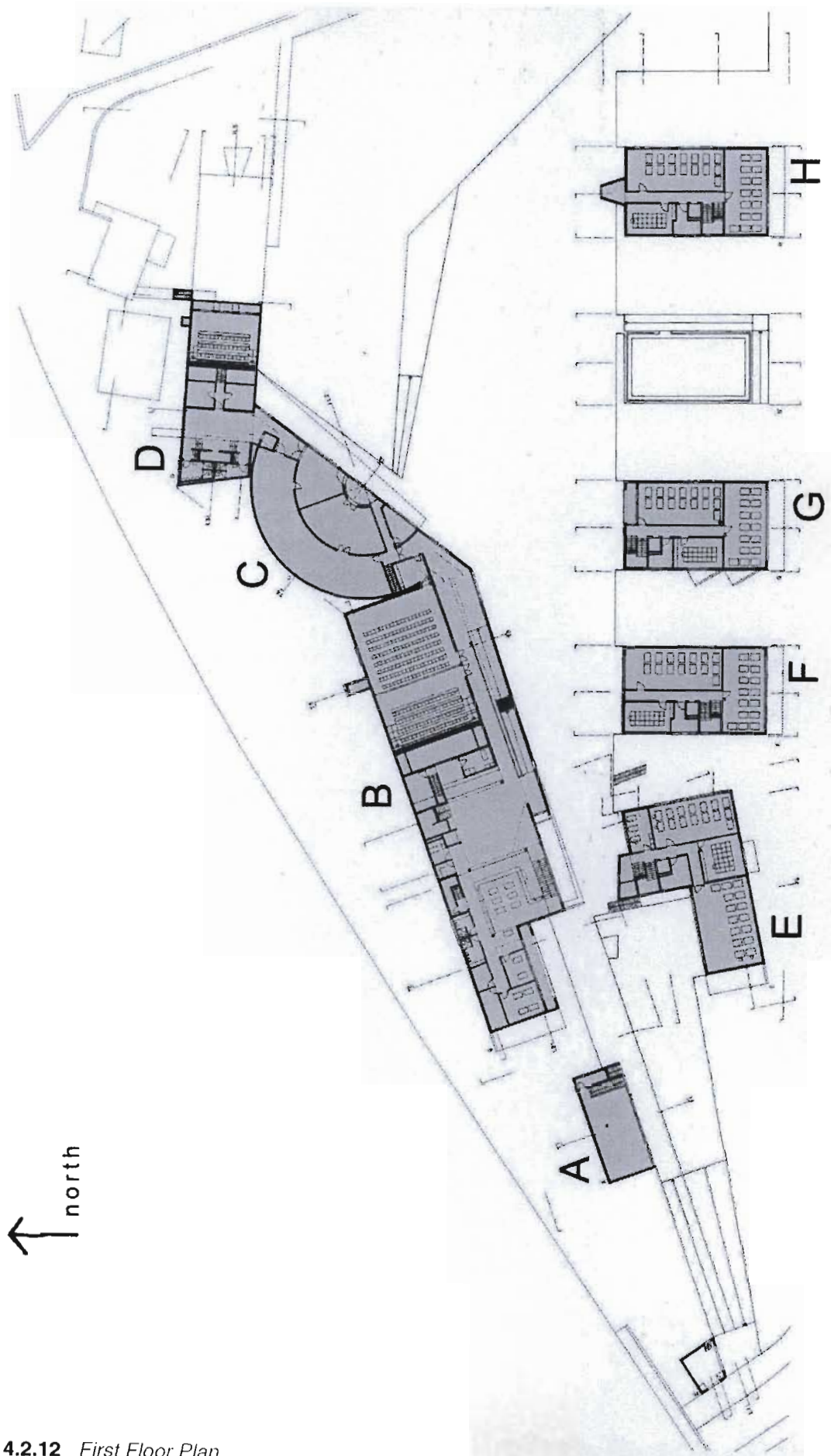

Fig 4.2.12 *First Floor Plan*

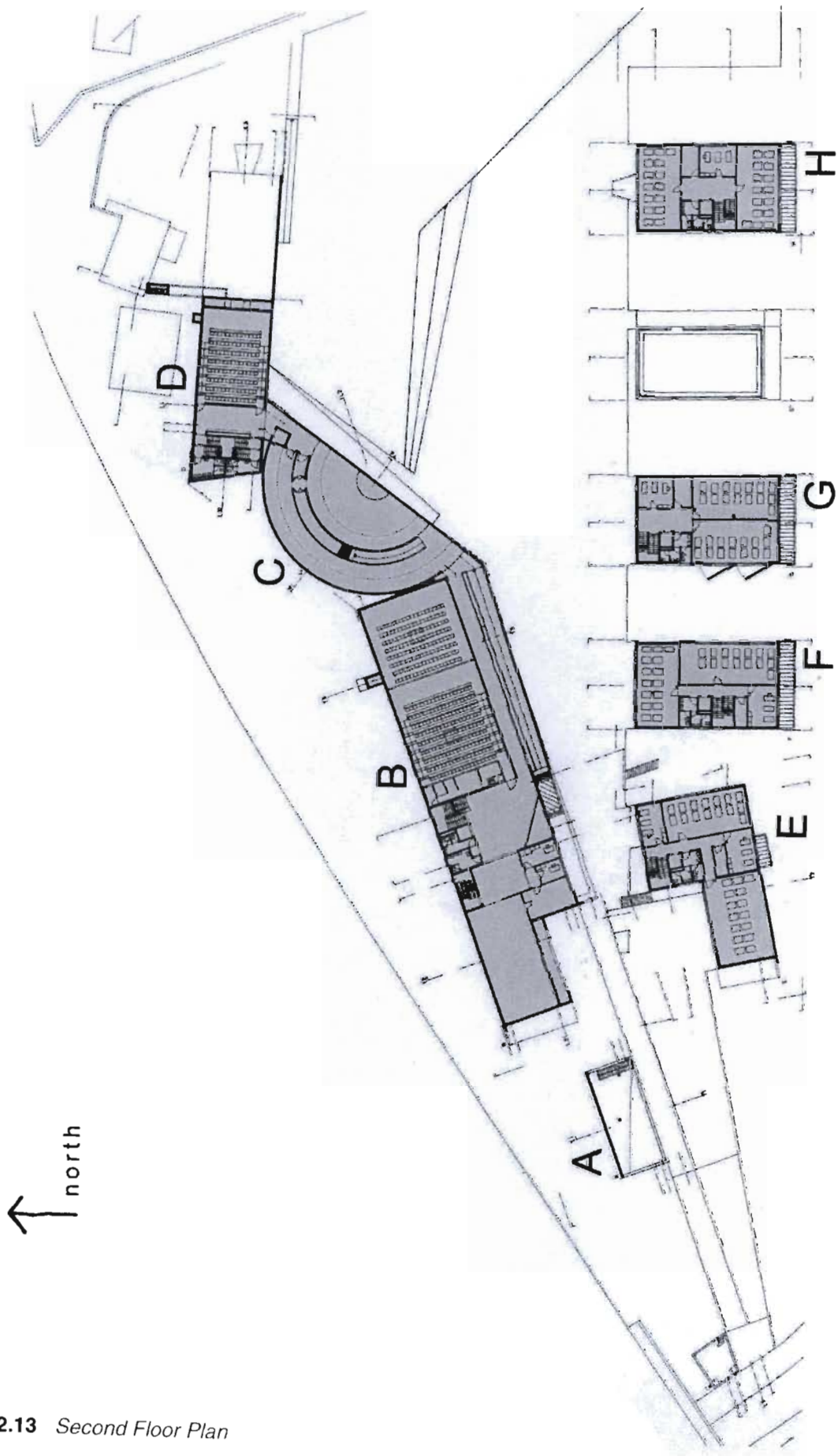

Fig 4.2.13 Second Floor Plan

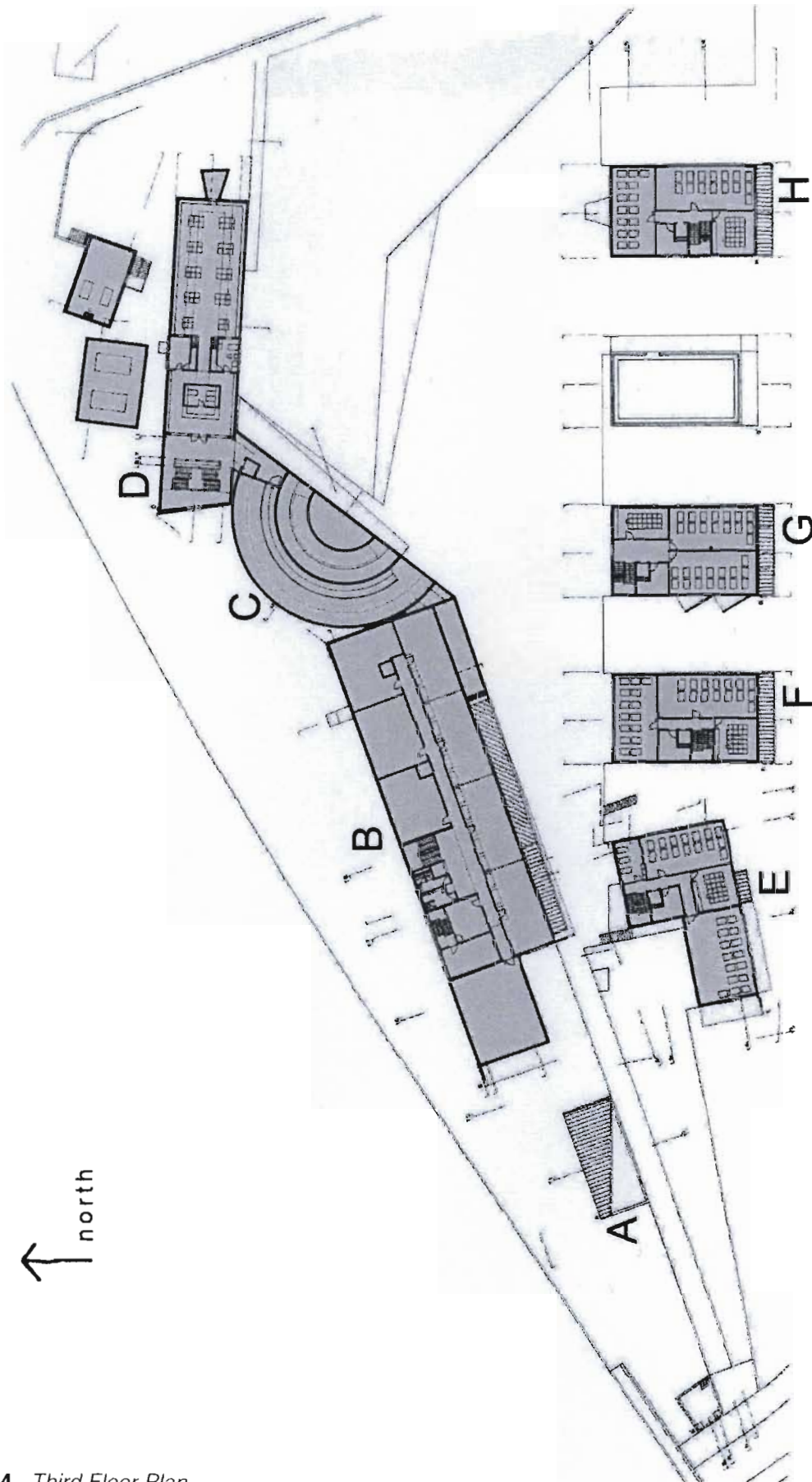

Fig 4.2.14 Third Floor Plan

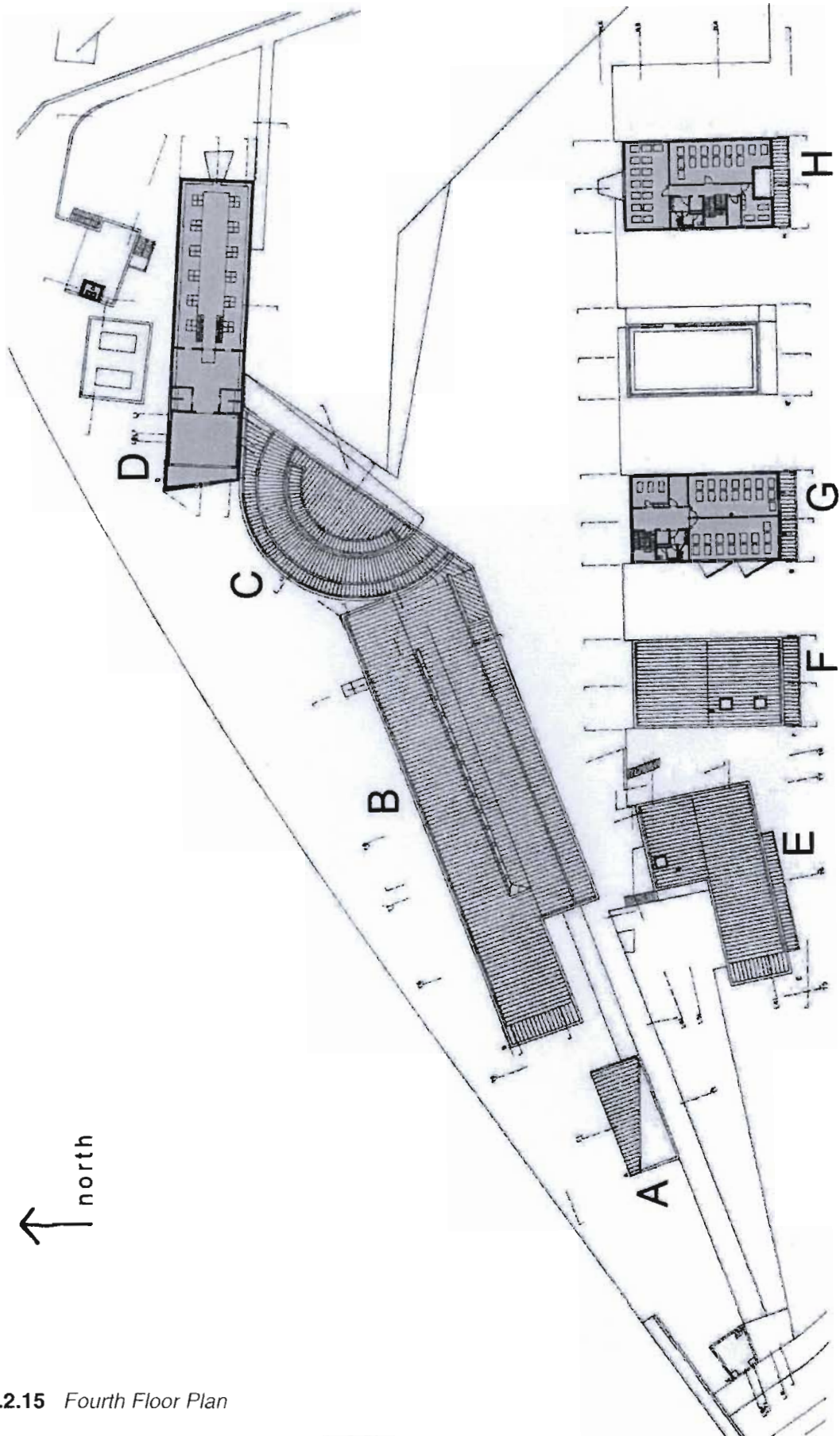

Fig 4.2.15 *Fourth Floor Plan*

(All plans sourced from Alvaro Siza 1958-1994)

4.3. The Architecture Foundation's Centre for Architecture, London – Zaha Hadid – 2008

4.3.1. An Introduction to the Project

The 'Architecture Foundation' is considered the United Kingdom's leading independent architecture centre. Each year they are responsible for presenting an extensive programme of talks, events, debates, exhibitions, competitions and other projects.

The foundation's role is to promote and encourage the best in contemporary architecture, and to bring it to a wide public audience.

In 2004 an international design competition was initiated to draw out the most captivating scheme to house a new 'Centre for Architecture' in central London, to be run by the 'Architecture Foundation'. This extraordinary project, initiated and funded by 'Land Securities' as part of their 'Bankside 1 2 3' development, is a key element in their regeneration of the Southwark district.



Fig 4.3.1 Site plan, (Architecture Foundation)

The competition, which attracted over 200 entries, was ultimately won by the Pritzker Prize winning architect, Zaha Hadid.

Since her commission in January 2005, Hadid has made some adjustments to her winning design, and plans are in motion to complete the project towards the end of 2008.



Fig 4.3.2 Zaha Hadid's original winning scheme, (Architecture Foundation)

4.3.2. The brief

The competition brief was to design a 'Centre for Architecture' that could stimulate creative ideas, a place of energy and activity. It requested a building that would have "the qualities of a billboard and a chapel, which could combine a powerful relationship to the street with more contemplative exhibition spaces inside". (Architecture Foundation: 2005)

The accommodation was to include a cafe/bar, exhibition space, space for lectures or presentations, and offices of the 'Architecture Foundation'.

Since, the centre would double as both an energetic, public social space, as well as the foundation's administrative headquarters, its planning demanded a well considered privacy gradient.

4.3.3. Design concepts

In the words of Zaha Hadid, "the building is designed as a sculptural element, mysterious and intriguing and not referable to traditional architectural typologies.

As a solid metal-mirror clad diamond the Architecture Foundation Building generates a new point of interest within the Bankside 1 2 3 development." (Architecture Foundation: 2005)

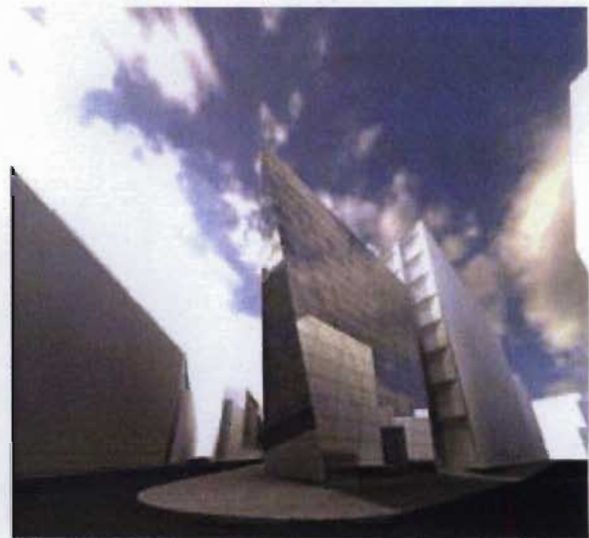

Fig 4.3.3 Conceptual perspective, (revised scheme) view of corner, (Architecture Foundation)



Fig 4.3.4 Conceptual perspective, view of glazed atrium, (Architecture Foundation)

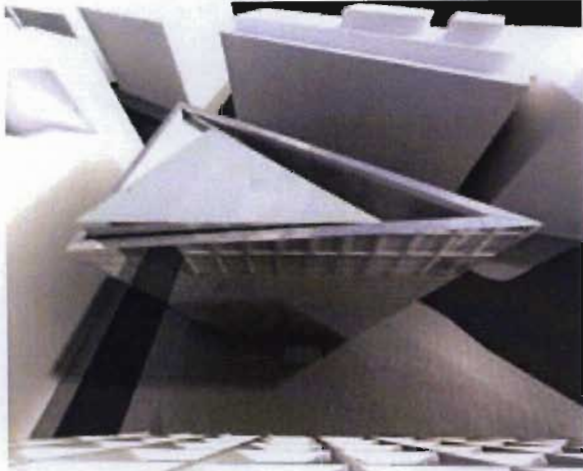

Fig 4.3.5 *Conceptual perspective, view from above, (Architecture Foundation)*

Hadid's response to the triangular corner site is a multi-faceted diamond-shaped building, conceived as a pure, yet dramatic architectural statement. As a result it appears more like abstract urban sculpture, than a functional building. She does however believe that the shape of the building is a direct consequence of the urban environment in which it sits, and the relationships it establishes with its surroundings.

The design merges the traditionally independent structural elements: floors, walls and roof, into a single continuous structural element. The building thus exploits the full potential of its reinforced concrete structure, displaying a celebration of architectural ingenuity.

The structure's mirrored cladding was not only conceived with the intention of presenting the

building itself as an example of contemporary architecture, but is also intended to reflect the architectural quality of the built environment in central London. Furthermore, not only does its surface literally reflect the city around it, but also figuratively, as within it contains a 'reflective' exhibition of English architecture.



Fig 4.3.6 *Perspective, view of corner from across Southwark Street, (Architecture Foundation)*



Fig 4.3.7 *Perspective, view of entrance from across Southwark Street, (Architecture Foundation)*

4.3.4. Site characteristics

The location for the Architecture Foundation's new 'Centre for Architecture' in central London is on a prominent corner site at the

intersection of Southwark and Great Guildford Street's. The site not only offers great exposure, but is also strategically positioned to encourage people from the nearby cultural and tourist attractions on the Thames Bank towards the heart of Southwark.

Thus, as Southwark is fast becoming a cultural hub, the Architecture Foundation's centre will become part of an existing and developing precinct, which already includes the Tate Modern Gallery and the Globe Theatre.

The site for this relatively small building is however challenging, in that it is surrounded by comparatively much larger, higher and thus potentially, overwhelming buildings. This created a possible conflict of interest, as the brief required a landmark building, which would have a far greater presence than those around it.

4.3.5. Spatial arrangement of the accommodation

The Centre's accommodation is arranged on four levels, linked by an atrium that soars up from its entrance. Not only does this atrium act as an impressive entrance foyer, but its full height glass-wall also establishes a powerful relationship between the exhibition spaces and the street outside.

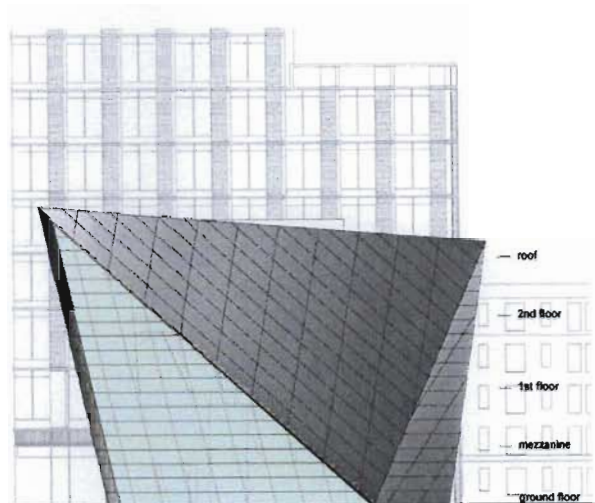

Fig 4.3.8 Southwark Street elevation, (Architecture Foundation)



Fig 4.3.9 Entrance foyer, conceptual perspective, (Architecture Foundation)

The vertical circulation is positioned in the northern corner of the building. A circulation lobby has been placed on each floor, with a single stair and lift on either side of it. As all the various spaces above ground floor are only accessible from these lobbies, their access may be restricted if need be.

Exhibition spaces have been spread from the ground floor, to the mezzanine and first floor. The exhibition area on the first floor has been

designed to double as a presentation or lecture venue. A small café/bar, to serve visitors during functions, has been positioned on the ground floor under the mezzanine, adjacent to the entrance lobby.

The exhibition space on the mezzanine level acts like balcony, overlooking the entrance below. Substantial toilet facilities for visitors are also positioned, rather sensitively, towards the back of this mezzanine level, with separate access from the stair/lift lobby. Administrative offices and a boardroom for the Architecture Foundation are sensibly situated on the top, most private floor.

4.3.6. Positive aspects of the design

- **An appropriate site**

The corner site at the intersection of Southwark and Great Guildford Streets offers the centre extraordinary exposure. This is hugely significant to a public building of this nature, when success depends largely on its ability to attract public interest.

- **The design achieves landmark status**

Due to the design's unique character, it creates a major presence in a potentially

overwhelming context of far larger buildings. It's a bold element in an otherwise rather conventional urban landscape. There is a tension formed between the structure's powerful sculptural mass and the lightness of its reflective skin, which adds to its peculiarity and interest. These features, coupled with the prominence of the site, produce an iconographic building that achieves landmark status.

- **Sensible planning**

Hadid has created a progression of levels from the lively public areas on the lower floors, to the private office space at the top floor. This privacy gradient from the ground to the third floor, not only improves security, but also makes sense for users of the building. Most people will only use the lower two floors, whilst progressively less people will visit the upper floors, thus minimising the use of the lift and stairs.

- **A vibrant atrium space**

The glass-walled atrium not only maintains a link between spaces on various floors, that would otherwise be isolated and disconnected from each other, but also creates a powerful relationship between the exhibition spaces and the street outside.

As a result of connecting the building as a whole, users are able to easily orientate themselves, whilst being aware of other activities occurring in the centre.

4.3.7. Negative aspects of the design

- **The building's abstract image fails to communicate authentic contemporary architecture**

Although the director of the Architecture Foundation, Rowan Moore, believes "Zaha Hadid's new building will be both a venue for communicating architecture to the public, and a powerful expression of architectural imagination," one has to doubt how successfully such an abstract structure can communicate authentic contemporary architecture to a lay public audience. Instead it's more likely this 'mysterious element' will only further mystify and puzzle an already confused public. Thus instead of developing a public understanding and appreciation of contemporary architecture, ironically public perceptions of it may only be damaged further.

Unfortunately, it is human nature to reject that which we struggle to grasp, and instead of the centre drawing positive interest, it may only fuel conservative counter reactions.

- **Rather making a bold and confident architectural statement, the structure hides beneath its reflective skin, shy and bewildered by its responsibility**

The structure's reflective skin misses the awesome opportunity of actually being architecture, rather than just reflecting it. The mirror cladding lacks integrity, concealing the true nature of the buildings reinforced concrete structure beneath. Furthermore, instead of revealing the position windows, which should have been designed sensitive to orientation and function, Hadid seems ashamed of such realities, choosing rather to secretly mask them under the anonymous cladding.

- **The building has no room for expansion, and is limited in its ability to adapt to different uses**

In the likely event of the Architecture Foundation growing larger than its new facility, it has does not have the option of expanding the building. The foundation's only option would then be to move on to a new home. The building would then have to be used by some other organisation; this would however be difficult, as the spaces are purpose designed and clearly inflexible.

4.3.8. Conclusions towards the design of a KZNIBE

- **Site exposure**

Choose a central site which offers great exposure. As is shown in this example, corner sites are most preferable. This will assist in devolving a structure with landmark status.

- **Cultural Precinct**

Choose a site positioned within an existing or developing cultural precinct. A family of cultural attractions has more strength than one that stands alone.

- **Connect the exhibition space to the neighbourhood**

Create a powerful relationship between vibrant and attractive exhibition spaces, and the world outside. This relationship will reinforce the building's intention to reach out to the general public, and encourage interest in the Built Environment.

- **Architectural language**

Acknowledge the building's potential impact on public perception, and create an architectural language which acknowledges and responds appropriately to this awesome responsibility.

- **Privacy gradients**

Acknowledge the duality a building, which has both especially public and private spaces. Design legible privacy gradients, which improve security and facilitate orientation with ease as well as logical circulation routes.

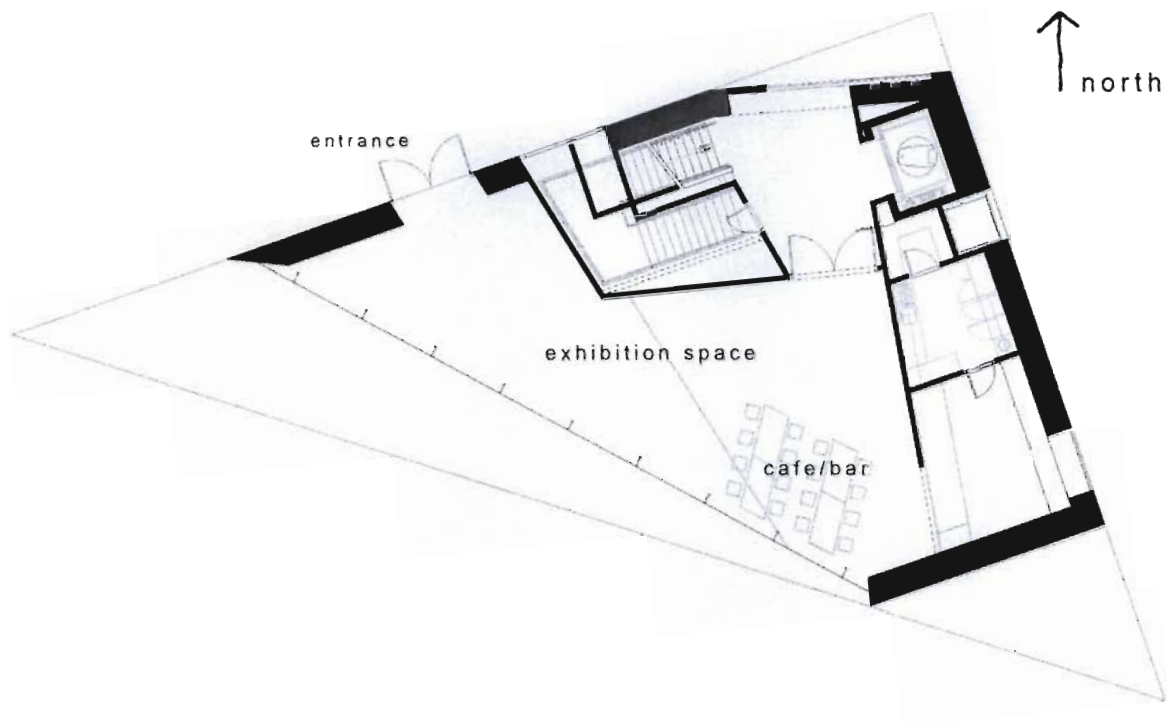

Fig 4.3.10 *Ground Floor Plan*

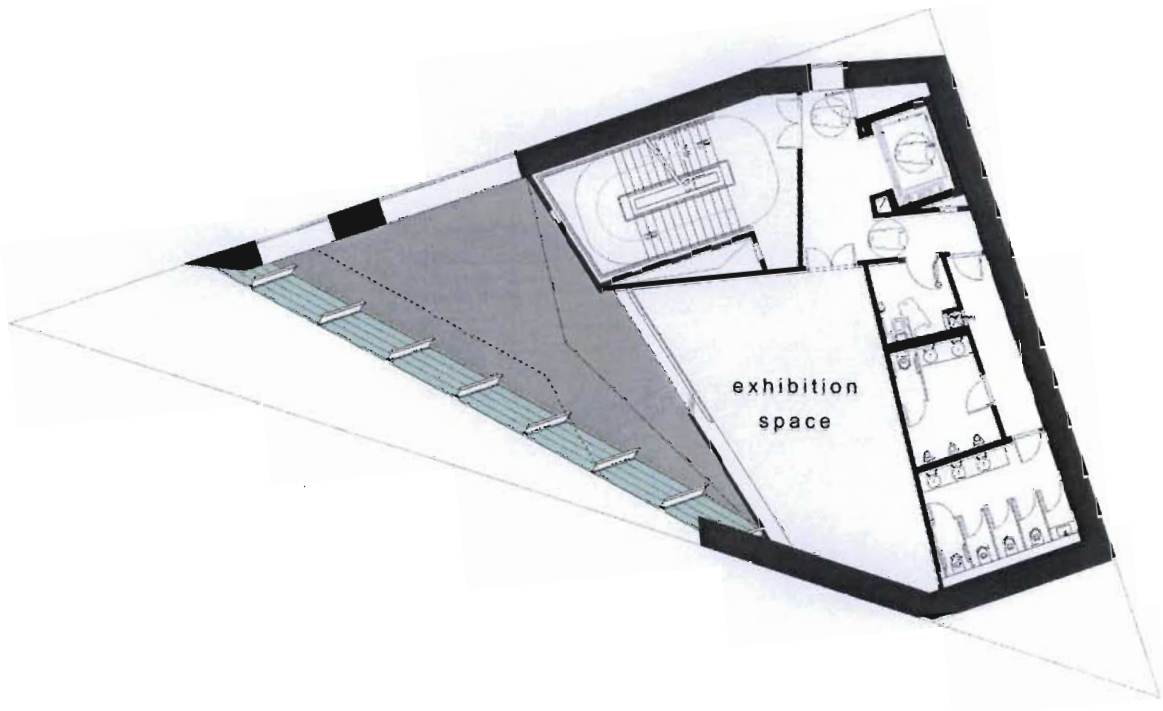

Fig 4.3.11 *Mezzanine Floor Plan*

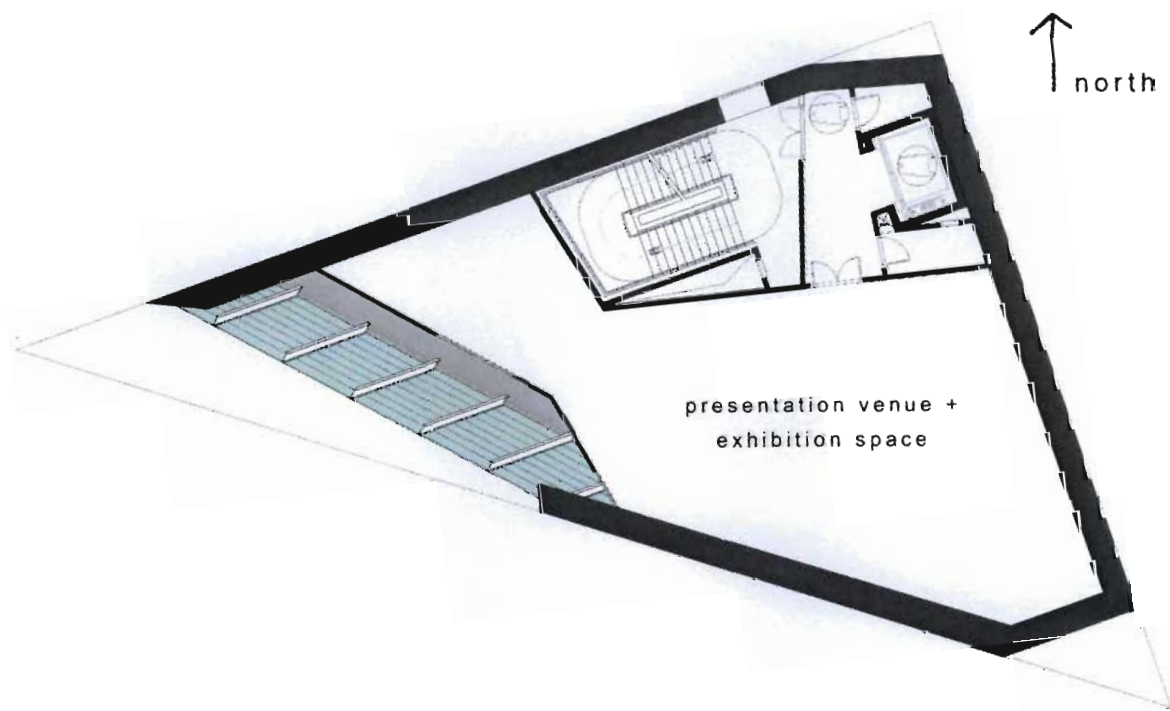

Fig 4.3.12 *First Floor Plan*

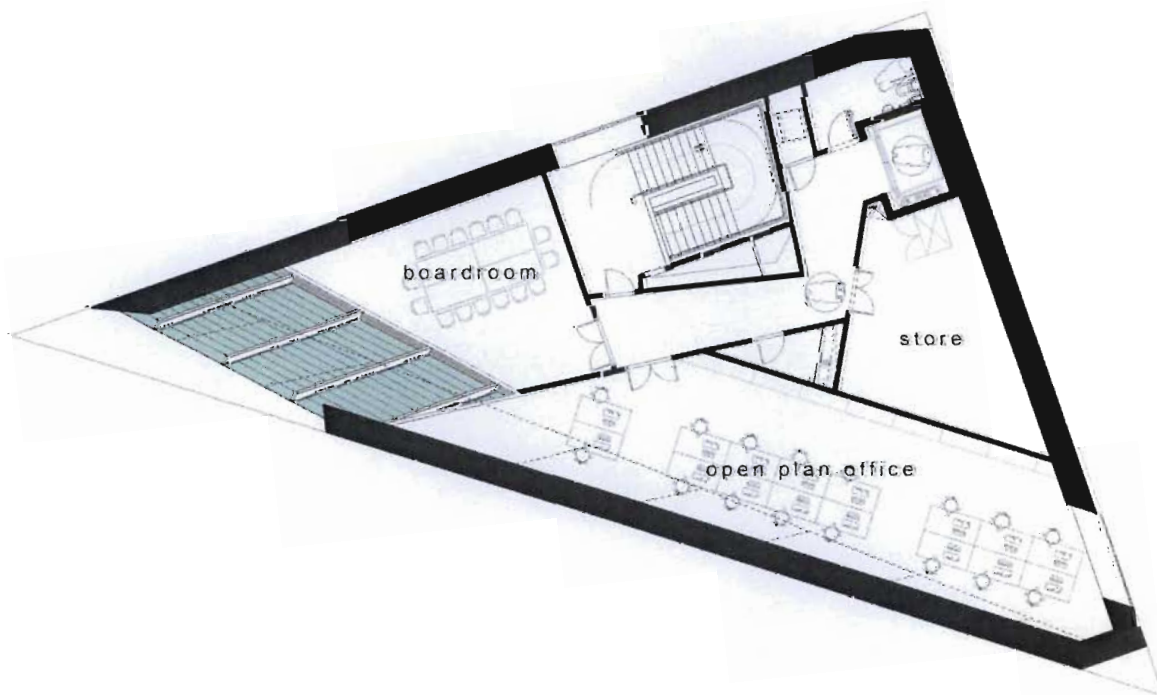

Fig 4.3.13 *Second Floor Plan*

(All plans sourced from the London's 'Architecture Foundation' website:
<http://www.architecturefoundation.org.uk>)

5.1. Case Study 1 – ‘Boukunde’ Pretoria School for the Built Environment

5.1.1. Reasons for Choosing the Case Study

- **A Multi-disciplinary School**

The Pretoria School for the Built Environment is one of very few multi-disciplinary schools, offering degrees in three disciplines: Architecture, Interior Architecture and Landscape Architecture. What makes the school particularly unique is that students in the various degrees are placed together and work on the same projects. Students then focus their projects according to their particular design discipline of study.

This aspect is especially relevant to this study, as the design school component of the KZNIBE would also have a multi-disciplinary approach to teaching design.

- **The Building was Designed Specifically for the School**

Because the Pretoria School for the Built Environment occupies a building that was designed specifically for the school, it was far more beneficial to analyse its planning,

rather than the planning of a school housed in an existing building which compromises the schools specific needs and space requirements.

- **The Original Building had to be Significantly Amended**

The building itself has an interesting history, as it was drastically altered just 12 years after construction, partly due to serious faults in the original design. It is important to consider these faults in order to avoid repeating them in the design of a KZNIBE.

- **The Building was Intended to Accommodate Meetings of the Local Built Environment Community**

It is interesting that the school was always intended to be a place of congregation and interaction between students, staff and practitioners involved in Architecture and Quantity Surveying.

It would be one of the primary roles of the KZNIBE to facilitate such interactions between the various disciplines and groups involved and interested in the Built Environment.

5.1.2. Introduction

Besides its interest as a multi-disciplinary school of design in the built environment, the 'Boukude' building itself was an especially fascinating building to study.

The school aims to achieve a ratio between its three disciplines of 50% architecture, and 25% each for interior design and landscape architecture. The ratio of the staff reflects this objective. There are 14 permanent staff positions, 8 of which are dedicated to architecture, and 3 each to other two disciplines.

In reality however, the actual ratio between students in the three disciplines falls short of the schools target. Of the total 450 students, architecture considerably dominates in popularity, and comprises 350 students. Interior design is the next popular choice, with 70 students, whilst landscape architecture has only 30.

In the first year of study, there is no distinction in the curriculum between students in the various disciplines. Thus, a student who begins their under-grad degree in one discipline may after their first year opt to change to another, provided their results are

satisfactory. This dynamic further adds to the disproportionate number of students who choose to study architecture.

5.1.3. The History of the 'Boukunde' Building

The building for Pretoria School for the Built Environment (Boukunde) was originally constructed in the 1961, yet only the structural core of the original building remains. The original design was a miesian exercise. It displayed the modern architectural ideals of the period, and demonstrated the new building technology that had initiated the movement. The building was a two storey reinforced concrete column and floor plate structure, with the columns set back from facades of aluminium and glass curtain walls. (Fig 5.1.1)



Fig 5.1.1. The original 1961 structure viewed from the North-West. Note the extensive unshaded glazing on the North façade and the blinds closed behind the glass. (SA Arch Record, June 1961, p10)

To encourage interactions between students, the basic concept of the original planning was to centralise the activities of the building. For this reason, and in order to allow natural lighting, an atrium was placed in the centre and movement of students and staff took place around it. The atrium's glass walls allowed visibility from the ground and first floor, and to other areas of the building. (Fig 5.1.2)

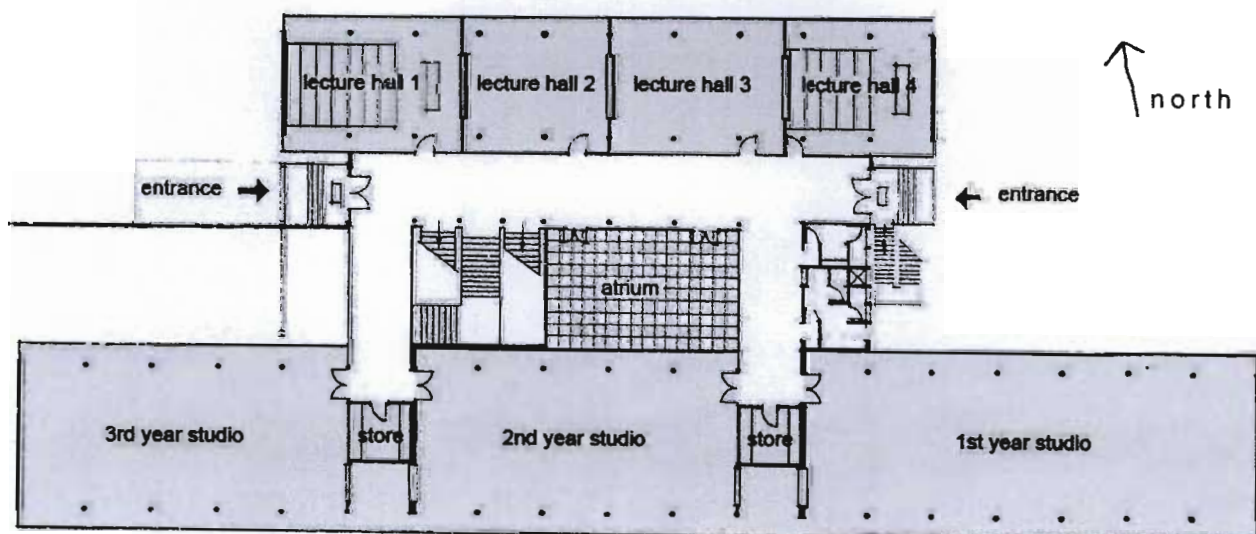

Fig 5.1.2. The main stairs, placed adjacent to the central atrium. The unusual design of the stairs is borrowed from the Bauhaus' main stair, reinforcing the design's clear allegiance to modernism. (SA Arch Record, June 1961, p12)

There was however not enough money to build display and critique rooms, and so the entrance foyer and passage on the first floor were made especially wide (Fig 5.1.2), and furnished with display screens and wall coverings on which work could be presented. This idea was thought to work well because everyone in the school would constantly pass by the displays and see the work from different years.

A main lecture hall seating 120 was placed on the ground floor near the entrance so that it could be most easily accessible to the public. The idea was that the lecture hall would become a central meeting point of assembly for the architectural and quantity surveying community in Pretoria.

Fig 5.1.3 Original Ground Floor Plan. 2 Simple wings: Lecture halls on the North and studios on the South. (SA Arch Record, June 1961, p10)



The university even allowed for a small tea kitchen, with a service hatch across the entrance to the lecture hall, to cater for such gatherings.

"Well attended lectures have been held in the lecture hall, with the promise of attracting more practicing professionals to the building." (A.L. Meiring: SA Architectural Record, June 1961, p10)

Whilst the structure was pioneering, one of the first of its kind in South Africa, the harsh consequences of importing the 'International Style' to the Highveld soon became too apparent and unforgiving to ignore.

The spaces inside the building were exceptionally uncomfortable. Sun control was attempted by installing internal blinds, and although these may have solved the problem of glare, the un-shaded over glazed envelope still allowed far too much solar gain, and offered no thermal insulation.

Furthermore, the vast glazing provided little resistance to the traffic noise from the busy road against the southern boundary, which especially affected the studios. Other problems included a leaking roof, poor ventilation in the bigger rooms, no auditorium to accommodate the entire school, and no workshop.



Fig 5.1.4. *The studios on the South side of the building: Noise from Lynnwood Way, just below the windows, was a problem. (SA Arch Record, June 1961, p10)*

Fortunately by 1973 student numbers had increased by approximately 100, and alterations had to be made. This created the opportunity to not only extend the existing building, but also to amend its flaws. Dannie de Beer was appointed as the architect.

The alterations consisted of two new lecture halls, critique areas, a library, and a new floor for more studios and staff offices. A concrete skin was built around the entire building and the atrium was roofed. The alterations increased the building's thermal capacity, shaded the north facades and reduced noise penetration. To further counter traffic noise, the wall on the southern edge was made almost entirely solid, with only a few very narrow double glazed windows placed in the façade. (Fig 5.1.5 and 5.1.11)

Fig 5.1.5 One of the few narrow double glazed windows in the studios on the Southern edge of the building.

(Source: Author)



The re-design of the northern façade, which faces the University campus, was determined by the dire need for sun control, and consists of long balconies set in front of the large windows which they shade.

5.1.4. An Evaluation of the Building Today

It is now 34 years since the 1973 alterations. The building was repainted in 2001, and is in great condition. The extraordinary creative paint scheme is an indication of the nature and function of the building, and reinforces its distinctly 70's character. (Fig 5.1.6)



Fig 5.1.6. The back of the main lecture hall projects out on the northern facade. Note the retro paint scheme. (Source: author)

Fig 5.1.7 Siteplan. (Source: author)

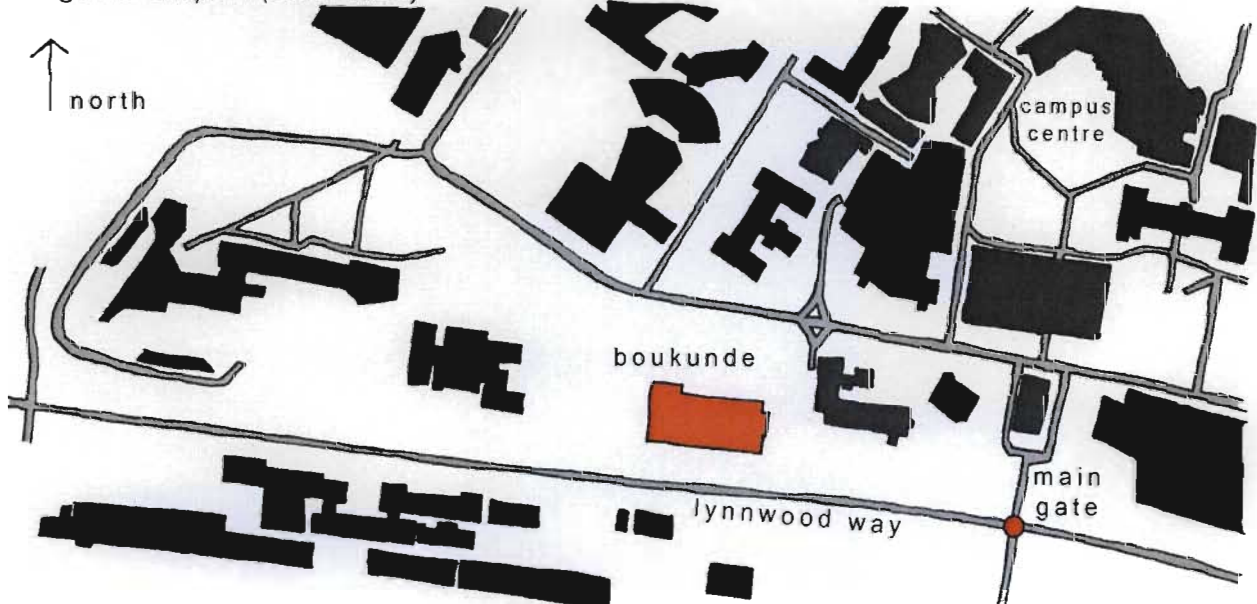

- **Site and orientation**

The 'Boukunde' building is situated in the South-West quadrant of the University campus, just 150m from the main entrance off Lynnwood Road. This close proximity to access from Lynnwood Road would have been especially advantageous back when the building accommodated meetings of the local architectural and quantity surveying community. However, Professor Fisher (a senior member of the faculty) agrees that because the building sits on the perimeter, it relates poorly to the rest of the campus.

(Fig 5.1.7)

The building is angled well in terms of solar orientation, creating the opportunity to exploit almost precisely north and south elevations. In addition, the building's long rectangular form maximises the north and south facades.

Unfortunately, the opportunity of large south facing windows in the studios was lost due to the problem of traffic noise from Lynnwood Way. In addition, the studios also lost their north facing facade in the 70's alteration. (Fig 5.1.18 – 5.1.19) The disappointing result is that only the staff offices and staff room, the library (and oddly a computer room,) take advantage of the good orientation. (Fig 5.1.8)



Fig 5.1.8 *The library. Note the extensive louvered glazing on the northern facade - providing quality natural light and ventilation. (Source: author)*

- **Planning**

The planning is still organised in the original two parallel wings, although now far more difficult to make out in solid mass of the present structure. (Fig 5.1.18 – 5.1.20) The atrium, now roofed and open to the corridors, is a triple volume that connects the buildings various activities. The southern wing contains the students' studios. The northern wing accommodates the staff room and offices, a small library, a computer room, and an exhibition room near the entrance. A double volume critique room is positioned on the eastern end, whilst two raked lecture halls terminate the western end.

The arrangement of the two large lecture halls and an exhibition room on the western end,

closest to the entrance, demonstrates sensible planning. These are the least private spaces in the school, and require a certain degree public access. Furthermore, rather than returning to their studios, students use the generous platform just outside the entrance as a place of congregation between lectures. (Fig 5.1.9)



Fig 5.1.9 *The entrance platform – students gathering between lectures. (Source: author)*

This behaviour may be somewhat due the students' inherent desire to connect with the rest of their campus; consequently, it gives a pleasant liveliness to the schools front façade.

The studios are also sensibly positioned, and are located in the southern wing across the atrium. Consequently, they are accessed farthest from the entrance. These planning

decisions have set up a privacy gradient, or hierarchy of space, which provides the studios with a greater measure of security and privacy than other areas in the building.



Fig 5.1.10 *The wide corridors split by pin-up boards are still used as crit spaces – students gathering between lectures. (Source: author)*

Even though special critique rooms were built during the 70's alterations, the wide corridors with pin-up screens still remain, and the covered atrium creates even more exhibition space on the ground floor. As Professor Fisher explains, 'the building has become a 'crit' space... all the walls have pin-up boards'.

(Fig 5.1.10)

- **Environmental Response**

It's clearly evident that environmental considerations were significant design influences. The original 1960's design deliberately created two well orientated wings, designed narrow to encourage cross-ventilation and natural lighting. In addition, the short east and west facades were made solid to avoid direct sun penetration. (Fig's 5.1.1 and 5.1.3)

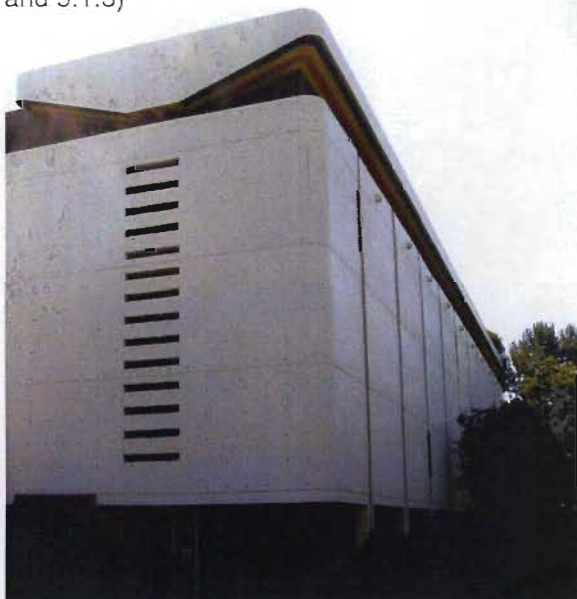

Fig 5.1.11 View from south-west corner. Note the almost solid southern facade shielding the studios from traffic noise. (Source: author)

Unfortunately, after the 1973 alterations, the opportunity to cross-ventilate was lost as the two distinctive wings were swallowed up in the singular mass of the new scheme. (Fig 5.1.18 – 5.1.20) In addition, the absence of almost any windows on the south façade, (Fig 5.1.11) meant the studios needed to be artificially lit and ventilated.

The new studios on the second (top) floor are an exception in that they are naturally lit by north and south facing clerestories that run the entire length of the studios. (Fig 5.1.12) Even though the studios are air-conditioned, they are excessively warm in the summer months.



Fig 5.1.12 The 1st year studios on the 2nd floor. Note the north and south facing clerestories. (Source: author)

On the other hand, the north facing offices, staff room and library, are still naturally lit and ventilated. These are undoubtedly the most pleasant spaces in the building.

The large windows on the north façade are protected from direct sun-light by balconies with solid concrete balustrade walls and light suspended screens (Fig 5.1.14), and therefore provide the interiors with a good quality of indirect light. Although not cross-ventilated, the windows are louvered to maximise air circulation. (Fig 5.1.8)

The central volume is naturally lit by a row of very interesting skylights, constructed from standard glass blocks cast horizontally into the concrete roof slab. (Fig 5.1.13)



Fig 5.1.13 Skylights above the central volume – glass blocks cast in random patterns into the concrete roof slab. (Source: author)



Fig 5.1.14 The 1st year studios on the 2nd floor. Note the north and south facing clerestories. (Source: author)

5.1.5. Conclusions from a discussion with Prof Roger Fisher

I asked Prof. R Fisher what he would change in the building if he had the opportunity, his response was that:

- Firstly, he said he would appreciate a better split between public and private areas. Although a sensible privacy gradient has been created, I agree that the offices and studios, especially on the ground floor, may lack privacy and security.
- Secondly, he would provide better disabled access. As there is no lift or ramps to the upper floors, it is impossible for disabled persons to access most of the building. This is obviously unacceptable.
- Thirdly, he would create a place for students to 'mess'... to experiment with building techniques, like laying bricks for example. I agree that if students have a better understanding of how to put buildings together, then they are able to design and experiment with far more confidence.

With the design of an Institute for the Built Environment in mind, I asked Prof. Fisher what he felt were essential elements in a School for the Built Environment:

- Good public access, whilst still maintaining security and private areas.
- One large studio for all years to share
- Cubic offices in the studios for the dedicated studio staff
- One large open plan office for all the staff (on a separate level to students)
- A planning program that facilitates discourse
- A student/staff meeting room
- The school should not hide its 'guts' (its structure and services); it should demonstrate best practice.

To conclude our discussion, I questioned the future trend for schools of the built environment in South Africa. Professor Fisher predicts a far greater synergy to develop between the various institutions, with each school been recognised for their distinctive strengths. As a result, schools would improve even further in their particular strengths.

The drawback of this may be that students in a particular school, for example a school recognised specifically for its conceptual strength, would not adequately develop their technical skills. Although I agree with the professor, and this trend has already been evident for some time, I believe any school should still offer a reasonably well rounded education.



Fig 5.1.15 The central volume. The triple volume connects the buildings activities. The broad sculptural stairs are a gathering space for students and the spot for an annual 'stair party'. (Source: author)

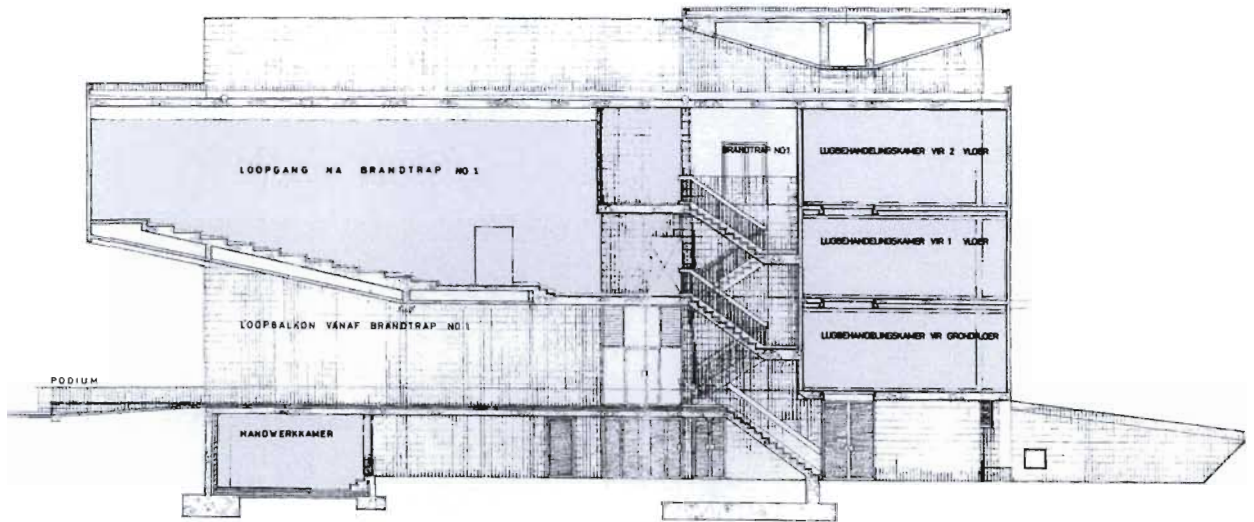

Fig 5.1.16 Cross Section

(Plans and Section sourced from the 'Boukunde' library archives.)

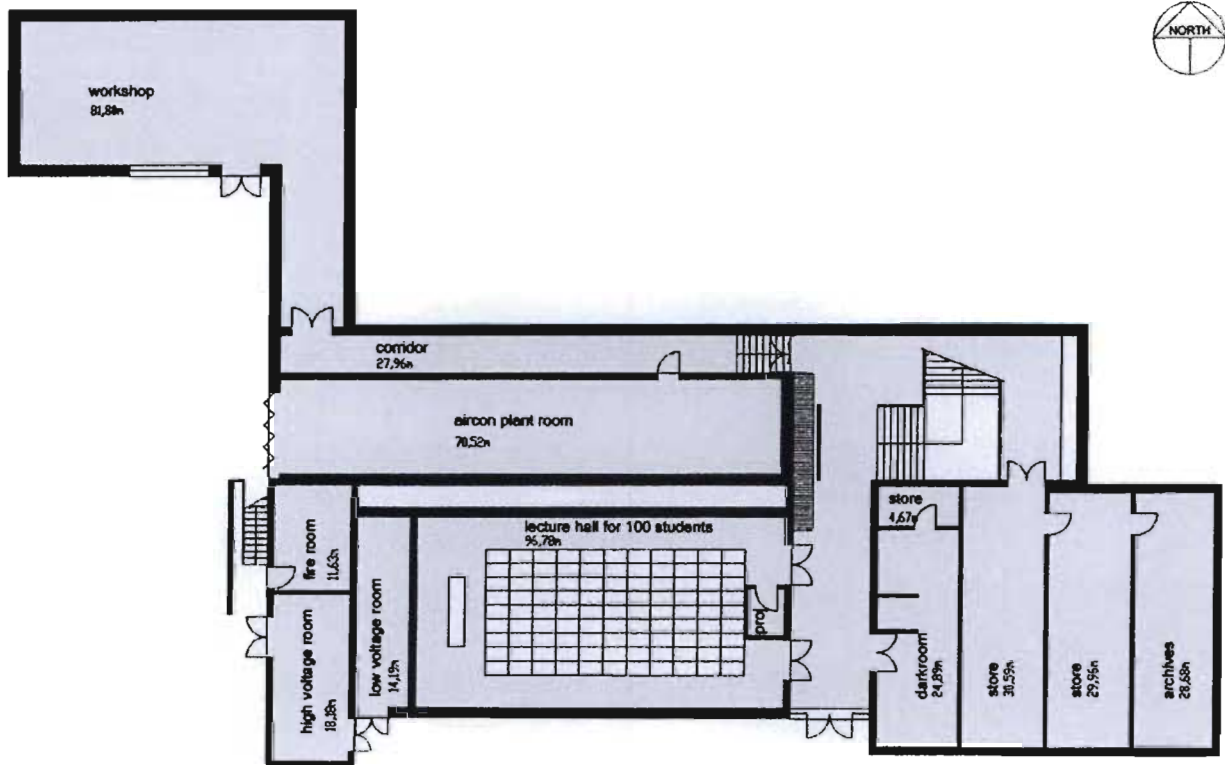

Fig 5.1.17 Lower Ground Floor Plan

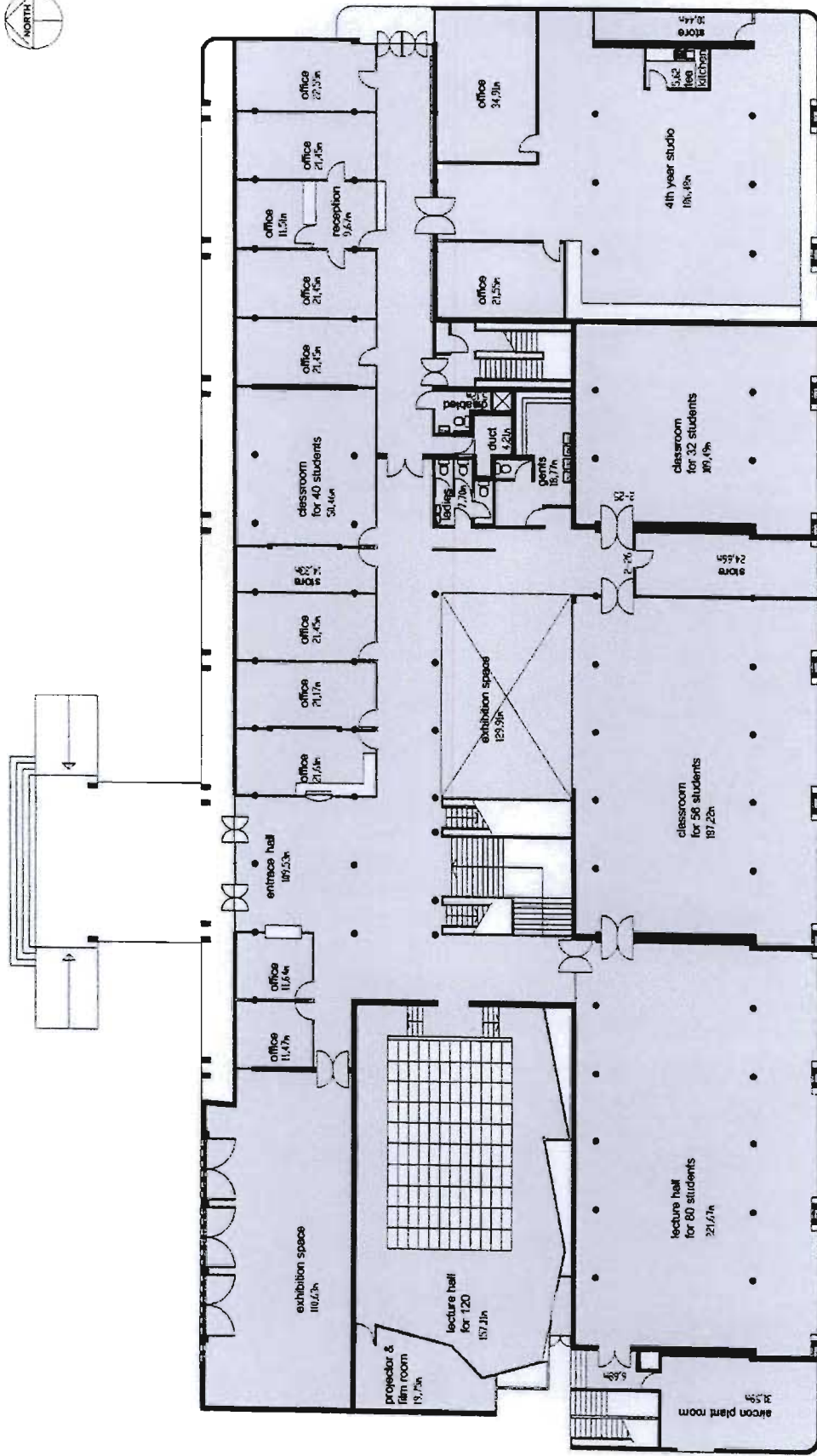

Fig 5.1.18 Ground Floor Plan

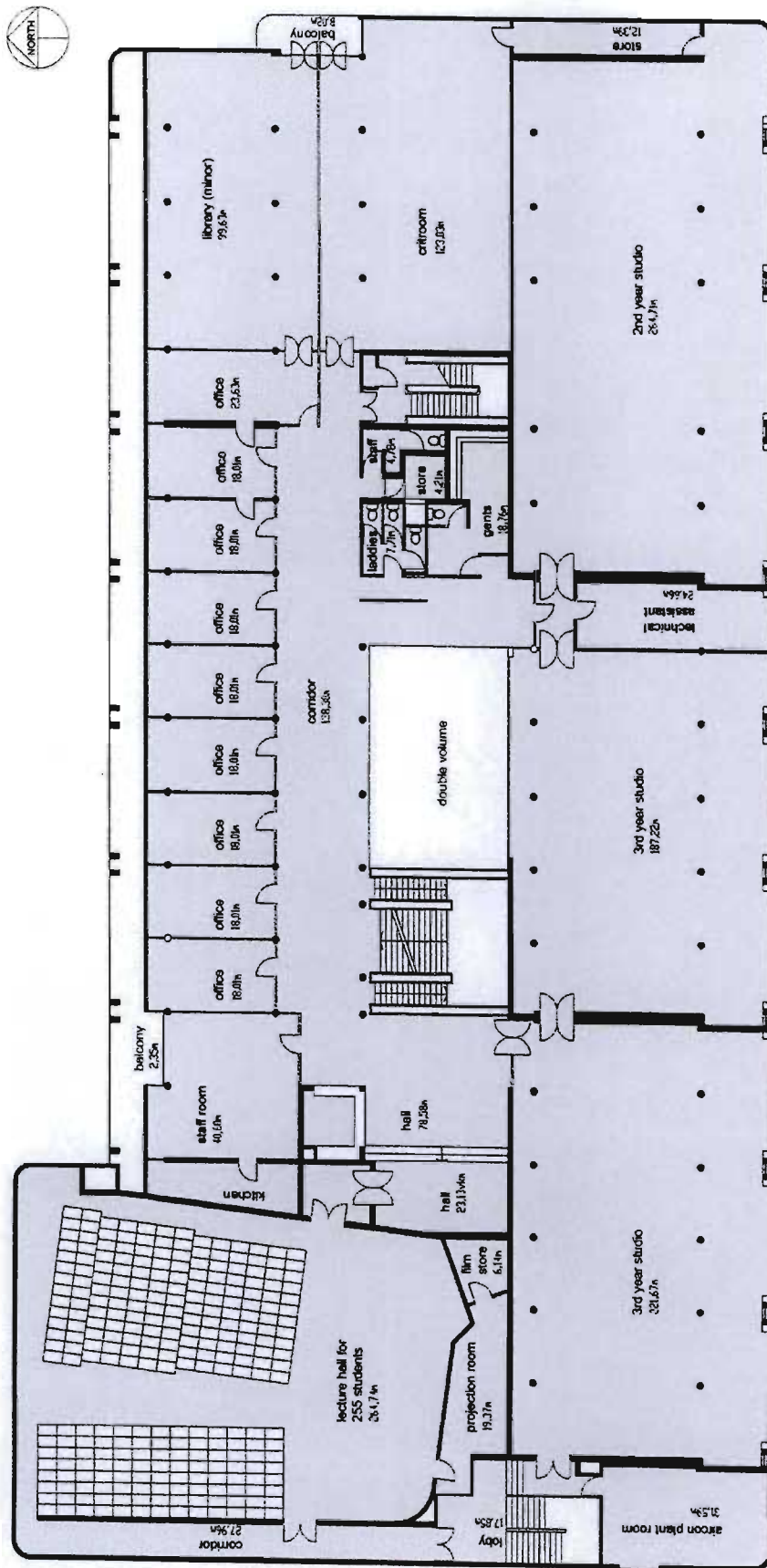

Fig 5.1.19 First Floor Plan

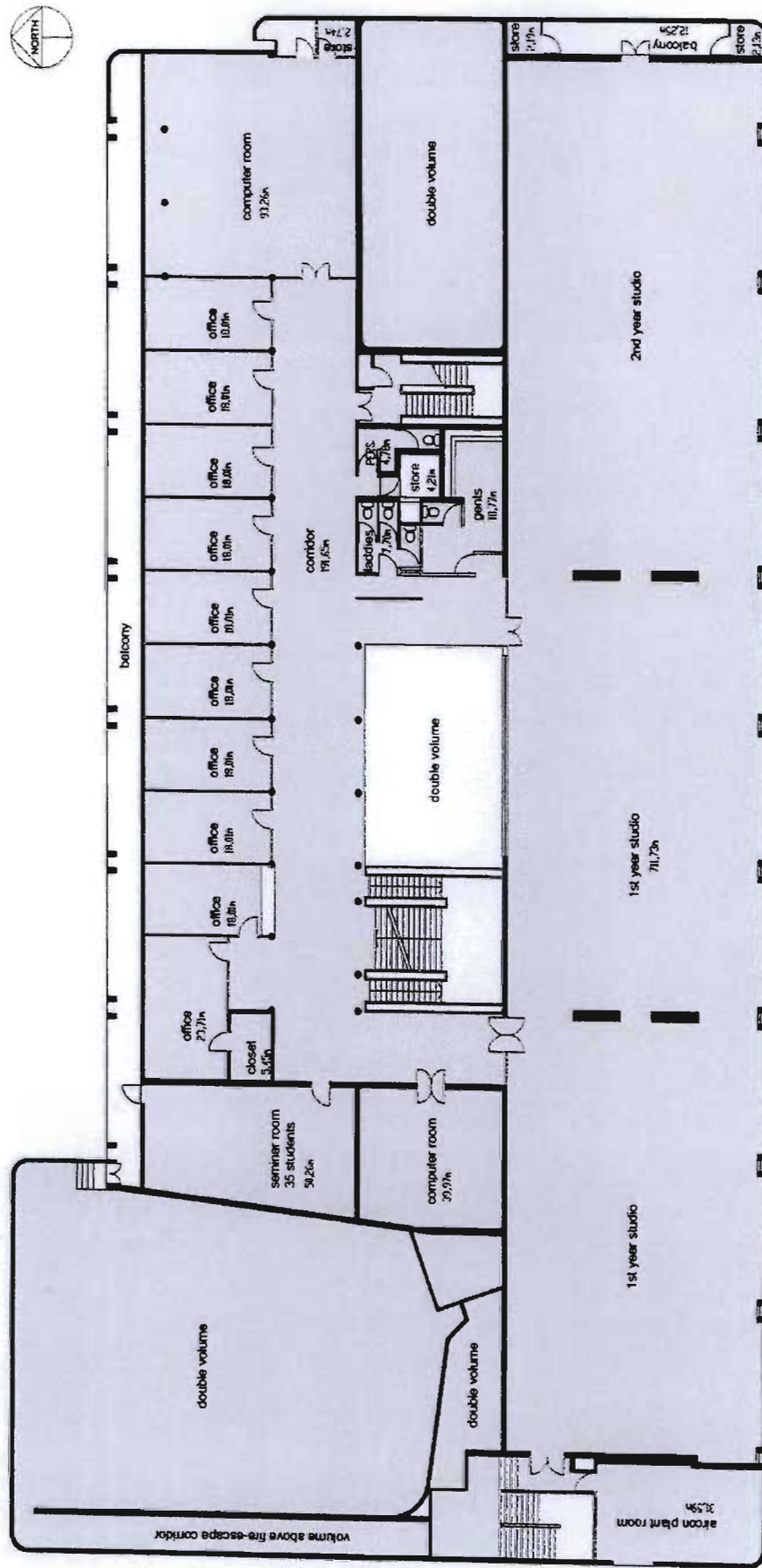

Fig 5.1.20 Second Floor Plan

5.2. Case Study 2 – The KwaZulu-Natal Institute for Architecture

5.2.1. Reasons for Choosing the Case Study

- **The KZNIA was key in the conception of a KZNIBE**

The KZNIA was founded over a hundred years ago and has since been Durban's sole organiser of events dealing with the built environment. The institute has thus paved the way for the conception of a KZNIBE.

The current boom in the building industry and the subsequent construction of a number of exceptional developments in the province has led to a boosted popularity and interest in events organised by the institute. This factor, combined with their lack of suitable facilities at 106 Bulwer Road, has created a problem, but also an opportunity to extend their operation further, and draw the public in.

- **The administration of KZNIA would be accommodated in the KZNIBE building**

The KZNIBE building would become the new home of the KZNIA, where it would continue to carry out its current functions.

As well as accommodating the administration of the KZNIA, the new KZNIBE building would take over the responsibility of hosting events organised by the KZNIA and other organisations involved in the built environment. The Institute would therefore not need to depend outside facilities.

For these reasons an examination of the Institute's functions and current facilities is essential in order to accurately design their new accommodation.

5.2.2. Introduction

The KZNIA is a regional institute which falls under the South African Institute of Architects. The institute is a voluntary association which "aims to promote excellence in architecture and it seeks to contribute to the enhancement of society and the environment."

(SAIA practice manual, 1999)

Fortunately, a prerequisite for architects who wish to be registered with SAIA is that they are members of their respective regional institute. Thus the membership of the KZNIA is maintained fairly high.

5.2.3. A Brief History of the KZNIA

The KZNIA dates its founding from the 1st of September 1901, when a group of 15 architects gathered to form an architectural association to represent the colony of Natal. At that meeting the association was formed, and named the 'Natal Institute of Architects'.

Since then the institute has had to adapt to various amendments to state policy and take on new responsibilities. As a result the institute has had to alter its name a few times to suit the changing circumstances.

1901 – 27 <i>Natal Institute of Architects</i>
1927 – 91 <i>Natal Provincial Institute of Architects</i>
1991 – 95 <i>Natal Institute of Architects</i>
1996 – <i>KwaZulu-Natal Institute for Architecture</i>

(KZ-NIA Journal 1/2001, pg 3)

The Institute has also changed its address numerous times. Since its founding it moved around between various office buildings in the CBD.

Then in 1989 the NPIA (as it was named then) began to provide secretarial services for the Durban Heritage Trust, which was a new City Council committee with the means to own premises.

This collaboration with the DHT led to the joint purchase of a derelict Edwardian house that was on a piece of land at the edge of Bulwer Park in Glenwood, which the council had previously claimed. Restoration of the house followed, and the KZNIA's current home at 160 Bulwer Road was officially opened by the Mayor of Durban on the 28th of June 1993. The building received a city conservation award later that same year.



Fig 5.2.1 The home of the KZNIA at 160 Bulwer Road. (Source: author)

5.2.4. The Functions of the Institute

The KZNIA is responsible for supporting its members' best interests and upholding the standard of the profession in the province.

The Institute performs an outstanding job of organising lectures, exhibits and awards ceremonies, held at both its own venue in Bulwer Road as well as other larger venues.

The KZNIA produces its own magazine, with a new issue published every two months. Amongst other things, the magazine deals with current issues in KZN surrounding the built environment, and gives deserving exposure to worthy developments in the province.

The institute is also responsible for recognising exceptional architecture by awarding regional merit awards to deserving new buildings in the region.

5.2.5. An Analysis of Site and Building

Brian Kearney dates the construction of the Edwardian House to the year 1900 and describes it like this:

"A single storied house of Victorian Period with later Union Period front veranda in Vernacular style. Main pyramidal roof and articulated veranda roof. Notable columns, quoining, encaustic tiles and front garden walls."

(Kearney, 1984)

When the KZNIA first moved into the property at 160 Bulwer Road, it was rather isolated at the edge of the park. Fortunately, it soon received a new neighbour, when in 1996 the Natal Society of Arts constructed its own gallery on the adjacent site. The move held great significance and began establishing a cultural precinct in Glenwood.

The design for the gallery was selected from a competition, entered by some of Durban's best architects. As a result, the gallery responds well to the Institute's building, and an exciting space, used as the gallery's tea garden, was created between the two. *The space between the two buildings is now an important social and cultural node on Durban's Berea.* (Peters, KZNIA Journal 1/2001:p3)



Fig 5.2.2 *The exceptionally pleasant tea garden, created in the space between the gallery and 106 Bulwer Rd. (Source: author)*

The interior of the Edwardian house has been considerably altered to create a larger space for gatherings (Fig 5.2.3 & Fig 5.2.5). Adjacent to this central space is a large boardroom, separated by sliding-folding doors that when opened, increase the size of the space significantly. (Fig 5.2.4)

A small kitchen has been created which connects, via two serving counters, to both the

boardroom and the central space. The kitchen is used to prepare tea for meetings in the boardroom, as well as cater for larger events, when the serving counter acts as the bar.

The three other rooms in the 'house' are occupied by the two secretaries' offices and a store room. Separate toilet facilities are provided for males, females and paraplegics. (Fig 5.2.5)



Fig 5.2.3 The central space at 106 Bulwer Rd which is designated for events (Source: author)

The out-building on the property consists of two offices, one occupied by the Natal Heritage Society, and the other used by the adjacent NSA gallery.

5.2.6. Conclusions

Although significantly altered inside to create a larger space for gatherings (Fig 5.2.5), regrettably 106 Bulwer Road is no longer adequate premises for the KZNIA.

The main concern is that the space designated for small exhibits and presentations is still unacceptably tight, and seriously compromises the success of well attended events.

In addition, the Institute now has the responsibility of hosting CBD activities, which consist of workshops, presentations and formal lectures.



Fig 5.2.4 The boardroom opens up to the central space with sliding folding doors

(Source: author)

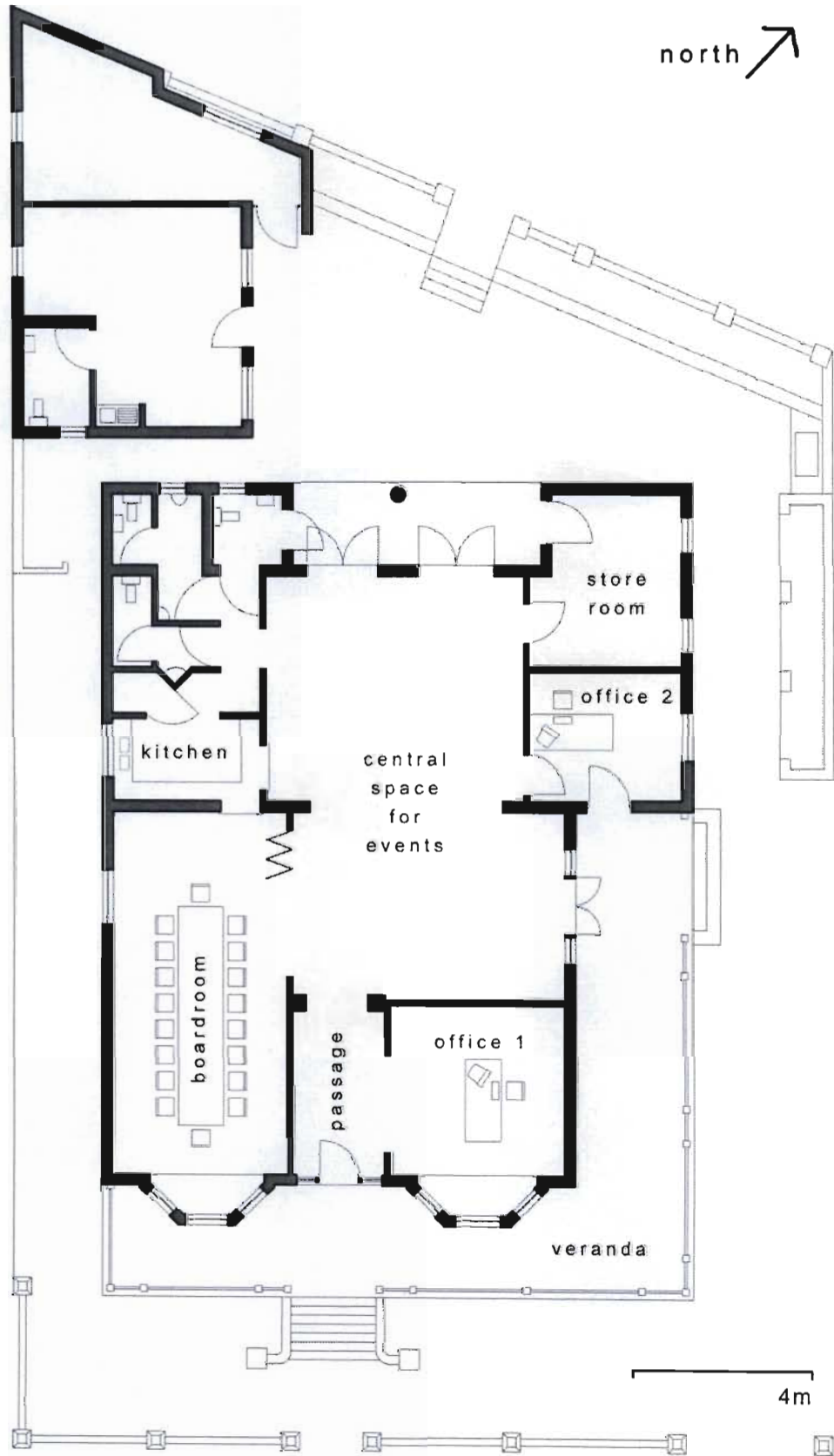

Fig 5.2.5 Plan of 106 Bulwer Road.
(Drawn from plans provided by Bruce Clark)

Chapter 6

6.1. Design Requirements

Following a consideration of the precedents and case studies in previous chapters the following have been concluded to be the most appropriate primary components of a KZNIA.

1. Exhibition space
2. Auditorium
3. Catering facility
4. Library
5. Administration
6. Studio (for school of design)
7. Lecture, seminar and CAD teaching rooms

6.1.1. Exhibition Space

- **Description**

The exhibition space would certainly be the most public component of the KZNIBE. It therefore seems appropriate for this space to become the central heart of the institute, both in a physical planning sense, and in terms of the energy it could generate in the building.

In order to maintain a privacy gradient the exhibition space would also need to be placed with the other public components close to the main entrance.

In terms of size, the exhibition space should comfortably accommodate a gathering of at least 200 people.

- **Design**

It is not advisable to design an exhibition space too specifically for the intended displays. Gemma Hunter explains that *'almost the only thing they (exhibition spaces) have in common is that all objects on display were never designed to be there.'* (New Metric Handbook, 1979)

As one could never predict all the ways a space could be used for an exhibition, it is more desirable to create an exciting yet flexible volume that presents an infinite number of possibilities... a blank canvas.

Neufert on the other hand presents scientific methods of exhibiting displays within a comfortable field of vision.

'The normal human angle of vision starts 27° up from eye level... The best hanging position for smaller pictures is with the point of emphasis (the level of the horizon in the picture) at eye level.' (Fig. 6.1.1)

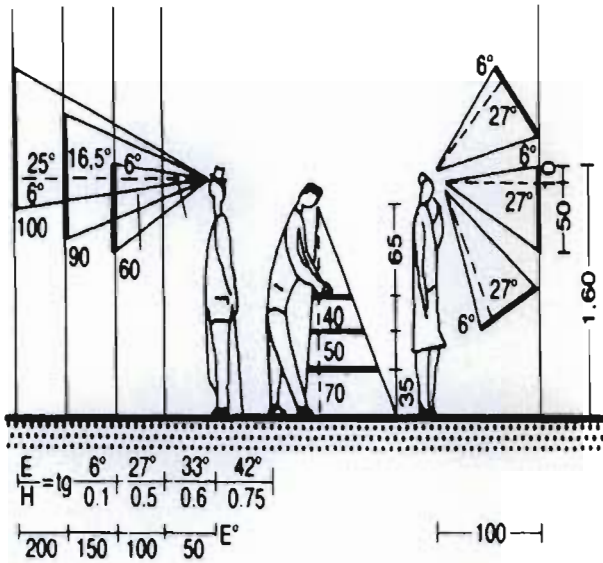

Field of vision: height/size and distance

Fig 6.1.1 (Neufert, 2000:333)

- **Exhibition prop store room**

This room would be used for the storage of display screens, plinths, tables and any other exhibition props. The store room should be directly linked to the exhibition space to make moving equipment as simple as possible.

- **Workshop**

The workshop would be used to assemble exhibition props, and therefore should also be placed relatively close to the prop store room and exhibition space.

The workshop would however also be used by students on their own projects, and it therefore needs to be significantly isolated from the exhibition space.

- **Lighting**

Although the exhibition space would be naturally lit as far as is possible during daylight hours, the provision of a well considered artificial lighting strategy would be essential.

Le Corbusier's design for the National Museum of Western Art in Tokyo employs innovative sky-lights which diffuse direct sunlight in order to generate a soft quality of natural light into deeply recessed spaces. (Fig 6.1.2)

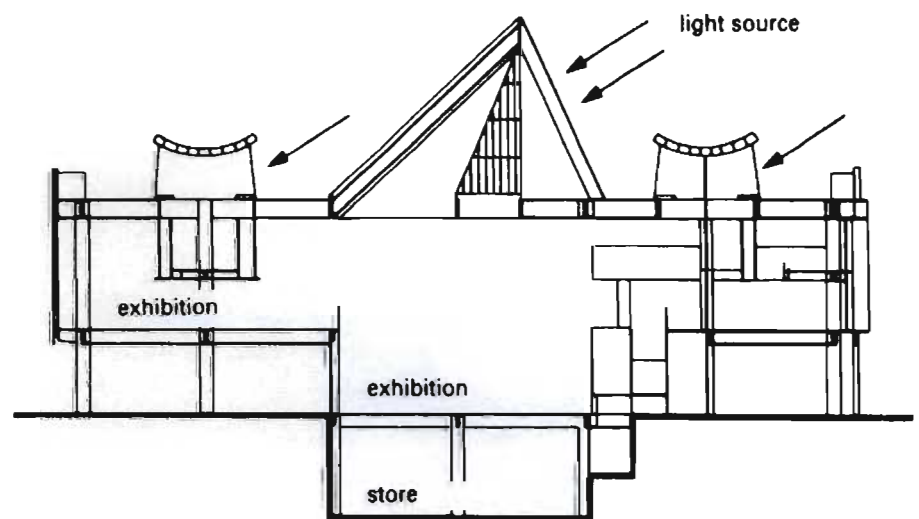

Fig. 6.1.2. Section through Le Corbusier's National Museum of Western Art in Tokyo.

(Neufert, 2000:333)

Since events at the KZNIBE would almost always take place in the evenings, the quality of the lighting design, particularly in the exhibition space, is especially important.

The choice of lighting should however be energy efficient, and would preferably run off batteries charged by solar panels.

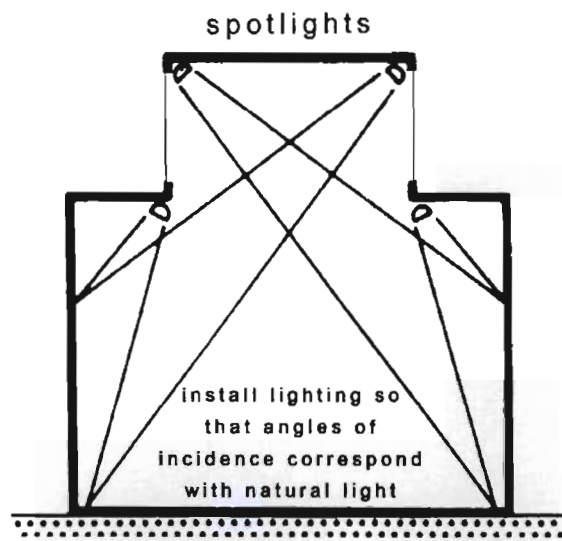

Fig 6.1.3 (Neufert, 2000:333)

The types of lamps that could be used to light an exhibition space are listed in Fig 6.1.4 and illustrated in Fig 6.1.5.

Various ways of using lighting in an exhibition space are represented in Fig 6.1.6.

Lighting provision for an Exhibition Space with a room height over 5m	
nominal illuminance: up to 750 lux	<ul style="list-style-type: none"> - HME > 80 W - HIT-DE > 70 W - HIT > 70W - HIE

Fig 6.1.4 (Drawn from Neufert, 2000:143)

high-pressure discharge lamps



- HME  P(W): 50–400 mercury vapour lamp
- HIT-DE  P(W): 70–250 halogen metal vapour lamp
- HIT  P(W): 35–150 halogen metal vapour lamp
- HIE  P(W): 75–400 halogen metal vapour lamp elliptical

Fig 6.1.5 (Drawn from Neufert, 2000:141)

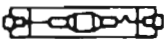
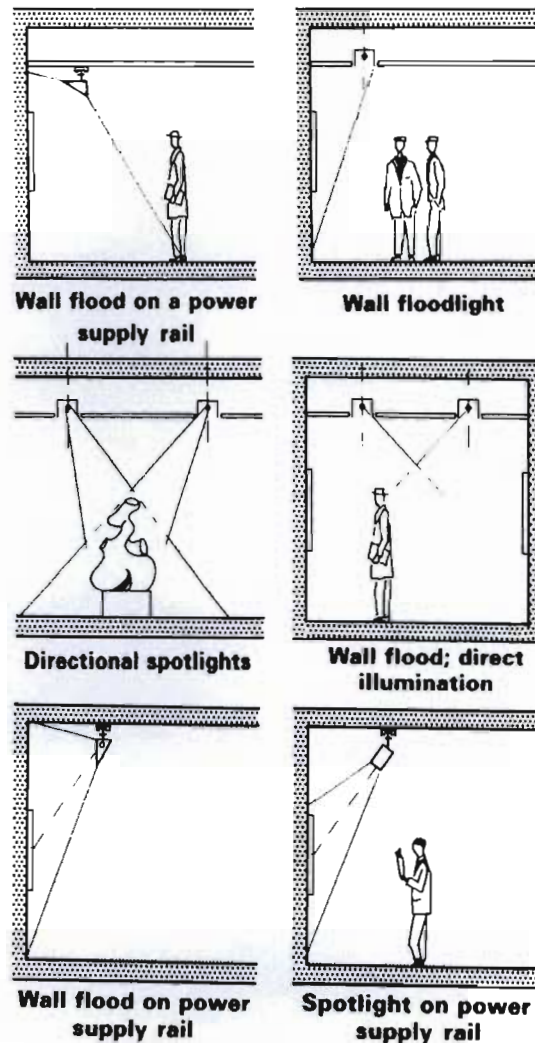

Fig 6.1.6 Various methods of lighting an exhibition space (Neufert, 2000:144)

6.1.2. Auditorium

- **Description**

The auditorium would accommodate larger CPD presentations and ceremonies attended by professionals involved in the built environment, interested members of the public and the students and staff of the Institute's school of design.

The KZNIA's 2007 'Corobrik' awards ceremony held at the KZNSA attracted almost 100 professionals. This particular function largely excluded students and interested members of the public. (Fig 6.1.7)



Fig 6.1.7 Awards ceremony at KZNSA

(Source: author)

An auditorium for the KZNIA should therefore accommodate a considerably larger audience, and between 150 and 200 seats seems appropriate.

As the auditorium is one the most public components of the KZNIBE it should be positioned in the public domain, reasonably near to the entrance.

- **Seating**

Comfortable raked cinema-type seating offering unobstructed lines of sight would most favourable. Seating should be arranged for ease of movement to and from ones seat, as well as for efficient exit from the auditorium.

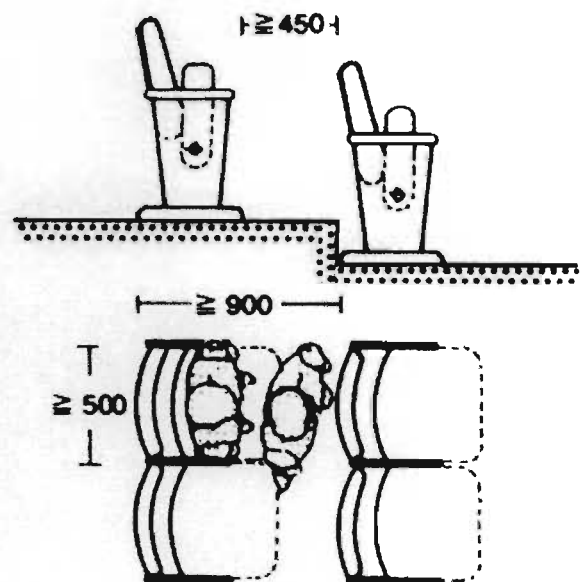

Fig 6.1.8 The minimum spaces required between seating in an auditorium

(Neufert, 2000:481)

- **Large screen for the presentation of slideshows and films**

The seating should therefore have a cinema-type seating arrangement rather than a theatre-type. This requires all seating to be angled almost perpendicular to a screen in the front the auditorium, rather than wrapping around a stage or podium.

- **Rear projection room**

Rear projection simply means that instead of projecting an image onto a screen from the back of an auditorium, a reflected image is projected from inside a room behind the screen. (Fig 9.1.9)

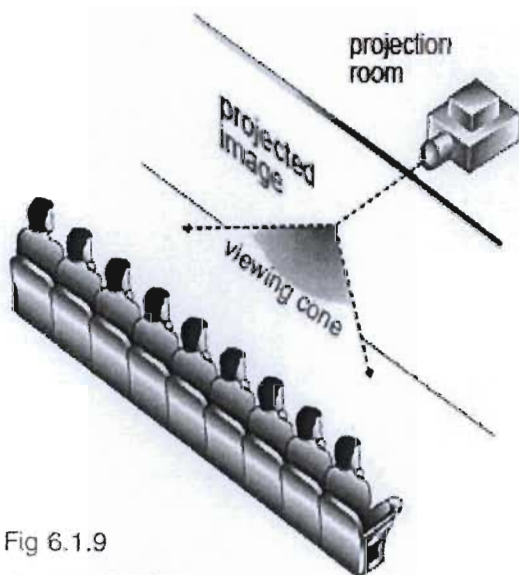

Fig 6.1.9
Rear projection room
(Rosco)

Advanced rear projection allows for a space to be fairly lit during presentations, thus allowing an audience to read and take notes.

Another advantage of is that a speaker is able to stand in front of the screen during presentations, without casting a shadow.

- **Sound desk**

It is favourable to adjust the sound volume, lighting and screen display during a presentation from the back of the auditorium without interrupting the presentation.

- **Ventilation**

Due to the closed nature of an auditorium (for lighting and acoustic control) natural winds cannot be easily exploited to naturally ventilate the space.

Although a conventional air-conditioning system would be avoided, a low-energy mechanical system will certainly be required to force air movement and achieve the required ventilation.

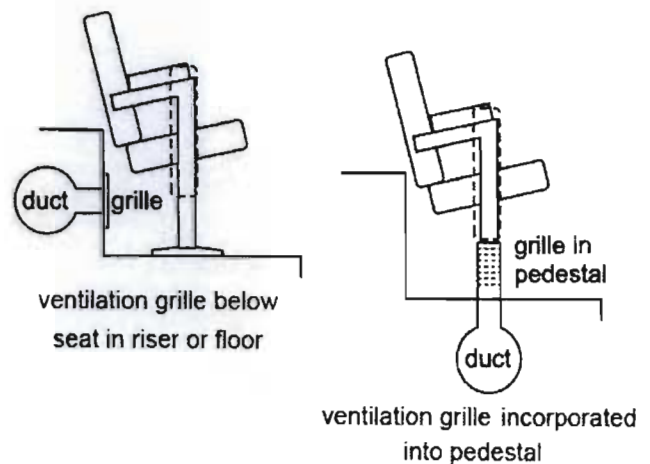

Fig 6.1.10 Two possible positions for the ventilation ducts and outlets.
(Adler, 2000:20.3)

- **Lighting**

The auditorium would depend completely on artificial lighting. Neufert provides data on the illumination requirements and three correct types of bulbs appropriate for an auditorium with a volume exceeding 5 meters in height.

(Fig 6.1.11)

Lighting provision for an auditorium with a room height over 5m	
nominal illuminance: up to 200 lux	- general purpose lamps >100 W - parabolic reflector lamps 56 - halogen filament lamps ≤250 W

Fig 6.1.11 Drawn from (Neufert, 2000:143)

Although the two filament lamps specified in Fig 6.1.11 and illustrated below in Fig 6.1.12 would produce the required illumination, as shown in Fig 6.1.13, halogen bulbs last much longer and use far less energy.

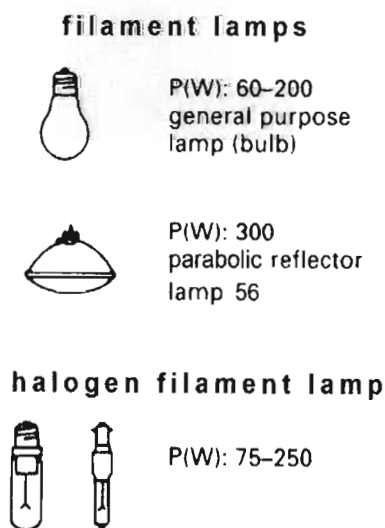
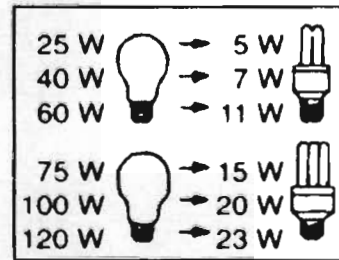

Fig 6.1.12 (Drawn from Neufert, 2000:141)

**standard filament
vs
halogen filament**



halogen filament: up to 80% saving in electricity and life expectancy 10 times longer

Fig 6.1.13 (Drawn from Neufert, 2000:141)

- **Acoustics**

Sound should reach each member of the audience with equal amplitude and without any echo. Suspended ceilings can be manipulated reflect or absorb sound. Rear walls should be lined with sound absorbent material, whilst other walls should be smooth.

6.1.3. Catering Facilities

- **Description**

This component would cater for visitors attending various events at the KZNIBE, and should be large enough to cater for at least 200 guests.

These facilities should be directly linked to the auditorium and exhibition space as part of the public domain within the KZNIBE.

- **Snack-Bar**

The core of this component would be a snack-bar suitable for preparing and serving drinks and cocktail snacks during events.

A typical section through a snack-bar, with cold storage under and behind the serving counter, is illustrated in Fig 6.1.14.

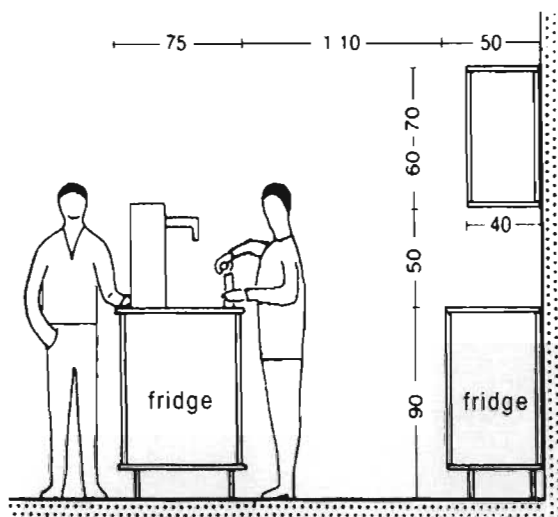

Fig 6.1.14 Section through snack-bar serving counter (Neufert, 2000:455)

- **Storage**

The storage of refrigerated drinks and food stuff is another necessary consideration. Much of the storage would take place under the counters as shown in Fig 6.1.14.

A separate cold storeroom may however be necessary to store a greater stock. This cold room would obviously be best located as close as possible to the bar/kitchenette for straightforward restocking.

- **Furniture**

Although some café-type chairs and tables would be provided, it would not be necessary to provide seating for everyone attending larger events.

6.1.4. Library

- **Description**

The library would not only serve students and staff at the KZNIBE, but also be available for professionals involved in the built environment. It therefore needs to be positioned with a reasonable level of public accessibility in mind.

Although the library would include the typical books on urban design, landscaping and architectural design, its major focus would be to specialise in industry publications and product specifications.

- **Issue Desk**

An issue desk is ideally placed at the entrance of a library. This is done not only to improve security, but it also positions the staff perfectly to offer assistance to anyone that enters.

The library should also be laid out in such a way that offers the staff reasonably good surveillance from the issue desk.

- **Book Stacks**

After examining the precedents, findings indicate that a library housing 8000 volumes and therefore having a book stack floor area of approximately 120m² would be appropriate to serve the KZNIB's requirements.

The minimum dimensions between shelves are demonstrated below in Fig 6.1.15.

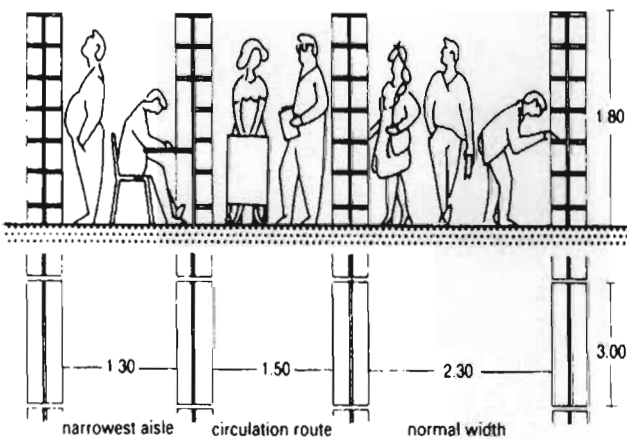

Fig 6.1.15 (Neufert, 2000:330)

A standard five-shelf unit, and the recommended heights of the shelves, is provided below in Fig 6.1.16.

The capacity of standard shelves to accommodate books and periodicals in bound volumes is illustrated in Fig 6.1.17.

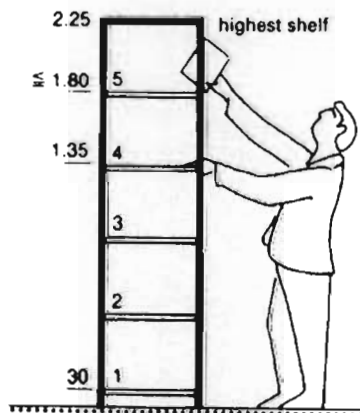
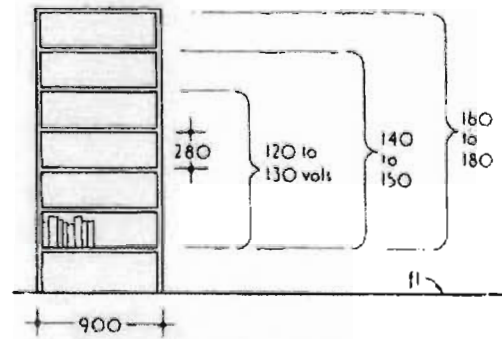
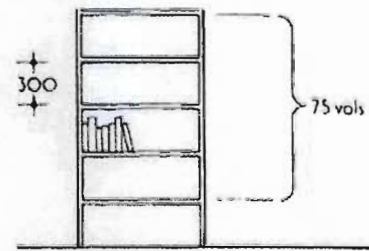

Fig 6.1.16 (Neufert, 2000:330)



Capacity of shelves to hold books, three quarters full to allow for expansion and movement



Capacity of shelves to hold periodicals in bound volumes

Fig 6.1.17 (Adler, 2000:32.4)

- **Reading Area**

A reading or study area is an essential element in a library. This area would offer users a quiet sanctuary for researching, studying or just browsing

The minimum distances between tables are specified below in Fig 6.1.18.

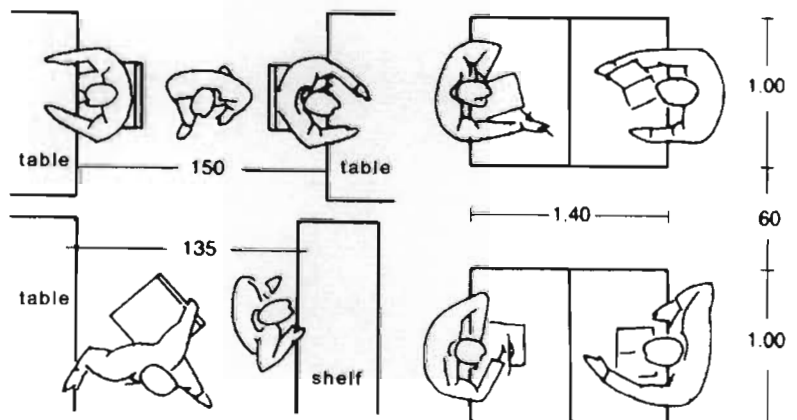

Fig 6.1.18 (Neufert, 2000:330)

- **Reading Lounge**

Another division of the library would be a reading lounge, a comfortable lounge-type environment for casual browsing through periodicals.

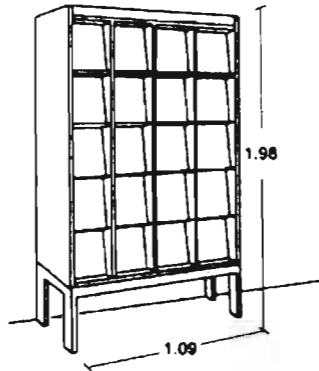

Fig 6.1.19 A standard rack for periodicals.
(Neufert, 2000:330)

- **Archives**

An archive section for drawings and maps would be another necessity in the library. The drawings could include the work of selected students. Respected practices could also donate drawings of their projects to the library archive, creating a highly valuable resource.

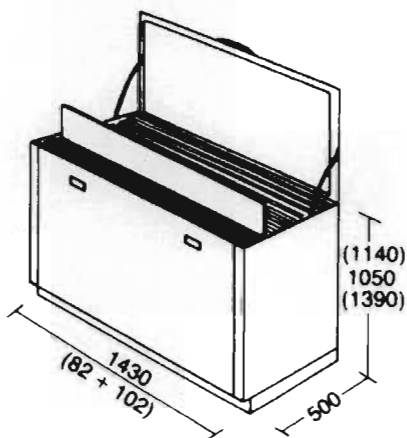

Fig 6.1.20 Drawings stored upright.
(Neufert, 2000:320)

Two types of drawings cabinets which could be used for archives are illustrated in Fig 6.1.20 and 6.1.21.

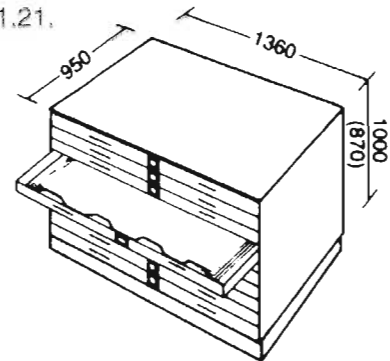

Fig 6.1.21 Drawings stored in draws.
(Neufert, 2000:320)

- **Lighting**

The correct lamps for a library with a ceiling height of between 3 and 5 meters are specified in Fig 6.1.22 and illustrated in Fig 6.1.23.

Lighting provision for a Library with a room height up to 3-5m	
nominal illuminance: up to 750 lux	- QT ≤ 250 W - T - TC - L

Fig 6.1.22 (Drawn from Neufert, 2000:143)

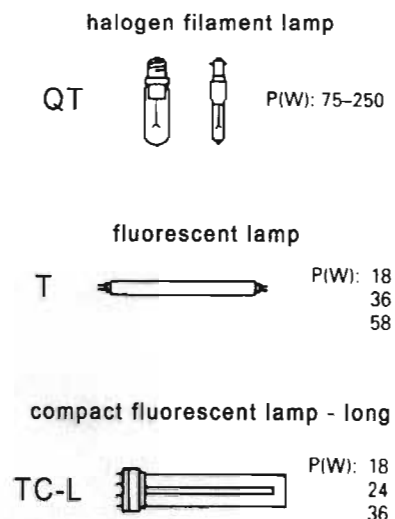

Fig 6.1.23 (Drawn from Neufert, 2000:141)

6.1.5. Administration

- **Description**

The administration component would accommodate office space for the staff of the institute's school of advanced design, as well as the administration of the KZNIBE, including the existing KZNIA.

Office space would be required for at least 8 permanent staff members' responsible for managing the institute's school of advanced design.

The administrators of the KZNIBE, (including a building manager and two secretarial staff) would require a further 3 stations.

- **Staff Lounge and Kitchen**

Discourse is absolutely essential in the sphere of built environment design. Discussions and ideas impacting on the management and direction of the KZNIBE (and the institute's school of advanced design) would be made around the coffee or lunch table.

With this in mind the role of the staff lounge takes on far greater significance and it therefore deserves an equally important position in the structure of the KZNIBE.

A small kitchen for the preparation of teas and lunches would be attached to a staff lounge and dining area.

Not only would this facility be convenient, but it would enable the staff to prepare lunches and eat together, creating more interaction time.

- **Lighting**

The lighting provision required for an office space with a ceiling height of less than 3 meters is provided in Fig 6.1.24 and the various lamps illustrated in Fig 6.1.25.

Lighting provision for an Office with a room height up to 3m	
nominal illuminance: up to 500 lux	- QT ≤ 250 W - TC - D - TC - L

Fig 6.1.24 (Drawn from Neufert, 2000:143)

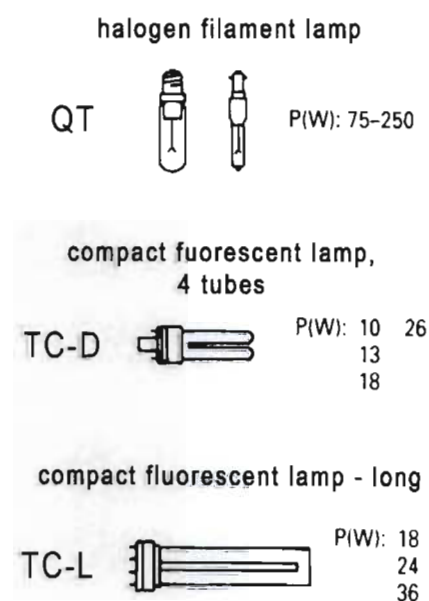

Fig 6.1.25 (Drawn from Neufert, 2000:141)

6.1.6. Studio

- **Description**

A studio would be required to accommodate the students enrolled in institute's school of advanced design in the built environment.

The school would offer a relatively small, select group of students, a two year post-graduate degree in the built environment design discipline of their choice. Each year would consist of approximately 40 students.

One objective of the school would be to broaden a student's understanding and appreciation of design disciplines beyond their particular field of choice, and encourage mutually beneficial interactions between students in other disciplines.

As the school would offer a more discerning student a unique and challenging learning environment, the quality of the studio environment would be especially crucial. The studios should offer students both a sanctuary conducive to contemplation and design, whilst still exhibiting an exiting and inspiring example of exceptional design.

- **Workstations**

The major portion of the studio would be dedicated to the students' workstations. Each

station should be designed to incorporate a computer and tables made broad enough for larger paper sizes.

L-shape workstations are most preferable. As well as enclosing a personal space, they allow students to turn their attention from a computer to hardcopy drawings and visa versa. (Fig 6.1.26)

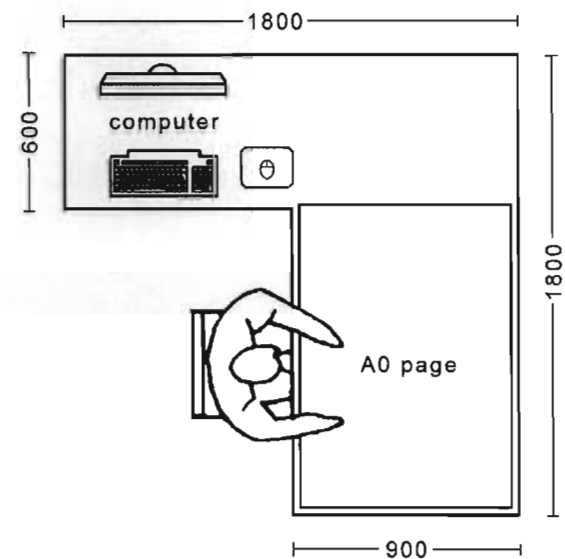

Fig. 6.1.26 L-shaped workstation
(Source: author)

- **Meeting Area**

This area would include a number of large meeting tables that could be used in a variety of ways. In one way it would create an informal design discussion and critique space able to accommodate a number of students and teachers around the table.

Students could also use the area for lunch tables or an alternative work space.

- **Student Lounge and Kitchen**

As with the staff lounge and kitchen, such facilities are not merely for the students' convenience. These facilities would encourage students to spend more time socialising, and working in the studios, rather than at home.

This establishes a collaborative and interactive work environment in the studios where students are able to share ideas and feed off a collectively generated energy.

- **Lighting**

The correct lighting for the studios would be the same as that for the administration areas. However, if the ceiling height of the studios were to fall between 3 and 5 meters in height the illuminance would have to be increased up to 750 lux.

6.1.7. Lecture, Seminar and CAD Teaching Rooms

- **Description**

A small lecture hall, seminar room and CAD teaching room would also be required to complete the KZ'NIBE. These venues would be used by both the Institute's design school and the KZ'NIA. Each should accommodate between 40 to 50 people.

Whilst the lecture hall and seminar room would be used mostly by the design school, the KZ'NIA may also use these venues for smaller CPD presentations.

- **Furniture**

The lecture hall would be raked and furnished with rows of swing-up seats and writing shelves. The incline could either be stepped or a gentle gradient. (Fig 6.1.27)

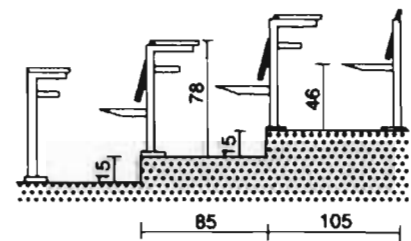

on 150 mm steps

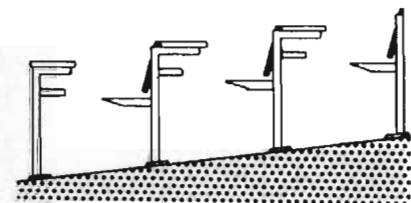

slope of up to 12°

Fig 6.1.27 Stepped and sloped lecture halls (Neufert, 2000:318)

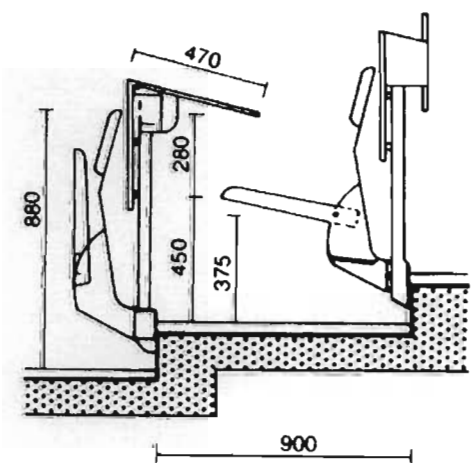

Fig 6.1.27 Detail of swing-up seat and writing shelf (Neufert, 2000:318)

The seminar room would be a flexible space with a level floor and loose furniture that can be arranged in a variety of ways. (Fig 6.1.28)

A room with square proportions like those illustrated below are more flexible than long narrow spaces.

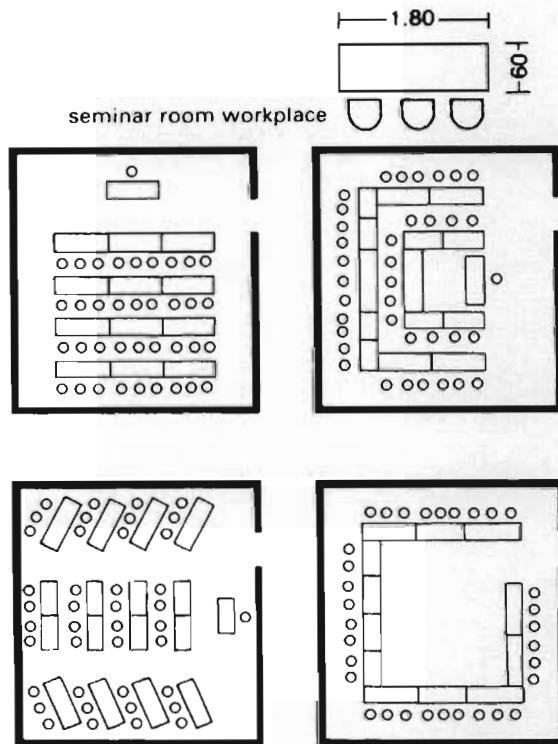

Fig 6.1.28 Variable seating arrangements in a seminar room (Drawn from Neufert, 2000:319)

The CAD teaching room would be a classroom-type space including at least 40 computer workstations, all facing a projection screen at the front of the room.

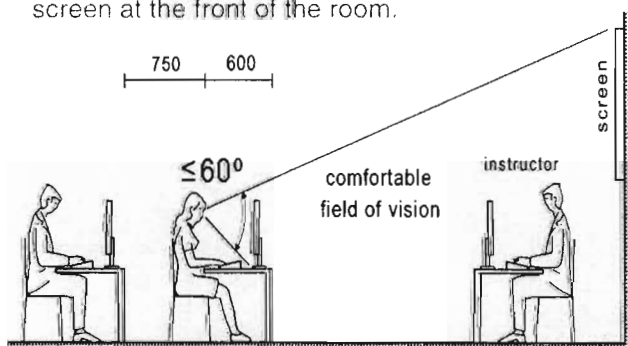

Fig 6.1.29 Section through CAD teaching room (Drawn from Neufert, 2000:351)

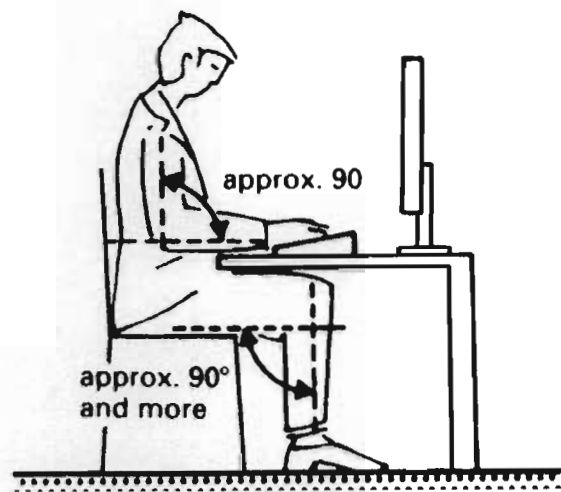

Fig 6.1.30 The ergonomics of a workstation (Drawn from Neufert, 2000:351)

- **Lighting**

The lighting required for the lecture hall and seminar room is provided in Fig 6.1.31.

Lighting provision for Lecture Halls and Seminar Rooms with a room height up to 3-5m	
nominal illuminance:	- QT ≤ 250 W
up to 500 lux	- T
	- TC - L

Fig 6.1.31 (Drawn from Neufert, 2000:143)

The lamps listed in Fig 6.1.31 are illustrated in Fig 6.1.25.

The lighting required for the CAD teaching room would be the same as for the administration areas.

6.2. Accommodation Schedule

NAME	SIZE	LINKED TO	PUBLIC / PRIVATE
Exhibition space	450 m ²	catering facility, (entrance)	public
Exhibit prop store room	100 m ²	exhibition space, (service gate)	private
Workshop	150 m ²	exhibit prop store room, (service gate)	private
Auditorium	200 p	catering facility, (entrance)	public
Rear projection room	-	auditorium	private
Catering space	200 p	auditorium, exhibition space, (entrance)	public
Snack-bar (behind counter)	20 m ²	Catering space, cold store, (service gate)	private
Cold store room	10 m ²	Snack-bar, (service gate)	private
Library	-	studio, administration, (entrance)	public
Issue desk	15 m ²	library entrance, book stacks	
Book stacks + archives	120 m ²	issue desk	
Reading area	60 m ²	book stacks + archives	
Reading lounge	40 m ²	periodical shelves	
Administration	-	studio, library	private
KZNIBE administration	30 m ²	front of admin, board room	
Board room	30 m ²	front of admin	
School staff	140 m ²	board room	
Staff kitchen	20 m ²	staff lounge + dining, board room	

Staff lounge + dining	60 m ²	staff kitchen	
Studio	320 m ²	Library, lecture hall, seminar room, CAD teaching room, administration	private
Meeting area	60 m ²	studio, student kitchen	
Student lounge	40 m ²	studio	
Student kitchen	30 m ²	studio, meeting area	
Building Yard	40 m ²	(service gate)	private
Lecture hall	50 p	Studio, (entrance)	public
Seminar room	40 p	Studio, (entrance)	public
CAD teaching room	40 p	Studio, (entrance)	public
Toilets	-	separate facilities for public, staff and students	-
Cleaners store	10 m ²	(centrally positioned)	-

7.1. Site Criteria

7.1.1. Urban Characteristics

- **Prominence of the Site**

As the KZNIBE's major role would be to promote the built environment professions to the public and stimulate public interest in their surrounding built environments. The prominence of the site in the public eye is crucially significant to its success.

- **Size of Site**

As the KZNIBE includes both an auditorium and substantial exhibition space which would both preferably be placed at ground floor for ease of access, the building would have a relatively large footprint, and therefore require an exceptionally large site. This requirement immediately eliminates most potential vacant sites in the city.

- **Urban Infrastructure**

The nature of the building means that a large number of staff as well as students and visitors will need to gain easy access to the site. An existing infrastructure including a good road network and public transport will ensure that the building's location does not restrict people from being able to easily access it.

In order to provide the appropriate facilities the site should also offer basic municipal services.

- **Surrounding Land Use**

The KZNIBE would be best suited in a mixed use environment, as this would support the facilities available in the building. For example, the students would need convenient accommodation as well as basic retail support.

The involvement of the built environment professionals is another important aspect, and it would be preferable if the offices of some of these professionals were in the surrounding area.

- **Urban vs Rural**

It is important that the site is in an urban environment as opposed to a rural or even semi-urban or semi-rural area. Again this is an issue of access and being able to attract the greatest number of people and encourage public interaction.

The building may however be more suited to an area zoned for lower densities. This would allow more space around the building, providing a greater potential for natural ventilation and lighting, with reduced noise and air pollution.

- **Supporting Education Facilities**

The Institute's school of advanced design would not be a stand-alone educational facility as there are already two institutions in Durban that offer an education in the built environment disciplines. Furthermore, as the institute's school would only offer postgraduate degrees, it would need to draw its students from other institutions.

In order to assist in establishing positive ties with UKZN's School of Architecture Planning and Housing and DUT's Architecture, Landscaping and Interior Design departments, it would be preferable for the KZNIBE to be positioned within close proximity of both institutions.

7.1.2. Social Considerations

The KZNIBE should be inserted into an area in which it is able to affect a significantly positive influence.

Within the greater city of Durban precincts have emerged which each have their own character and identity. It is important that the site chosen for the KZNIBE is situated in a precinct that will suit its role in society.

An emerging precinct would be preferable, allowing the KZNIBE to contribute to its continued development.

7.1.3. Environmental Considerations

- **Orientation**

Orientation of the site, although not fundamental to the choice of the site is a still a consideration. A site that is orientated in a way that allows the building to align with a north-south axis is preferred so that sunlight can be easily controlled, creating a more comfortable environment.

- **Natural Ventilation**

In order to achieve natural cross-ventilation, the building's modules should not exceed 15 meters in width. On a restricted inner city site this might prove a great challenge, or even impossible. It is therefore preferable that the site for the KZNIBE lends itself to narrow sections of building, that allow for efficient cross ventilation.

- **Noise Levels**

As the KZNIBE would include places of quite contemplation, noise levels would need to be controlled. This could be achieved through built means, though natural barriers such as vegetation and topography can also help to control noise. However, since the building should be naturally lit and ventilated, a site with relatively low noise levels or one that offers natural sound barriers would be favourable.

7.2. Site Options:

Sutton Park, Wharf Site and Bulwer Park

7.2.1. Introduction

Three potential sites were selected for the location of the proposed KZNIBE. Most empty plots in the city were immediately eliminated due to their inadequate size or inappropriate urban context.

The three potential sites to be examined are Sutton Park, the Wharf Site and Bulwer Park.

(Fig 7.2.1)

7.2.2. Locations

The first site is in Sutton Park in Morningside. The park is located between Windermere, Sutton, Adrain and Stamford Hill Roads.

The second site, the Wharf site, is situated adjacent to the Wilson's Wharf development, on a large deserted plot near the waters edge.

The third site is located at the bottom of Bulwer Park in Glenwood. The corner site is at the intersection of Bulwer and Davenport Roads.

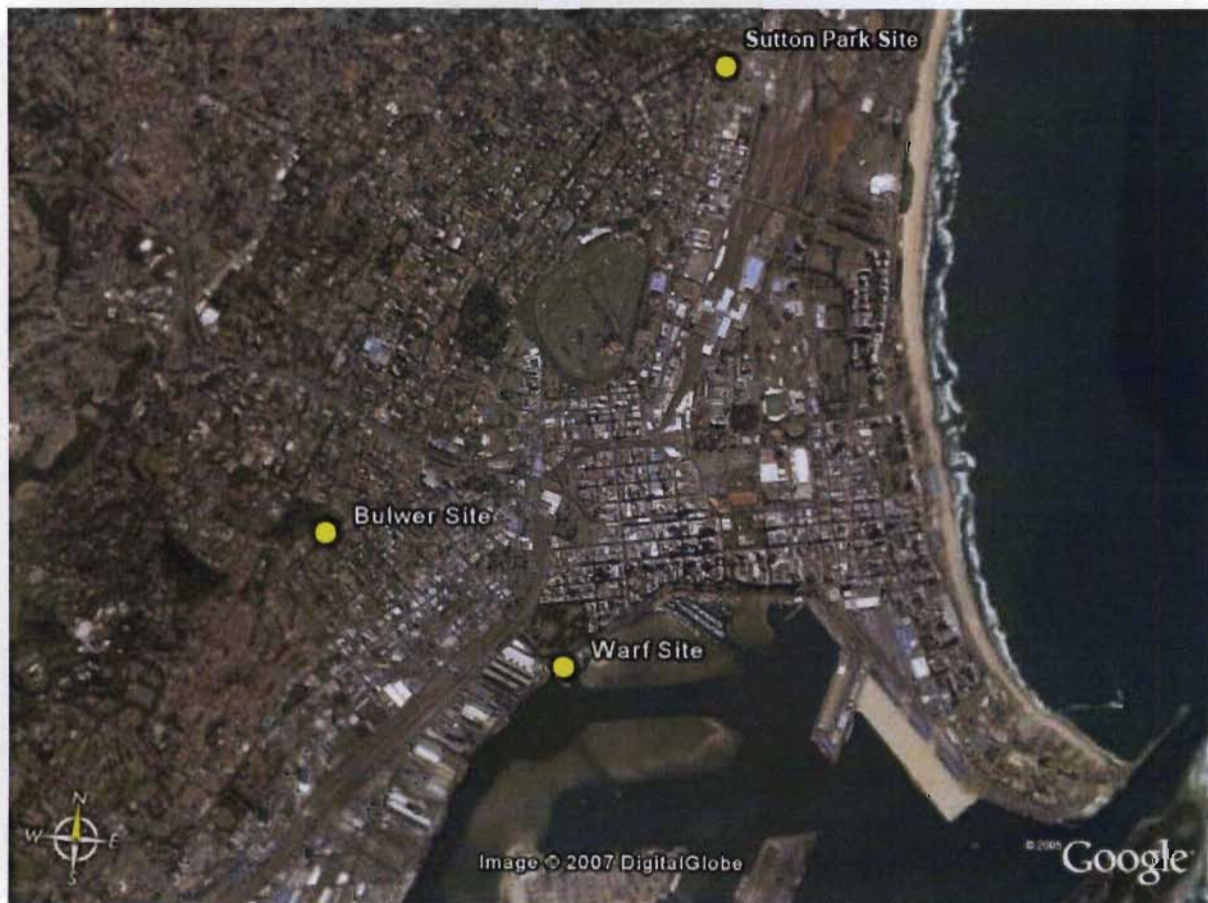

Fig 7.2.1. The location of the three site options in Durban. Google Earth 2007

7.3. Site Option 1 – Sutton Park



Fig 7.3.1. Sutton Park. Durban Municipality 2007

7.3.1. Introduction

Sutton Park is a triangular public park in lower Morningside. There is a public pool in its southern corner, which is well used, although the rest of the park appears neglected and predominately occupied by vagrants. The selected strip at the northern end is an area of 9290m² and contains many well established trees. The immediate neighbourhood consists of a mixture of residential, commercial and educational activities.



Fig 7.3.2. Sutton Park. (source:author)

7.3.2. Urban Characteristics

The site is situated just 300 meters north of a relatively major node formed by Windermere Shopping Centre and just 700 meters south-west of the new soccer stadium for the 2010 world cup. It is surrounded by a few residential blocks, a school, and old houses which have been converted into offices.

Windermere Road is the major route through the area and offers the site some degree of exposure, however, only a small edge of the site borders the road. Adrain Road on the other hand creates the longest boundary along the northern edge, however this road is especially quiet, and as a result the park is largely secluded from the public eye.



Fig 7.3.3. *Adrain Road and the northern edge of Sutton Park. (source:author)*

Nevertheless the site is large, and could accommodate the necessary functions of the KZNIBE comfortably.

The sites close proximity to the city centre, and position on Windermere Road, which is a major public transportation route, makes it easily accessible.

Whilst the area is fairly urban, comprising a relatively high ground level density, with the exception of the Windermere Centre and a few other multi-storey blocks, the general density of the area is rather low. Most surrounding buildings are one or two storeys.



Fig 7.3.4. *Windermere Centre as seen from the site, as it looms over a comparatively small residence. (source:author)*

Although there are many schools located nearby, the major high schools and tertiary educational facilities are a fair distance away.

7.3.3. Social Considerations

The surrounding precinct includes mostly commercial activities; many older residential properties have been converted into offices. However, few of them interact well with the street edge, and their activities do not form a cohesive node. (Fig 7.3.5)

With the exception of those using the public swimming pool, the site seems disregarded the by public. Its location is however convenient and prominent enough not to compromise its potential to be a destination well used by the public, which would add great value to the neighbourhood.



Fig 7.3.5. *Two of the older houses opposite the site in Stamford Hill Road which have been converted into small offices. (source:author)*

Because the site is not situated in an existing cultural precinct, it could either result in the KZNIBE becoming insular and isolated within its context, or could potentially allow the KZNIBE to act as a catalyst for other related initiatives in the area.

7.3.4. Environmental Considerations

The sites long rectangular shape provides superb orientation, with long north and south edges, and short east and west ends.

The shape also lends itself to a long, narrow building which assists a natural ventilation strategy. This, together with the good orientation ensures that natural light could be easily utilised.

Although Windermere Road is very busy and may cause high noise levels, the other roads are not as congested and this problem could be dealt with in the architectural solution.



Fig 7.3.5. *The busy junction of Sutton Road into Windermere Road. (source:author)*

7.3.5. Conclusions

Sutton Park has environmental characteristics that suit the proposed KZNIBE, as well as being an appropriate size.

However, the precinct does not provide the activity or cohesiveness that would be required for the institute to become a valuable part of the community. The supporting facilities and land use of the surrounding sites would not aid the institute in becoming a high activity node, and prominent feature in Durban.

7.4. Site Option 2 – Wharf Site



Fig 7.4.1. Wharf Site. Durban Municipality 2007

7.4.1. Introduction

The wharf site, on the city side of Durban's harbour, is adjacent to the Wilson's Wharf entertainment node. The vacant site is 6800m² in size, and includes some small abandoned small sheds around its perimeter.



Fig 7.4.2. Wharf Site. (source:author)

7.4.2. Urban Characteristics

The site is separated from the rest of the city by a major roadway and railway line. This disconnection isolates the site from the view of passing public and eliminates its potential for visual prominence.

The size of the site is however appropriate for the KZNIBE, and the nearby apartment blocks could provide student accommodation. Although security is an issue in this vicinity, the insertion of the KZNIBE could aid in continuing the upgrade that has already begun in the area.

Public transport and infrastructure is good in this area, however the site itself is rather remote and some distance from the Esplanade, which is the closest public transport route.

The edge of the city is dominated by high rise apartment blocks, and a large public park (Albert Park), while the harbour edge has traditional harbour characteristics, such as yacht moles, boatyards and warehouses, as well as restaurants and other recreational activities.

An educational facility does not naturally fit into this precinct, which does not have any connection to other tertiary educational facilities in the city. As a result the KNZIBE would become a destination building rather than another node on an existing route of activity.



Fig 7.4.3 *The iconic sugar terminals neighbour the site. (source: author)*

The buildings on the city side of the Esplanade are high density, whilst the harbour side has a low density. The KZNIA would suit the scale and proportion of the harbour buildings, and benefit from the fantastic harbour views. (Fig 7.4.3)



Fig 7.4.4 *A view from the site across the harbour. (source: author)*

7.4.3. Social Considerations

Although the addition of the KZNIBE could continue the current upgrade of the harbour edge, and enhance the area, increasing public use of the zone and improving security, the building itself may suffer from the sites isolation.

People specifically visit the restaurants at the harbour edge to sit and eat whilst enjoying the harbour views. For this reason they survive, even though they are an isolated destination.

An event at the KZNIBE would however be an attraction in itself, and whilst harbour views are nice to have, site centrality and prominence would be more influential to its success.

7.4.4. Environmental Considerations

The site is slightly rotated off the north south axis and like the Sutton Park site is long and rectangular, implying a structure with lengthy north and south facing facades, whilst allowing narrow cross-sections to assist natural ventilation.

The site is however subjected to strong south-westerly winds off the harbour which bring rain.

Although the site is close to major roadways, it is not too badly affected by traffic noise, and the occasional sounds emanating from the harbour could create a pleasant dock-side atmosphere.



Fig 7.4.5 *A boat-yard adjacent to the site.*
(source: author)

7.4.5. Conclusions

This site is located in an interesting environment that has great potential to offer a stimulating experience to those who would use the building. However, the isolation of the site becomes a strongly negative aspect. It limits accessibility and the prominence of the building in the public eye, which is of crucial importance to the success of the KZNIBE.



Fig 7.4.6 *Existing abandoned buildings on the edge of the site, and the city skyline in the background, highlights the contrast in scale.*
(source: author)

7.5. Site Option 3 – Bulwer Park



Fig 7.5.1. *Bulwer Park.* (Durban Municipality 2007)

7.5.1. Introduction

Bulwer Park, situated in Glenwood, is an exceptionally large public park with many large established trees. The portion of the park considered as a potential site is 9540m² in size and is currently used as a children's playground.



Fig 7.5.1 *The Bulwer Park site.* (source: author)

7.5.2. Urban Characteristics

The park is a prominent feature in Durban, and more specifically in Glenwood, due to its extraordinary size. The portion of park marked for consideration sits at the intersection of Bulwer and Davenport Roads, both major thoroughfares through Glenwood. This prominent corner site would offer KZNIBE building an opportunity to be particularly visible to the Durban public.

The existing infrastructure around the site is good. Bulwer Road is a major public transportation route, and the commercial node that has developed from the intersection of

Davenport and Bulwer Roads down to Davenport Centre would act as supporting infrastructure. The more recent of these developments was the establishment of a Woolworths food store on the corner opposite the site, and the addition of a number of restaurants along Davenport Road. (Fig 7.5.2) This growth has drawn people to the area, and established a new node of activity in Durban.



Fig 7.5.2 Davenport Road has become a 'buzz' since many of the old houses have been converted into restaurants. (source: author)

The land use in the area is mixed. The site is surrounded by residential blocks and houses, offices, restaurants, retail, a school and a sports club. Both the KwaZulu-Natal Institute

of Architecture and the KwaZulu-Natal Society of Arts are situated just adjacent to the site, and together have established somewhat of a cultural node in the neighbourhood.

This part of Glenwood is an older suburb in Durban, and although plots are small, the area varies in density. Whilst the zone below Bulwer Road still consists mainly of old houses (even though many are now used commercially), higher residential blocks dominate the upper portion of Davenport Road towards Manning Road. (Fig 7.5.3)



Fig 7.5.3 One of the larger residential blocks just above the site in Davenport Road. (source: author)

The site is located centrally between the University of KwaZulu-Natal and the Durban University of Technology, and linked by major roads across the Berea.

7.5.3. Social Considerations

The existing activities in the area surrounding the site interact well with the street and encourage the public to experience the entire precinct by drawing one along the road from one activity to another. This sort of public engagement is an essential requirement for the site of the KZNIBE.

However, the park itself has become a haven for vagrants and criminals. The historically significant municipal buildings which sit on the site are now abandoned and seriously dilapidated. And although these listed buildings are protected, they are being 'demolished' by neglect. Instead of being an asset, in this regard the park depreciates the area.



Fig 7.5.3 Gatehouse pavilion. (source: author)

The placement of the KZNIBE on the site would help deal with these issues. The municipal buildings could be restored and reused. Increased use of the park, and

relocation of the playground into a disused portion, should improve overall security. The KZNIBE would also add to, and further establish the cultural precinct, which has evolved in recent years.

7.5.4. Environmental Considerations

Though none of the triangular shaped site's edges are well aligned in terms of solar orientation, the site is large enough to accommodate a well orientated building in its centre, whilst still maintaining most of the existing trees.

Traffic noise from Bulwer Road may be an issue at peak hours, but the problem seems manageable, and the existing vegetation should act as an acoustic buffer. The natural and spacious character of the site would also assist in creating a building that is naturally ventilated.



Fig 7.5.4 Bulwer Road – a major thoroughfare through Glenwood. (source: author)

7.5.5. Conclusions

The site is prominent and would offer the KZNIBE fantastic exposure. The node of activity that has already developed around the site generates a great deal of public interest in the area, and the KZNIBE would benefit considerably from been a part of this exiting precinct.

Use of the site would also achieve a positive regeneration and public reclamation of the park, and deal with the restoration and maintenance of the three historically valuable buildings.



Fig 7.5.3 A historically valuable abandoned sub-station building on the site. (source: author)

7.6. Site Choice – Conclusions

The Bulwer Park site is surrounded by activities which would complement the KZNIBE and support its objectives. The site would offer the KZNIBE the opportunity to connect with the KZNSA gallery and 106 Bulwer Road, (which may continue to be occupied by the Durban Heritage Trust).

The cultural precinct which has sprung up in the neighbourhood in recent years would surely appreciate the addition of the KZNIBE, which would certainly add great value the area.

The building must take advantage of the prominence of corner at the intersection of Bulwer and Davenport roads. This 'dead' corner currently offers no value to the area, and yet could offer the KZNIBE the opportunity to be the landmark building in the neighbourhood.

During the production of this document, the sub-station buildings on the Bulwer site were fenced off with razor wire in order to prevent their use by criminals and further vandalism. This action further stresses urgency for something to be done with these valuable buildings and surrounding site.

	Sutton Park	Wharf Site	Bulwer Park
Size			
Orientation			
Quality of Environment			
Accessibility			
Visibility			
Surrounding Building Scale			
Existing Precinct			
Noise Pollution			
Access to Public Transport			
Need for Development of Site			

key: poor adequate good

7.7. Site Analysis – Bulwer Park

7.7.1. Location

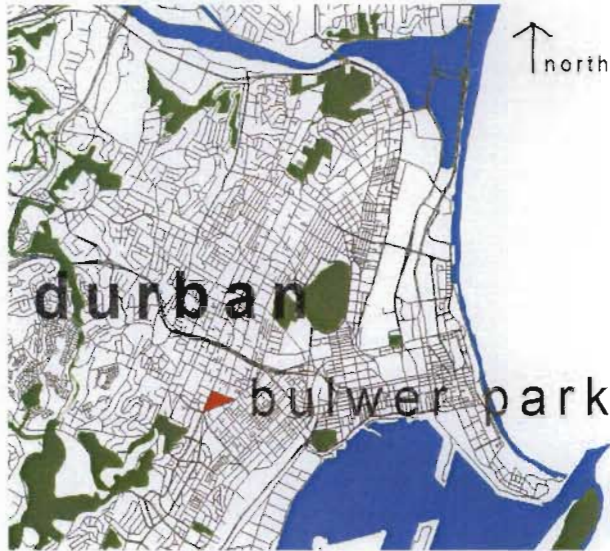

Fig 7.7.1 Location Map.

(Drawn from Durban Municipal Map, 2007)

Bulwer Park is located in the suburb of Glenwood on Durban's Berea. Although, it is a predominantly residential area, there has been an increasing amount of commercial, recreational and cultural activity in the last decade.

The Park was established in 1905 as a public park and remains as one of the largest open spaces in the city.

The portion of the site proposed for the development of the KZNIBE is on the eastern corner of the triangular park. (Fig 7.7.2) It is bounded by roads that define it from the rest of the park and currently includes a small playground and three neglected buildings.

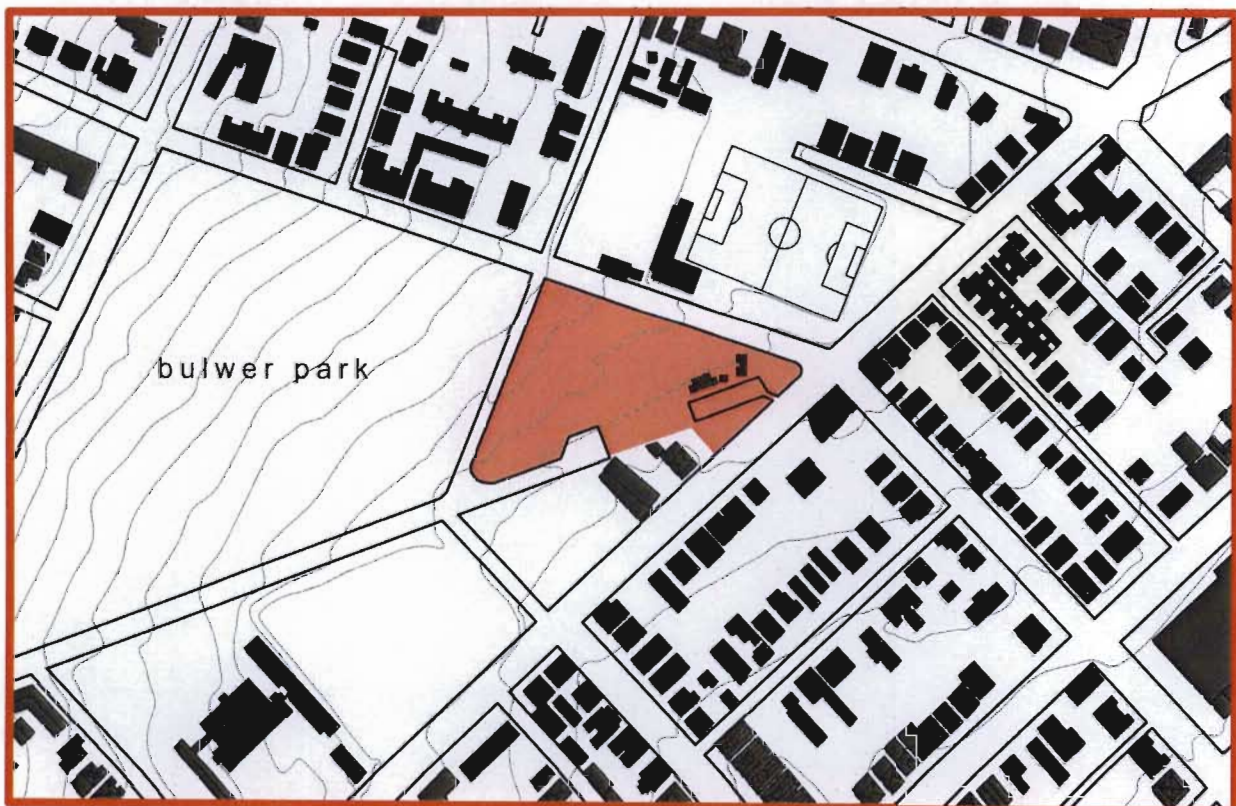
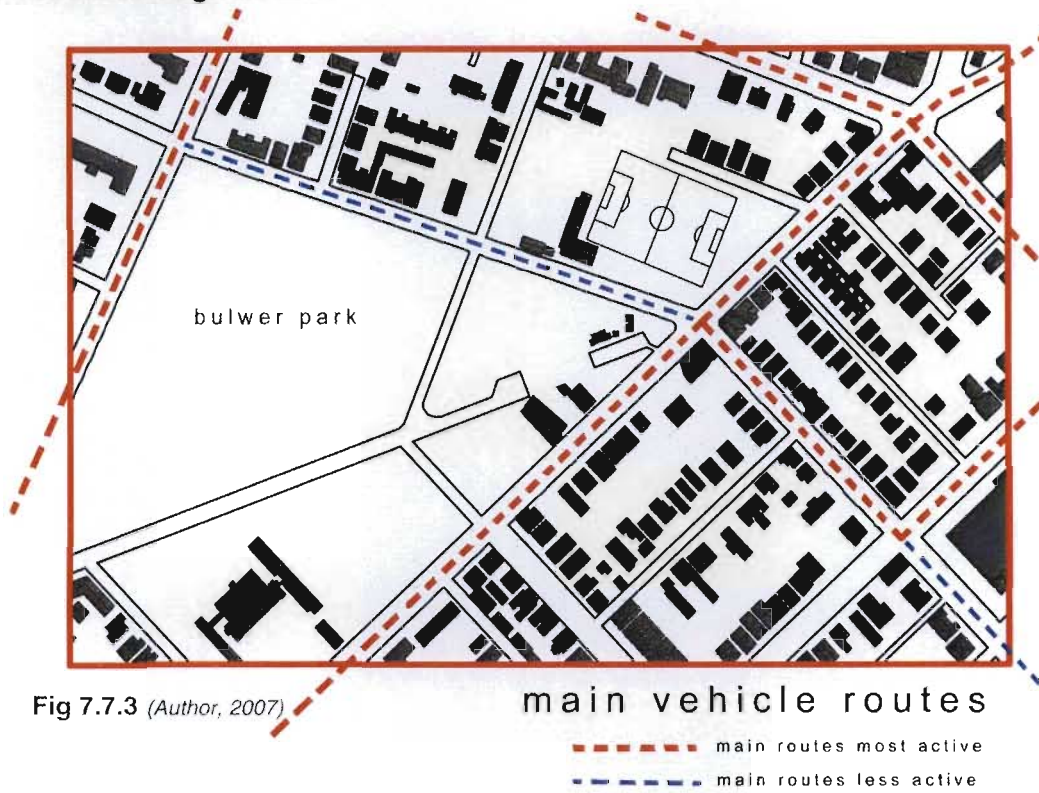

Fig 7.7.2 Figure ground highlighting the site

(Author 2007)

7.7.2 Routes through the Site



The route along Bulwer, Davenport and Brand Roads are long standing thoroughfares through Glenwood. (Fig 7.6.3) The result is that most of the commercial activity and historically significant buildings in the area are located along this route. (Fig 7.6.5)

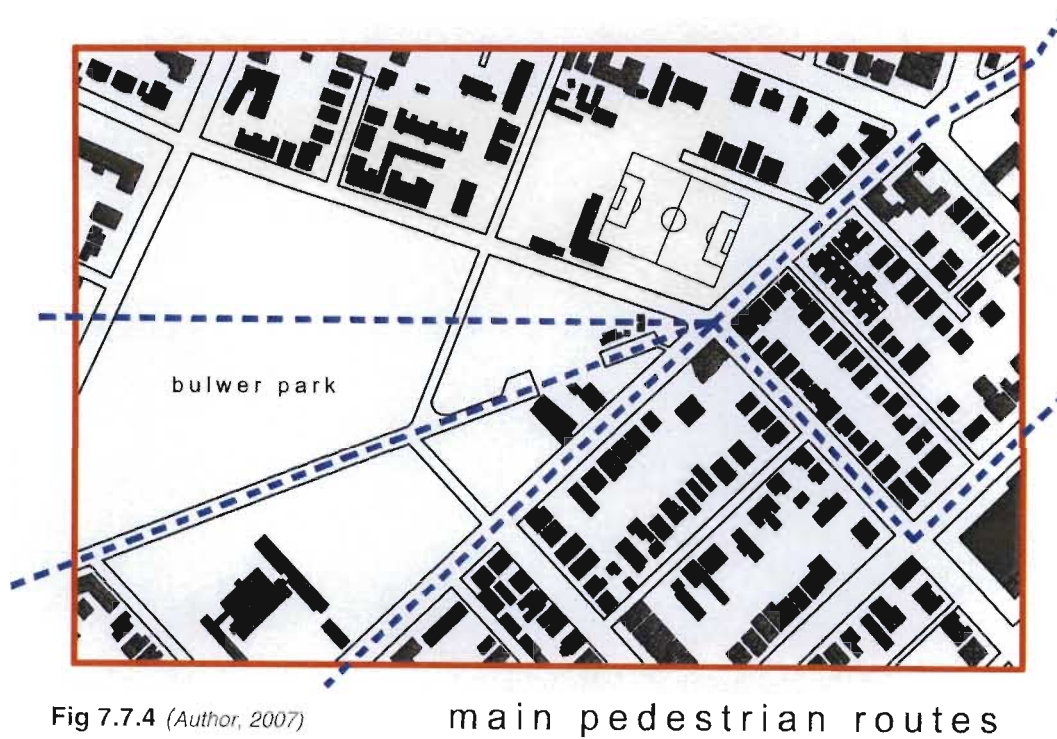

7.7.3. Surrounding Building Use



Fig 7.7.5 (Author, 2007)

building use survey



The map above shows the extent of commercial activity along the Davenport Road node. The character of the 'old houses' and quality of the street make this an attractive location for restaurants and other business. The typical cross-section through Davenport Road illustrates this quality. (Fig 7.6.6)

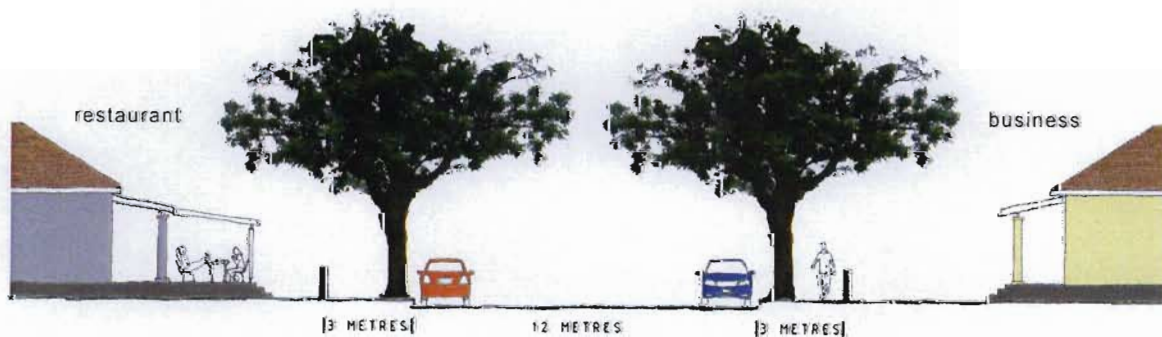

Fig 7.7.6 (Author, 2006)



6 storey apartment block



3 storey art deco building



6 storey apartment block



Stella sports club



Woolworths



Davenport Center apartments & offices (12 storeys)



Gable front Edwardian house



'Breathing Space' yoga studio

3D model of site and surrounding buildings

(source: author)

7.7.4. Existing Buildings on the Site

1905 park buildings



Fig 7.7.7 Electrical sub-station. (Author, 2007)

Brian Kearney describes the two buildings in Fig 7.79 this:

Entrance Gatehouse to Bulwer Park: A single storied, Union period pavilion in Berea style, with hipped tiled roofs and ventilator. Prominent park corner site. (C1905)



Fig 7.7.7 The terrible state of the Bulwer Park buildings (Author, 2008)

Substation, Bulwer Park: An electrical substation of Edwardian period in Baroque Revival style. Significant plaster details. (C1905) (Kearney, 1984)



Fig 7.7.9 Electrical sub-station and gateway to the park - toilet pavilion. (Author, 2007)

7.7.5. An Appropriate Response to Climate

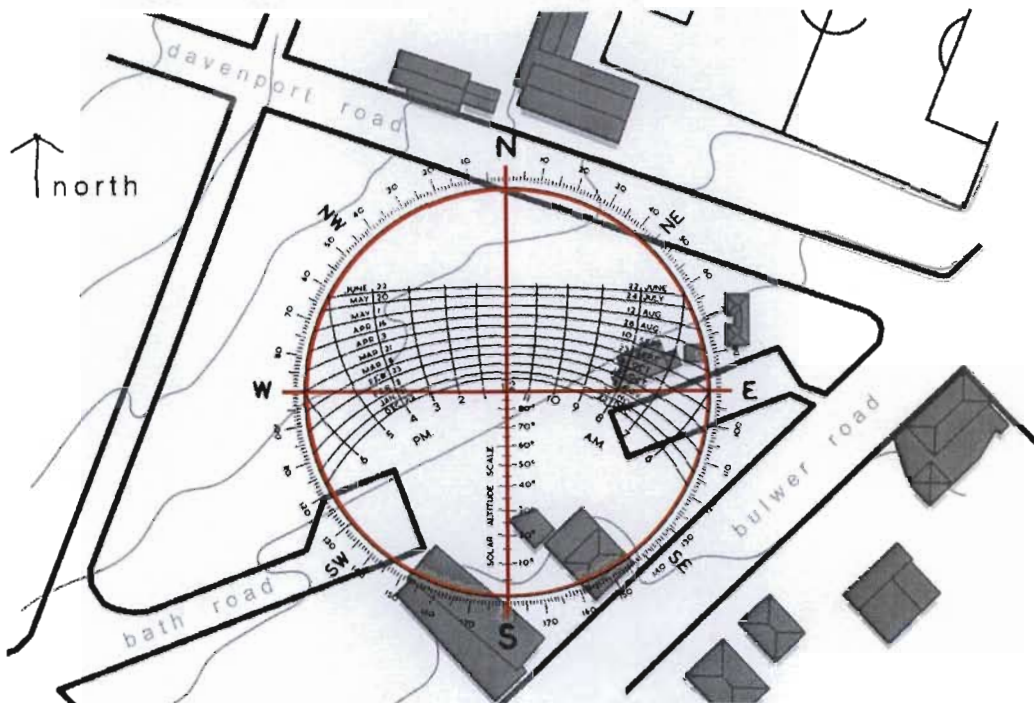

Fig 7.7.10 Sun path diagram on the site (Author:2007)

Climate

"The climate is characterised by high temperatures and high humidity levels. The daily temperature variation is small. Winters are warm. Coastal winds are always present. This region's climate is the closest to an equatorial hot humid climate that is to be found in Southern Africa." (Holm, 1996:49)

Design

According to Holm, buildings in this region should be free-standing to allow air movement through. Narrow plan shapes with a single row of rooms are preferable, because they allow cross ventilation. The North and South sides of the building should be the longest.

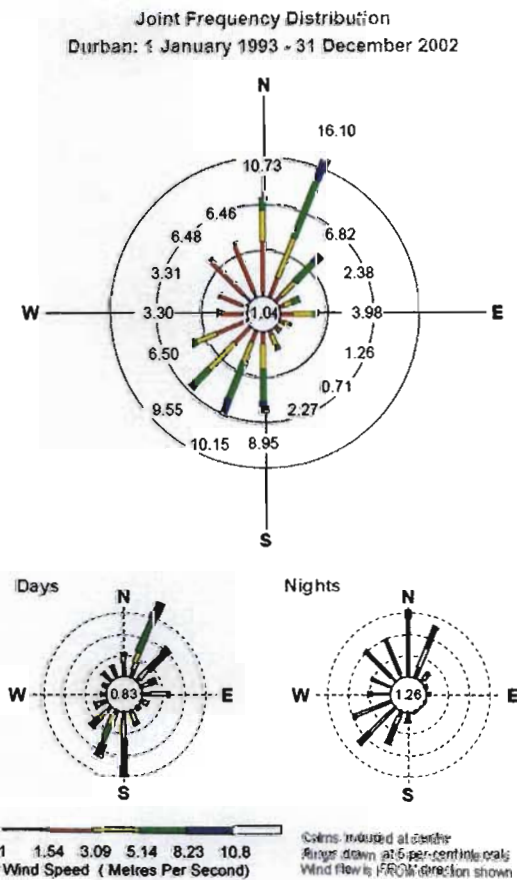

Fig 7.7.11 Wind rose for Durban (Holm, 1996:50)

"Lightweight construction is applicable for walls and roof. Thermal mass is not effective. Ground contact brings no advantage because of high soil temperatures. Insulation in walls is not necessary if they are totally shaded. Roofs are also lightweight, but should preferably be shaded. Roof spaces can also be ventilated." (Holm, 1996:49)

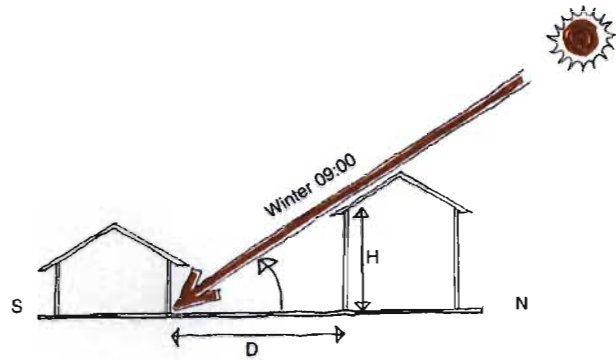

Fig 7.7.13 Solar access for building spacing in Durban during winter (Holm, 1996:51)

Sun Angles

The sun should be totally screened during the summer months, and yet allowed to enter from the north during the coldest winter months, and therefore warm the building. This can be achieved by creating the appropriate roof overhang on the north facade. (Fig 7.7.12)

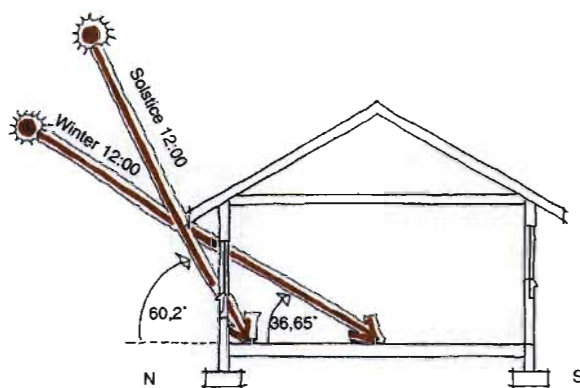

Fig 7.7.12 Appropriate roof overhang on the North facade (Holm, 1996:52)

Buildings should also be appropriately spaced to allow for sun penetration in the winter months. (Fig 7.7.13)

Ventilation

"Adequate ventilation is necessary to remove excess humidity and provide thermal comfort. Ventilation is effective for the entire overheated period. East and West facing walls should not have windows, but the other facades must allow for maximum penetration of wind.

Openings for windows should be large and air flow should preferably not flow over exterior hot surfaces. Ventilation openings other than windows can also be considered."

(Holm, 1996:49)

The prevailing wind directions in Durban are from the north-east and the south-west. (Fig 7.7.11) These can be exploited for natural ventilation, especially the north-east which almost always blows on hot summer days. The south-west wind however usually brings rain.

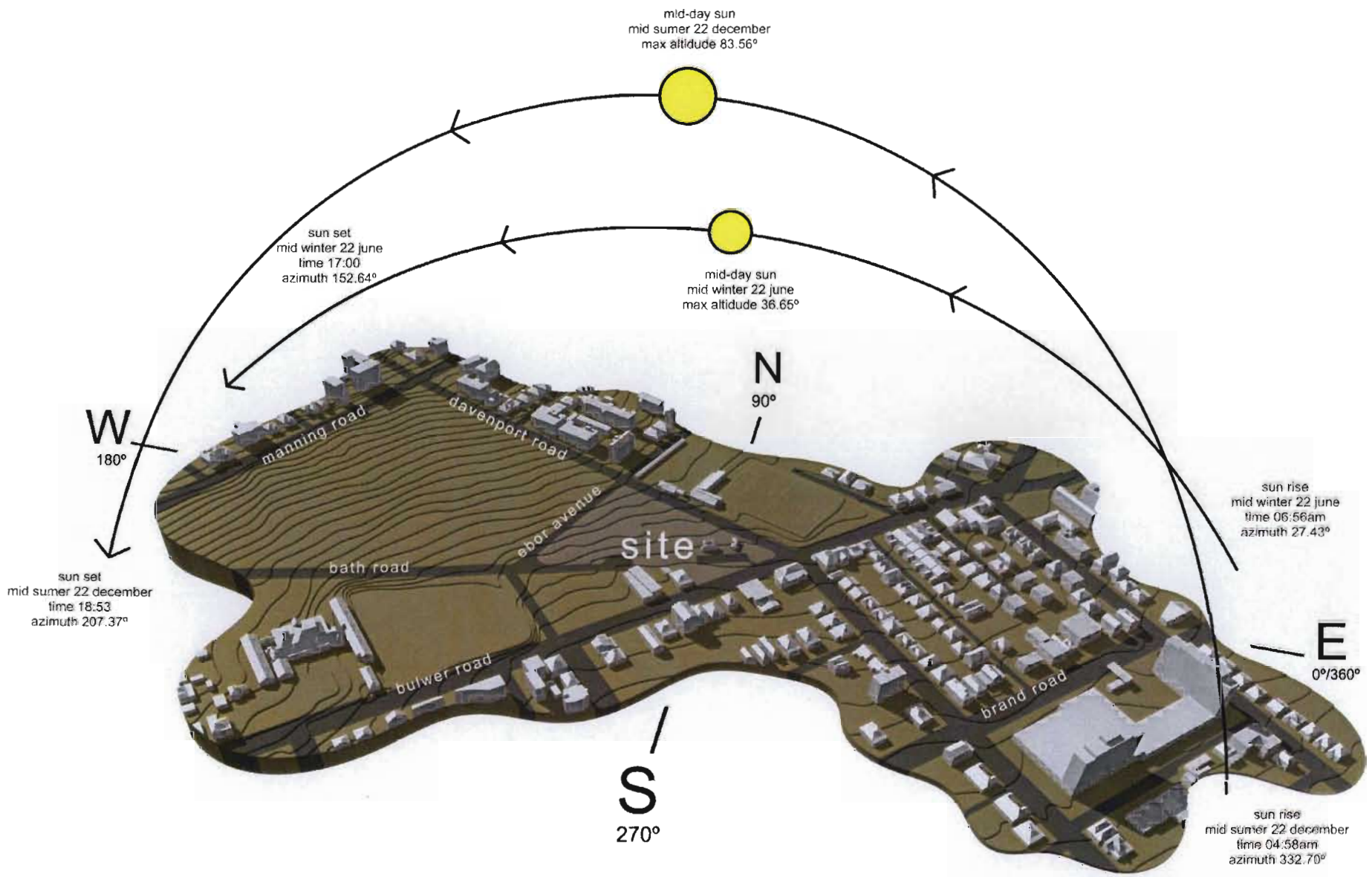

3D model showing summer + winter sun paths

(source: author)

References

- **Adler, D.** *Metric Handbook, Planning and Design Data*; 2000, London, The Architectural Press
- **Bartuska, T.J. & Young, G.L.** *The Built Environment – a creative inquiry into design and planning*; 1994, Menlo Park (California), Crisp Publications.
- **Beck, H. & Cooper, J.** *Glenn Murcutt, A Singular Architectural Practice*; 2002, Images Publishing, Australia.
- **Brandon, P.S.** *Evaluating Sustainable Development: in the built environment*; 2005 Blackwell Science, Oxford.
- **Chance, P.** *Learning Through Play: Proceedings of the Round Table on Play and Learning*; 1979, New York, Gardner Press.
- **Collier, T.** *Design Technology and the Development Process in the Built Environment*; 1995, London, E & FN Spon.
- **Croft, L.T.** *University of Natal: A New Building for the School of Architecture and Other Departments*; 1970 Durban, University of Natal.
- **Dearstyne, H.** (edited by Spaeth D.) *Inside the Bauhaus*; 1986 London, The Architectural Press Ltd.
- **Hays, K.M.** *Architecture Theory since 1968*; 2000, Cambridge, MIT Press.
- **Holm, D. & Viljoen, F.** *Primer for Energy Conscious Design* ; 1996, Pretoria, Department of Minerals and Energy

- **Holm, D.** *Manual for Energy Conscious Design*; 1996, Pretoria, Department of Minerals and Energy
- **Kearney, B.** *A Revised Listing of Important Places and Buildings in Durban*; 1984, Durban City Council
- **Low, I.** *A New School of Architecture in South Africa? A study lead by Architects Support Group for South Africa (ASGSA – UK)* 1997 Daedalus.
- **Lynch, K.** *The Image of the City*; 1960, Cambridge, MIT Press.
- **Monk, T.** *The Art and Architecture of Paul Rudolph*; 1999 London, Wiley-Academy.
- **Neufert P. & Neufert E.** *Architects Data, Third Edition*; 2000 Oxford, Blackwell Science
- **Reekie, R.F.** *Design in the Built Environment*; 1972, London, Edward Arnold Ltd.
- **Siza, A.** *68/69 + 95 Alvaro Siza*; 1995, Madrid, El Croquis.
- **Sliwa, J & Fairweather, L.** *AJ Metric Handbook, Third Edition*; 1972, London, The Architectural Press
- **Testa, P.** *Alvaro Siza*; 1996 Berlin, Birkhauser.
- **Tutt, P & Adler, D.** (editors) *New Metric Handbook*; 1979, London, The Architectural Press

- **University of Natal, School of Architecture.** *New School of Architecture*; 1969. Durban.
- **University of Natal, School of Architecture.**
The School of Architecture, University of Natal: 1949 – 1970. 1970. Durban.
- **University of Natal. School of Architecture, Planning and Housing.**
Programmes in Architecture: University of Natal, Durban, South Africa; 2002. Durban.
- **Venturi R. et al.** *Learning from Las Vegas (revised edition)*; 1989, Cambridge, MIT Press.
- **Venturi R.** *Complexity and contradiction in architecture*; 1966, New York, Museum of Modern Art.

10. Related research: unpublished dissertations

- **Hallen H.** *A School of Architecture for the University of Natal*, 1953 (BArch)
- **Mikula P.** *A School of Architecture*, 1967 (BArch)
- **Neal, R.I.** *A School of Architecture and Fine Art*. 1988 (BArch)
- **Mavuso, B.** *School of Built Environment, University of Swaziland, Kwaluseni*, 2004 (BArch)
- **Pillay, A.** *A School for the Built Environment*, 2004 (BArch)

11. Related publications

- Architecture, June 2000, pg.122
- Architecture, July 2005
- Architectural Record, no. 7, 2003 pg.136
- Architectural Record, May 2005 pg.202
- Architecture South Africa, July/August 2004 pg 8 -17
- Domus, no.770, April 1995 pg.8
- RIBA Journal, September 2002, pg.56
- World Architecture, no. 103, February 2002 pg.52

12. Internet sites

- **Architecture Foundation** (London) 2005. *The New Architecture Foundation Building, London's new centre for architecture.* www.architecturefoundation.co.uk. (July 2007)
- **Rosco**, 1998. *Technotes. rear projection.* www.rosco.com/us/technotes/screens/technote_tbc.asp#rear (December 2007)
- **Durban Municipality**, 1998. *City Maps.* www.durban.gov.za (December 2007)
- **Google Earth**, 2007. www.googleearth.com (December 2007)

Appendix A: *Design Report*

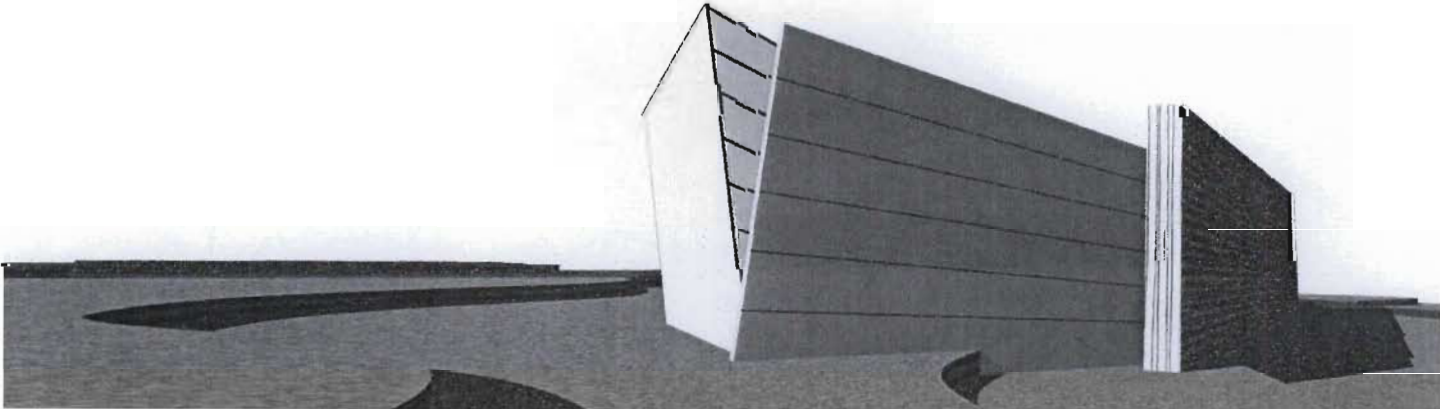

CONTENTS

- introduction	1
- project evaluation	2
- site evaluation	3
- design concepts	4
- conclusions	8
- accommodation schedule	9
- cross section illustrating the passive ventilation strategy	10

INTRODUCTION

There is a perception that design in sphere of the built environment is somewhat superfluous, and its significance in society is largely disregarded. The magnitude of the impact that our built environments have on our lives is not justly appreciated. A. Cortell, a noted historian, once said, "Tell me the landscape you grew up in, and I will tell you about yourself." Sir Winston Churchill adds this, by stating that "we shape our buildings, and they shape us."

Design in this sphere is far more than aesthetic whimsy. It is not reserve of the affluent either. It is the genius of the designer that dares to break from convention who can discover an extraordinary and innovative solution to the most mundane of problems. It is therefore the poorest that are most desperate for this skill, and as a developing nation it is essential that we embrace and nurture it.

It seems however that designers of the built environment are themselves largely responsible for reinforcing misconceptions. Their preoccupation with style and fashion leads them to neglect their greater responsibilities, and only encourages their exclusion from the decision making table.

Whether conscious of it or not, our built environment is the structural fabric within which we live our lives, and its shortcomings are our burdens. Society needs to recognise this fact, and establish a respect for design in this sphere.

These beliefs led to the idea of an Institute for the Built Environment for KwaZulu-Natal. An Institute with the objective of correcting misconceptions, promoting public interest, and essentially installing a demand for the creation and maintenance of quality built environments in the region.

PROJECT EVALUATION

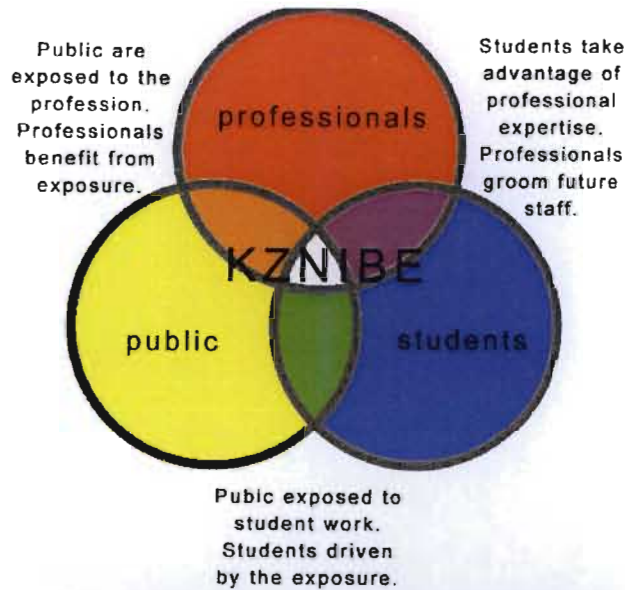

Essentially, the role of the Kwa-Zulu Natal Institute for the Built Environment would be to provide a centre of learning for the public, building industry, students and professionals, in order to improve the quality of our built environment. It would facilitate exchange and collaboration amongst members of the design, construction and real estate community through the organisation of events such as presentations, lectures, exhibitions and awards.

The KZNIBE would also play an important role in promoting an appreciation of Durban's existing architecture and urban fabric.

The concept of the KZNIBE developed into a building which accommodates three groups: the general public, professionals involved in the built environment, and students. The basic idea is that each group would benefit from an interaction with the other two.

The professional component is largely represented by the Kwa-Zulu Natal Institute for Architecture and its members. As the KZNIA's current premises at 106 Bulwer Road are no longer adequate for their growing needs, the institute would be accommodated in the KZNIBE building.

The student component is represented by students studying in the built environment fields at the University of Kwa-Zulu Natal and the Durban University of Technology, as well as those involved at the KZNIBE's school of advanced design, a two year post-graduate program.

The public component is open to all those interested in our built environment.

Although some areas of the KZNIBE are be strictly for the use of students and staff, much of the accommodation is used by all three groups at different times, or for events which involve everyone. This shared and frequent use of the KZNIBE's facilities greatly improves the feasibility



A packed architectural awards

of the scheme

SITE EVALUATION

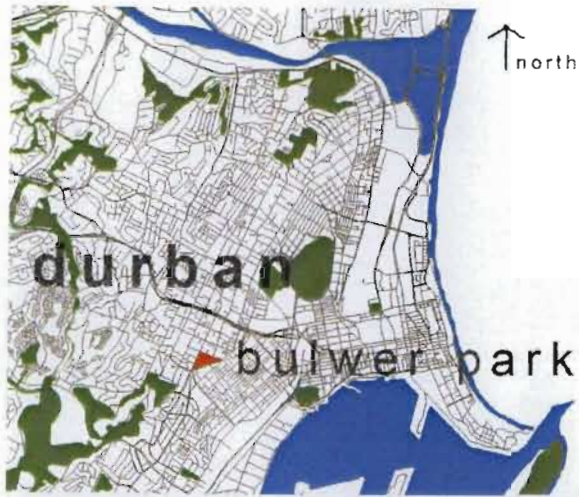

location map



an aerial photo of the site



a union period pavilion on the site

As Durban is KZN's largest city and its commercial centre, it was the most sensible location for the KZNIBE. Whilst the city has the KZNSA Gallery, the Bat Centre, Red Eye Art Gallery, and other venues which support the arts in general, there is no facility that acts specifically as a public window for architecture, landscape architecture, interior design and urban design.

Three of potential sites were examined, and after a comparative analysis a site at the bottom corner of Bulwer Park in Glenwood was selected.

The reasons for choosing the site were as follows:

- Great exposure – corner site at a major node
- Located in an existing, and further devolving cultural precinct
- Good urban infrastructure and close proximity to retail services
- Mixed use area consisting of a balance of both commercial and residential buildings
- On a public transport route
- Centrally positioned between, and in close proximity to both the UKZN and DUT campuses
- Site allows for good orientation and the environment is conducive to passive ventilation

The site however also presented challenges. One of those being that it contains three historically significant buildings which had to be designed around, and incorporated into the overall scheme

DESIGN CONCEPTS



an early illustration showing the impact the KZNIBE could have on the corner



conceptual model - seen from the intersection

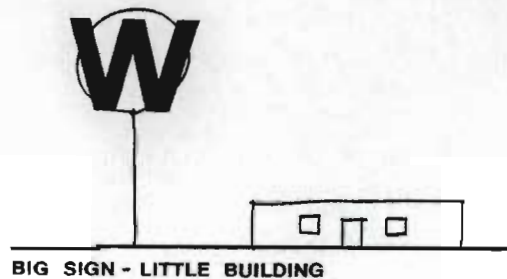

OR

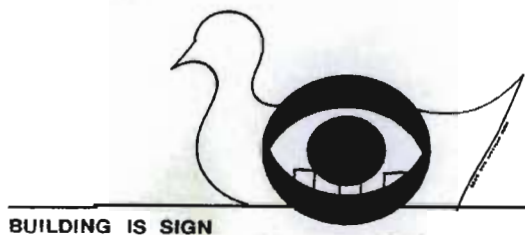

Billboard Concept: Site prominence and exposure is a key ingredient in the success of this type of building, and the KZNIBE needed to become a symbolic reference in Durban. This was critical, as need to generate public awareness is fundamental concern. For this reason a corner site at a prominent node was chosen, however, the building was still required to exploit its position.

The idea behind the 'billboard concept' is that instead of creating one street facing facade perpendicular to the street, one could create two street facades, each at a 45° angle to the road. The advantage of this decision is that the building's facades act like a freeway billboard, capturing attention from traffic in both directions, as they connect powerfully with the street. Whilst one façade faces traffic approaching from the south-west along Bulwer road, the other faces the intersection of Bulwer and Davenport roads directly. Like Paul Rudolf's School of Art and Architecture, the corner between the two facades projects out towards the pavement and commands a powerful presence.

As Robert Venturi argues in 'Learning from Los Vegas', unlike many modern buildings, the architecture of a structure alone, should be able to generate a powerful symbol... thus communicating for itself, rather than resorting to other devices such as a large sign intended to catch attention and point to a symbolically ineffective building.

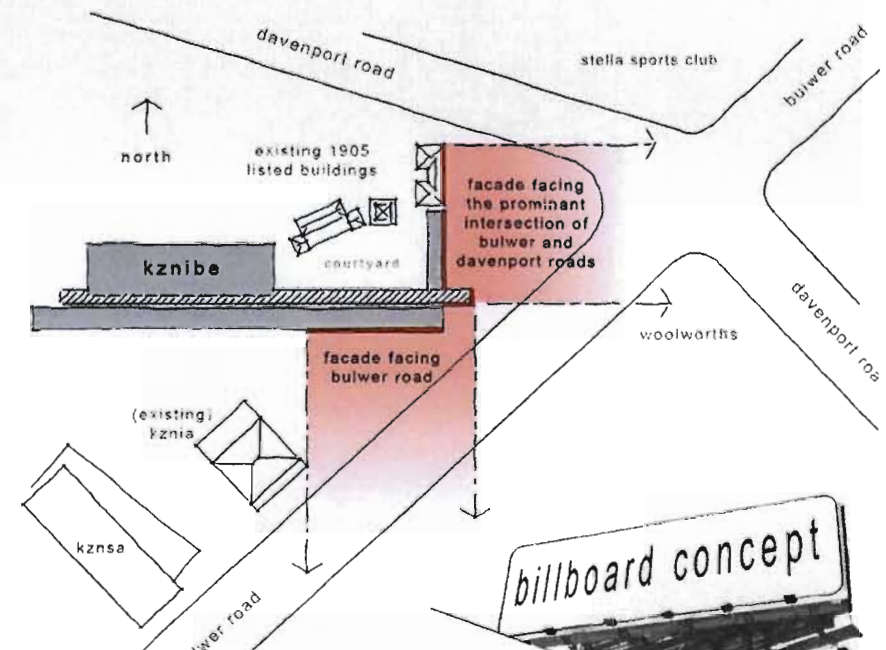

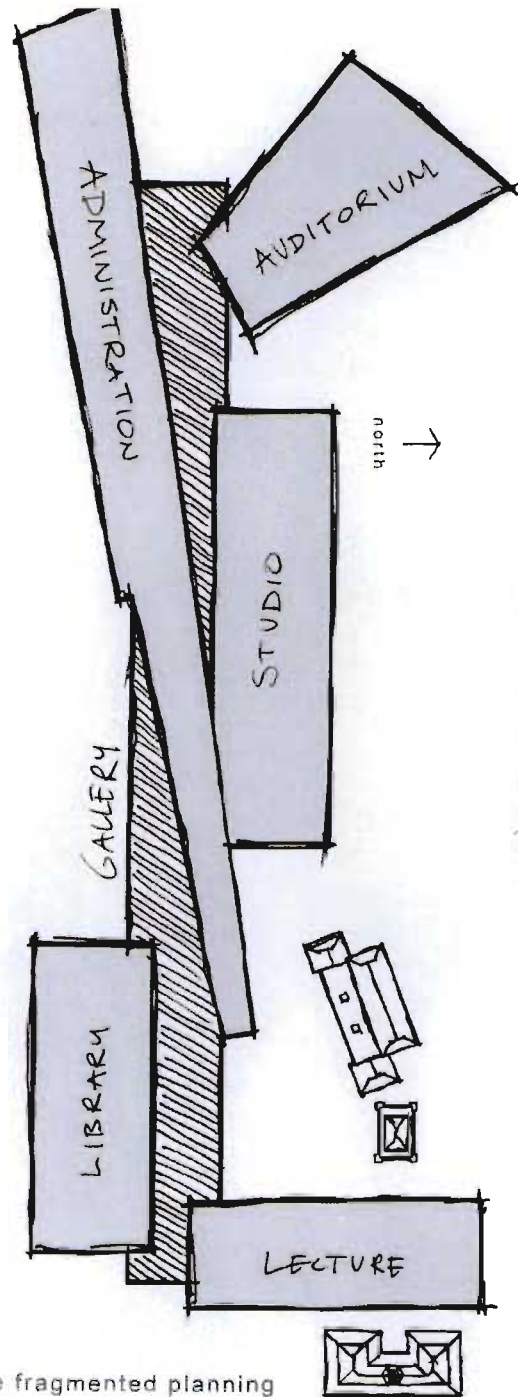

the fragmented planning of the KZNIBE



The south west perspective demonstrates how the administration and the library components are their own entities, and clearly distinguishable in the overall form.

Fragmented Form: The overall form, or massing, of the KZNIBE clearly communicates its various functions. Rather than creating a building with a single unanimous form, thus compromising the spatial needs of each of the institute's unique components by restricting them to conform to the boundaries of a uniform floor plan outline and limiting spatial arrangement to vertical displacement, a more function responsive and spatially experiential solution was created.

Each component of the KZNIBE was designed separately, thus generating its own form specific to its unique function. These various forms were then arranged according to the requirements of the program to generate the overall form of the building. The completed massing thus maintains the legibility of each component in the institute, which facilitates orientation and an effortless understanding of how the building works.

DESIGN CONCEPTS

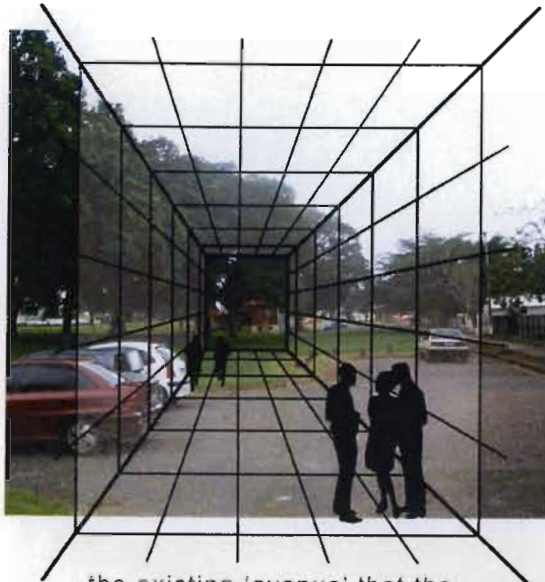

the existing 'avenue' that the central spine occupies

Central Spine: According to Dieter Holm, buildings in this region should be free-standing to allow air movement through. Narrow plan shapes with a single row of rooms are preferable, because they allow cross ventilation. For good solar orientation, the North and South sides of the building should be the longest. (Holm, D. *Manual for Energy Conscious Design*. 1996:52)

For these reasons a central spine was created that lies along an east-west axis, the other components of the KZNIBE were then attached to its sides, either facing either north or south.

The spine not only acts as a central circulation corridor, but is also the gallery or exhibition space. The thought behind this decision was that instead of the gallery being a destination... an isolated space in the corner, rather it should be a journey, experienced as one uses the building.

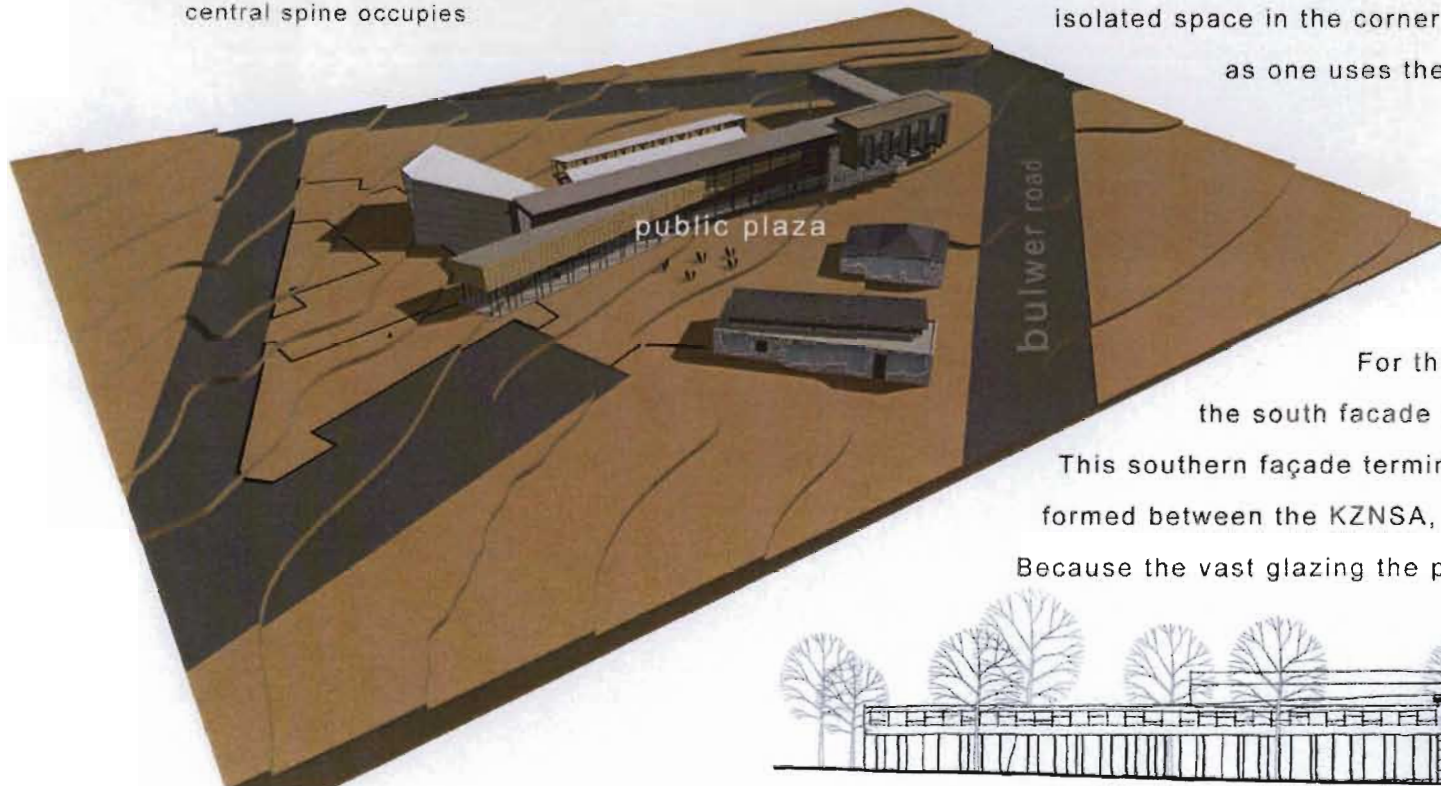

As the gallery is also the most public component of the KZNIBE, it was thought that it should have a strong connection with the outside environment.

For this reason, and to exploit indirect sun-light, the south facade of the gallery is almost completely glazed.

This southern facade terminates the top edge of a public plaza that is formed between the KZNSA, 106 Bulwer Bulwer Road and the KZNIBE. Because the vast glazing the plaza and the gallery share a single space.

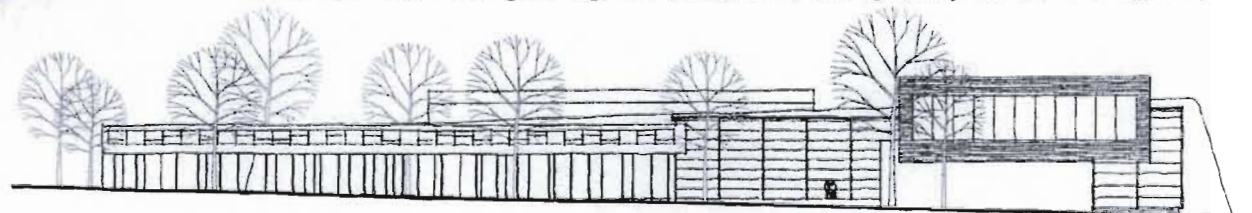

DESIGN CONCEPTS

Public and Private Spaces: The design process of the KZNIBE had to acknowledge the duality a building which has both public and private spaces. As a result the spatial arrangement of the various components was designed to maintain a legible privacy gradient. This privacy gradient, a clear progression from public to private spaces, was created to improve privacy and security in the student and staff areas, as well as to facilitate an ease of movement along logical circulation routes.

Thus the most public components, the auditorium, gallery, lecture room and snack-bar, are all situated on the ground floor, whilst the library and student and staff areas are elevated to first floor and above.

The layout and position of the building also defines two external spaces. The first, the is the public plaza formed between the KZNSA, 106 Bulwer Bulwer Road and the KZNIBE, is large and very public space. The second is a small courtyard formed between two of the existing municipal structures on the site, and the KZNIBE which encloses the space on the south and west. In contrast to the large plaza opposite the gallery, this courtyard, whilst still public, is a far more intimate space. It contains a snack-bar in the larger of the existing structures, and would act as a catering venue for events at the KZNIBE.



● internal courtyard ● public palza

below: a view of the plaza from the space between the KZNSA and 106 Bulwer Road



CONCLUSIONS

The design brief for a building like the KZNIBE is especially intimidating. The design comes under extraordinary scrutiny as it is generally accepted that the building needs to set a benchmark for architecture in the region, whilst still meeting its function with the most appropriate design solution. As a result, the architect is under tremendous pressure to excel in every possible criteria: environmental considerations, social considerations, form, architectural language, choice of materials, style, etc. Every decision goes under the magnifying glass.

For these reasons the designs of buildings of this sort are often selected from competitions, so that a panel may select an exceptional design, which once built is usually the subject of much debate. Two such examples are the Netherlands Architecture Institute building in Rotterdam, and more recently the Architecture Foundation building in London, due to be completed late 2008.

Ultimately though, a building is required to perform a function, just as any other. As the architect one can only do ones best to consider every angle, critically judge every decision as best one can, and confidently go with it.

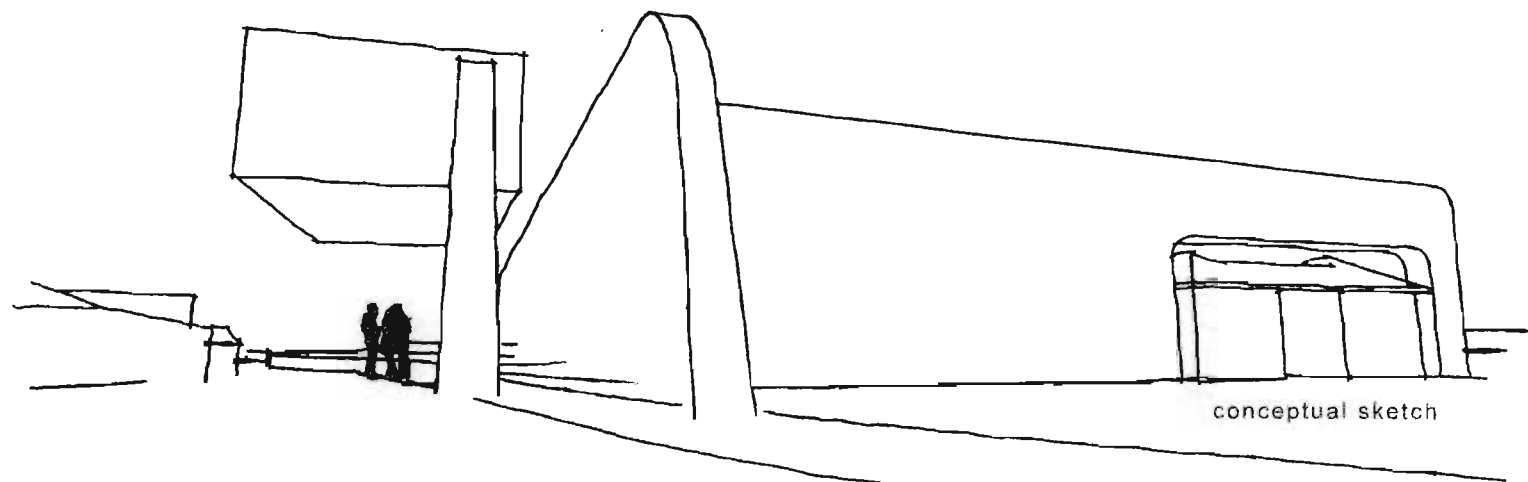

ACCOMMODATION SCHEDULE

NAME	SIZE	LINKED TO	PUBLIC / PRIVATE
Exhibition space	450 m ²	catering facility, (entrance)	public
Exhibit prop store room	100 m ²	exhibition space, (service gate)	private
Workshop	150 m ²	exhibit prop store room, (service gate)	private
Auditorium	200 p	catering facility, (entrance)	public
Rear projection room	-	auditorium	private
Catering space	200 p	auditorium, exhibition space, (entrance)	public
Snack-bar (behind counter)	20 m ²	Catering space, cold store, (service gate)	private
Cold store room	10 m ²	Snack-bar, (service gate)	private
Library	-	studio, administration, (entrance)	public
Issue desk	15 m ²	library entrance, book stacks	
Book stacks + archives	120 m ²	issue desk	
Reading area	60 m ²	book stacks + archives	
Reading lounge	40 m ²	periodical shelves	

Administration	-	studio, library	private
KZNIBE administration	30 m ²	front of admin, board room	
Board room	30 m ²	front of admin	
School staff	140 m ²	board room	
Staff kitchen	20 m ²	staff lounge + dining, board room	
Staff lounge + dining	60 m ²	staff kitchen	
Studio	320 m ²	Library, lecture hall, seminar room, CAD teaching room, administration	private
Meeting area	60 m ²	studio, student kitchen	
Student lounge	40 m ²	studio	
Student kitchen	30 m ²	studio, meeting area	
Building Yard	40 m ²	(service gate)	
Lecture hall	50 p	Studio, (entrance)	public
Seminar room	40 p	Studio, (entrance)	public
CAD teaching room	40 p	Studio, (entrance)	public
Toilets	-	separate facilities for public, staff and students	-
Cleaners store	10 m ²	(centrally positioned)	-

CROSS SECTION ILLUSTRATING THE PASSIVE VENTILATION STRATEGY

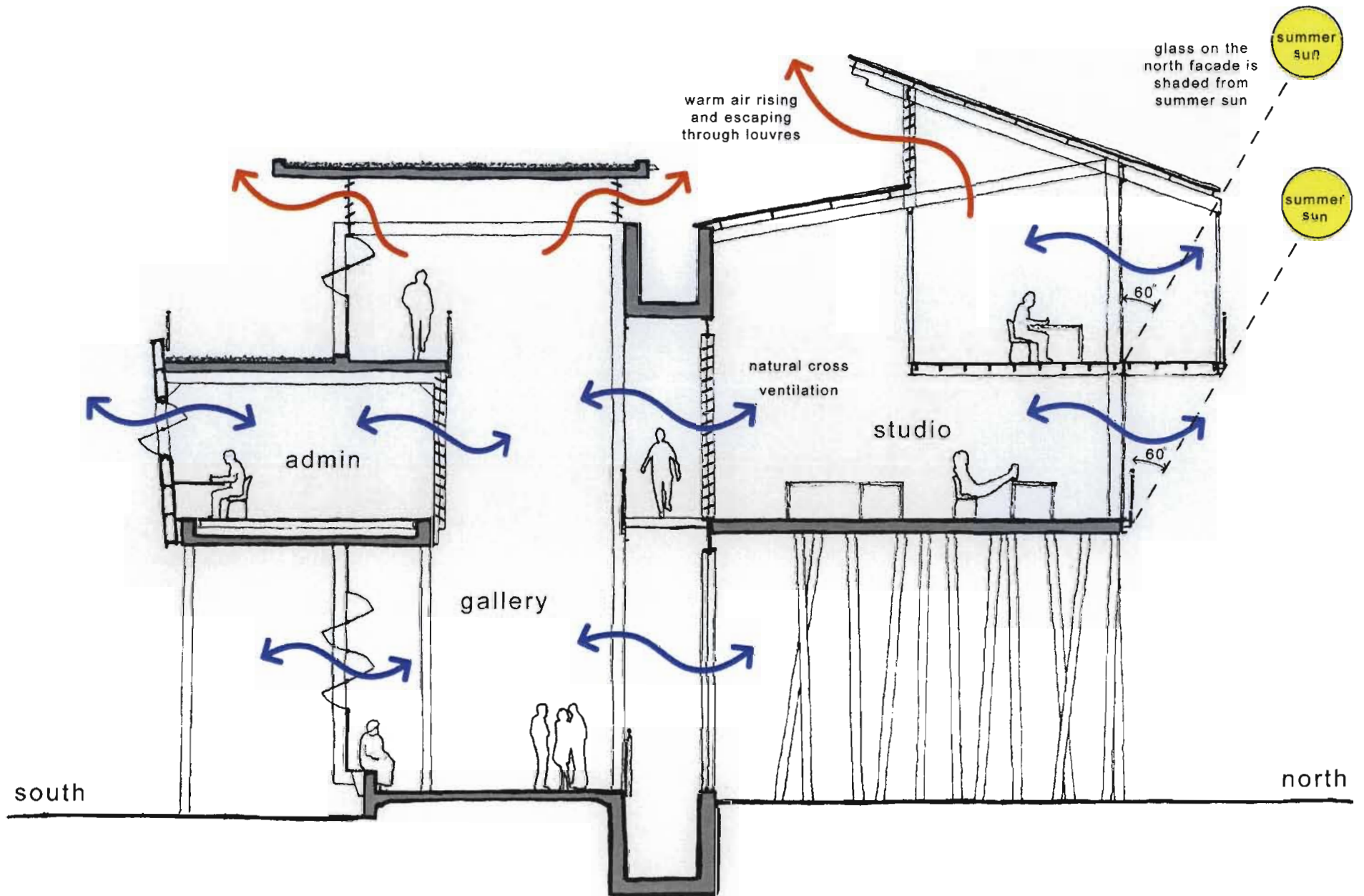

Appendix B: *Design Presentation*



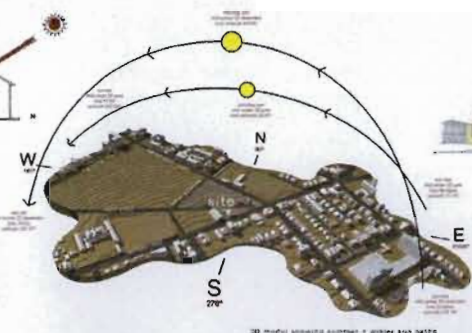
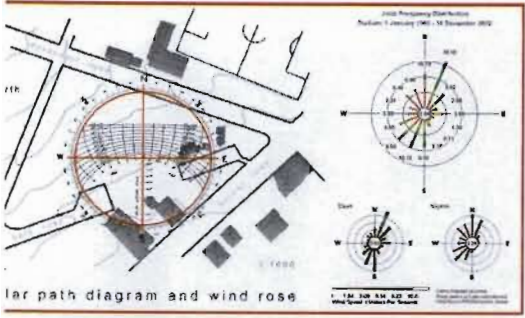
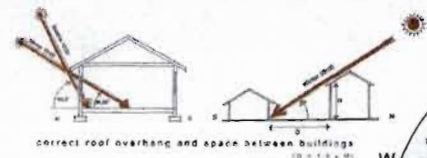
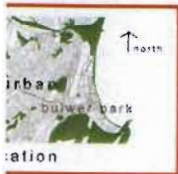

Davenport Road 'woolworths node' elevation



typical road cross section (Davenport Road)



main vehicle routes



main pedestrian routes



figure ground 1:2000
contours @ 2m



3D model of site and surrounding buildings

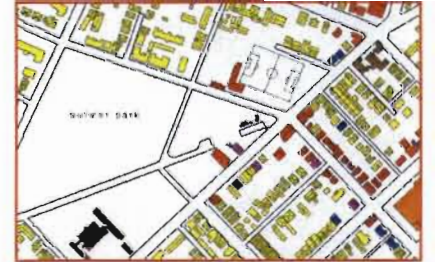

building use survey

- residential building
- commercial building
- retail building
- high commercial building
- points of interest / works
- mixed use building





conceptual perspectives

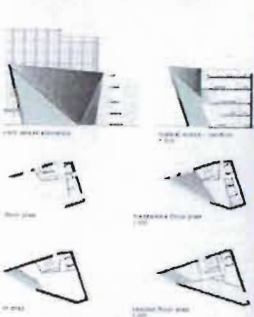

aerial perspective



precedent study
NEW ARCHITECTURE CENTRE FOR LONDON
Zaha Hadid 2008



perspective from south west

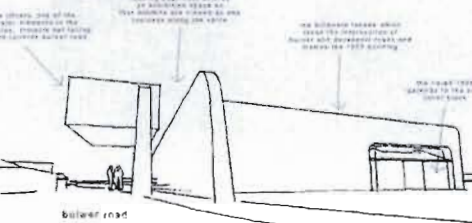
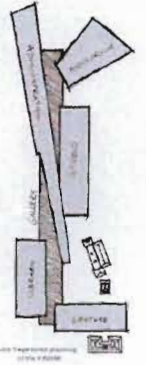

framing the pavilion
"when you frame something, you capture it's value"

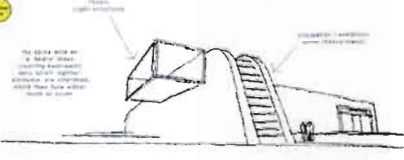
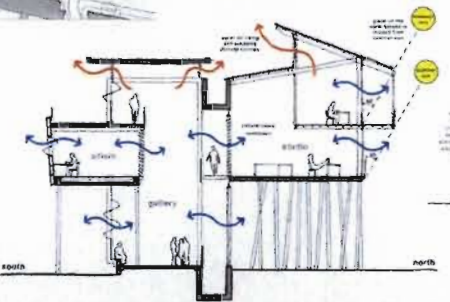
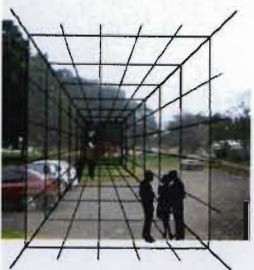

corner concept sketch
illustrating the impact on the corner of Bulwer and Davenport roads

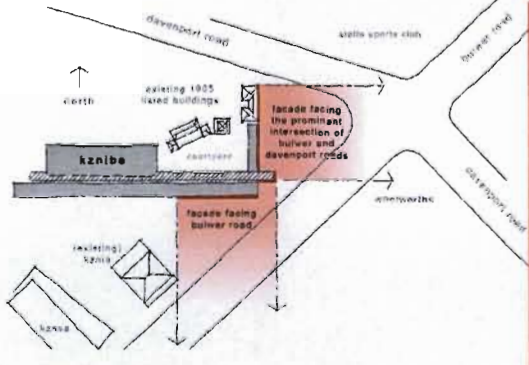

existing site

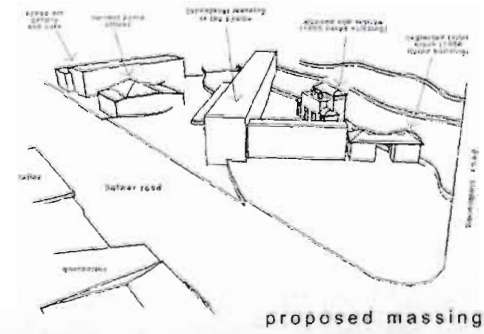
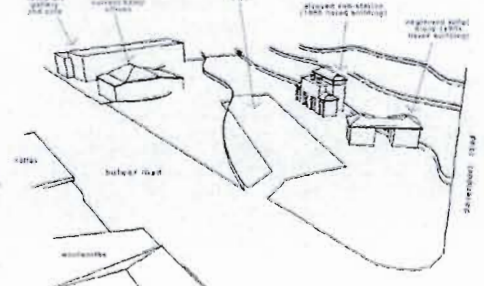

proposed massing

L-shaped massing > creates courtyard between existing 1905 buildings

facades are angled to maximize exposure >

encourage movement along the gallery / circulation spine by placing the auditorium and courtyard at opposite ends

attach elements on opposite side of the spine facing north and south

retaining & anchoring pedestrian routes > define the site

establishing the optimum position of the entrance

orth

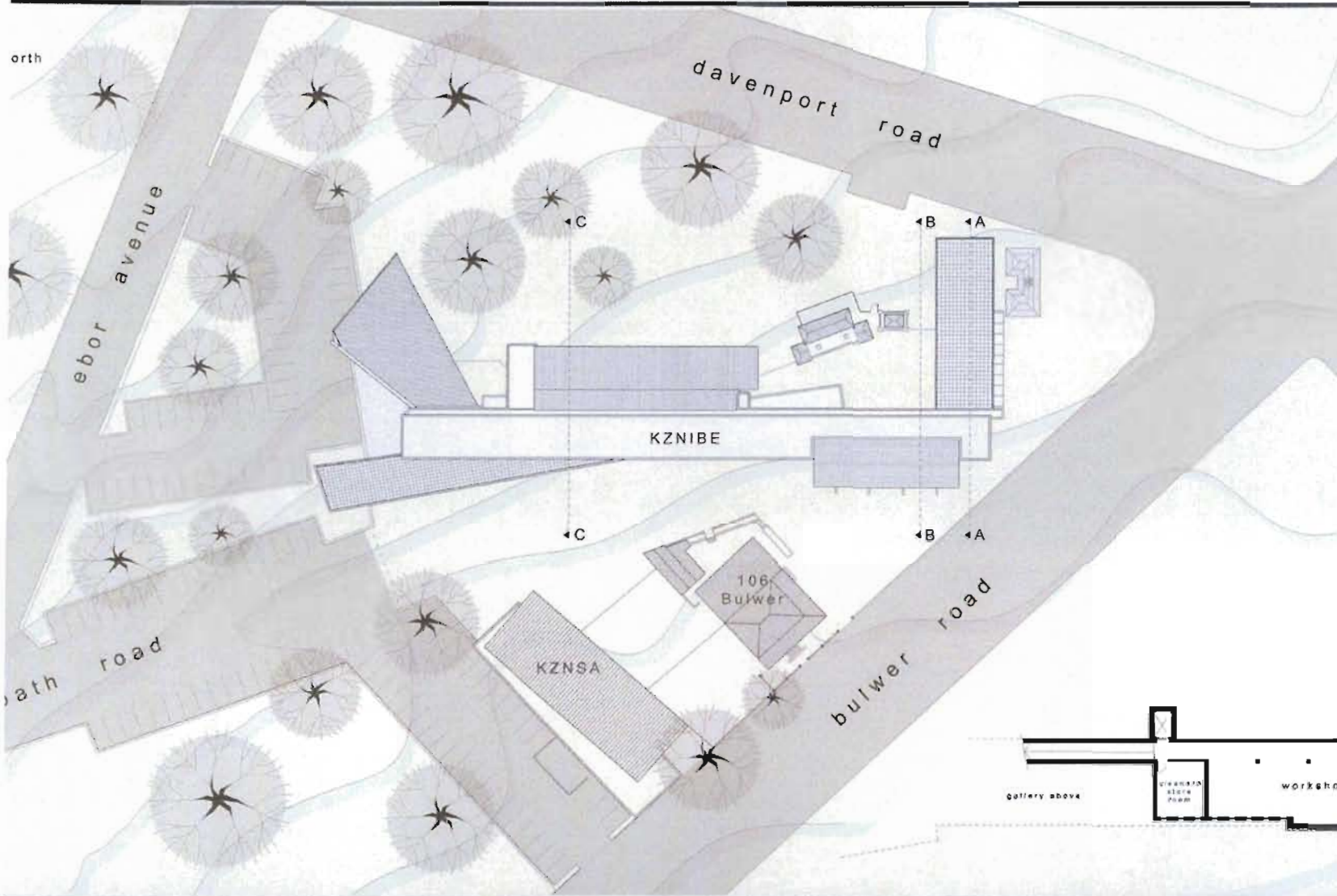

< site plan
1:200

basement plan
1:400
v



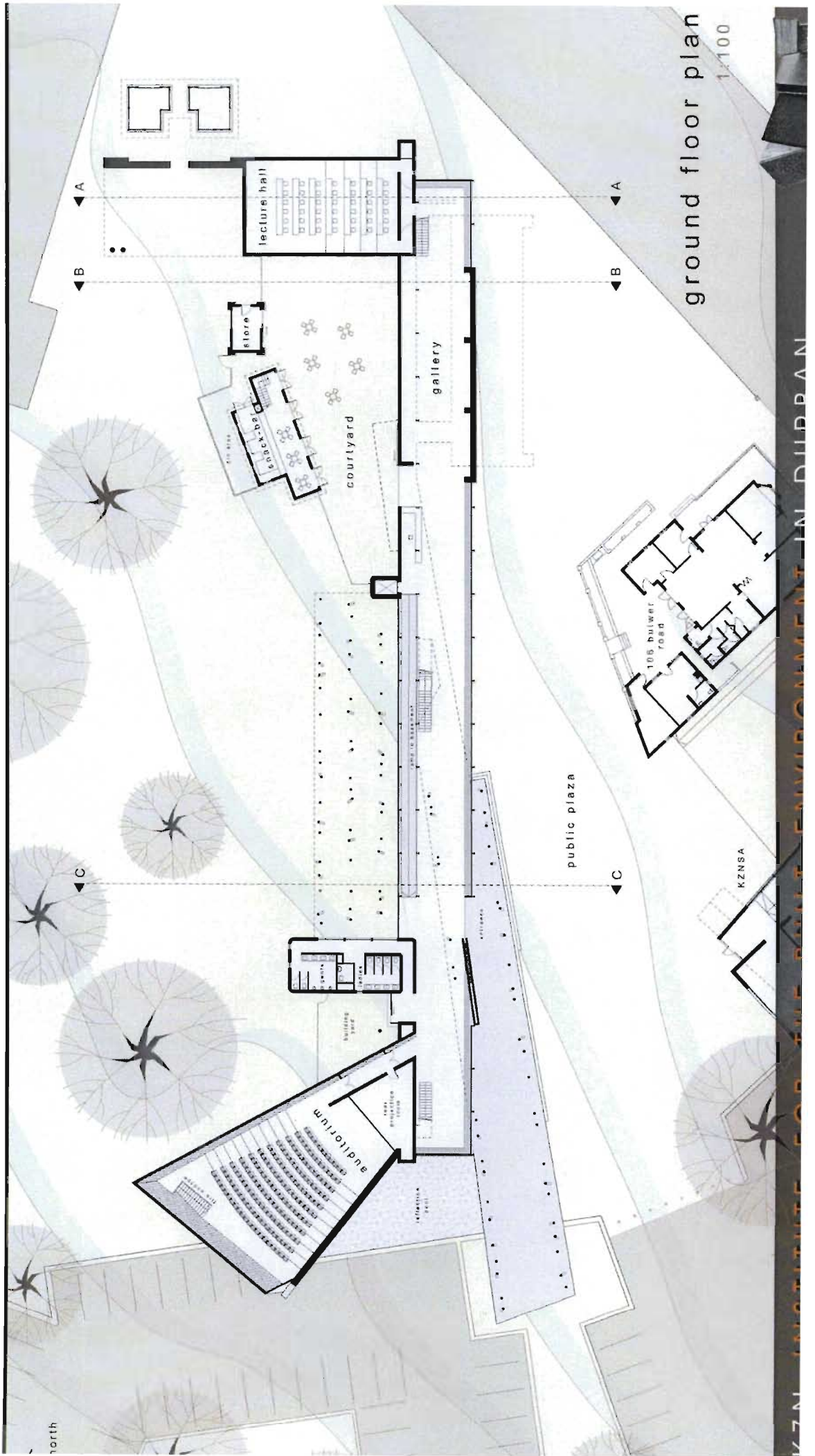

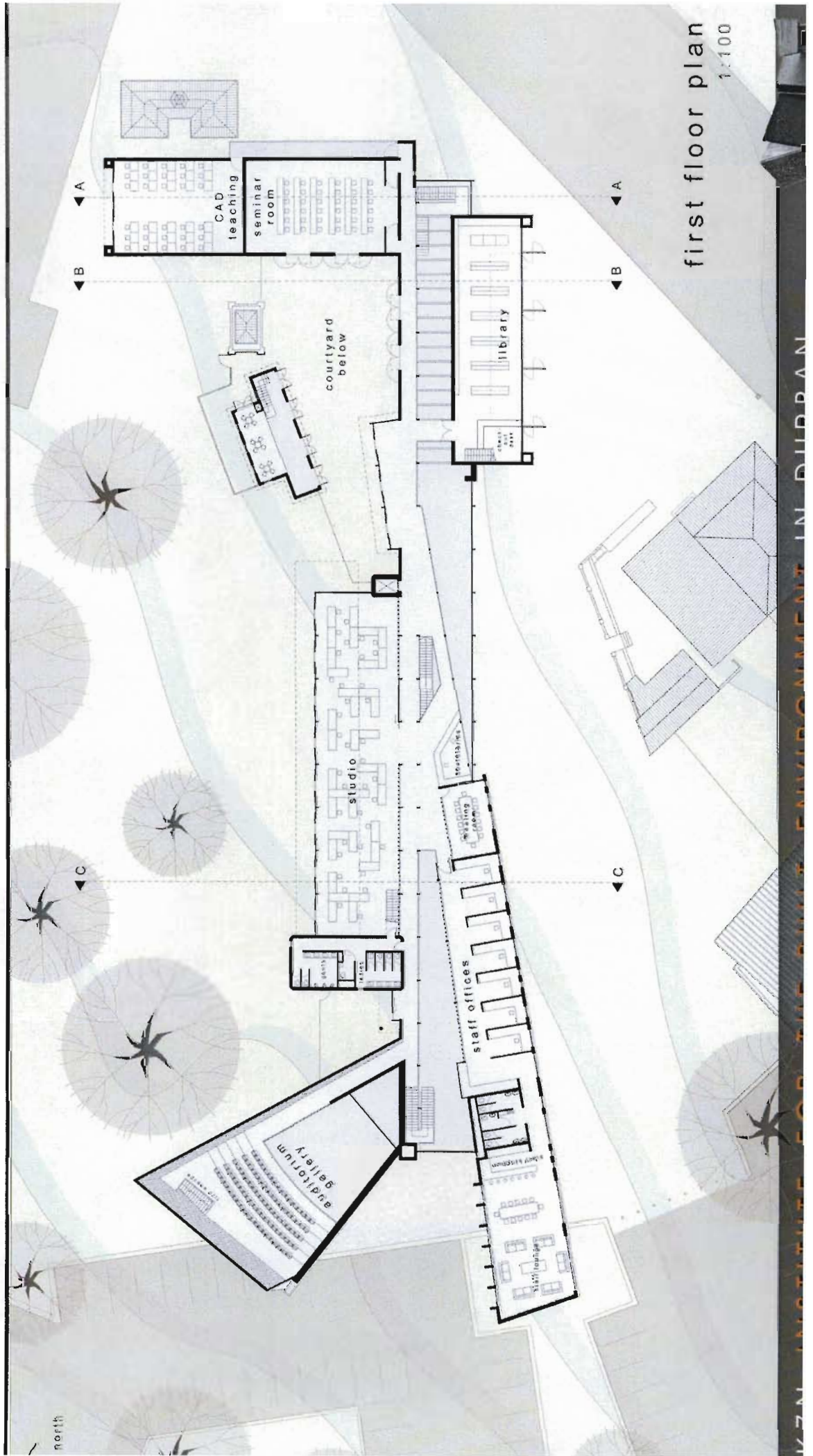

first floor plan
1:100

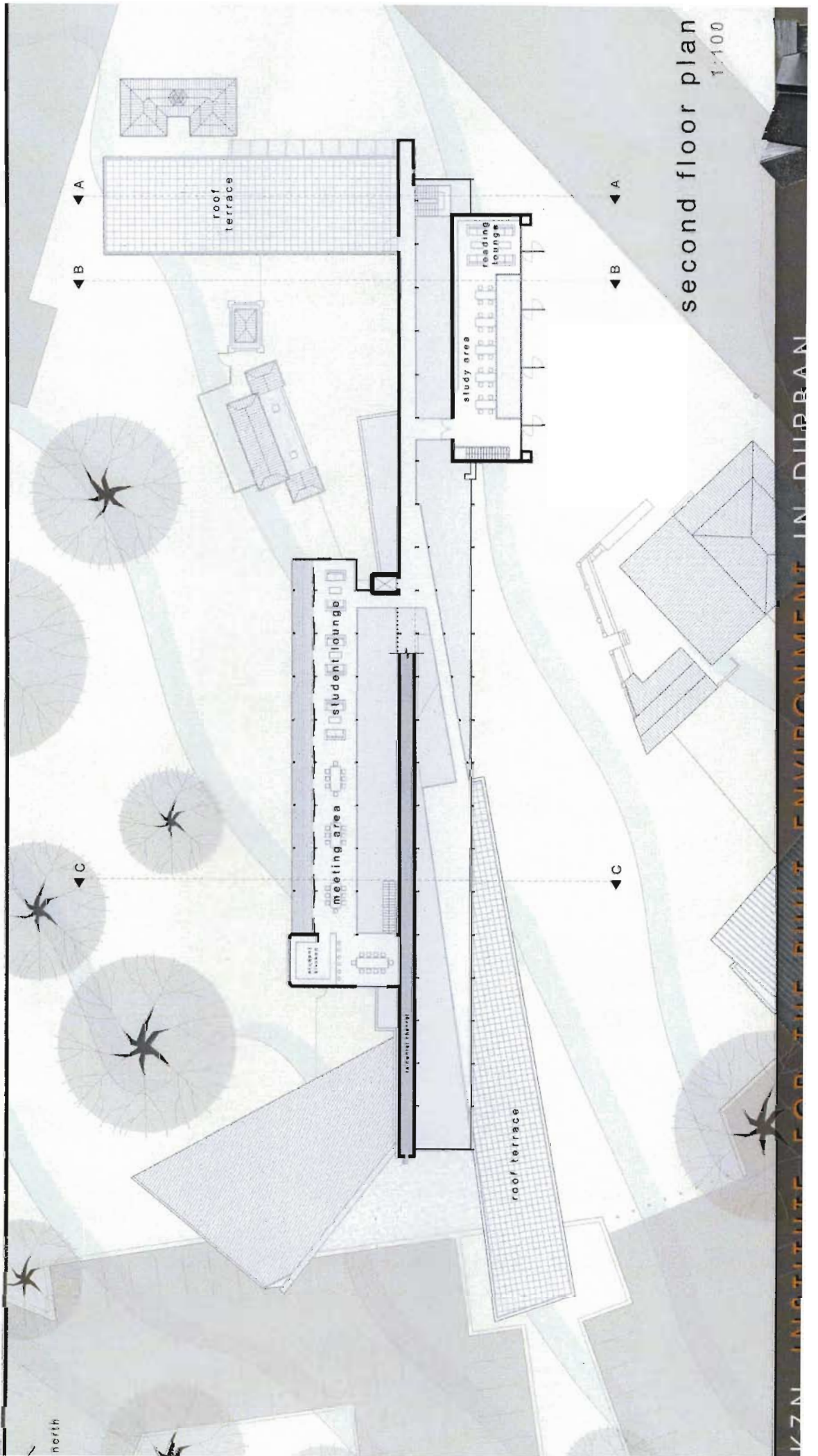

second floor plan
1:100

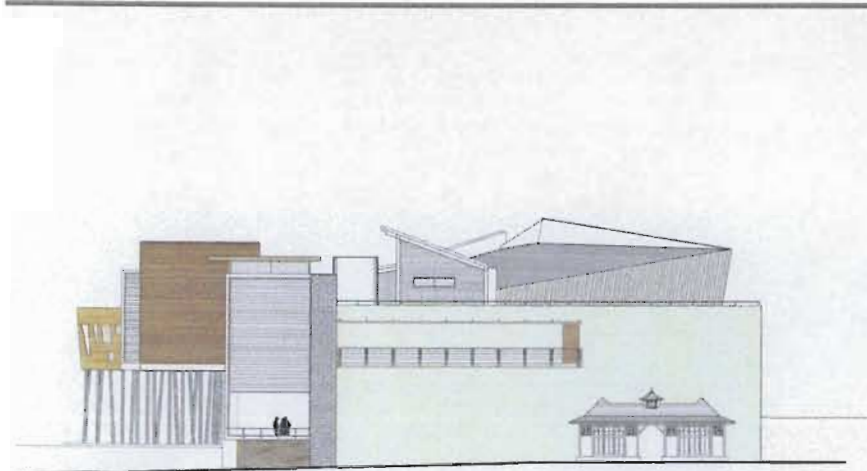

east elevation

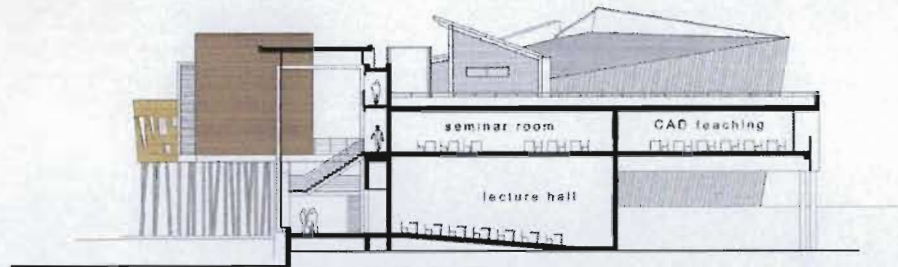

section a-a

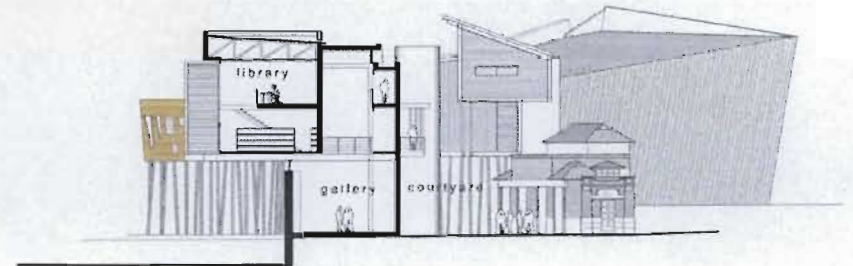

section b-b

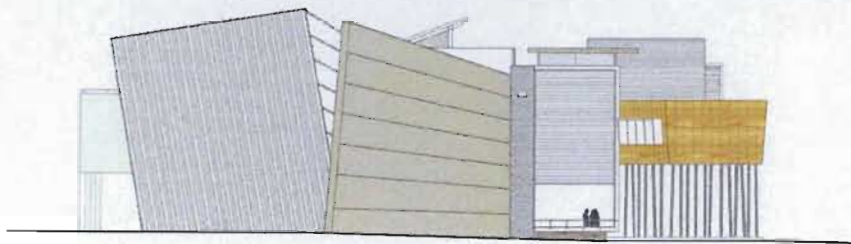

west elevation

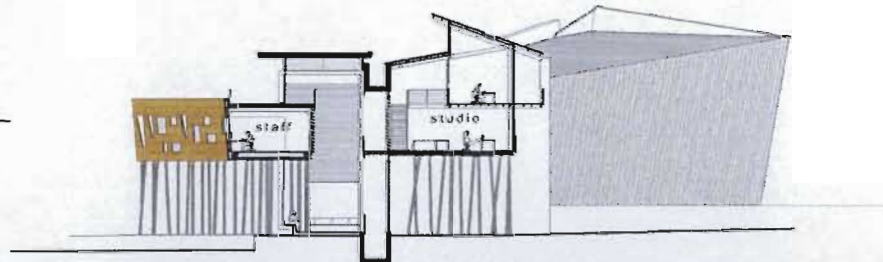

section c-c

sections +
elevations

1:100

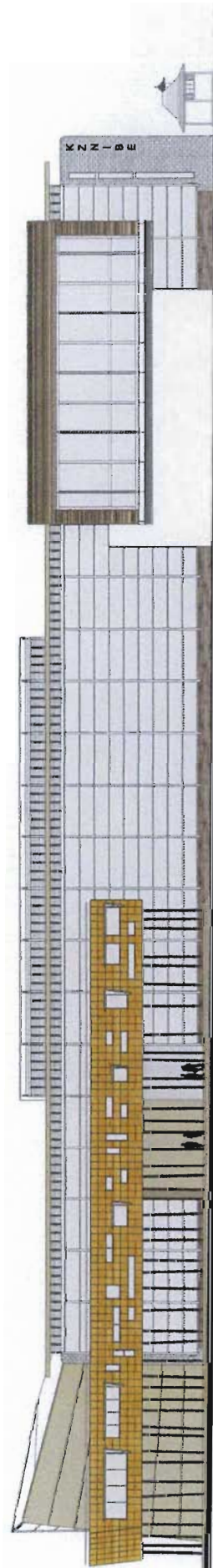

south elevation
1:100



north elevation
1:100

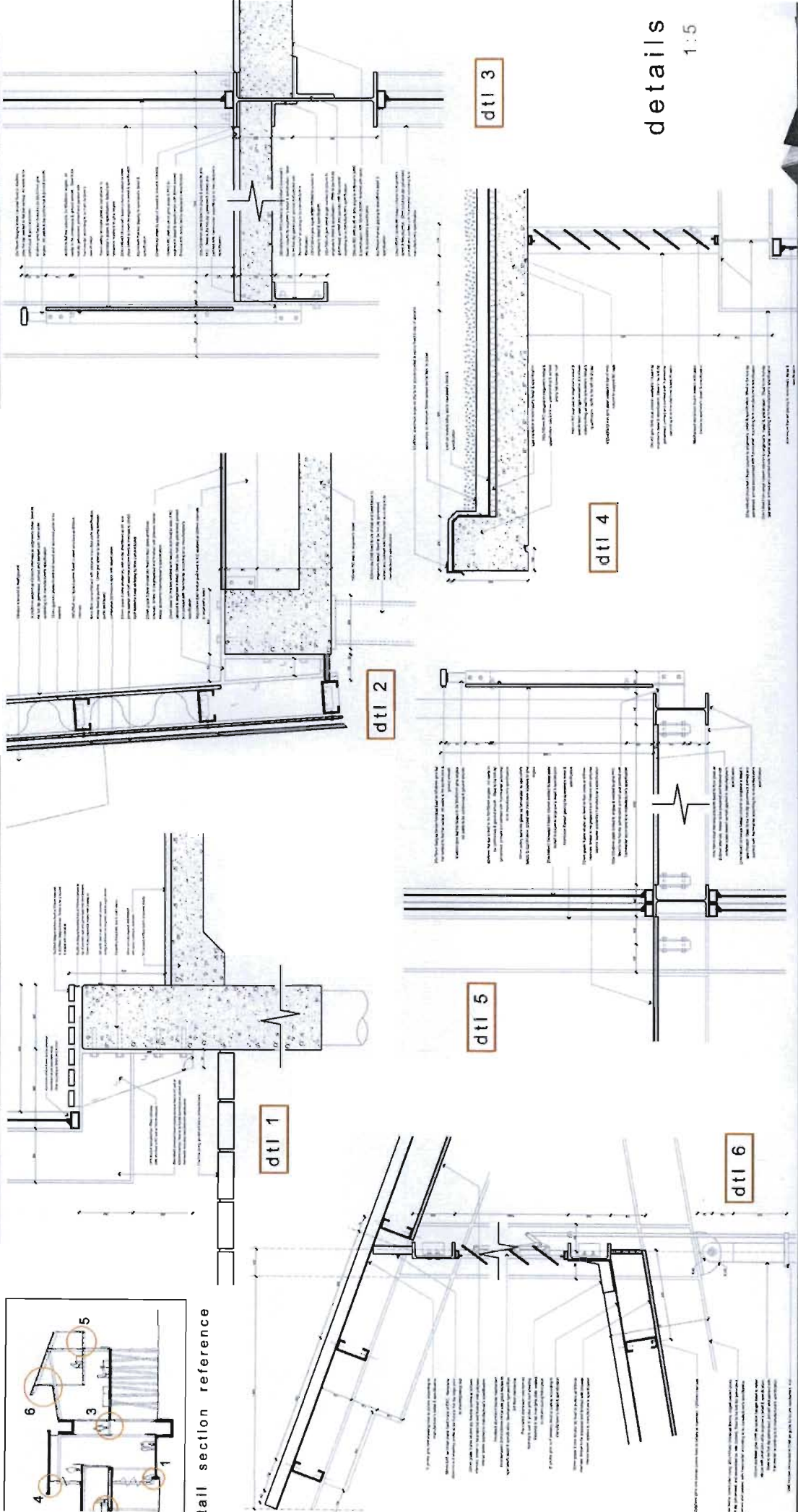

details
1:5