

SOME ASPECTS OF THE DYNAMIC PROCESS OF CREATIVITY WITH SPECIAL  
REFERENCE TO THE CHOREOGRAPHER AND DIRECTOR IN THE THEATRE

---

F. Hagemann



A Thesis submitted by Fredrick Hagemann in partial fulfilment  
of the requirements for the Degree of Doctor of Philosophy in  
the Department of Speech and Drama at the University of Natal.

1979

LIST OF CONTENTS:

INTRODUCTION.

PAGE 1.

PART ONE

THE ACT CONCEPT

CHAPTER ONE:  
THE PROBLEMS OF DISCURSIVE LANGUAGE IN  
DESCRIBING MOVEMENT.

PAGE 7.

CHAPTER TWO:  
THE BIOLOGICAL MODEL OF THE ACT.

PAGE 34.

CHAPTER THREE:  
THE ACT CONCEPT IN RELATION TO MAN .

PAGE 50.

CHAPTER FOUR:  
THE APPLICATION OF THE ACT CONCEPT  
TO HUMAN MOVEMENT.

PAGE 66.

PART TWO

THE ACT CONCEPT IN RELATION TO  
THE CREATIVITY OF THE CHOREOGRAPHER

CHAPTER FIVE:  
A DESCRIPTION OF CREATIVITY  
IN MOVEMENT TERMS.

PAGE 80.

CHAPTER SIX:  
ACTS AND SUB-ACTS IN DANCE.

PAGE 96.

CHAPTER SEVEN:  
SYMBOLIC PROJECTION OF  
CREATED ACTS IN DANCE.

PAGE 121.

PART THREE

THE ACT CONCEPT IN RELATION TO  
THE CREATIVITY OF THE DIRECTOR.

CHAPTER EIGHT:  
THE NATURE OF DRAMATIC ACTS IN  
PERFORMANCE.

PAGE 141.

CHAPTER NINE:  
THE PROJECTION OF THE TRAGIC VISION.

PAGE 55.

CHAPTER TEN:  
CONCLUSION

PAGE 175.

BIBLIOGRAPHY.

PAGE 182.

## INTRODUCTION

The dynamic process of creativity belongs to the phenomenal field of action. Some acts lie below the level of sensual cognition, while others are directly evident to the senses. In terms of art a process may be defined as the spatio-temporal means by which the artist effects a projection. The activity and the spatio-temporal means, which is an abstraction of quality and form from the total activity, are observable. Through an investigation of these observable phenomena, in terms of structural relationship and functions, the principle of the artist's projective activities may be comprehended. The principle of artistic projection will be defined within the context of the artist's creative processes accomplished in theatre. Susanne Langer's concept of a projection, which she defines as 'something that extends in one direction beyond the general smooth contours of a mass'<sup>1</sup>, will be applied to art in a metaphorical sense in that it denotes a principle of presentation. A work of art, which is the projection, evolves from the subjective internality of the artist; it is an external form of objectified feeling and therefore an analysis of this projected form in terms of its rhythmic tensions, structure and extended symbolic nature will provide an insight into the artist's process of creation.

The artist's purpose is not primarily to communicate, it is to formulate. It is only by virtue of the objectification of feeling and subsequently its formulation that art becomes communicable. It is important to realise that what is communicated in all art is not natural subjective feeling but the objectified form of feeling. Thus art has no

---

1. S.K. Langer, Mind: An Essay on Human Feeling, Vol. 1, p.74.

direct vocabulary of feeling as language has a direct vocabulary of discussion. Each process of artistic projection is created in terms of its individual dialectical nature. The feeling, idea or whatever it be that is projected by the artist, once objectified, demands a renewed subjective response from the artist. This is made possible by the structured dynamics of the work of art in the making. Structured dynamics are ways in which element (visual shape, colour, audible or felt rhythms) achieve tensions and harmony.

In following the process of artistic projection the problem of subjective/objective dualism becomes a prime concern. Artistic projection is a principle of presentation.<sup>2</sup> That which is presented by the artist in a work is not the feeling itself nor does the work of art contain feeling. The semblance of feeling in art is totally different from direct feelings recognised in the body. The impulse of creativity, which may be a feeling in the artist, is different from the impact the work of art has on the artist during its creation and the 'vital import'<sup>3</sup> of the work on the spectator. The incompatibility between the physical ingredients of the art, which in the case of the art of the choreographer is primarily the dancer and in the art of the director, the actor, and the presentational import of the work, that is the dance or the play, is basically an issue of man's ability to view himself as both subject and object.

Soren Kierkegaard has written :

For an objective reflection, the truth becomes an object, something objective, and thought must be pointed away from the subject. For a subjective reflection, the truth becomes a matter of appropriation of inwardness, of subjectivity, and thought must probe more and more deeply into the subject and his subjectivity.<sup>4</sup>

- 
2. S.K. Langer, Feeling and Form, pp. 69-83 (See Chapter Five).
  3. Ibid.
  4. Kierkegaard, Concluding Unscientific Postscript, translated by D.F. Swenson and M. Loomis.

The first mode of reflection has led to the supposed objectivity of the scientific approach, the second mode to the investigation of man's psychology. Unfortunately scientific objectivity, which stems from Galileo's mathematisation of nature, has led many psychologists and in particular Behaviourists to expel from their consideration all the vocabulary used for subject introspection.<sup>4</sup> Any attempt to analyse contextual meaning empirically is a confusion between the two modes of reflection stated above.

Simone de Beauvoir, following Sartre's concepts as stated in Being and Nothingness, has written in The Ethics of Ambiguity :

At every moment (man) can grasp the non-temporal truth of his existence. But between the past which no longer is and the future which is not yet, this moment when he exists is nothing.<sup>5</sup>

This quotation sets out the problem of the mind's inability to grasp the sheer fluidity of the moment save as a relatively static concept. Thus there appears to be two separate states, that of 'Being' and that of 'Knowing'. The difference between the mental model or concept of the moment and that of the felt reality of the moment is that of flux.

It seems to be impossible to capture the nature of flux as a spatio-temporal concept. For example, each moment may be designated by a number. Between moment 'one', moment 'two', moment 'three' and so on, there are other possible moments, namely those designated by 'a half', 'a quarter', 'an eighth', 'a sixteenth' and so on. The number of moments between any two moments is indefinitely large. In the same way, flux may be thought of as lying against a spatio-temporal background in which, in between every moment of change, there are an indefinite number of changes.

---

4. Discussed in The Crises of European Sciences and Transcendental Phenomenology, translated by David Carr, p.48.

5. Simone de Beauvoir : The Ethics of Ambiguity, p.27. (Brackets are mine).

Because of the indefinitely large number of possible points which the mind is able to distinguish between, flux, as a consecutive, additional process of time in space, must be rejected as being conceptually impossible. At this level, existence in the moment remains a negativity. However, the positive affirmation of existence is justified as an experience of itself and for itself.

Existence asserts itself as an absolute which must seek its justification within itself and not suppress itself, even though it may be lost by preserving itself. To attain this truth, man must not dispel the ambiguity of his being but, on the contrary, accept the task of realising it. He rejoins himself only to remain at a distance from himself.<sup>6</sup>

If man agrees to remain distanced from the self, the concept formed in the mind will always be separated from experience in action. The flow of change from 1 to  $1 \frac{1}{x}$  (where x is an indefinitely large number) may only be felt in the pure fluidity of the progression of movement in which space and time become internalised.

The aim of this thesis is to develop an approach to the understanding of 'feeling' as an activity of projection through movement whereby man is able to formulate his experience of his inner life. The problem of the ambiguity of feeling and thought has had much attention given to it by philosophers. The approach of the Phenomenologists has pointed towards the inseparability of existence and knowledge of existence. This is demonstrated in Heidegger's phrase 'Being-in-the-world', by which is meant that man has not merely a position in the world but that he is concerned with the world in his existence. To say of man that he has 'Being-in-the-world' is to point to an existential relationship between man and the world, rather than a spatial relationship. The Phenomenology

---

6. Simone de Beauvoir, The Ethics of Ambiguity, p.13.

of Heidegger has shown that man may become an object for himself but that in the very act of objectification he is capable of realising that his objectified being has a relationship with the self, his subjectivity.

This is simply stated by J.N. Findlay :

... for the relationship of inner states of feeling, sensation thought, attitude, and so forth to outward situations and actions is not, and cannot be, that of two disparate things empirically associated. The one represents the dispersion into separateness, it being intrinsically likely, *ceteris parabis*, that the former will issue in the latter and vice versa. No one who trains his 'seeing eye' on his own condensed moods of feeling and thought on the one hand, and their explication in behaviour or objective situation on the other can doubt that we have here a connection of essence, if only an intrinsically likely connection. The one completes and fits the other.<sup>7</sup>

It will be shown that this essence is the dynamic aspect of movement, which may be understood through the concepts of 'acts'. It will be necessary to discuss movement as 'acts' on two levels. Firstly on the molecular and cellular level in order to reveal the nature of organic growth and development and secondly on the level of the organism as a whole. The second category includes man as a social, anthropological, creative, symbol-making individual. The two levels of approach to 'acts' will be based on the concept of, what may be said to constitute, an individual. At each level the individual will be redefined in order that the projection from the individual may be seen as a projection. On the biological level individuation may be synonymous with organism, although even at this level the difference between an organism and an individual may be argued. For example, microbiologists do not regard viruses as organisms since they cannot grow except in living cells. This categorisation is based on function. On the other hand it may be argued from the point of

---

7. J.N. Findlay, Phenomenology in America, p.106.

view of the Structuralists, that, since the structure of many viruses have been ascertained through the use of the electron microscope, it is reasonable to say that their structural peculiarities constitute their individuation. For example, the iridescent virus and the adenovirus have the structure of a regular icosahedron.

In Chapter 1 the problems of using discursive language to describe the individual and the relationship of the individual to his action will be discussed. Later, creativity will be discussed in terms of evolutionary activities that have allowed for the development of mind from which artistic projection emerges. Finally, attention will be focused on those factors which are essential to man's ability to objectify feeling in an external form through the use of his projective ability.



PART ONE

THE CONCEPT OF ACTS

THE PROBLEMS OF DISCURSIVE LANGUAGE IN  
DESCRIBING MOVEMENT.

Words do not have a one to one relationship with their meaning, nor with the objects in the external world which they denote. There are many words, such as 'yes', 'no', 'love' and 'hate' that have no 'is' meaning. That is, we may not say 'Yes is ...' or 'love is ...' or 'emotion is ...'. By using language additively one gives words fixed values. In these circumstances language only has meaning in additional absolutistic, one-valued statements. However, 'yes' may have an indefinite number of meanings depending on the context in which it appears: Thus, 'yes' may be said to have an indefinite number of values since it may appear in an indefinite number of contexts. 'Yes' with indefinite values (Yes) contains 'yes<sub>1</sub>', 'yes<sub>2</sub>', 'yes<sub>3</sub>' to 'yes<sub>∞</sub>', all of which may have different meanings. Language is only meaningful within a context, and within this context it may be specific. Beyond a context, language does not lose its meaning but becomes indefinitely meaningful. The word may be thought of as a mathematical variable to which contextual meaning is ascribed. In this way, meaning is not only looked for in the word but is found clarified in the total contextual structure in which the word appears. It is, however, possible to create difiniens which explain the meaning of the difiniendum or which have the same or similar meaning as the difiniendum, but it is impossible to give meaning to an object, or to an act, as they are not symbols which have a meaning that can be explained. The importance of this statement to the understanding of movement phrases will be explained later in this chapter. The explanation or translation of any art symbol into any other media of communication and especially language, robs it of its 'import'. Art does not require exegesis for its import to be perceived. The interpretation

of any art form, for example, dance or the art of acting, in terms of words is necessary only in the possible illumination of the form. To respond to art is not to respond to the analysis of it.

Words are not amorphous and meaningless. They spring from a background that yields and even demands their existence. This background is a contextual movement one, which may not be elucidated by the individual. He may focus on that which is his need to articulate, without heuristically enumerating the possible area of discourse. An arrangement of words for sense requires an intentional logical order. This order is dependent on fitting externally into the individual's perspective.

'The perspective of sense is not just intellectual, into it enters a man's past experiences, his moods, attentiveness, agility and choice --- briefly how he exists.'<sup>1</sup> The perspective then, does not only exist at higher levels of abstracted thought, it includes man's physical reality as an object, and himself as a being subjectively felt through his movement experiences.

Korzybski, in his book Science and Sanity, gives the following argument of how language may be thought of as a process of abstraction from movement experiences. He argues that movement is experienced as change, and that language, as meaning, is experienced as relatively static. The outside world is a world of flux and the nerve endings in closest contact with the external world react in a shifting, moving way. These shifting experiences take place predominantly in the Thalamus of the brain. When the shifting, dynamic abstractions of the Thalamic region are phased to the higher centre of the brain, that

---

1. Zygmunt Adamezewski, Being and Sense, p.26.

is to the neo-cortical area, they become removed from the external world and are changed, in that they lose their shifting moving character. These higher phased activities, now experienced as ideas, are different from first order neural activities and are relatively static.

This description tends to show a confusion between neurological investigation and the concepts of ideas. It is a confusion between quality (ideas) and quantity (neural structure). An investigation into the state of nerve fibres and the proof that a certain state will give rise to a certain emotion or idea is a valueless undertaking. The quantitative analysis of neurophysiology does not have a one-to-one relationship with the qualitative nature of feeling. For example:

In the visual system the signals from the left and right halves of each retina are split at their source and sent to widely separate halves of the occipital cortex of the brain at the back of the head, yet our normal visual experience reveals no detectable sign of this splitting of the 'visual map'.<sup>2</sup>

The underlying idea, however, of feeling and mind being phases of the total excitability of the human systems is worth investigation and this will be related to Susanne Langer's thesis of mind being a development of feeling.

Korzybski refers to the thalamic area of the brain as being concerned with emotion and the cortical area as being concerned with ideas. It is generally agreed that the thalamus processes signals from all the sensory systems and that the cerebellum is responsible for balance and the precisions of skilled movements. However, when discussing functions of the brain areas it is difficult to associate specific brain areas with uniquely specific functions. For example, although lesions in clearly

---

2. Donald Mackay, The Human Brain, from The Science Journal Special Issue, May 1967, p.12.

defined areas cause clearly defined disorders, it does not follow that the specific function is stored in that area.

Language can still be omitted to some extent even after complete obliteration of the left hemisphere in a right handed person.

Smith (1966 b) describes a forty-seven year-old right handed man in whom the whole of the left hemisphere was removed for the treatment of a neoplastic lesion but who, six months after the operation, was able to comprehend all that was said to him and was even able to utter short, simple stereotyped phrases, obey written commands and sing tunes to command. This suggests that even if verbal expression is confined to the activity of the left hemisphere, comprehension of speech is not; and Jackson's contention, that whereas propositional speech may be confined to the dominant hemisphere, emotive speech can be carried out by the other, is confirmed.

However, a clear understanding of the role played by the right hemisphere in speech is difficult to obtain, for, as Archibald and Wepman (1968) point out, in most cases of right handed injury other factors such as preservation and general intellectual deterioration make assessment of the language function extremely difficult. 3

A similar difficulty is encountered in localising emotional function in the brain. Before the 1930's the emotional seat of the brain was considered to be palaeocortex, a thin layer between the outer cortex and the centre of the brain. Recently research has moved its interest from the palaeocortex to the hypothalamus as an emotional seat. In most experiments done on rats, emotionalism is equated with the basic drives of hunger, thirst and sex. To speak of rats as having emotions is

---

3. Moyra Williams, Brain Damage and the Mind, pp. 112 and 113.

open to question. For example, in the experiments done by N.E. Muller, C.J. and J.A.J. Stevenson at Yale, the discrepancy between a low hunger drive and voracious behaviour in rats that have had the small hypothalamus region electrically coagulated, has not been satisfactorily explained.<sup>4</sup> Furthermore, the direct transference of experimental data from animals to human beings is open to much conjecture. What is meant by emotion in rats cannot be said to be true of human beings. Electrical stimulation of the hypothalamus in rats seems to have a similar behavioural response in fish, bird, cats, dogs and monkeys and yet when brain probes were implanted in human beings by C. Jacobson of Norway, R. Heath of Tulane, Delgado of Yale and others, the responses were not shown to be similar to those of the animals.<sup>5</sup>

The effects of stimulation in the hypothalamus were correlated with confusing behaviour and confusing reports. In some experiments the patient would self-stimulate by manipulating a switch which caused stimulation via hypothalamic probes. With certain probe placements the behaviour was very intense, appearing not unlike what would be expected on the basis of the animal experiments. However, there was a characteristic of the human behaviour which paralleled that of the monkey but differed from that of the rat, namely that the responding did not cease when the current was no longer available. Even this parallel response between monkey and man must be questioned as the patient was capable of reporting on his response whilst the monkey was not. Furthermore, the patients did not seem to know whether they were being stimulated or not, and their reasons for self-stimulation through voluntary switching on the electrical current were confused. 'One patient, for example, said he did it because the doctor wanted him to, or to earn favours from the hospital staff.'<sup>6</sup>

---

4. Discussed by James Olds, Emotional Centres in the Brain from The Human Brain, pp. 103-105.

5. Discussed by James Olds, Emotional Centres in the Brain from The Human Brain

It is obvious from the above that the presence of mind in the human being creates a complexity that animals do not seem to possess. Emotion, furthermore, requires definition in terms of animal and human beings as two separate classes of individuation. In the study of the behavioural sciences 'emotion' has a very broad spectrum of meaning.

The philosophers of science and mathematics have drawn a great black line between propositional language used to state facts as unequivocally and literally as possible, and all other kinds of expression and their various purposes, which are lumped together under one caption, 'emotive'. This category embraces self-expression, the symbolisation of wishes and fears in dreams, or fantasy, myth, and other religious beliefs, and all artistic expression which positivistic thinkers generally regard as an exhibition of the artist's own emotions, either in lyrical sighs and confessions, or by representation of things which evoke his emotive responses. 7

The placing of 'drives' and 'emotions' within this latter category has been questioned by psychologists such as Lashly, Headrick, Head and R.S. Woodworth. The latter in Dynamics of Behaviour has questioned the traditional distinction between motivated and emotional acts.

High activation is likely to have an emotional character, especially when a drive is prevented from reaching its goal quickly. Intense hunger or thirst is not usually called an emotion but it undeniably has an emotional character. An intense sex drive is admittedly emotional, and so is an intense drive to avoid or escape from danger.8

However, this reading or interpretation of functional movement acts as being either goal motivated or emotional remains unclear, as the very nature of motivation and emotion escapes a linguistic definition.

Another danger in considering the motivation of acts in terms of causation principles is that of Vitalism. It is possible to argue that

---

7. S.K. Langer, Mind: An Essay on Human Feeling, p.157.

8. R.S. Woodworth, Dynamics of Behaviour, pp. 60 and 61, quoted in S.K. Langer in Mind: An Essay on Human Feeling, Footnote on p.278.

primitive man was a vital animist who imported 'will' to all that existed beyond his skin. He sees the world as being wholly other and with the power of initiating movement. As such, these 'wills' that are separate from himself, often urge him to act against his own will. He argues that in all things living or dead, there is a mysterious and unpredictable quasi-physical force or awesome energy which presumably is given by a power beyond things. He may profess hierophany (the act of the manifestation of the sacred) and he formulates a concept of the Godhead. This, as well as the ability to have a numinous experience, in which the inner is mislocated as being outside, allows primitive man to see his own reflection in the mirror of the universe. He thinks that he has existence in a substantial way in that the Godhead rewards his successes and punishes his failures. His freedom is only a small scrap of the omnipotence of the Godhead and the whole omnipotence of God is not made less by its fractionation. His freedom is that of anima, a subjective spirituality. It is the principle of animal animation, which radiates from the id. He sees in himself the microcosm of the universe's macrocosm.

Western La Barre has pointed out in The Ghost Dance that 'As concepts, mana and anima, microcosm and macrocosm all show a confusion of self and not self; son and father; father and the universe; organism and environment, and the moral and physical environment.'<sup>9</sup> In other words the omnipotence of a Godhead dwells only in a superhuman dimension, and therefore appears to the human level as a projection.

This confusion that arises when man equates his sensations of expending energy with a total Universal or Cosmic Power may be avoided by defining the individual and elucidating the nature of his vital energy.

---

9. Western La Barre, The Ghost Dance, p.38.



Man experiences energy through movement and is aware of its growing or shrinking potential. In order to formulate a concept of movement, S. Langer has developed a biological philosophy of acts, in which the word 'induction'<sup>10</sup> is used to explain the process whereby 'One act or a complex of acts, may be said to induce a new act; ultimately the entire situation whatever its stage at the time in question, induces any and every act.'<sup>11</sup> Furthermore, acts may serve as inhibitors of other acts and as such, a very complex pattern emerges. The experience of vital energy then, is this constant flow of induction or inhibition among movement acts which may reach a psychical phase or not. Once man wishes to think of this flow of potential energy he must abstract from those phrases which have reached an observable or introspective condition and synthesise those peak points of excitability, and so create a model of man's total potential. This model will then serve only to illuminate the possible form of the induction/inhibition flow of acts. The complexity of such a model would be staggering. However, it is possible to arrive at an approach to the subject matter whereby the nature of the discourse is more true of the basic vital processes which are constantly going on in living organisms.

The qualitative texture of vital energy may be thought of as being composed of a unity in which there are different dimensions. It should not be thought of as being a layered structure of physical energy, psychical energy and mental energy, as this leads to thinking of these layers as being separated from one another. Each phase of energy is able to induce or inhibit energy qualities which may be growing or shrinking at different phases. It is important to state that the concept of phased

---

10. S.K. Langer, Mind: An Essay on Human Feeling, Volume I, pp.281 and 326.

11. S.K. Langer, Mind: An Essay on Human Feeling, Volume I, p.281.

energy is derived from S. Langer's concept of phased feeling,<sup>12</sup> and is based on the human being's ability to distinguish between what he experiences as physical and what he experiences as emotion and thought. This concept of experiences felt as impact (physical) and experiences felt as arriving from an inner impulse (emotion and thought) should not be considered as having specific points of shift from phase to phase. Rather it should be thought of as an arrangement of vital energy, harmony or dissonance, much like the harmony of music which allows for major or minor keys or the five tone key used by Debussy.

If one places differently phased energy potentials on a model of a dimensional cross, it is possible to see structural relationships between the phases. A, B, and C are differently phased energy

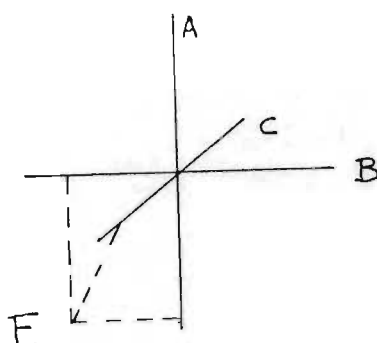

Fig. 1

processes, which may inhibit or induce the appearance of energy as an act at F. Thus energy, which to the observer of movement appears as dynamic nuances within the flow of spatial form, has a relative value on the other dimensions of human existence. That is, bodily movement has a relative value and relationship with mental and psychic processes. Energy is not only a reaction to environmental pressure felt by the individual as an impact, nor is it only a projection of internality felt as an impulse, but, in all its phases, it is cyclic and continuous.

12. Discussed by S.K. Langer, Mind : An Essay on Human Feeling, Vol. I. Chapter One especially p. 20

S. Langer has given a very clear description of the interplay of acts which in this context may be seen as vital energy rhythms.

This dialectic of induction and inhibition may exhibit very elaborate patterns, in which more than two processes become involved to effect the prevailing and continuous balance of life. Sometimes the activity of one functional unit instead of directly initiating its antagonist and so limiting its own operation, induces the activity of another unit, which then provides the inhibition of the first; sometimes they become each other's monitors, and sometimes the second unit - the inhibitor of the first - is limited by still another factor in the organic situation. Where many rapid, circumscribed rhythms are going on, some of these may summate and set up new, superimposed rhythms; or powerful periodicities, extraneous to the organism, may 'entrain' its natural rhythms, as the stronger intraorganic cycles always tend to entrain the weaker ones; so the sum total is still further complicated by the fact that activities deriving from widely differing sources, from central and peripheral impulses, may intersect and interweave and modify each other in the system. <sup>13</sup>

This description avoids the necessity of referring to an act centre or to central motivation beyond which vitalism emerges again. The description escapes metaphysical implications. Energy, if it is to have value to a discussion on artistic creativity, should also avoid being used synonymously with 'will'.

Energy, as a principle of movement in man, is very different from the concept of mental directing. Nietzsche in his essay on Guilt, Bad Conscience and the Like, has written in reference to man, that nature has set itself the paradoxical task of breeding 'an animal with the right to make promises'.<sup>14</sup> This right to promise also gives man the right to be forgetful. Nietzsche explains that forgetfulness is an active and positive faculty, in which man allows only a part of his experiences to

---

13. S.K.Langer, Mind: An Essay on Human Feeling, Volume I, p. 326.

14. F. Nietzsche, On the Genealogy of Morals, p.57.

filter through to his consciousness, and he actively forgets the cacophany of the lived experience. In this way his consciousness has material to conceive of order, of melody and harmony. This he achieves through memory.

This involves no mere passive inability to rid oneself of an impression, no mere indigestion through a once pledged word with which we cannot 'have done', but an active desire not to rid oneself, a desire for the continuance of something desired once, a real memory of the will.<sup>15</sup>

This 'memory of the will', although it spreads the concept of motivation from an animalistic impulse or desire to a considered moralistic determination in terms of past experiences actively projected into the future, remains as a motivational theory on the metaphysical level. Here the 'memory of will' can have no direct causation of movement. In order to escape from the confines of metaphysical debate and to extend the concept of energy beyond the drive theories of the psychologists, it is necessary to look at the effective way an individual interacts with his environment. The energy, used in environmental interaction will be shown to be fundamentally different from instinct, 'free will' or drive theories.

The idea of vitalism, that is that living things are beyond the laws of chemistry, biology and mathematics, and the mechanical view that is that living things are machines subject to laws of nature, stand at two extremes. Descartes (1637) attempted to unify these two views in his concept of man as a highly complex machine with a mind and soul that was not subject to the mechanistic laws. The early nineteenth century physicists focused on the word 'energy' to explain the process whereby living organisms

---

15. F. Nietzsche, On the Genealogy of Morals, p.58.

produce 'work' which converts food or sunlight into necessary substances in order to continue living. In the mid-nineteenth century the Vitalists came to the fore again when it was discovered that living cells were only produced by other living cells, thus substantiating the vitalist theory that life was only created by other living things. Later, Büchner, showed that the active agents in fermentation were not living. The discovery of enzymes, which in the mid-nineteenth century could not be analysed, were claimed by the Vitalists as being fundamentally beyond physical laws. With the invention of the electro-microscope it was shown that nucleic acid was the material responsible for the hereditary process, and it controlled, through protein-enzymes, most living activities. In 1953 the work of Watson and Crick at Cambridge established the framework of how deoxyribonucleic acid (DNA) is able to control the life process and that DNA is fundamental to all living activities. Thus Vitalism disappeared once and for all.

In considering the smallest unit of life, the cell, it may be shown that the dialectic 'interaction' between organism and ambient, rather than DNA sole agency (stimulus → response), is the principle of growth and development. The cell is the smallest unit capable of sustaining life. Some biologists regard viruses as units although it has been argued that, because they are incapable of self-propagation except through the agency of the processes in the living cell, they are neither organic nor inorganic but somewhere between the two.<sup>16</sup> They have also been described as 'naked genes' because of some striking similarities to genes.<sup>17</sup> However, this problem of classification according to structure or function can be illuminated by considering the nature of acts.

---

16. Discussed by Royston Clowes, The Structure of Life, p.144.

17. Discussed by W. Beadle, Genes and Biological Enigmas, Science in Progress (1949), pp.184-349.

Because cell structures differ according to the bodies or organs in which they are found, there are no typical cells. There are, however, certain structural features which are common to all cells. These structural features are based on albuminoids, nitrogenous organic substances in combination with fats; water phosphorus and many mineral salts. This forms a protoplasm which is characterised by viscosity, osmosis and catalysis. The membrane surrounds the cell and encloses the cell sap or cytoplasm. The cytoplasm, again a common structural feature, contains organelles, the most central being the nucleus. These structural features do not provide sufficient evidence of the cell's individuation. For further clarification it is also necessary to discover the nature and relationships of the acts that take place within and immediately outside the cell.

The boundary of the cell is the cell membrane. It is about 75Å thick and consists of three layers: the outer layer and the inner layer of protein enclose a fat (lipid) layer. The individuation of the cell is not seen in the physical presence of this barrier but in the acts that it allows the cell to perform. One of the main characteristics of a living cell, as distinct from a dead cell, is the selectivity of the membrane, which can distinguish various chemical molecules and atoms and which allows some to pass through rapidly whilst excluding others. The loss of this 'act' is an indication of the cell's death. Individuation then, is a process which responds to the vital situation of the environment. Within the cell the cytoplasm contains macromolecules of complex proteins and nucleic acids. The acts that involve these agents are a recreation of similar macromolecules from the simpler chemical environment in which the cell exists. The environment invades the cell through the endoplasmic reticulum. These channels may also connect the mitochondria and other

bodies. Often the endoplasmic reticulum is lined on the interior with ribosomes and these, with the assistance of the permeable membrane of the endoplasmic reticulum, synthesize protein from those chemical molecules which are allowed to pass through the membrane. Furthermore the nucleus contains nucleoli which are also made up of nucleo-protein and are the main centres of protein and nucleic acid production within the nucleus. Chromosomes, also constituents of the nucleus, are the agents through which the processes of meiosis and mitosis of the cell in reproduction are observed. The total interplay of action including the acts of meiosis and mitosis in cell division (growth and development) constitute the individuation of the cell. The synthesis of biochemical matter corresponds to the complexity of interrelated acts within the cell. It will be noticed that the agent (often an element of the organism or a chemical in the organism) is not taken to be the initiator of the acts in the sense that agents are first and acts second. This can be explained in terms of molecular structure, although chemical interaction is not the same as organic acts.

Ionic or polar bonds cannot be described as physical entities. The carbon atom is the most unique among the simple elements in that it loses its ability through either requiring four electrons or losing four electrons. The polar bonds that unite each electron with the atom become progressively tighter as each electron is removed, for this reason carbon atoms share electrons with other elements to form non-ionic or covalent bonds. Thus the structural formula of the atom, that is, its ability to gain or to lose or, in the case of the carbon atom, to share electrons, is what defines its individuation. Similarly polymers are determined by the monomers (each small molecular link or sub-unit in the chain which

constitutes macromolecules) and by the type of chemical bond which joins them. Bonds may be described as masses in movement which result in organic organisation.

This organisation may be described as follows:

Frequently in Nature a series of compounds is found which differs only in the number of links in the chain. Perhaps the simplest example exists in the compounds known as paraffin hydrocarbons, which are found to be the principle components of the petroleum and crude oil. These are compounds each built up of different numbers of the same repeating unit, which is in this instance a carbon atom with two attached hydrogen atoms, i.e.

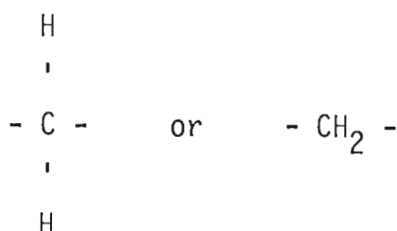

Fig. 2

with an extra hydrogen at the beginning and end of the sequence. The general formula of a paraffin hydrocarbon can therefore be represented as  $\text{H} - (\text{CH}_2)_n - \text{H}$ , (or  $\text{C}_n\text{H}_{2n+2}$ ), where  $n$  is any number from 1 up to 30 or more. ... Ethane has two  $-\text{CH}_2-$  subunits, propane has three, and butane four. ...

For example:

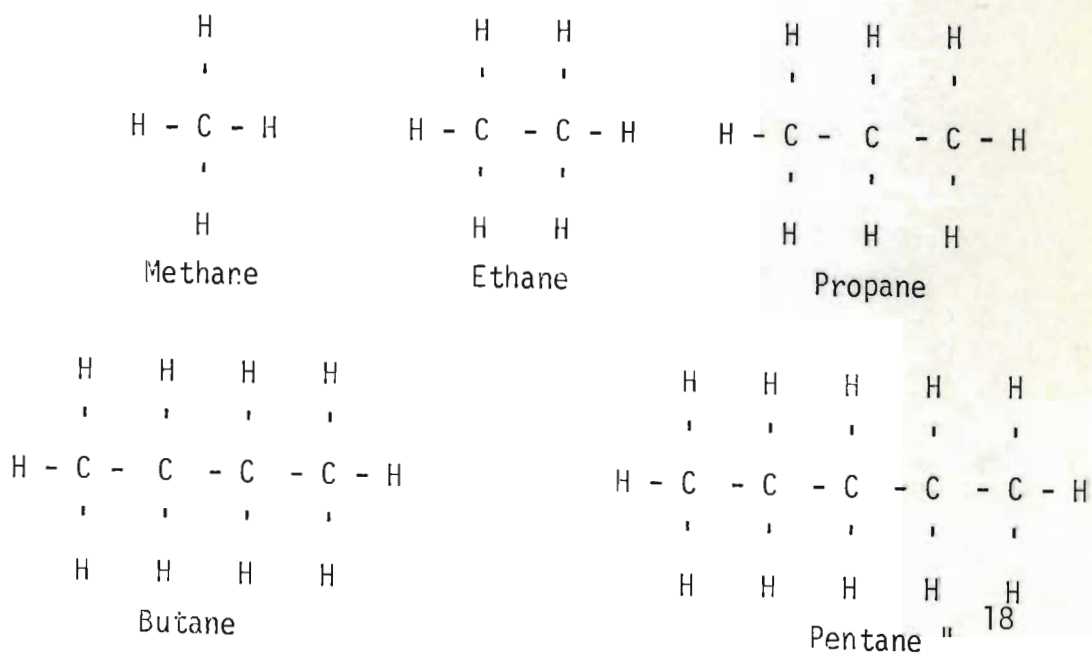

Fig. 3



In the above examples the process, the acquiring of the repeated unit -  $\text{CH}_2$  - determines the agent as methane, prothane, or pentane, etc.

In biology, the Traditionalists categorised according to physically acquired characteristics. In the following processes instead of physical forms as solely defining characteristics, the dangers of Morphology (where the characteristics independent of function are considered) are avoided. In discussing dynamic processes it is essential to avoid creating artificial boundaries between genus and genus, agent and agent or phase and phase. The flow of acts, in their growing/shrinking inter-relationships, supplies a framework in which life as process, and therefore creativity as process may be considered without creating artificial boundaries.

It is now necessary to discuss the processes of specialisation of function, since later creativity will be considered as a specialised process in which man's individuation is determined. The process of specialisation of function and therefore of structure has its origin in the work of Charles Darwin. His theory of 'natural selection' gave rise to a system of classification of species that was based on similar resemblances of parts of the organisms and genera due to environmental interaction.

We must not, ... in classifying, trust to resemblances in parts of organisation, however important they may be for the welfare of the being in relation to the outer world. Perhaps from this cause it has partly arisen, that almost all naturalists lay the greater stress on resemblances in organs of high vital or physiological importance. No doubt this view of the classificatory importance of organs which are important is, generally but by no means always, true. But their importance for classification, I believe, depends on their greater constancy throughout large groups of species and this constancy depends on such organs having generally been subjected to less change in the adaptation of the species to their condition of life. 19

Although Darwin was unaware of Mendel's Laws of independent assortment and segregation, his theory is essentially confirmed by the study of genetics. Darwin's purpose was to explain an evolutionary progressive development which is summarised in his conclusion on the chapter on Classification.

Finally, the several classes of facts which have been considered in this chapter, seem to me to proclaim so plainly that the innumerable species, genera, and families or organic beings, with which this world is peopled, have all descended each within his own class or group, from common parents, and have all been modified in the course of descent, that I should without hesitation adopt this view, even if it were unsupported by other facts or arguments. 20

With the advance of microbiology, the nature of specialisation has become more clearly understood until the notion of 'natural law' as some divine law working through evolutionary processes may be radically reviewed. This has become possible through science being able to reconstruct in vitro life processes. Whereas Darwin's evolutionary theory was dependent on fossils, modern microbiology, is able to study mutations that occur in a relatively short time span. In the study of bacterial genetics or phages it has been discovered that certain specimens (especially *Escherichia coli*) grow extremely rapidly.

One great asset of bacteriophages over other viruses is their great efficiency: almost every phage particle is able to infect and multiply. If a few hundred particles are added to a bacterial culture of several million cells, then rapidly mixed with molten agar jelly, the agar layer will set and immobilise the bacteria. If this 'plate' is then incubated, in a few hours the bacteria will form a layer of growth composed of millions of tiny colonies over the whole plate. 21

- 
20. Charles Darwin, Origin of the Species, p.434.  
21. Royston Clowes, The Structure of Life, p.156.

Because of this extremely rapid growth mutants within succeeding generations may easily be discovered. The subject of the specialisation in terms of acts will be shown to be one of the relationship of potential of the individual to interact with the environment. Darwin's theory tends to place the environment as a dominant factor in the evolution of the species. If behaviour, in the sense of movement phrases of the individual, is seen as the process of individuation, then the environment loses this dominant position.

It is possible to view the study of genetics in such a way that chromosomes hold as dominant a position as the environment did under Darwin and, more recently, under the Behaviourists. Chromosomes have been described by many geneticists as the 'blue print' for the activity of the cell.<sup>22</sup> This activity is basically the synthesis of protein. The relationship between DNA and RNA nucleic acids and protein synthesis has been described as follows :

1. Double-stranded DNA is the primary carrier of genetic information. It multiplies by unwinding and building on to each single strand the complementary sequence of nucleotides.
2. For protein synthesis an unwound strand of DNA attracts to itself nucleotides of the A.C.G.U. series to produce a single strand RNA sequence that, as it were, transcribes the DNA information. It is called messenger RNA or m-RNA.
3. Messenger RNA becomes attached to ribosomes, minute granules made up of protein and another type of RNA, which function to direct the 'translation' of the m-RNA sequence into an amino acid sequence in a way that could be remotely compared with the way a tape-recorder translates sound into a sequence of magnetic configurations in the tape or vice versa.
4. Protein synthesis from the surrounding pool of amino acids is carried out by a collection of small RNA molecules called transfer RNAs, twenty of them, one for each type of amino acid. Each transfer RNA molecule can be said with approximate truth to be able to recognise with one end a particular thread of nucleotides, A U C for instance, and with the other end the corresponding amino acid, B perhaps (i.e. if B represents isoleucine).<sup>23</sup>

---

23. Macfarlane Burnet, Genes, Dreams and Realities, pp.40 and 41.

The above description tends to regard DNA as an initiator of events. The words 'For protein synthesis an unwound strand of DNA attracts to itself nucleotided ...' could lead back to Vitalism on a philosophical level. It implies 'decision' or even 'will'. If the processes, in which different proteins are synthesised, is subject to evolutionary mutations, then it is possible to view this process as different acts rising to peaks in conjunction with other acts and may be stimulated to further realisation of the phase by favourable environmental circumstances. Genetic mutations arise as a result of induction and inhibition of other acts going on within the cell structure and/or within the environment. The processes of DNA duplication and migration during mitosis and the process whereby one nucleus becomes two, require many specialised enzyme actions. These actions are susceptible to the inhibitive or inductive influences of chemical processes. When cells multiply within tissue cultures, it is shown that '... in every population of growing cells there is a competition for survival. A rapidly growing mutant will outgrow and replace unmutated cells'<sup>24</sup> and 'Mutations are rare, random and diverse, and the eventual mutant types which come to dominate two cultures, started from the same source, may differ in many respects ...'<sup>25</sup> What is essentially being described above is the act concept in which potentialities are realised in optimum conditions. It does not follow that all potentialities share the same optimum conditions for growth, rather, the struggle for survival, even at the cellular level, is played out with constant reference to the general movement flow of the individual in his dialogue with the flow of acts that are encountered in the environment.

---

24. Macfarlane Burnet, Genes, Dreams and Realities, p. 66.

25. Macfarlane Burnet, Genes, Dreams and Realities, p.66.

The nervous system gives an excellent example of 'the act' as the basic unit of the life process, it also gives a clear actual pointer to the concept of 'act potential'.<sup>26</sup> So far potential has been discussed in terms of cellular division and the development of mutations. In neurology however, potential may be discussed in terms of many interrelated factors within whole organisms. The individual, within this context, may be described as a system of differentiated acts, such as seeing, tasting, hearing and tactile sensations. This definition does not confine seeing to the eye, hearing to the ear or sensation to the skin. The essence of specialised act functions will be seen to lie in the relationship of sub-acts or micro-acts, both as inductive and inhibitive factors in realising the potential of an act that reaches the feeling phase.

The controversy as to what constitutes a neuronal unit, the specific cell or the whole nervous system as a large syncytial unit, has been settled in favour of Ramon y Cajol's theory. That is, neurons are separated from one another by means of the cell membrane. This was done through the use of the electron microscope. However, the concept of the individual as a self contained organism, the concept held by Ramon y Cajol, is based on 'individuation' and 'organism' being synonymous. It has already been established that the 'individual' may only be determined in relation to those acts which emerge as phrases from the general flow of acts. The initial phase of an act phrase has been called the 'impulse'. S. Langer describes it as follows:

---

26. 'A potential act, is, the, and impulse. It need not reach a stage of muscular contractions, nor of cerebration that records itself in galvanic skin reflexes. Its overt development may be wholly suppressed by the actualization of another, in compatible impulse; then it remains potential though it may be so for a long time, continued by repetitive pulses, or held unspent in its nascent state. The impulse, or potential act, is something that really occurs; even without the normal development here called "actualization", an impulse is an event.'

S.K. Langer, Mind: An Essay on Human Feeling, Vol. I, pp.299-300.

An impulse is usually conceived to be a homogeneous discharge of energy, the equivalent in animate nature of a force, or impetus in the organic realm. But no vital process is exactly like anything outside the context of life; it is always more complex. An impulse, or nascent act, is an offshoot of a fluid situation which, because of its unstable character from one moment to another, is probably never altogether determinable. Within the active organism, the very matter which is implementing an act, may undergo dissolution in the process and be transformed, so that it enters into another mechanism that functions in another situation. The first really identifiable element is the impulse; and this is already an articulated process. 27

This impulse is the emergence of rhythmic energy from the flux of general movement and its appearance is that of an act. With this emergency the form of the act becomes articulated.

The concept of an act impulse may be related to 'electric excitation' along an axon. How the act potential is brought about in nerve cells is still being investigated. However, the activity of the cell membrane, in terms of its sudden increase in conductance or decrease in resistance has been investigated. On either side of the membrane there are solutions of different concentrations of sodium and potassium ions. When the cell membrane increases its conductive power the sodium ions, which are on the outside of the cell membrane, move through the membrane to the solution inside; potassium ions, which have a different rate of permeability move through the membrane to the solution outside. Sodium ions carry a positive charge, whilst potassium ions carry a negative charge. When sodium ions flow into the solution inside the membrane they reduce the negative charge and change the resting potential. This is reversed when potassium ions, with positive charges, flow outward. The presence of calcium ions are essential for this action to occur. The chemical potential of calcium may thus be said to be an inductive sub-act in the act of impulse conduction along nerve fibres.

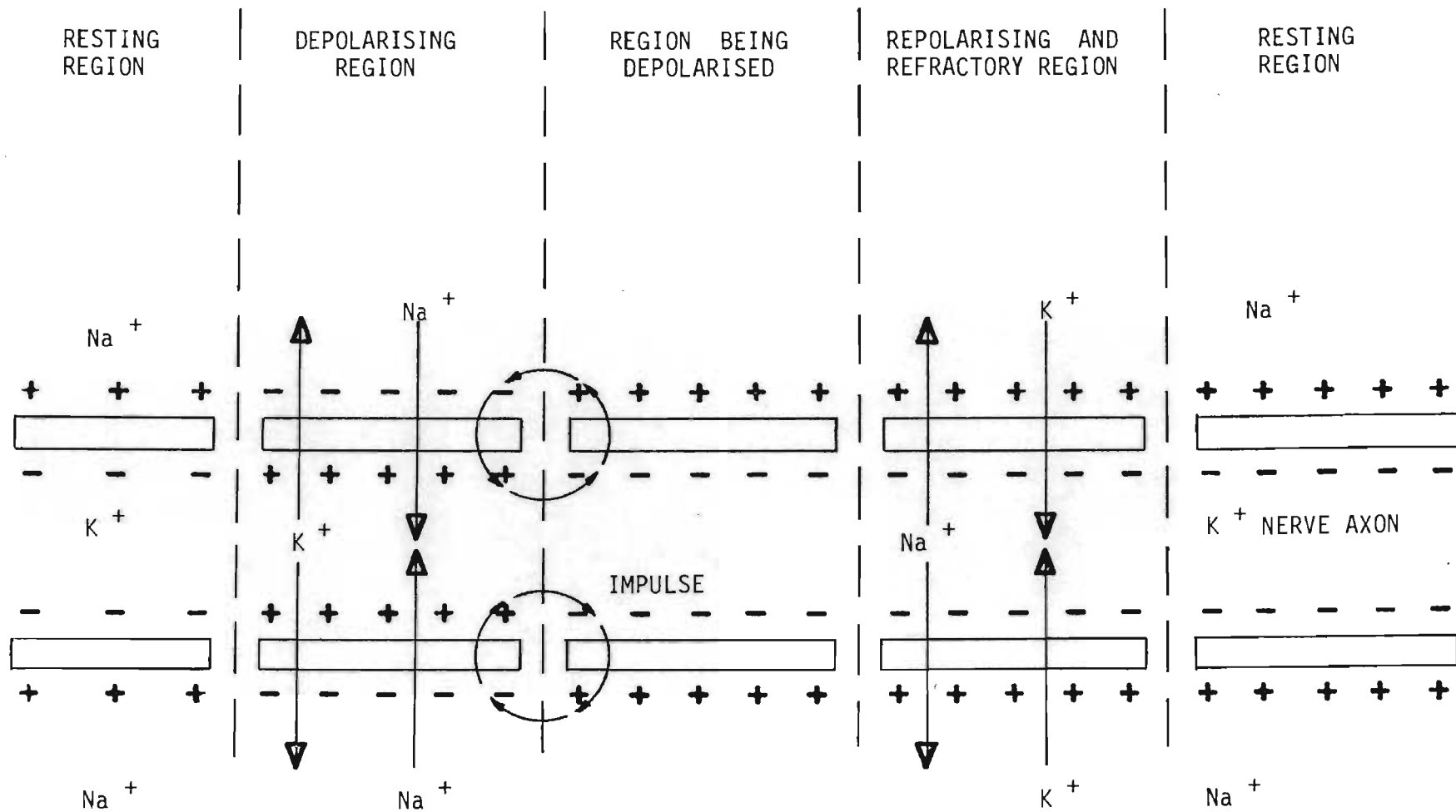

The above description of sodium and potassium migration across the discriminating membrane is simplified. What is however important, for the purpose of understanding the different phased relationships that may exist between acts is the different rate of permeability of sodium and potassium through the membrane.

It is a matter of special interest, that the Na (sodium) and K (potassium) permeabilities do not increase simultaneously, but the changes have a different time characteristic and are out of phase. The membrane continues to discriminate between the two ion species even in its depolarised condition, but the ratio of Na/K conductance is temporarily reversed. In the normal course of events, the initial change (increase of Na conductance) is a regenerative event leading to the self-reinforcing ascent of the spike. The subsequent process (namely, the cutting off, or 'inactivation', of the Na-transfer mechanism and its conversion into a state of greatly increased K conductance) is a self-repairing event. It causes an accelerated efflux of K ions from the axoplasm. This leads to a rapid fall of the inside potential to the initial level, which is automatically followed by a restoration of the original ion permeabilities. Thus the increase of K conductance is a process of negative feedback, which shuts itself off as it proceeds. It brings about a rapid termination of the active cycle and restoration of the normal excitability of the axon, leaving it in a state of readiness to conduct another impulse within 1 or 2 msec. 29

The different phases of the cyclic events of the action potential wave are measured in terms of depolarisation and repolarisation of the membrane. The potential excitability of the axon may be considered as the indistinguishable flux of movement out of which the act arises. The initial impulse of the action potential wave is already part of the act itself, and is distinguishable from the general flux of movement. The flow of the wave, in which there are three phases, depolarisation, the wave and repolarisation, is also necessary for the appearance of the act from general flux. The sodium conductance may be regarded as the initial impulse of the act which rises to a peak of excitability in the wave and dies down again in the repolarisation to resting excitability through the increase in



K permeability of the membrane. The building up of the initial impulse is not a simple stimulus/response action. It is dependent on many factors for example, the permeability of the Na and K outside and inside the axon, and the initial stimulus from neurons across synapses. The stimulus is itself complex in that the point of firing of any neuron, although an all or nothing discharge, requires impulses from many dendrites before the threshold of firing is achieved. This leads to a second consideration of potential energy in acts, that is, the spatial relationships of the sub-acts to the individuals that participate in any act.

It will be shown that besides the different phases which partially determine the nature of the act, the spatial relationships of individuals also influence the character of the act. Spatial and temporal values are, of course, themselves interrelated.

The ending of nerve fibres in the skin may be classified in three different ways: naked or free ending; complex endings and encapsulated endings. Complex endings show a large variety of forms from coiled structures to flattish disks and are used chiefly for registering mechanical deformation of the skin. Encapsulated endings respond to every sort of stimulus but especially to bending, stretching and compression of the skin. At any point in the skin there is a unique relationship of at least three nerve fibres and at no other point is there this same relationship. This may be illustrated diagrammatically.

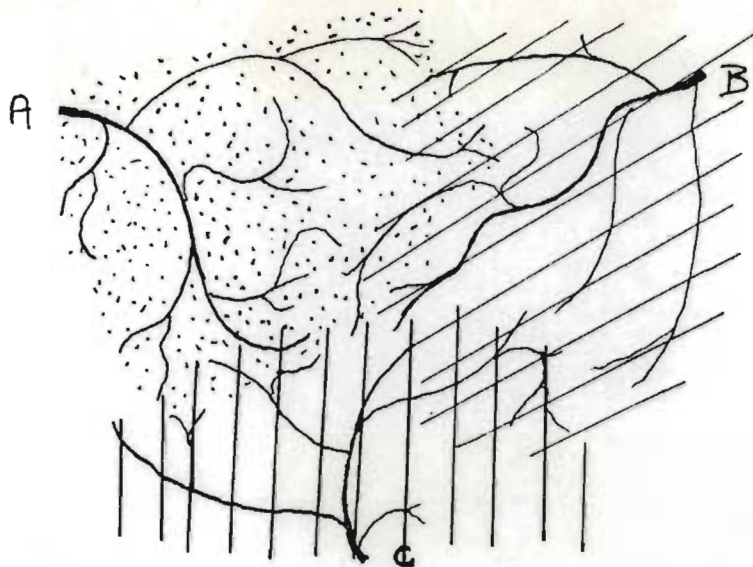

Fig. 5 Diagram to illustrate the unique relationship between three nerve fibres 30

If the skin is stimulated at point X the amount of excitation of each nerve fibre may be '10 per cent of A, 20 per cent of B, and 15 per cent of C'.<sup>31</sup> The final excitation in the brain which gives the localisation of the initial stimulus is partially dependent on the spatial relationships of the nerve fibres to each other.

Another example of spatial relationships is found in the act of seeing. Seeing is facilitated by the spatial arrangement of the rods and cones on the retina, and the interconnecting neurons and the ganglion cells from which the optic nerve arises. The fovea, on the retina, has a concentration of cones. Since cones require more light to be excited than rods and because of their high concentration in this area, the fovea allows for seeing of fine detail in good light. The inhibitive action of the ganglion in surround inhibition facilitates in differentiation of objects. When a pattern falls across the retina, those ganglia which receive stimulation from the rods and cones on the darker edge of the pattern of light, effect an inhibition of excitability. In this way objects are clearly defined.

---

30. Peter Nathan, The Nervous System, p.77.

31. Peter Nathan, The Nervous System, p.78.

The cell bodies of neurons are subjected to a great many influences, one of which is the shape and size of dendrites and the geometrical arrangements of the inputs.

Not all parts of the post-synaptic neuron are equally excitable. The parts of the dendrites farther away from the cell-body are less excitable than the cell-body itself. Excitation delivered far out on a dendrite may be insufficient to fire the neuron, but it may be enough to increase its excitability; then, further impulses arriving become more effective, until sufficient excitation is added up to make the neuron fire. 32

The importance of spatial and temporal relationships of acts may be illustrated through the way a single neuron facilitates learning. This is explained by E.G. Gray.

For example, a young animal might develop connections in the brain that lead from the vision centre on to a set of synapses or dendritic spines on a certain neuron. When the vision centre signals the appearance of a predator, the synapses are activated and depolarise the neuron so that its axon fires with certainty, perhaps to activate a motor centre for escape. Now other spines on the same neuron may be contacted by axons running from hearing centres. However, these synaptic contacts are non-functional. The roar of the predator, meaningless to the young naive animal, does not fire the axon. All we need postulate is that there is a mechanism which ensures that if the auditory inputs fire when the underlying post-synaptic spine and dendrites are being invaded by the wave of depolarisation set off by the visual synapses firing, then the probability of the auditory synapse effecting a depolarisation and hence firing the axon, increases. Thus the sight and sound of the animal will be associated and the sound itself will become an adequate stimulus to activate the escape centre with obvious advantage. 33

From the above example it can be seen that elements of temporality and spatiality are not independent of, or outside, the act. In the same way that the initial impulse is already an articulated part of the act, so the factors of spatial arrangement and temporal phrasing are articulations within the movement phrase. The modes in which space and time are

---

32. Peter Nathan, The Nervous System, p.109.

33. E.G. Gray, The Synapse, a paper in 'The Human Brain' from 'The Science Journal', pp.65-67.

articulated, the tensions that arise within the act, as well as those tensions that arise between acts, the influences of induction and/or inhibition and the qualitative nature of the individuals related to the act, constitute vital energy. Vital energy then, is a dynamic system that does not operate within the arches of time and space, but internalises space and time as integral dimensions of its presence.

The internalisation of space and time demands from vital energy that it should exist as flux. Flux, then can be described as a continuous succession of changes in temporal and spatial tensions.

The way in which acts have a natural potential for self completion will be discussed in Chapter 2. The prediction that such and such a situation will bring forth such and such an act is, by the very nature of acts, impossible. The variations of act-inducing situations are innumerable, as each act has its own unique potential and its own realisation of that potential. It is, however, possible to make generalisations about acts. In doing so, that which is common or which has similar tendencies is focused on, whilst those qualities of action that are different and which constitute the uniqueness of the act are left to lie on either side of that which is being considered. In this way generalisations are inclusive rather than exclusive.

CHAPTER TWO.

## THE BIOLOGICAL MODEL OF THE ACT.

Sir Arthur Eddington, in his discussion on models as a means of understanding the world, has written in The World of Mathematics:

We have pictured the atom as consisting of a heavy nucleus with a number of nimble electrons circulating around it like planets around the sun ... . You must not take this literally. The orbits can scarcely refer to a motion in Space. ... and the electron cannot be localised in the way implied in the picture.

In order to understand the movement that goes on in an act it is necessary to place something in the flow of action, so that the excitability, from the original impulse through the climax to its ebbing and fading away, may be noted in the thing which is placed in the action. Heeding Sir Arthur Eddington's warning, it should be noted that the 'thing' is not the action, and the excitement, which may be seen in the movement of the 'thing', is not the total excitement of the act.

For example, in the differentiation of tissue cells in the development of specific organs from an embryo distinct phases of movement activities may be observed. Experiments have been done in which given regions of an embryo have been shown to be destined to become ectoderm, chorda mesoderm, endoderm and numerous other tissues. In order to follow the pathways of specific groups of cells to their ultimate positions, vital stains are used to mark living cells. As a result, pathways of movement, which may be described as potential tensions and the resolutions of these tensions, are plotted by means of the moving cell. How these cells are set in motion is not certainly known. James D. Ebert and Ian M. Sussex in Interacting Systems in Development, describe movement

---

1. Sir Arthur Eddington, The World of Mathematics, pp.1560-1561.

as a 'property of individual cells',<sup>2</sup> rather than a force that propels the cell from without. However, the influences of the environment on the cell and the interaction between cells in a common micro-environment may also guide the movement.

... abundant and compelling chemical evidence exists to show how the changing chemical environment results in the differential expression of genes, with telling effect on the course of differentiation. Enough has been said to emphasise that the conditions for differentiation, achieved through the interactions we have referred to is inductive, may differ widely and thus a search for a single, universal 'inductive agent' is illusory.<sup>3</sup>

This is true of any act; there are no single causative agents and therefore no universal causative principles. To assume that there were would be to deny the very nature of organic growth.

The cumulative changes that go on within the cell, that is migration of large or small molecules through the membrane of the cell, are all below the level of direct observability and perhaps even that of the imagination. For this reason the migration of the cell to its final position in the grown organism is not an isolated act clearly demarked in all its dimensions. The excitability of the cell (the migration of the cell and possibly the change of shape in each individual cell) does not constitute the total excitability of the act. All acts have sub-acts which are for the most part below the level of observability and which are act-agents of induction and/or inhibition depending on the phase at which they exert their influences.

The initial stage of any act is the impulse which is itself part of the total phrase; it is not prior to the act and therefore not a stimulus. The temporal relationships of acts on one another are extremely complex and it is from this that the impulse emerges. A movement phrase

---

2. Ebert and Sussex, Interacting Systems in Development, p.53.

3. Ebert and Sussex, Interacting Systems in Development . . .

which appears as an early influence on another act may induce or inhibit that initial impulse. However, the same act appearing as a late influence in the history of another act may fail to inhibit or induce. This is clearly described by Ebert and Sussex in terms of cellular development.

If the upper part of an early amphibian gastrula is cut off, rotated 180° and replaced, the cells of each region will come into new relations with those of the lower hemisphere. Once the graft is healed, normal development continues. Neural tissues develop in their usual position: epidermal tissues in theirs. This means, however, that neural tissues of the operated embryo are formed from what had been prospective epidermis, and epidermal tissues from prospective neural cells.

And

In short, in the early gastrula the cells in these two areas, prospective epidermis, and prospective neural tissues have not yet been determined. They are not yet restricted to a single pathway. 4

However, if the same experiments are performed just two days later, at the end of gastrulation, the results are quite different. Prospective epidermis placed into the neural region differentiates as epidermis. It does not conform to its surroundings and may interfere, mechanically with the formation of neural structures. Prospective neural tissue placed in the region of epidermis develops into brain-like structures. Thus within this time span, during gastrulation, the capacities of these two groups of cells have been restricted. They are said to be determined. In fact development involves a series of progressive determinations, of progressive restrictions of developmental capacity. 5

From the above it can be gathered that the longer the act is in progress the greater is the tendency for the impulse to grow in its potential for realisation. It seems that whilst acts are moving towards a climax, they increase in their qualitative and definitive energy capacities and once the phrase has exhausted its potential in the climax, it decreases

---

4. Ebert and Sussex, Interacting Systems in Development, p.63.

5. Ebert and Sussex, Interacting Systems in Development, p.64.

in definition and quality. Whilst on the decrease, an act may easily be inhibited or totally submerged by another act or other acts which are gathering towards definition and quality. The way in which the impulses may grow is however dependent on other factors besides longevity of expression. It is also dependent on:

... (1) their chances of implementation; (2) their organising propensities, which depend largely on the opportunities they create for sub-acts to develop, and for lesser acts to become entrained; and (3) the energy of their original motivation, which may be greatly enhanced by confluent impulses in the course of actualization. 6

The original impulse of an act, which is part of the act itself, grows in complexity and intensity at the cellular level, according to the chemical interaction within the cell and the interaction of cell substances with the chemical environment through the membrane. The membrane which encloses a spatial area is important in understanding the internalisation of space as an initial implementation of the act.

This may be seen in all organic forms of life where the individual creates its ambient by means of a separation. Initially this separation happens on the physical level. In the case of the cell, this occurs by means of the membraneous wall. Although a comparison of outer surfaces or membranes in different organisms shows a difference of complexity and of function, the outer surface is in all cases effective in organising a wholeness of definition against an ambient. The importance of the periphery holds for all creatures, no matter what their degree of complexity, size or behavioural freedom. This is especially true in free

---

6. S.K. Langer, Mind: An Essay on Human Feeling, Vol. I, p.416.



living animals, which may enter new environments, where

... the structural articulation of the surface membranes plays a leading part in the evolution of their organisation. So it is not surprising that even in the protozoans any advance of complexity of the creature as a whole involves, a great elaboration of the enclosing membrane, which may be granulated, ciliated, divided into layers, perforated by pores, and tubules and fibres that turn one kind of terminus inward into the cytoplasm, and a differently qualified ending outward toward the environment; the outermost layer, and even the deeper ones, may be spun out into fine hairs which still have internal structures, differentiated perhaps to the molecular level. 7

Besides this difference of texture of the membrane, the plastic enclosing of a space and the differentiation between an enclosed space and an environment are always present and are essential in the concept of individuation. The membrane has been discovered to be adaptable. Form and function are not always fixed even in adult or mature cells. The concept, that the membrane encloses a space which remains the same during the organism's life span, is contrary to the theory of acts. It will be shown that it is more profitable to conceive of the membrane as being continually in the process of enclosing a space.<sup>8</sup> In this way the space itself becomes a factor in the action of enclosing. Instead of a division or an enclosure of space being recognised as the enclosed space and the ambient (this division being a separation) the enclosure will be seen as a space with an environment (the division being a conjunctive). The act does not become implemented against space but internalises space in the action and thereby creates vital plastic space. For space to have vital energy there must be movement.

The chances of implementation of the act are therefore dependent on the internalisation of plastic space. This initially brings about

---

7. S.K. Langer, Mind: An Essay on Human Feeling, Vol. I, pp.419-420.

8. Discussed by William Montagna in The Structure and Function of Skin, p.42

a division which creates an ambient with which it has a dialectical interrelation. The ambient is constituted of other acts and so any particular act depends further on the organisational propensities of act and sub-acts in the ambient.

In any act, the chance of implementation and completion is dependent on the ordering of sub-acts, and on the ordering of vital appearances of energy. The ordering of cells in morphogenesis is one of the major forces in the development from the fertilised egg to the mature individual. Clinical interference with the developmental flow of action in the embryo has shown that one of the basic forces within this act is ordered relationships. These are both spatial and temporal.

One of the basic principles underlying development is that genes determine the specific nature of molecules, proteins, cell type and structural configuration. Individual genes within cytoplasm have different surroundings or positions within the egg. The position of the gene and the cytoplasmic surroundings seem to effect genetic expression. There is strong evidence that there are regional cytoplasmic differences in eggs.

At one end of the scale - in eggs of ascidians, annelids, and molluscs, for example - the undivided egg is highly organised: from the very beginning of cleavage, the daughter cells are specialised; the restriction of developmental capacity occurs early. Thus in these forms nuclei come to lie in regionally differentiated cytoplasm from the outset of development. These regional differences are shown most graphically by defect experiments in annelids and molluscs. In the eggs of some marine snails and mussels immediately before the first cleavage, part of the egg protrudes as a 'polar lobe'; at division it remains attached to one blastomere into which it is withdrawn only to reappear during the next division. This lobe makes an attractive target. When the lobe is amputated, the embryo develops but imperfectly, the resulting larvae lacking mesodermal structures. Thus, this localised region contains materials essential to formation of mesodermal structures. 9

The motivational force in the act of differentiation is, then, cyclic. The notion of stimulus - response, becomes that of response - stimulus - response. In this way no two acts are identical and no act may be exactly repeated because each act is based on the response of its predecessor. In other words no two acts have the same history.

Inductive interactions between acts need to be highly organised in their spatial and temporal relationship for implementation of function to occur. The bodies of vertebrates develop in the presence of constituent tissue interaction. For example, when a frog embryo is experimentally caused to exogastilate, so that the chordomesoderm does not come in contact with the overlying ectoderm, the ectoderm fails to develop into the nervous system.

Thus the micronenvironment and the original equipotentiality of cells show effects on the changing situations of development. The pattern of change is ordered. In each individual of a particular stock there is a repetition of this ordered pattern of development. The course of actualisation, however, is always modified to some extent by contingencies of the organism's situation as a whole as well as its internal transient condition and the degree to which its deviation from the generic norm can do without destroying the particular life - that is, the amount of leeway in the creation of individuation - is itself part of its heritage. 10

Later this ordered pattern of change will be discussed in terms of artistic creativity and will be shown to be one of the major factors in both the unique quality of each work of art as well as in the communicability of art.

Temporal expression of acts tends to be more obscure than spatial expression, especially when related to genic action. For example, in the abnormal XXY chromosome man, the prenatal and postnatal development is

---

10. S.K. Langer, Mind: An Essay on Human Feeling, Vol. I, p.413.

completely normal until puberty. Then the seminiferous tubules atrophy, the testes remain small, and the individual becomes eunuchoid. At puberty the mechanisms of spermatogenesis are activated in response to hormonal stimuli, the hormones are produced as a result of genetic acts, and it is only at this stage in the temporal development that the extra X chromosome is expressed. Genetic acts are for the most part below the level of observability. The result of genetic expression may be observed in modification, mutation, death, failure or organisation, duplication of parts, deficiency or excess of a specific product, but this does not tell the observer when the genetic expression took place. It may have been immediately prior to the observed event or it may have occurred long in advance of it. Many sequential acts may be initiated by genetic action in the form of an initial impulse and thereafter the act continues independent of nucleic guidance.

In regard to specific functions in vertebrates and especially the temporal expression of functions of specific organs, e.g. ovulation in the female, predictable temporal cyclic patterns are found. The rhythmic interplay of spatial and temporal acts is extremely diverse in man. There are certain cyclic events which are determinable and their temporal rhythms discernible. In the development of the heart which is a mesodermal organ, the definitive function begins as soon as the paired primordia fuse.

The paired rudiment fuse from anterior to posterior, from the head towards the tail. The first regions of the tube to be established are the truncus arteriosus, the anterior most division leading to the ventral aorta, and the heavily muscled pumping chamber, the ventricle. Next the atrium, the chamber designed to deliver blood to the ventricle, arises. Finally, the receiving chamber for venous blood, the sinus venosus, is established. A number of investigators, beginning with Florence R. Sabin, have analysed the origin of the heartbeats. The first twitching can be seen early in the second day of development. The slow but rhythmical beat begins along the right side of the ventricle and gradually involves the whole ventricular wall. Soon the entire muscle of the ventricle is contracting synchronously - periods of pulsation alternating with periods of rest. Meanwhile, the atrium has been forming. As it takes shape, it too begins to contract but at a more rapid rate, which governs the rate of the heart as a whole, the ventricular rate being increased. 11.

Here there is an interplay of rhythmic pulsations. In the fully developed heart the pacemaker or sinoatrial node sets the pace for the entire heart. The faster contractions of the pacemaker increases the slower pulsations of the rest of the heart. The neurological or biological explanation for this is lacking. It does, however, demonstrate empathetic interactions, where the stronger and faster beat influences the weaker and slower one.

This leads directly to another factor in the growth of acts namely, the organising propensities, which allow for lesser acts already in progress to become entrained. The development for the cardiac pulse is an example of the entraining of lesser or slower beats into a faster rhythm. The power of an act is made stronger by means of 'chordic harmonies'. This is also aptly illustrated in the act of listening. The human ear is capable of discerning the frequency, intensity, timbre, growth, duration and decay of the tone, slide or protamento and vibrato of a single note. In the reproduction of a musical note the correct

---

11. Ebert and Sussex, Interacting Systems in Development, pp. 83-84.

intensity of sound must be produced. If this is not done the frequency of the reproduced note may be correct but the pitch will be wrong. This is because pitch is determined by the correct overtones. Bass notes require more intensity than treble notes.

In the inner ear there is a basilar membrane which in man is thirty to thirty-five millimetres long. Globular hair cells are supported along the inner part of the membrane and slender tubular ones along the outer part. The hairs of these cells adhere to the tectorial membrane above them. When sound is transmitted to the inner ear it is converted into a wave-like motion along the basilar membrane. This moves the hair cells, the tips of which are embedded in the tectorial membrane. The pressure wave in the tectorial membrane is different to the basilar one due to differences of attachment, thickness, elasticity and tautness. The difference in the movement of the two membranes causes the hairs of the hair cell to twist, which set off nerve endings around the hair cell. A change of frequency of one semitone brings approximately four hundred different nerve fibres into action; ninety-five percent of fibres conducting are the same for the two notes.<sup>12</sup> The act of hearing is then an interplay of sub-acts, the impeding of any one of the sub-acts affects the total act of hearing.

Empathetic relations between acts is of vital importance in the development of sub-acts, which in their total progressive interplay may reach a feeling phase. Once acts reach a psychic phase they may be used as stimuli in communication and later in artistic projection. Empathy may be defined as

---

12. See Peter Nathan, The Nervous System, Chapter Four, pp.43-63.

an involuntary breach of individual separateness. Sometimes it does not even involve that breach but, contrariwise, is a stage in the loosening of a close bond, actual identity, as a parturition, where a new separateness, long prepared, begins. In animals it is probably a fluctuating, gradually fading intimacy of feeling that unites a parent animal and its brood for an indefinite yet transitory period of time. In human life, where conception and imagination pervade the whole fabric of sensory perception and its immediate uses, empathy is largely replaced by sympathy or some other semi-intellectual response. 13

The existence of empathy at the cellular level may be discussed in terms of homeostasis. Each living organism seeks constantly to maintain a host of physical and chemical inner 'steady states', the totality of which, in terms of the interplay of acts, is organic life itself. When physiological activities of outer environmental forces disturb the steady state; for example, if CO<sub>2</sub> level in the blood is raised due to the nature of the environmental air, then the body initiates an act to correct the disequilibrium towards the organically desired direction. A partial function of acts is to maintain the organisms homeostatic balance as a desired matrix for its life economy. The inductive or inhibitive influence of acts becomes ordered through empathetic homeostatic action. The flow of influence tends to be from the stronger to the weaker.

Homeostasis, long recognised as the source of 'steady states' under conditions of constant biochemical activity, has its analogue on the behavioral level in the interactions of impulses with their co-ordinated 'inhibitors' and 'releases' (inhibitors of the inhibitors). In organic behavior (breathing, peristalsis) inductor and inhibitor substances, which can evoke or block the muscular acts involved in each cycle, are fairly well known, even with respect to their origination in the body. In reflex action, specific stimuli and selectively responsive sensory organs, as well as many of the neural paths and plexus over which the stimulated impulses are conducted, have been found;... 14

In higher forms of animal behaviour those actions that are brought about through homeostasis are referred to as being 'instincts'.

- 
13. S.K. Langer; Mind: An Essay on Human Feeling, Vol. II, p.129.  
 14. S.K. Langer, Mind: An Essay on Human Feeling, Vol. II, p.17.

Empathy, which may be referred to as 'homeostasis' or as 'inhibitive and releasive factors', is a principle of organic life that assists in the entraining of other acts as well as in the development of sub-acts.

The third factor in the growth of acts, the energy of the original impulse which may be enhanced during actualisation, may be demonstrated in terms of the propagation of a nerve impulse. When a nerve impulse arrives at the axon membrane there is a margin of safety of approximately 5:1 above the firing point of the axon. Between a nerve ending and the next neuron is the synaptic cleft which may be from 200 to 300 Å wide. The excitability delivered across this gap, by means of chemical agents, must be sufficiently high to set off the post-synaptic neuron.

The amount of excitation needed to fire a neuron is different at different times. At one time a certain amount of excitation will fire it off; half a second later, this amount will merely raise its excitability. This is clearly seen in the case of the motoneurons working the respiratory muscles. These motoneurons show rhythmical changes in their potentials in phase with respiration. If some nerve impulses arrive at one of these motoneurons, they may or may not fire it off, depending on the phase it is in. If its excitability is already great, the arrival of a few more nerve impulses will have no effect. 15

An impulse from a specific area in the body may be increased, decreased or completely blocked. The manner in which initial impulses may be transformed is explained by Peter Nathan.

---

15. Peter Nathan, The Nervous System, p.110.



When a stimulus affects the skin, a burst of impulses is sent along the fastest conducting nerve fibres to go to various parts of the brain. The regions are alerted to further impulses coming in. The first neuron on the afferent pathway within the central nervous system can be inhibited by an inhibitory neuron under control from the brain; furthermore, this inhibitory neuron can also be made active by a branch of the incoming neuron itself. A simplified version of this scheme is shown in Figure 6.

- o ---      Inhibitory neuron
- o —        Excitatory neuron
- +          Excitation
- Inhibition

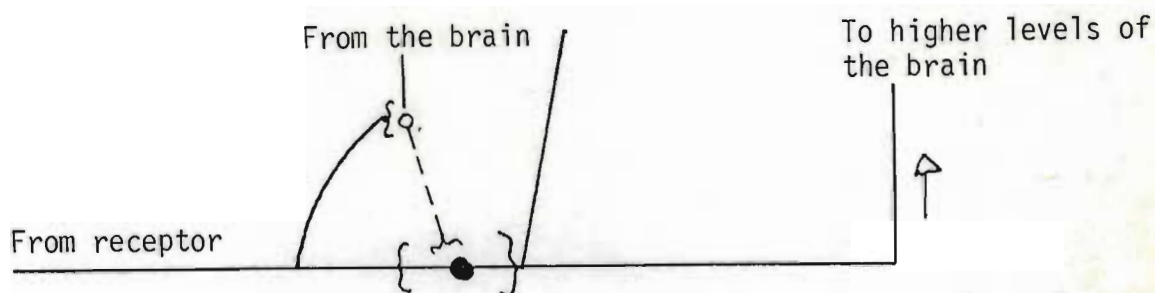

Fig. 6 Scheme showing the descending control of the input at the first synapse on an afferent pathway 16

Inhibition arranged in this way can be so effective that the incoming nerve impulses can be completely suppressed. There are also descending nerve fibres from the brain which keep the next neurons at the first synapse continually firing off impulses. When further impulses come in from the skin receptors, the amount of this activity can be doubled. This is a way of keeping the sensory systems always at the ready and sensitive to the changes occurring in the environment. 17

Within the complexity of acts going on within man there is a general move towards the self completion of action. An act, once initiated and supported by other sub-acts so that its rhythmic appearance are firmly established, has an innate potential for self completion. At the biological

16. Peter Nathan, The Nervous System, p.110.

17. Peter Nathan, The Nervous System, p.126.

level many acts reach their completion merely as a result of an initial impulse. This is illustrated in the experiments of Hammerling on the unicellular alga, *Acetabularia*. This green alga is a stalk which contains chloroplasts, and bears root-like rhizoids. *Acetabularia* has only one nucleus which is situated in one of the rhizoids. When the tip of the stalks forms an umbrella, the nucleus breaks down into daughter nuclei and cysts are formed. These cysts generate and form flagellated gametes which after mating differentiate into stalk and rhizoid.

In his experiment, Hammerling showed that anucleated stalks could survive for many months.

Moreover, an anucleated stalk is able to complete its normal ontogeny by forming a cap and to regenerate one new cap, provided a new growing tip has formed before the nucleus was removed. However, the new cap - in fact, the entire cell - is incapable of further regeneration. On the other hand cells containing a nucleus can regenerate a new cap repeatedly. 18

Ebert and Sussex conclude from the above that development in the anucleated stalk is a result of products synthesized earlier by the nucleus. This progressive flow of action along the stalk, even after the nucleus has been removed is a clear example of the self-completary ability. Development may take place even when the proper biological impulse has not been supplied, for example, the artificial activation of certain eggs in parthogenines. Frogs eggs may be artificially activated by pricking them with a needle dipped in frogs blood. Sea urchin eggs are stimulated by treating them with acids and rabbits eggs, by subjecting them to heat and shock.<sup>19</sup> These artificial

---

18. Ebert and Sussex, Interacting Systems in Development, p.151.

19. See Ebert and Sussex, Interacting Systems in Development, p.39.

stimulations set off a process that is normally initiated by the sperm.

This brings out another factor in act growth, namely, there is no clear one-to-one relationship between impulse and act. Once an act has been set in motion it creates an act pathway which facilitates repetition of that act. With constant use the act pathway (the structural arrangement of elements within the organism) is more easily used and the act may still be a characteristic of the individual long after the function of the act is needed by the organism.

The growth of acts is opportunistic. There is a continuous struggle for survival going on in the body. Inductive and inhibitive acts, both work towards realisation and it is through their rhythmic interplay that a homeostatic steady state is maintained in the body. Homeostasis is by no means passive. Any impactive stimuli from the environment has to contend with a violent clash of acts for supremacy in order to have influence. If the initial impulse of an impactive stimulus is strong enough (this is dependent on its temporal and spatial appearance and not only on its intensity) it will redirect or modify the flow of action going on in the organism. In a similar way impulsive stimuli (those that arise from the inner environment) may be influential in inducting, inhibiting or modifying the rhythmic interplay of acts.

Beside the basic principles of dynamic structure, there are also functional properties of a less pervasive sort that characterises the ever-growing activity of life on earth; occasional major changes in the implementing mechanisms of some acts, changes which arise from no single sequence of events, but from summations, convergences and (chiefly, perhaps) from over-development of successful functions that leads to excessive complication of structures and steps. Such eventualities beget crises in the existence of the stock that encounters them; but if it survives it usually makes an evolutionary advance, which may be spectacular. 20

The overall progression of man in terms of his development and learning has followed such an spectacular evolutionary leap. The phenomena of 'mind' shows man to be unique among all living organisms. Before discussing some of the simpler aspects of mind, it is important to follow a few of the acts which may be described in terms of the functions of the brain and how function may be related to consciousness. This will be the subject matter of the following chapter.

CHAPTER THREE.

THE ACT CONCEPT IN RELATION TO MAN.

The human brain may be anatomically divided in many ways. A simple method is to distinguish between the brain stem and the cerebral hemispheres. The brain stem incorporates the hind brain and the mid-brain. Above the spinal chord is the medulla oblongata followed by the pons, above which is the cerebellum. The medulla oblongata, the pons and the cerebellum, form the hind-brain. The mid-brain consists of passing nerve fibres which travel from the fore-brain to the medulla oblongata and the spinal chord. The fore-brain consists of the two cerebral hemispheres and the hypothalamus.

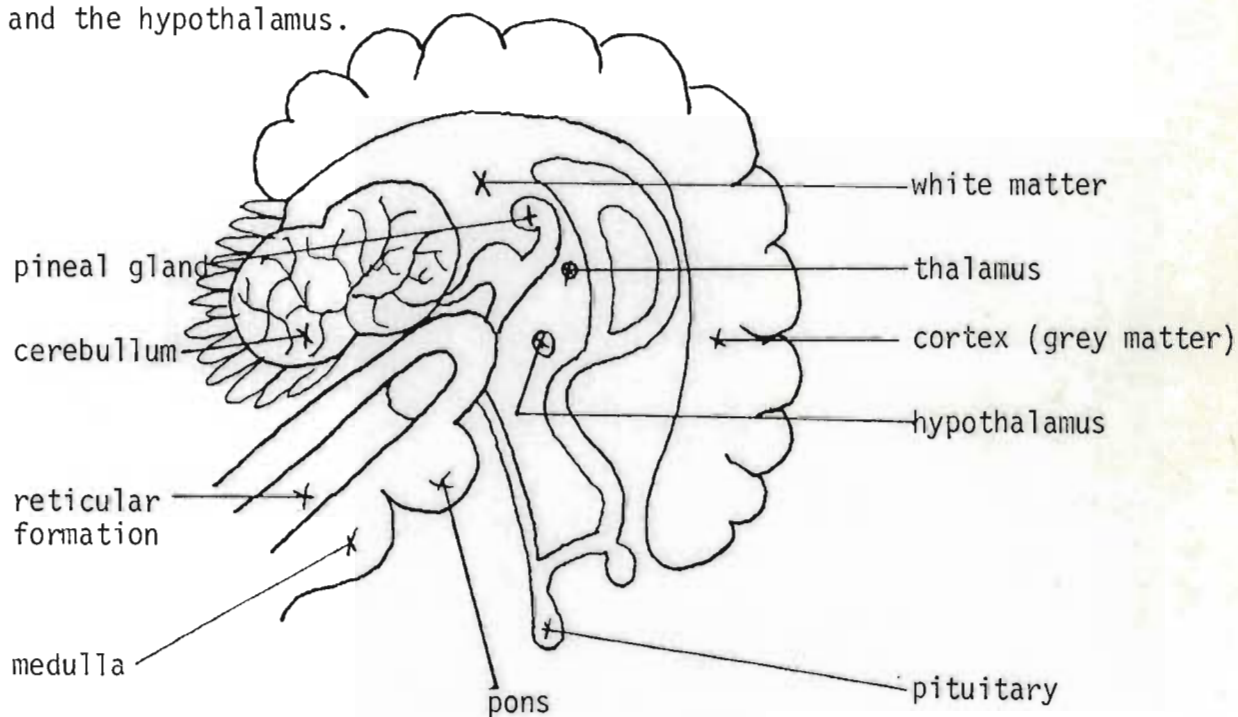

Fig. 7 Median section through the brain

Median section through the brain shows diagrammatically the major features of the human brain. The cerebrum is incompletely divided into two halves, each of which consists of a covering of grey matter. The most highly developed functions of the nervous system, such as remembering and intelligence, are dependent on the cerebrum. The thalamus processes signals from all the sensory systems. The mid-brain contains the major non-visual inputs and output pathways of the cerebrum. The cerebrum controls balance and the precision of voluntary movement. The medulla contains the lower centre for sensory and motor functions and with the hypothalamus controls heart and breathing rates and digestion. 1

The hind-brain is involved with those acts that have for the most part to do with the control of bodily functions, especially those of drinking and swallowing. These acts, essential for the life process, may be called 'old' in terms of the evolutionary development of man. The acts, which process, analyse and command the functions of the organisms of the body, generally occur in the hind-brain and in the mid-brain; those which are concerned with the external environment occur in the cerebral hemispheres. The cerebral hemispheres may be considered as the last intermediate neurons between the afferent and the efferent neurons. It allows for a vast amount of information, derived from the present state of acts within the body and from memory, to filter in between the input from the environment and the response along the afferent neurons. The interrelated activities of the cerebral hemispheres are extremely complex and it is generally agreed that they are the areas in which acts of consciousness occur. Consciousness may be described at a clinical level in terms of observable bodily movement phrases which are relayed to activities of specific areas within the brain. Consciousness is a qualitative concept

---

1. From the Human Brain; An Introduction by Donald Mackay, A selection of papers from The Science Journal, p.19.

which may only be described in terms of what is 'going on' in the body. It may not be described in terms of 'amount' of activity, although a cessation of movement is commonly thought of as a lack of consciousness. However, the movement that takes place during sleep (where there is a lack of waking consciousness) and the stillness of the body in meditation (heightened consciousness) deny a quantitative theory of consciousness. W.R. Russell in Brain, Memory and Learning (1959) has defined six qualitative activities related to consciousness.

- (a) simple reflex activity;
- (b) restless and purposeless movements;
- (c) purposeful movements but no speech or understanding of speech;
- (d) restless movements and the ability to utter a few words or phrases, often expositive;
- (e) uninhibited speech and action but disorientation and amnesia for current events; and
- (f) full orientation and social decorum. <sup>2</sup>

Although the above categories shade into one another there seems to be a confusion between a developmental qualitative and a developmental quantitative analysis; (a) presumably displays less consciousness than (f). An interesting factor, however, is the importance of speech as a behavioural act culminating in 'social decorum'. Speech is the unique speciality of the human being. As Lynn White has written

We are beginning to see that the distinctive thing about human species is that we are a symbol-making animal, homo signifex, and that without this function we could never have become sapiens. We have not only the capacity to make symbols: we are under the necessity to create them in order to cope humanely with our experience. <sup>3</sup>

Thus, in order to avoid the qualitative/quantitative dilemma of Russell's

---

2. As quoted in Brain Damage and the Mind by Moyra Williams, p.15.

3. Lynn White Jr., Frontiers of Knowledge in Study of Man, p.305.

clinical definition of levels of consciousness, consciousness will be described as the ability to create, hold, think and comprehend symbols. The use of symbols whether movement, verbal or artistic, was the beginning of man's developmental process in humanisation. In man there is a development from perception, to attention, to memory. Memory is the ability to envisage and to think of a symbol again and again.

The most elementary sort of memory, giving rise to what Bertrand Russell many decades ago, called 'knowledge by acquaintance' is formed on a cerebral function which has been little understood so far, in physiological terms, but has recently received a suggestive sidelight from an experimental study in animal neurology, which reveals something of the mechanism whereby an act of perception, when stimulated by one object or motion, automatically isolates its stimulus from rival impingements. Such concentration of vision, hearing, smell or any senses together on one stimulus may be supposed, then to occur without any added voluntary act of 'paying attention', it is the act of attention itself, and takes place in some way at least wherever there is a forebrain to guide animal behavior. In man, however, it incidentally provides a 'servomechanism' for another evolving function, for it abstracts a percept from the whole sensuous array, and this percept promptly takes the character of an image, without requiring much spontaneous imagination. Very soon ... the percept is a hybrid of sense impressions and dreamlike images; and it is probably in this state that it is remembered and recognised, at least in infancy. 4

The hybrid sense percept is a result of the interplay of many factors. One of the most important being the filtering process of incoming information to the brain. The 'all or nothing' firing principle of the nerve cells and the action of synaptic inhibition are some of the means whereby selected sense impressions, images or emotional feelings become heightened, realised or felt. When efferent neural activity is enriched with memory it may excite different parts of the brain or the whole brain in a new way. For example, a stimulus which may wake a doctor is

---

4. S.K. Langer, Mind: An Essay on Human Feeling, Vol. II, pp.340-341.



different from a stimulus which may wake a mother. For the doctor it may be the telephone, for the mother, her child crying. These different stimuli, which become acts of sensation, are felt as impact only when they enter the inter-play of the individual's rhythmic mode of acts in such a way that they disturb the established rhythm. For example, the noise of the traffic will not wake the doctor or the mother if they have lived in an urban area for some time.

Frequently memories, not sensations, constitute the scanned material. They are recomposed, re-valuated and redeposited on the neural protein.<sup>5</sup> Simultaneously, the scanned memories elaborate feeling tones, and they will in turn be elaborated upon by the new feelings. The inter-play is so intimate that if the words 'thought' or 'emotion' were given to this process they would be incorrect - it is an inseparable fusion of the two.<sup>6</sup>

The complex interaction has further ramifications. The ongoing thinking-feeling process modifies and is modified by the body. Discharges down the autonomic nervous system appropriately alter the diameter of the blood vessels, the rhythm of the heart the cardiac of breathing. Reciprocal feedbacks from the tissues to the brain cause readjustments of the level of alertness and the emotion-thought complex.

The emotion thought complex may be thought of as having three potentials, all of which are extremely complicated, and which in the adult human being are entrained with each other. These three potentials may be described as (1) acts of sensation; (2) acts of emotion; and

---

5. The theory of 'neuronal protein' action in memory is, as far as I know, still at the hypothetical level. Holger Hyden's biochemical theory of memory is based on modification of the structure of ribonucleic acid by the incoming message. The RNA is discharged into the cytoplasm and a memory protein is then produced. Recall is achieved by the 'restimulation of the neuron which causes the protein to break down and the neuron to fire'.

(3) acts of thought. The transitional stages are not clearly marked between the different qualities of acts and it is usual that sensations, emotion and thought are all present as either inhibition or induction in one super-act, i.e. that of feeling. In the phenomena known as 'synaesthesia' which is the crossing over of sensation from one sense modality (e.g. hearing) to another (e.g. vision) synaptic inhibition seems to be reduced and the sensory excitation flows into those circuits from which it is normally inhibited.<sup>7</sup> This points to the fact that within acts of sensation alone there are numerous inhibitive and inductive processes going on. Normally the act which is rising to a peak of excitement is effective as an inhibitor to those acts that are lower down on the excitory curve. For example, H. Hyden has demonstrated in experiments with low and high activity of the brain, that glia cells and nerve cells form a coupled system. The nerve cells have a greater potential for the absorption of energy coming from the respiratory chain than do glia cells. Thus during increased brain activity the glia cells are inhibited in their rate of activity. 'Low activity in the nerve cell contrasted with high activity in the glia cells and vice versa. Such a coupled system would, from a kybernetic point of view, provide a considerable stability.'<sup>8</sup>

On the other hand it is possible to describe acts that induce lesser acts to develop. When 'emotion-producing' stimuli were presented to a subject in experiments there was an increase in brain activity which was correlated with an increased production of RNA and protein.<sup>9</sup> Some

---

7. See Dr. Cohen, Drugs of Hallucination, Chapter 4, pp.45-57 and p.40.

8. H. Hyden, Biochemical Aspects of Brain Activity - from Memory Mechanisms, edited by K.H. Pribram, p.45.

9. See H. Hyden in J. Brachet and A. Mirsky The Cell, Chapter 5.

biologists have asked whether the flow of inductive acts from perception, to increased brain activity, to increased RNA and protein production, may be reversed. That is, a change in protein and RNA may induce a change in perception.

In considering the problem of control of the mind, one finds that these data give rise to the following question: would it be possible to change a fundamental of the emotion and the subjective experience of emotion-producing stimuli by inducing molecular changes in the biological active substances of the brain? The RNA, in particular, is the main target for such a speculation, since a molecular change of the RNA may lead to a change in the protein being formed. 10

Rather than considering the reversal of the natural flow of inductive acts in terms of mind control, the possibility of utilising the natural flow in terms of the possible regenerative effects of bodily activity on the brain function will be considered in a later chapter. The function of bodily movement in increasing an overall potential of the mind in acts of creativity has an extremely important role in education and the perception of reality. It has been shown that for the central nervous system and the brain to function in terms of a mental concept of reality, constant neural activity through impactive sensations and the necessary effect of gravity must be present. In experiments by Hebb (D.O.Hebb, Sensory Deprivation, Harvard University Press, 1961) and his associates to test the effects of sensory deprivation on man, the subject is immersed in a tank of warm water, he wears a special suit and a diving helmet. The usual supply of visual and auditory stimulation is also cut off. He experiences nothing, feels relaxed and usually goes to sleep. When he wakes up his thoughts flow in repetitive circles and then become chaotic. He loses his orientation and hallucinations occur.<sup>11</sup>

---

10. H. Hyden, Biochemical Aspects of Brain Activity, from Memory Mechanisms, Ed. K. Pribram, p.48.

11. H. Hyden, Biochemical Aspects of Brain Activity, from Memory Mechanisms, Rd. K. Pribaum, p.42.

The above experiments have, on the positive side, shown the importance of the interrelations that exist between bodily acts and those of the mind. It shows that observable movement of the body has a microscopic phase of activity. Acts have also been shown to induce or inhibit other acts at different phases of movement. Thus action may inhibit or induce thought or vice versa, as both are of the same nature. This nature is made clear by the 'act concept'. Memory may no longer be considered to be a property of mind but a functional act of mind. Similarly it will be shown that creativity is not 'something' or a property of mind but a functional act of mind. Similarly it will be shown that creativity is not 'something' or a property that certain individuals have in increased or decreased quantities.

In order for memory traces to be fixed, a certain amount of time has to elapse. The experiments of Herman Ebbinghaus (1850 - 1909) have shown among other results, that as the amount of material to be remembered increases, learning time also increases but at a disproportionate rate. That is, it would take more than twice the time to remember twenty items as it does to remember ten. '... it is generally true to say that the more there is of any material for memorising, the more time will memorising take, and if the amount is doubled or trebled it will take more than twice or three times as long for memorising'.<sup>12</sup> This follows the temporal nature of acts. Further investigation by Ebbinghaus and later by W. Kruger and others have shown that in order for memory to be fixed, a potential optimum time of learning has to elapse. Kruger, using three groups of adults, asked his subjects to learn a list of twelve

---

12. Ian Hunter, Memory, p.133.

unrelated nouns. The first group repeated the learning process until they accomplished their first errorless account of the nouns, the second group continued to learn for half the number of times again after this point had been reached, and the third group re-learnt by as many times as they took to reach a perfect run through of the vowels. After twenty-eight days, each subject re-learnt the list giving both recall and score and a saving score.

The results are shown in the table :

	Group		
	I	II	III
Saving after 1 day	21,7%	23,2%	47,1%
Saving after 28 days	1,5%	20,5%	25,1%
Words recalled after 1 day	3,1%	4,6%	5,8%
Words recalled after 28 days	0,0	0,3%	0,4

This data shows that the amount remembered increases with an increase in the number of learning trials. But increasing this number ten to fifteen results in greater improvement than increasing the number from fifteen to twenty. 13

From the above it would seem that the act of remembering in this way, has an optimal value in terms of repetition and length of time. As to whether the scanning and learning of nouns really supplies any real knowledge of memory is open to question. It seems that these experiments do not substantially contribute towards a theory of memory in that it approaches memory as a fixed function of the brain. However, it is discussed here as a possible example of optimal time values in specific acts within certain circumstances.

The laboratory experiments of electric stimulation of a muscle removed from a frog's leg gives another example of optimal rhythmic action.

The contraction of this muscle, which is registered graphically on a moving drum, is sufficient to lift a tiny weight. When the weight begins to drop, if the muscle is at once rested and bathed in salty water, it will 'come back' quickly, perhaps requiring five minutes rest before it can begin to contract upon stimulus, and again lift the weight. If however, instead of stopping the work when there is a reduction in the power of the contractions and the muscle is kept under stimulus and made to work longer, the registered curve will drop quickly until it disappears; that is, until the muscle stops contracting. Now it will take, not five minutes, but at least twenty-five, or an amount of rest equal to the square of the first period. 14

This concept of optimal temporality of acts is important in the consideration of the human individual. It will be seen that an aspect of the individual may be considered as unique through an analysis of his range of the internalisation of time in action. Works of art will also be shown to involve a projection in terms of symbols of the artist's conceived temporal action. This will be dealt with in a later chapter.

Induction may be defined biochemically as 'a chemical conversation ... between the intrinsic determining mechanisms of the morphogenetic field (or its already independent differentiated parts) and the extrinsic organising properties which guide its flowering'.<sup>15</sup> This definition is important in realising the nature of the relationship between acts of induction. Research in experimental embryology has given evidence that induction does not merely progress through a 'trigger response' mechanism. For example, the head skin, which normally forms a lens in the eye was shown by transplantation experiments to be polypotential. In other words, head skin was capable of joining with ear skin and to be induced to form an ear. However, once induction has occurred and the act has begun, induction

---

14. Mabel Todd, The Thinking Body, p.63.

15. K.H. Pribram, 'Some dimensions of remembering: Steps towards a Neuropsychological Model of Memory'. from Memory Mechanism, p.289.

will no longer have the same effect

... the reacting system, must be ready or 'competent', i.e. in the proper state of responsiveness, to allow induction to become effective, e.g. tissue which is already launched, as it were, toward a different destination will fail entirely to respond. 16

In the consideration of agents of induction it has been noted that these are not species specific. Inductors may be effective on tissues which are of a different species, genus or order. Examples of the above were given in Chapter 2, i.e. the artificial induction of the embryo in the development of the frog and other species. The above aspects of induction may be summed up, in embryo-genetic terms, in the following statement. The development of the embryo 'is dependent not only on the inherited and inherent properties of the genetic constitution of the organism; rather, these properties are also evoked and organised by the inductive capacity of the milieu in which the cells grow'.<sup>17</sup>

As a general principle of induction this may be applied to all phases of acts. Bodily movement may, provided that other 'reacting systems' or acts are 'competent', induce change in the other phases of acts. The influence of acts on the organisation of their agents seems to be a real possibility as is shown in the following example.

Although nerve cells in the brain do not reproduce, they are however, capable of extending their branches. In a histological study of the injured area of the brain, intact nerve cells sent branches

---

16. K.H. Pribram, 'Some Dimensions of Remembering : Steps towards a Neuropsychological Model of Memory' from Memory Mechanism, p.290.

17. See K.H. Pribram, The New Neurology : Memory, Novelty, Thought and Choice, p.60.

into injured areas. During their growth they became more and more organised until the damaged tissue had been repaired. It is hypothesised that glia cells, which surround the branches of the nerve cells, guide the organisation. Whereas nerve cells do not reproduce, glia cells do, and it is likely that their cell division is spurred by the same activities as those that are important to memory storage and memory excitation. These activities, then, induce glia cells and particularly Schwann cells, through cell division, to form a column through which the nerve fibres grow. Thus the growth of nerve fibres is directed in part by its own excitation. Jacques Monod in *Le Hasard et le Necessite*,<sup>18</sup> has said that it is likely that the evolution of human cortical structures was influenced by the early acquisition of a linguistic capacity, so that articulated language

not only has permitted the evolution of culture, but has contributed in a decisive fashion to the physical evolution of man, and there is no paradox in supposing that the linguistic capacity that reveals itself in the course of the epigenetic development of the brain is now a part of 'human nature', itself intimately associated with other aspects of cognitive function which may in fact have evolved in a specific way by virtue of the early use of articulated language. 19

This inductive view of language, both on the human brain and on other cognitive functions seems to have a likely biological foundation. The flow of action through agents has a modifying effect, and the condition for modification is in the competence or readiness of the 'agents'. This is determined by history and by genetic structure (which in itself is influenced by biological evolution). Acts become organised through the interplay of initially given biological structures of the brain

---

18. See S.K. Langer, Mind : An Essay on Human Feeling, Vol. I, p.412.

19. S.K. Langer, Mind: An Essay on Human Feeling, Vol. II, p.332.



maturational processes (DNA guidance) and the interaction of the organism with the environment. In this way acts become specific in function. Furthermore, the continual flow of action has the effect of modifying those agents involved in specific functions.

The evolution of 'mind', as distinct from brain, may be postulated as arising from random acts becoming organised through evolutionary and environmental interplay. This random throwing about hardly seems likely to bring about the complexities of mind. However, it must be remembered that acts, although random, have a propensity for completion and that they develop into a self-continuing system that becomes involved with other acts.

They become very intimately involved with their own subacts and with superacts into which they themselves enter, and not much less so with acts to which they stand in some relation - active or passive - of induction. The wider relationships that compose the basic dynamism of life, and are all subsumed under 'motivation', probably hold in one direction or other between any acts belonging to the same organism. 20

Progressive involvement together with the opportunistic flow toward completion (itself probably conducive to involvement) provides for an organisation principal and for individuation.

Language has been studied in order to discover some similarities between its structure and that of the mind. Naom Chomsky's theory of 'structure-dependent operations' arises out of the formal operations in the grammar of the English language and other western languages. He argues that 'structure-dependent-operations' are part of an innate schematism applied by the mind to experience. He applies this innateness to mind in

the Cartesian sense, that is, man innately possesses the idea of geometrical construction. Furthermore, Chomsky points towards neurophysiological structure as the schemata for the interpretation of the experience of figures and objects.<sup>21</sup> The principles underlying grammar are so specific, he argues, that they are genetically determined. The 'substantive universals' (the constructive features of phonology, syntax and semantics) are to be found in all languages. In developing a concept of mind, it is language that most distinguishes the mind of man. Language is the projection of images through the media of speech. That language should have an innate constructional foundation based on genetics and nurtured during maturation through environmental experience seems extremely likely, although an empirical investigation of the structural similarities of many languages has not, as yet, been described in any great depth. The value of Chomsky's theory is that it brings the opposition of body and mind into a new relationship. Both 'instincts' and 'environment' play their part. The dialectic interplay of these two influences, which may be felt as either impulsive or impactive, is brought about through many phases of acts.

Speech arose, as Langer suggests, in the 'high reaches of proto-human activity'.<sup>22</sup> 'The great individuation made by subjective activity, the symbolic finishing of excessive nervous impulses within the nervous system itself, breaks the system of instinctive responses (of animals) and begets the first processes of ideation'.<sup>23</sup>

Undoubted language is the most commonly used form in which the projection of subjectivity is achieved. It is also, probably, the most defined means of

---

21. See Naom Chomsky, Problems of Knowledge and Freedom, p.31.

22. S.K. Langer, Mind: An Essay on Human Feeling, Vol. II, p.314.

23. S.K. Langer, Mind: An Essay on Human Feeling, Vol. II, p.314.

ideation and communication. However, mind may also be involved with visual, auditory and kinaesthetic imagery. To some extent language reflects this involvement.

To view language solely as a communicative signalling device is to see only a partial aspect of the function of language. The formative power of language is an additional value and is a prior condition for communication. The formulative processes of speech have been extensively discussed by Ernst Cassirer. In his work 'The Philosophy of Symbolic Form' (Volume One) he shows how language shapes man's percepts, how it is able to bring separate objects and events together in thought, and how through language the human being's ambient becomes a world. However, in order to find a clear involvement with visual, auditory, tactile and kinaesthetic processes, it is necessary to shift one's focus from language to speech. It is impossible to talk of an act of language but it is possible to talk of an act of speech. It is in vocalisation and speech that strong biological foundations may be discovered.

In terms of the brain structure it has been ascertained that there is a unique asymmetry in the upper surfaces of the right and left temporal lobes.

The planum temporale is larger on the left in 65 per cent of brains; on the right it is larger in only 11 per cent. The left planum is on the average one-third larger than the right planum. This area makes up part of the temporal speech cortex. 24

This asymmetry was discovered to be present in newly born babies, a fact which substantiates the theory that acts involve and modify agents through an evolutionary process. In the case of speech the left planum in right

---

24. Norman Geschevind and Walter Levitsky, 'Human Brain: Left-Right Asymmetries in Temporal Speech Region', p.186 as quoted by Langer, Mind: An Essay on Human Feeling, Vol. II, p. 327.

handed individuals and the right planum in the case of left-handed individuals has become enlarged. (The indirect relationship between handedness and complex language functions has been noted by authors such as Lord Brain in a lecture entitled 'Speech and Handedness'.)<sup>25</sup>

The babbling of babies has been noted to extend beyond the range of the mother tongue and it is only after maturation of speech that the range of sounds is limited to those that the child needs for his language. Therefore the innate biogenetic foundation for vocalisation and sounds used in speech is a possibility. The elements of pitch range, tone and rate of articulation are all qualities of speech that are involved with feeling, and feeling involves the interplay of acts. Language with its functions of organisation and communication modifies qualities of speech that are involved with feeling, and feeling involves the interplay of acts. Language with its functions of organisation and communication modifies qualities of feeling which are all part of the 'life of mind'.

The dialectic which makes up that life is a real and constant cerebral process, the interplay between the two fundamental types of feeling, peripheral impact and autonomous action, or objective and subjective feeling. As fast as objective impingements strike our senses they become emotionally tinged and subjectified; and in a symbol-making brain like ours, every internal feeling tends to issue in a symbol which gives it an objective status, even if only transiently. This is the hominid specialty that makes the gulf between man and beast, without unbiological addition, and probably goes back as far as any possible division between our kind and other primates. 26

---

25. See W.R. Brain, 'Speech and Handedness', *Lancet* II (1945), p.837.

26. S.K. Langer, Mind: An Essay on Human Feeling, Vol. II, p.342.

CHAPTER FOUR

THE APPLICATION OF THE ACT TO  
HUMAN MOVEMENT

It is now necessary to discuss the movement of the human body and how space and time become internalised in these acts. It has been shown how action at the molecular and cellular level may be thought of as processes of induction and inhibition of acts. It has also been shown that these processes involve the agents caught up in the act and that the species may become modified during long evolutionary processes as a result of the modification of the organism. The processes of induction and inhibition are still relevant in a discussion of the movement of the human body but it is necessary to define the individual and to limit the area of discussion to that which has relevance to bodily movement.

H.B. Redfern has scrutinised the meaning of the word 'effort',<sup>1</sup> as used by Laban,<sup>2</sup> in her book Concepts of Modern Educational Dance (1973). She has pointed out that Laban has used the word 'effort' in relation to different aspects of the individual, that is, he speaks of 'mental effort',<sup>3</sup> and of effort as an 'inner impulse'.<sup>4</sup>

As a result there is confusion as to what is exactly meant by 'effort'. This is clearly discussed by Redfern and will not be dealt with in detail here again. This chapter will focus on the relationship of effort to the individual and in this way attempt a further clarification of the meaning of 'effort'. The confusion about 'effort' is partly due to the subject-predicate nature of language in which self identical

- 
1. See R. Laban and Lawrence, defined in Effort.
  2. R. Laban, Founder of Kinetography or Labanotation.
  3. See R. Laban, Mastery of Movement, p. 13 and p.85.
  4. See R. Laban, Mastery of Movement, pp. 15, 24 and 85.

objects, for example, human beings, may be seen with various properties and qualities which have a potential for change. If the bearer of these properties and qualities of effort changes then the meaning of the qualities becomes confused. The bearer must then be defined. Furthermore, the western languages are structured in such a way that the principle concepts are those objects designated by nouns and as words they become fixed objects of experience. Nouns are further qualified by adjectives and related to each other by verbs. This structural framework confuses our concept of 'effort', for when it is used as a noun, 'effort' becomes a fixed concept of experience. In fact it becomes a 'property' which may be further elaborated by adjectives or adjectival phrases: such as 'effort' which is expressed in terms of 'flexibility', 'directness', 'sustainment', suddenness', 'fine touch' and 'weightiness' or 'strength'.<sup>5</sup> As such the properties of 'effort' have qualities; if the property is removed or becomes confused, as Redfern has suggested it is in the writings of Laban, then the qualities lose their meaning. As a noun 'effort' may be related to other nouns, hence 'The impulse given to our nerves and muscles, which move the joints of our limbs originates in inner effort.'<sup>6</sup> Because of the noun relationships, there is a tendency to regard 'impulse' and 'inner effort' as fixed properties of experience and therefore other relationships of 'effort' to 'mind', 'moods' and 'drives' may be erroneously made. Thus it is clear, that effort is not a 'property' or an item of our fixed experience and, therefore, it may not be classified within the noun category.

In order to have a clear notion of what effort may involve, it is necessary to see it as an act process in relation to the individual. It

---

5. See R. Laban, Master of Movement, p.78.

6. R. Laban, Mastery of Movement, pp. 83-84.

has already been pointed out that the individual is not synonymous with organism. The individual in this way has meaning in the sense of an organism's individuation and involvement.<sup>7</sup> These two principles underlie all organic growth and are intimately involved with each other in that there could be no involvement without there being individuation and hence individuals. Similarly there can be no individuation without the involvement of acts and organic elements or agents. When referring to man the individual has no fixed denotation. It may be used to identify one person from another or it may be used in the sense that 'John is more of an individual than Charles' - here obviously referring to some quantitative assessment. It may also be used to imply 'the self', the imagination, creative ability and a host of other things, for example, 'that dance reflects the choreographer's individuality'. The specific meaning of 'individual' when applied to a man within a movement context will here be taken as the unique interplay of the inductive and inhibitive nature of movement acts on other acts. This includes the interplay of feeling felt as 'peripherally impactive' and feeling felt as 'centrally produced' (impulsive). This concept of the individual when discussing movement will involve a consideration of the phased nature of acts. All movement acts do not reflect feeling directly but they may internalise feeling within the action. Similarly 'mind' may or may not be internalised in acting.

The kind of action in which the mind is generally not involved is that of 'reflex actions'. The term 'reflex action' is based primarily on the stimulus-response concept. If one stands on a sharp tack, one reflexively balances on the other foot. There is some empirical evidence

---

7. See S.K. Langer, Mind: An Essay on Human Feeling, Vol. I, Chapter 9, pp. 307-356.

that this action is reflexive in the sense that the nerve impulse is short-circuited via a reflex arc. It is true to say that on treading on the tack, one does not think or say to oneself that 'I have stood on something sharp which gives me a painful sensation in my left leg and therefore I must balance on my right foot'. If the involvement of mind implies directing or motivating one's action then it is true that reflex action does not involve mind. In order to discover if this may be legitimately postulated, it is necessary to review the 'stimulus-response' concept as well as to discover if thought or silent speech is a necessary condition for the postulation of mind. Furthermore, in what relation does 'effort' stand to the action of balancing on one's right leg ?

It is generally agreed that the stimulus-response theory does not confine itself to what may be called 'a straight line sequential event'. The cause of the individual standing on one leg may be argued abstractly.

1. If B cannot happen unless A exists, then it is legitimate to say that A is the cause of B. However,
2. A may be a link in any chain of causes which results in B, or
3. A may not be a link in any such chain of causation but may be a necessary accompaniment or sequent of causation that does result in B.

The first possibility may be represented diagrammatically :



1. A \_\_\_\_\_ B.

The second

2.  $A_0$  \_\_\_\_\_ A \_\_\_\_\_  $A_1$  \_\_\_\_\_  $A_2$  \_\_\_\_\_  $A_3$  \_\_\_\_\_ B.

and the third,

3.  $A_0$  \_\_\_\_\_  $\overset{A}{a}$  \_\_\_\_\_  $A_1$  \_\_\_\_\_  $A_2$  \_\_\_\_\_  $A_3$  \_\_\_\_\_ B.

The third statement could also take the form :

A

$A_0$  \_\_\_\_\_ a \_\_\_\_\_  $A_1$  \_\_\_\_\_  $A_2$  \_\_\_\_\_  $A_3$  \_\_\_\_\_ B.

Evidently, if B cannot happen unless 'a' precedes, and if 'a' cannot happen without B accompanying or immediately following it, B will not be able to happen unless A precedes it. And yet A will have no part in causing B. 8

Using Broad's argument and applying this to the case of the individual standing on one leg, it is possible to assume that A is the sensation of being pricked in the left foot. In this case it is likely that the event will follow the second sequence above where  $A_0$ ,  $A_1$ ,  $A_2$  and  $A_3$  are other necessary acts.  $A_0$  being the condition or readiness of the body for action and A,  $A_1$ ,  $A_2$  and  $A_3$  being necessary acts prior to balancing on the right leg, B. One of these acts may be the realisation by 'mind' of being pricked in the left foot. If 'mind' involves internal speech or thought as a necessary act in its role of involvement, then 'mind' is not a part of the sequence since internal speech did not occur in balancing on one leg. However, we may postulate that mind is represented by A in the third sequence. That is, it is a necessary event but is itself not directly a cause of B. In other words the realisation by the mind of the pain in the left foot does not directly influence balancing on the right foot, but it is a necessary accompaniment to the causal sequence.

---

8. C.D. Broad, The Mind and its Place in Nature, p.116.

This seems to be much more likely since after having pricked the left foot one is not surprised at balancing on the right. That is, the mind has accompanied the action and furthermore the cause of the mental state is that of a painful sensation. Now, if 'effort' is to be a technical term relating to movement only and not 'an externalisation of inner capacities' (these capacities being taken as mental ones), then, how does 'effort' relate to mind in the above causal sequence? As a technical term used in the description of movement, 'effort' may be described as the internalised factors of space, time, force and flow. These motion factors give rise to the observable qualities of flexibility or directness, sustainment or suddenness, fine touch or firmness and free or bound progression. It may be suggested that the action in the above example was a sudden, strong and bound transference of the centre of gravity on to the right foot. This is a legitimate description of an action. However, the sensation one feels, that is the subjective nature of the experience, is also something which accompanies the act. Besides the sensation of pain, one also experiences the kinaesthetic sensation of movement, which is of a particular kind. In what way, then, is the description of a sudden, strong and bound action relevant to my subjective experience of movement?

If actions are thought of as being part of an objectifying process and sensations as being part of subjective experience then the confusion of body/mind dualism existing in this proposed statement concerning movement, emerges. It is reasonable to postulate that not all movement of the body is a process of objectification, that is, all movement is not necessarily a projection.

Is it impossible that human movement can exist purely as movement for projection?

In Chapter 3 of this thesis, Langer has been quoted as saying 'As fast as objective impingements strike our senses they become emotionally tinged and subjectified, and in a symbol-making brain like ours, every internal feeling tends to issue in a symbol which gives it an objective status, even if only transiently.'<sup>9</sup>

What is being implied here is that the kinaesthetic sensations of movement in man reach a phase of kinaesthetic imagery. This image is not necessarily a picture image but is more likely to be a felt dynamic progression of, in its simplest form, an impulse, a development and a dying down. Kinaesthetic imagery, then, does not involve representational imagery, although it may become interpreted in terms of verbal and/or symbolic images, for example, kinetography. Piaget, in his experiments on the child's conception of movement and speed has shown that order is deduced from the child's own actions. His discovery is important here in that it shows a progressive development from kinaesthetic sensations to conceptualisation, as well as pointing to the nature of kinaesthetic imagery as being one of felt order.

... experiments of order (number, space), are experiments the subject really makes on himself, i.e. on his own actions and not on the objects, as such, to which his actions simply are applied. That is why these actions once co-ordinated into coherent 'groupings' may at a given moment dispense with any experiment and give rise to an internal and purely deductive composition, which would be inexplicable if the initial experience had consisted of extracting the knowledge from the objects themselves. This is the explanation of the fact that the concept of order, ... has an origin at once experimental but not empirical, since it results from experiments the subject makes on his own actions, leading to deductions at once, necessary and not a priori, it being essential to achieve the composition of these actions and not given from the outset. 10

---

9. S.K.Langer, Mind: An Essay in Human Feeling, Vol. II, p.342.

10. J. Piaget, The Child's Conception of Movement and Speed, p.36.

The muscles of the human body are sources of sensory impressions. Muscular activity produces kinaesthetic imagery as a necessary sequent. The image-making capabilities of man in his evolutionary development has become such a necessary accompaniment to his life style that it has pervaded all acts of perception and movement. Not all images are realised in action or are overtly carried out. Those acts of perception and stimulation which are not realised in overt action, are held and are probably completed in sleep.<sup>11</sup> The notion of 'effort' and 'spatial sequence', therefore, must extend beyond a technical application of the word in terms of a sheer description of movement to include the factors of image-making whether kinaesthetic, pictorial or symbolic. This Laban has attempted to do. His analysis of effort is broken down into efforts, attitudes, moods and drives.<sup>12</sup> All these words indicate a psychic and psychological awareness. Furthermore, he has stated that

It cannot be stressed too strongly that the movements the child experiences have a marked reaction on his mind, so that varying emotions can be induced through his actions... . 13 (1948)

(and)

The impact of movement on the mind has been studied, and it has been found that movement consists of elements which create actions reflecting the inner efforts underlying them. 14 (1948).

Laban implies some sort of causal relationship between movement, and mood, emotion and drives. Redfern has criticised this causal relationship. She says :

- 
11. S.K. Langer, Mind: An Essay in Human Feeling, Vol. II, p.277.
  12. R. Laban, Mastery of Movement, pp.76-86.
  13. R. Laban, as quoted by H.B. Redfern in Concepts in Modern Educational Dance, p.92.

We have also to realise that there are no exactly specifiable manifestations of every emotion. As Osborne (1968) points out : 'Darwin himself admitted that the varieties of expression are not adequate to discriminate the varieties of emotion known to popular wisdom and enshrined in common knowledge... . Anger and indignation differ from rage only in degree, and there is no marked distinction in their characteristic signs ... . Extreme contempt hardly differ from disgust.' And in Laban's classification, though it is of a wholly different kind, not dealing with movements such as frowning or dilating the nostrils, there is no demonstration of a one-to-one correspondence between a specific emotion and specific structures of movement elements. Moreover, many kinds of expression of feeling are governed by social convention and cultural tradition. 15

The confusion in this criticism lies in regarding emotion as a state. The words 'anger', 'indignation' and 'a specific emotion' are used in such a way as to denote some specific item of experience which is essentially fluid. Words to describe emotion such as 'hate', 'love', 'compassion' and so on, are as much of an abstraction from a dynamic process as are elements of effort. In order to make some sort of relationship between emotion words and 'element of effort' it is necessary to discover whether these two abstractions belong to the same category of knowledge or not.

Furthermore, it is necessary to point out again that although Laban does suggest a one-to-one casual relationship between specific kinaesthetic experiences and specific elements of movement, for example 'fine touch gives rise to an inner feeling of bouyancy' it does not necessarily invalidate the hypothesis of there being some sort of relationship by refuting the one-to-one relationship.

In fact, what is being described when one uses the terms 'emotion' and 'inner state' ? Redfern argues that we may not know or have knowledge of another person's inner state or emotion by only observing that person's movement. She says :

An emotional state is identified typically by reference to the circumstances to which it is related, it is not to be equated with a bodily state, or movement as such, even though there is, of course, a close relation between the two. 16

Emotion, then, is only emotion when behaviour is seen within its total environmental and social framework. If behaviour, without this reference, is not emotion, what is it ?

Firstly, it has already been established that all human movement is accompanied by some sort of image process. This process may not have a one-to-one relationship with a particular movement phrase, but is a necessary sequent to the movement. The nature and kind of image is dependent on the general tonus of the body organism in terms of acts, and the individual's spatial and temporal relationship with his environment. Secondly, no movement may take place without there being an object environment and/or a social environment. In relating movement to emotion, and in order to keep both observations within the same category of knowledge, it is necessary to observe movement within its total situation and to regard emotion not as states labelled by words but as acts of feeling which have risen to a conscious level. Emotion, far from being on the other end of a continuum from mind, becomes closely associated with mind. Thus a study of movement, like behaviour must incorporate, not only object and social environments but must also include a consideration of feeling, emotion, mind and belief. 'Effort' with its notational vocabulary, Laban's greatest contribution to the aesthetic description of the composition of movement forms, must be seen not as a description of feeling and mind but as a means by which the symbolic import of

---

16. H.B. Redfern, Concepts in Modern Educational Dance, p.91.

movement, especially in its art forms, may be brought to an analytical and discursive level without destroying the interplay of movement acts on each other. Effort notation also allows for other act concepts namely those of feeling and mind to become sequents within the framework. Laban's model of the 'effort cube' and the 'icosohedron', whilst appropriate to a discussion of movement, may only have an analogous value in the fields of psychological inquiry into emotion and philosophical hypotheses of mind.

In order to create a basis on which to structure knowledge of feeling/mind and movement, it is necessary to review the relationship between organism and function. Any function of the moving body has a trophic influence on the performing structure. This becomes clear in an evolutionary study of behaviour. The meaning of any living organism is to be found by enquiry into the reaction of the organism to certain forces in maintaining its existence. In man there has been a unique, complicated specialisation of function in the interaction with his ambient and consequently a unique bodily structure has arisen. This is characterised in his upright carriage.

The bipedal bearing of man must have met with many fortunate conditions to permit and uphold the ever-increasing difference between his progeny and that of any other hominoid, instead of initiating a hereditary line of apes with an anomolous bodily form which shortly would make them unviable. Every further development that was induced by the extraordinary posture apparently was at least tolerable by the organism, and, in fact, tended to promote the most important result of the adaptive change in the skull, which was only just launched in the australopithecene man-apes: the specialisation of the brain. 17

The way in which environmental forces played on the structure of man with his 'extraordinary posture' has had many influences. One of

the most important being 'the gradual reorganisation of its (the brain's) many substructures, and some consequent changes in the relative rates of advance and elaboration of their respective functions'.<sup>18</sup>

In man, where the operculum is particularly favoured by anatomical conditions, its cortex seems to have taken the lead in the evolution of his entire central nervous system. The latest-developed mechanisms in a living being are, as Titchener observed, the most active, and in the nervous tissue where electrical and chemical processes are normally of highest intensity they are most ready to attain psychical levels. This leads to a great refinement and quickening of every sort of feeling, peripheral and central, i.e. receptive, somatic, emotive, or of nameless other kinds. 19

Other specialisations have occurred namely the use of the hands as sensory organs, and the increased use of peripheral receptors due to the development of the fore-brain.

Man's increased motility is a function which entrains as acts an increased amount of neuro-muscular and brain activity. (In lower animals nervous functions move simply through the lower centres of the spinal cord and result in direct muscular response.) Man's motility or movement potential has as sub-acts a host of muscular-neurological-brain acts which, through their interaction of inhibition and induction, create a complexity which has defied conceptual analysis. However there are certain functions of man's movement which may be empirically observed. The most elemental is the function of movement in man's dialogue with the force of gravity. The force of gravity is a continuous threat to the upright structure of the body. Through a trial and error process and obviously aided by his structure and genetic heredity, the human baby comes to command balance. This act is contained in the hereditary basic

---

18. S.K. Langer, Mind: An Essay on Human Feeling, Vol. II pp.254-255.

19. S.K. Langer, Mind: An Essay on Human Feeling, Vol. II p.255.



behaviour of man, since all human beings stand up-right (except in the cases of bodily deformity, e.g. spinadifidae patients). However, this is not to say that balance is solely an autonomic or habitual act. Dancers, ice skaters and mountaineers are able to adjust their 'sense of balance' to their respective occupations. For example, the performing of very fast pirouettes creates sufficient centrifugal force to influence the balancing receptors in the inner ear. The dancer learns to ignore these sensations of giddiness and maintains balance through visual orientation. When balance is threatened, the increase excitation of neuro-muscular activity results in feeling and often in emotion (as explained above, emotion is taken as a necessary sequent to mind and vice versa). However, if maintaining one's balance is described as a volitional act, which common experience tells us it is, then it must be assumed that mind influences the movement of the body. The causal link between mind and bodily movement may be argued here to be possible because of a qualitative likeness of experience of both body and mind. Both mind and bodily movement is experienced as events and may be perceived as acts. It does not follow from this that parallelism is a logical consequence of this qualitative likeness. Parallelism argues that every mental event has a parallel event in the physical body. What is being argued here is that mind may be volitional in inducing behaviour or movement but is not the sole cause of that movement or behaviour.

It will be shown later that the art of dance is involved with the volitional induction of dance movement by the mind. The movement of the body in dance transcends the objective actuality of the body towards some imminent and virtual act. In this way the human body is intentional,

that is, the mind has a volitional influence on the dancer's movement. When one is concerned with human movement in general, then the volitional influence of the mind may not be taken as a prima facie of every movement phrase. It is precisely the difference between random spurts of intentionality and intentionality that continually transcends the body object, that allows dance to be considered as an art form.

The mind, which may either be a sequent to movement or volitional in inducing movement, internalises space and time as order. Events are related to other events through the experience of kinaesthetic images. The process of image-making in man has its source in kinaesthetic sensations (neuro-muscular activity), feelings and emotions. It has been pointed out that there is no straight line progression from sensation to image-making. It is possible for sensations to initiate acts that are completed as other sensations of muscular activity but which have transitory image sequents. Sensations do not always result in bodily activity but sometimes the act sensation completes itself in the mind as thought. Acts of the mind may remain as imagined acts, and yet be accompanied by small fragmented gestures. Finally volitional acts of the mind may be projected as complete movement acts which have space and time internalised as an image of order because of the nature of their appearance.

PART TWO

---

THE ACT CONCEPT IN RELATION TO THE CREATIVITY OF THE CHOREOGRAPHER

## CHAPTER FIVE

### A DESCRIPTION OF CREATIVITY IN TERMS OF MOVEMENT.

Aesthetics may be described as the study in which meaning and value are given to art forms. It involves the knowledge we gain by perceiving art forms and by recognising our relationship to the art form. It is therefore necessary to attempt to describe the process of creating an art form before turning one's attention to discussions of the value of the art. This discussion will not be undertaken in the mode of the aesthetician, neither is its function that of assessing in terms of the art critic.

The artist must act in order to create. A description of this dynamic process (description being a transposition from one media to another) does not parallel the process of creativity. It can attempt to formulate in language that which is done by the whole being, usually without formulae.

Creativity is not something possessed. It is an act. Thus it is impossible to talk of creativity in general. Unlike the sciences which are able to move from the particular to the general, a study of creativity must if it is to make sense, remain closely linked to particular creative acts. Professor Morris Weitz's hypothetical definition of a work of art, illuminates the need for a study of the dynamic process of creativity to remain at the particular level and not to transcend into the realm of scientific formulae. He says in Philosophy of the Arts that 'Every work of art is an organic complex, presented in a sensuous medium, which complex is composed of elements, their expressive characteristics, and the relations obtaining between them.'<sup>1</sup> The only generality that may be

---

1. As quoted by A Boyce Gibson, Muse and Thinker, p.26.

found in this view is that in art there is a convergence of elements which in themselves remain distinct. The way in which the artist creates these elements so that they converge organically and yet maintain their individual expressiveness may only be demonstrated in the particular. The art of the choreographer will be investigated with reference to particular acts.

Earlier chapters have dealt with the concept of acts as a biological principle of adjustment, growth and change. The choreographer's art cannot be divorced from this principle. Initially, it was stated that the artist is concerned with the process of objectifying 'feeling' in external form. It has also been explained that projection of feeling involves the body and the mind, either as necessary sequents or as volitional elements, in this process.

Margaret H'Doubler has stated this same idea in relation to dance as follows :

The creative process is a co-operative activity: of the intellect, in constructing form; of the emotions, the motivation force for expression; of the body, whose active joints (the skeletal instrument) and muscles (the movement medium) furnishes the material for the organised external form; and finally of that intangible aspect of human personality, the spirit which animates these activities with greater significance. A created dance is born of the personality. In creating external form, the personality is expanded in achieving a form of expression and communication. Thus the personality is active in its entirety. 2

Although the whole personality is involved in the artistic projection, it is not 'the personality', nor the mind, nor the feeling, nor the body and certainly not the elusive element called 'the spirit' that is projected. The whole of man's humanness is involved in the act of creation and art is

---

2. M.N. H'Doubler, Dance: A Creative Art Experience, p.xxiii.

not a direct projection of that humanness itself. Thus the problem arises as to whether the choreographer's art belongs to the world of biological principles or constitutes its own world. History tells us that the primitive man's dance was mainly utilitarian. Its function was to express the material purposes of hunting through mimetic dance and the social purposes in imitative and convulsive dance. However, both material and social dance were strongly linked to religion and magic. The way in which the dance was performed was probably governed by ritual which favours repetitive rhythms and stereotype group relationships (the circle and the line) rather than representational free rhythms heard in nature and the representational arrangement of the group according to social hierarchy. The element of ritual, although not created consciously in any aesthetic sense was the element which, through socialising influences, came to be refined and which removed the dance from the immediate utilities of life. In Athenian Greece, dance became elevated to the realm of art and was consciously practiced for its beauty of form. H'Doubler writes:

The value of dance to individual development, although manifesting itself throughout the lower stages of civilisation was not fully realised until the Athenian civilisation. With these Greeks, dance again played an important role and became a deliberate feature of a philosophic scheme of education. 3

The shift from the primitive to the civilised Athenian seems to be a shift from dance as being part of the world to dance belonging to its own world. The proper place for the art of dance is still very much questioned today. The professional performer and the

---

3. M.H'Doubler, Dance: A Creative Art Experience, p.8.

educationalist both claim it for their own. It is possible that the art of dance has a rightful function in both areas but the way in which the claim is sought may be questioned. The educationalists tend to treat dance with a large dose of moralism, stressing the material content of dance as a means towards a general edification. The professional, on the other hand, regards dance as neither a reflection of sense-pattern nor as a vehicle for morals but as a thing which is entirely its own. At its worst this view is stretched to the point where the material content of dance is used as a means to amusement. The resolution of this dualistic claim on the art of dance may be resolved by following the concept of imagination in the writings of Kant, Hegel and Croce.

Kant saw that imagination had a part to play in the act of knowing itself. It is the preliminary synthesis, 'blind but indispensable' which assembles the data of sense prior to their final synthesis as scientific objects under the categories of the understanding. 4

This view is entirely in accord with that of the act concept. Imagination is to do with feeling and is itself a process whereby feelings are brought into some kind of relationship, without being dominated by the formalising function of mind. Furthermore, Kant following Moses Mendelssohn<sup>5</sup> separates feeling from desire and thereby establishes aesthetic feeling as being interested in form towards which desire remains indifferent. Kant does not confine 'form' to 'artistic form', yet it is a concept which is abstracted from the particular, be it natural or artistic, that bridges the gap between art being part of the world and art constituting its own world. It does this by bringing the objective of 'what is art?' to the organisation of sense impressions. It is a dialectic between feeling

---

4. Quoted by S. Boyce Gibson, Muse and Thinker, p.40.

5. See S. Boyce Gibson, Muse and Thinker, p.35.

and mind. This is essentially an aesthetic appreciation of art and says little of the artist's act of projection.

Hegel's concern is not with form in general but with the beauty of art. He distinguishes art from nature by the fact that art has to be produced, not apprehended.

'The beauty of art is the beauty that is born again, that is - of the mind; and by as much as mind and its products are higher than nature and its appearances, by so much is the beauty of art higher than the beauty of nature.'<sup>6</sup> Mind is so to speak, diffused in nature and concentrated in the human spirit. 'Mind, and mind only is capable of truth ... so that whatever is beautiful can only be really and truly beautiful as partaking in this higher element and is created thereby'.<sup>6</sup> Furthermore, Hegel demands that the artist must not see aesthetic form as divorced from the particular but that the artist should mould the material in accordance with the 'absolute idea'.

'Art is the absolute idea, expressed peremptorily in the construction of sensuous forms. It is of essence that the idea and the sensuous forms should be integrally fused.'<sup>7</sup> Unfortunately the universality of the 'absolute idea' is not demonstrated in contemporary dance, let alone in the other arts. Prof. Weitz's idea of 'organic unity' is more acceptable but it is a general principle which only has meaning

---

6. Translated by B. Bosanquet, Philosophy of Fine Art Introduction, p.4.

7. A. Boyce Gibson, Muse and Thinker, p.40.



in the particular instance of it. Croce's contribution is in his approach to intuition. Intuitive awareness, he argues, is not sensation but a creation that produces images and in this sense it can be identified with art. Like Kant's imagination, Croce's intuition is an act, the difference being that intuition is productive and expressive. The intuitive expression is not art. It must be projected by means of technique (which in itself does not make art) and is expressed in terms of a symbol. The act of projection is an act of construction, the art product is symbolic. In the art of dance performance is symbolic of the dialectic between sensation and feeling, intuition and thought. S. Langer has written

The connection with the natural world is close, and easy to understand; for the essential function of art has the dual character of almost all life functions, which are usually dialectical. Art is the objectification of feeling; and in developing our intuition, teaching eye and ear to perceive expression form, it makes form expressive for us wherever we confront it, in actuality as well as in art. Natural forms become articulate and seem like projections of the 'inner form' of feeling as people influenced (whether consciously or not) by all the art that surrounds them develop something of the artist's vision. Art is the objectification of feeling, and the subjectification of nature. 8

In this way, the symbol - the work of art - transcends the artist's feeling as through its articulation it expresses 'the nature of feelings conceived.'<sup>9</sup> It becomes involved with the natural world without relinquishing its individuation.

The beginnings of creative projection arise in the dialectic nature of acts, which may be felt as coming from within the individual

---

8. S.K.Langer, Mind: An Essay on Human Thinking, Vol. I, p.87.

9. This idea is Mrs. Campbell-Fisher's expressed in Aesthetics and the Logic of Sense .

or from the external world. This dialectic is that of imagination and form. As the projection becomes an 'idea' or an actual material form, it is characterised by sense and reason. Jean Philippe in L'Image Mentale (evolution et dissolution) has distinguished three phases of mental development which have as their counterpart three types of imagination. They are :

'(1) Initial ('imagination ébauchée), which is transient, protean, irrational-dreams, fleeting images, at a somewhat higher level fancies, vague hopes; (2) fixed ('imagination fixée) myth, speculative theories, art, and (3) objectified ('imagination objectivée'), or practical imagination, invention, truth.' <sup>10</sup>

He says:

Literally speaking, imagination is the activity which embodies in mentally perceptible forms the effects of our sensory impressions, present or past. Fashioned by this action,... the image is neither a memory nor an invention; it is a sheer representation, an image in the elementary and primitive sense of the word. <sup>11</sup>

It is with these images of sense impressions that the choreographer begins to work. They are fashioned according to their own laws of presentation. The dance is not usually pre-constructed as mental images but is performed into existence. The performance, which belongs to the natural world and which must be limited to the dancer's bodily structure, is a further source of stimulus to the choreographer as a manifest presence. For a dance to have an organic presence the visible movement becomes ordered in such a way that it is projected towards self

---

10. As quoted by S.K.Langer, in Mind: An Essay on Human Feeling, p.92.

11. As quoted by S.K.Langer, in Mind: An Essay on Human Feeling, p.93.

completion, both in its sub-acts of spatial form and in dynamic nuance. In great dance works these two aspects are inseparable, form and feeling are merged.

It has already been said that the initial impulse of any act is part of that act. The image, which is a mental embodiment of our sensory experiences is part of the act of artistic projection. It only becomes part of this act if it induces neuro-muscular activity and this is dependent on the strength of the initial impulse and the tone of the already ongoing acts. Therefore it becomes clear that the process of projection may not be described in terms of any one act-pathway. There is no formula for an act of creativity. The texture of the process is characterised by its dialectic nature. To quote George Beiswanger:

Dancers are thought of and put together in the course of a continuing dialogue between composing and considering; between the doing and the viewing mind, both at work within the dance-making process and on intimate, if not always easy, terms with each other. 12

It is possible to discern aspects of the dialogue which, in the alteration, work towards projection.

Philippe's three types of imagination do not each lead directly to creative action. Firstly 'imagination ébauchée' is clearly different from memorising or memory images. Memory images arise from past experiences, they are images of things seen or experiences felt. Imagination ébauchée is autonomous imaging. The images are not consciously directed nor is the order of their appearances to the mind regulated by the order which is experienced in movement. This 'day dreaming' is

---

12. George Beiswanger, Doing and Viewing Dances, A Perspective for the Practice of Criticism, Dance Perspective 55, p.8.

essentially private, but it is possible to account hypothetically for its connection to direct image-making. If 'day dreaming' is accompanied by a particular physiological process (this possibility has been established, see Chapter 3) and directed image-building is associated with a different physiological process, then we may state their relationship thus:

1. Day dreaming can go on in the absence of directed image-making;
2. Directed image-making depends on the elementary images which are present in day dreaming; and
3. When directed image-making is going on it modifies day dreaming by either an inhibitory or inductive influence.

When the third type of relationship occurs, active and deliberate thought exists (imagination fixe). The sub-acts of undirected image-making have been commented on by Freeman, Burcher and Christie (1968). As a result of their psychological testing they conclude that: 'It seems highly likely that differences in creativity (creative output) are more related to non-cognitive than to cognitive traits'<sup>13</sup> and Shouksmith suggests the place of both modes of image-making in the creative acts.

The evidence suggests that creative thinking involves an open approach in its early stages, but requires the ability to change to a restricted style at the appropriate point. First steps in the creative process appear to involve 'freedom from evaluation' (Wallach and Kogan 1965). But once the essential elements have been isolated and related, the truly creative act requires the creator to switch to a perseverative mode... . This perseveration seems most likely to be concerned with connections and not with elements ... . It would appear, that the two modes are not in opposition but represent two independent parts of the overall process. 14

---

13. George Shouksmith, Intelligence, Creativity and Cognitive Style, p.133.

14. George Shouksmith, Intelligence, Creativity and Cognitive Style, pp.203-;

Although the above point of view seems highly likely, it is also possible that the order is reversed, or that the two forms are so interwoven with each other that introspection is incapable of differentiating between directed and undirected image-making. A dance does not come into being unless somebody dances. If the choreographer is also the dancer then he operates with 'imagination objective'. It is at this phase that dance becomes a presence which may be described as symbolic. It possesses form and content which, in the sheer presence of the dance, is objectively discernible. The import of art, which seems to be caught in the symbol, is not reducible to a set of general rules, as is necessary in breaking down discursive and factual statements to syntactical construction. Any symbolic form has a multiplicity of functions and, in this way, is a true projection of feeling. The elements in organic functions have no exclusive, separate and singular existence save for the situation in which they are involved. The same is true of the elements which arise in a symbolic projection of feeling. Langer says of the perception of our inner life that

The constellations of such events are largely non-linear, for where sequences occur they normally occur simultaneously with others, and every tension between two poles affects (evokes, modifies, cancels or precludes ab initio) many concomitant ones having other poles. The tensions of living constitute an organic pattern, and those which arise to a psychical phase - that is to say, felt tensions - can be coherently apprehended only insofar as their whole non-psychical organic background is implied by their appearance. That is why every work of art has to seem 'organic' and 'living' to be expressive of feeling. 15

The creation of a work of art is sustained by the imagination because an image, at whatever phase, has the function in life of giving to

---

15. S.K. Langer, Mind: An Essay on Human Feelings, Vol. I, p.103.

our minds the appearance of something objective. Yet the image maintains a felt link with our so-called inner subjectivity. The rising and fading of images, without directed or concomitant links with the total fabric of our 'imaged feelings', has already been described. In order that an artistic projection occurs, it is necessary that the images are held together by the artist's idea. This idea is generally one of quality.

Quality is not synonymous with style. Style may be recognised in dance as belonging to a particular tradition, for example the 'classical style', which today is becoming more and more difficult to contain within boundaries, or the Graham style, jazz style, or the styles of different national dances. The 'idea' of quality on the other hand, is described as follows :

The sole artistic intent is to present his (the artist's<sup>+</sup>) idea of some mode of feeling in the nameless but sensible quality which shall pervade his nascent creation. There may be many reasons why he wants to realise and present this particular import; it may preoccupy him, torture him, so he has to objectify and face it; it may merely intrigue him, because he has but partly known it, and thinks his own work would complete the revelation; or - very often, perhaps normally in working on commission or by command - the material and the stipulations themselves suggest a form congenial to the artist's 'habits of emotion', which is the tenor of his artistic imagination. 16

Quality in life is a mode of feeling intuitively grasped by the mind through the spontaneous presence of images which also feed, focus and reshape emotions. This is a continual dialectical process. In dance the idea of quality is projected through the inter-relationships that are set up between elements of spatial and effort articulations created by the dancer. The import of dance may be described as the illusion of

---

16. S.K. Langer, Mind: An Essay on Human Feelings, Vol. I, p.124.

+ my insertion

interacting forces. It is an illusion in the sense that they are not seen in the same way as a dancer's body is seen and yet they command our attention beyond that of the dancer's body. E.J. Furlong has disagreed with this point of view. He says:

Certainly in watching ballet we may abstract, to some extent, from the human shapes, and allow our attention to be taken by the moving pattern of white colour. But I find it hard to agree that we do not see people moving around: their faces and limbs are still of some interest to us, and even if we close our eyes to these, we should still be conscious that the makers of the pattern are human beings. 17

Any performance in the theatre, be it opera, drama or dance, always operates on more than one plane. Firstly, there is the physical presence of the actors or dancers and secondly, there is the illusion of character or force which they present. In combining these two matrices by means of their simultaneous presentation, the audience 'biassociates'<sup>18</sup> the real with the unreal and vice versa. This biassociation of performer and performance is historic. Don McDonagh gives an example of how Ruth St. Denis was able to give the illusion of a 'special sinuousness flowing across the chest and into the arms'.<sup>19</sup> This illusion of extreme suppleness in performance was so great that doctors in Germany examined her arms in order to discover an unusual anatomical structure. None was found.

The choreographer's subject matter is that of the idea of quality. In order that this should have an organic nature it must be so constructed that the interrelations between the elements are concomitant with each other, in the same way as performer and performance are related. Furthermore, the elements in their progression should internalise space

---

17. E.J. Furlong, Imagination, p.92.

18. The Concept of Biassociation is developed by Arthur Koestler in The Act of Creation, see p.35.

19. Don McDonagh. The Rise and Fall and Rise of Modern Dance p. 27

and time as acts rather than concentrating on fixed or held positions and moments. The import of dance is quality. This is a projection of the idea of feeling which in turn is intuitively brought to mind through a progressive formalisation of images. The choreographer objectifies these intuited images through the movements of dancers and the dancer defines the mode of expression. In the traditional classical ballet the traditions of style gave a distinctive idea of quality that was clearly rooted in the conception of harmony as geometrical ratios expressed in the Golden Section. O.F. Regner (1954), in stipulating the aesthetic requirements for ballet, says they are 'measured harmonious beauty of movement; harmony between the dancer-ego and the world; sense for the specific gravity of the body - that is, preservation of its structure and regard for the function of the movement'.<sup>20</sup> (Otto Friedrich Regner, *Das Balletbuch*, Frankfurt, 1954, p.156)

These requirements are limited to the perception of form with no mention of the need to reflect the 'inner life'. It is an attempt at empirical objectivity and it does not regard the fact that even general bodily movement is sheer projection of images, even though they be in 'Philippe's' initial stage of imagination. Furthermore, the classical ballet is characterised by two tendencies of bodily movement, firstly, the arabesque, which may be extended into the 'grand jete' and appreciated in terms of form as the continuous line and secondly, the 'attitude' used in the 'pirouette' and first and fifth positions of the 'port de bras'. This may be appreciated as the closed form. Even the dancer's relation to the audience is spatially formalised in 'en face', 'ecarte' and 'efface'.

---

20. As quoted by Wilfried A Hofmann, Of Beauty and the Dance: Towards an Aesthetics of Ballet - Dance Perspectives 55, p.19.



But probably the greatest idea of quality inherent in the Classical Ballet is the indisputable vertical axis of the upright body. Asymmetry is only tolerated insofar as it does not question this permanent point of reference. This factor of 'objectified form' being the basis of aesthetic judgment has led to a considerable confusion between 'taste' and 'aesthetics'. Wilfried Hofmann, in his Of Beauty and the Dance, has said: 'The single "en dehors" movement seems to me to be essentially more aesthetic than the "en dedans"'.<sup>21</sup> This he substantiates by saying '... The centrifugal corresponds to the optimistic, active, developing healthy person. This positive is not just a legacy of the 'exalted, proud, pure Hellas' (Volynsky) it corresponds to our essence'.<sup>22</sup>

Besides the fact that his elements of correspondence are strained, offering a one to one relationship, there is also the confusion between his personal taste and his aesthetic judgment. Secondly, the inability to see dance as movement provides ground for a counter argument to this point of view.

The emphasis on 'a turned out posture'<sup>23</sup> in the classical ballet is a matter of increasing the skill of the muscular-skeletal structure. For example, in order to raise the leg above 90° 'a la seconde' from the vertical axis, it is necessary to 'turn out' in the hip joint. However, Hofmann speaks of the centrifugal as being a permanent body attitude that allows for little change. In this way it has become a limited discipline, dictated to by taste and in danger of ignoring the essential dynamic nature of dance which is change of quality.

---

21. Wilfried Hofmann, Of Beauty and the Dance: Towards an Aesthetics of Ballet - Dance Perspectives 55, p.24.

22. Ibid.

23. Ibid.

Quality and form are not two disparate opposites. In considering the imagination it is necessary for the purposes of discussion to differentiate between pictorial, symbolic and kinaesthetic images. There is strong evidence in neuropsychology to suggest that these three kinds of image-making are not as distinct as they are often thought to be. For example, in dance kinaesthetics, images are the background from which spatial and temporal imagery emerge. The virtual presence of 'effort' (the kinaesthetic image) is the primary illusion of all dance styles. The illusions of space, time, weight and flow are secondary illusions which emerge and fade back into the plenum of 'effort'. The waxing and waning, the emergence of form and the disappearance into this plenum of illusionary 'effort' or vital force gives dance its organic nature. Each emergence of a secondary illusion is an act which bears a relationship with all the other acts and which has significance only within the context of the work as a whole. Often these acts do not reach their completion before they disappear back into the primary illusion. These incompleated acts, when repeated, identically or in a developed or transposed form, give 'life' to the dance. Their appearances from the main body (the primary illusion) creates a semblance of the projection of inner life of the work itself. Because of their transient nature, which exists in completing and dissolving forms, their import is one of sheer vitality which reflects the idea of organic feeling. The choreographer, then, creates through projecting a symbolic kinaesthetic form, which appears as a primary illusion of 'effort' or of 'force'. 'Effort' itself seems to project secondary illusions of space, time, weight and flow which reflect the inner vitality of the dance work.

The system of notation created by Laban supplies a means by which these secondary illusions may be more fully investigated. It is basically designed for recording and analysing movement. The fundamental criterion that of the primary illusion, is not presented in the notation, nor can it be; the primary illusion is only created in the act of dancing. The concerns of the choreographer, in terms of these secondary illusions will be discussed in the following Chapter.

CHAPTER SIX

## ACTS AND SUB-ACTS IN DANCE

The secondary illusions of internalised weight, space, time and flow are caught up in the progression of movement. There are certain natural tendencies and limitations which arise as a result of the body structure and create a natural potential for particular directional movements to entrain specific qualities and not others. This is not to say that it is impossible for a dancer to entrain unnatural or unlikely qualities in a particular directional movement. Indeed the classical dancer aims in his training to give the illusion of lightness in actions which often require an incredible exertion of muscular power.

For the audience the illusions of space, time, weight and flow are one matrix or field of reference; the other is the movement of the body. In dance these two matrices are presented simultaneously and creates an illusion in which the audience is suspended between the physical reality of the dancer's body and the emotive inducing import of dance which is feeling. In pure lyrical dance, where there is no characterisation, plot or narrative line, the images which occur when these two matrices are biassociated, are the images of weightiness and bouyancy, quickness and continuousness, directedness and plasticity, sticky progression and fluidity of progression. These are archetypal images of quality which lead from the particular felt experience to the universal frame, for example, quickness may lead to an illusion of time and directness to an illusion of space.

These archetypal images achieve overtones of universality in that they appear as particulars which emerge from the background of universal

space, time, weight and flow and which after qualitative definition, subside into this background. They are also evocative in the sense that, on reaching a qualitative definition, the interplay of definitive acts, their relationship, the entraining, the inhibiting or inducing influences, bring other matrices together so that each matrix is individually transformed. (Each matrix may be seen through the perspective of any one of the others.) By narrowing the field of vision the elements of quality remain distinct, but when the dialectical nature of qualitative acts is observed, that is, when the art impresses one in its total import, then the elements are transformed into an organic complex.

This organic complex, with its sub-acts and sub-elements, does not happen without design. It is created by the choreographer. His initial impulse or insight may not be a vision of the total 'idea' to be projected. It may only be imagination ebauchée in which the two matrices of the physical and the virtual have momentarily been biassociated. Lincoln Kirstein in his discussion on Balanchine has described this initial impulse and how it is developed.

In a Balanchine symphonic work, he will take a certain grain or quality of movement, rather like a chord based on the original theme of an orchestral piece, and exploit this grain to its utmost. The grain, for example, in his 'Mozartiana' had a curious feeling of out-thrust, expectant, bold and capricious high stepping wilfulness. The grain chord or quality was never lost, however much it may have been developed on the original statement. He chooses his scale and makes his pattern change on a consistent texture. 1

The initial impulse arises, as has been explained in Part One, as a result of the dialectic between sense impressions felt as impact and

---

1. L. Kirstein, Blast at Ballet, Three Pamphlets collected, p.24.

sense impressions felt as impulse. Because man's impressions rise to an imaged phase even though it may be fleeting and momentary, they allow him to use these impressions within the created complex. If sensation images are to become an idea, it is necessary that they are perceived by the mind and organised into some sort of an association. If they are not, it is likely that they will not become symbolically projected into the art work, save as vague, indistinct overtones. It is for this reason that the impulse must become an idea at an early stage in the act of creation.

Whether the choreographer actively works for this idea or whether it arises as a result of a natural dialogue within himself or between himself and his ambient, is dependent on the individual. A. Koestler, in his survey of scientific creativity, suggests that the idea, more often than not, appears to the scientist as a vision, a sudden idea, insight or inspiration. The problem is faced but the solution is not evident as an idea nor is it methodologically worked out. It arises as a result of two matrices becoming biassociated. This biassociation, again, arises as a result of further chance impressions or suddenly it becomes clear on waking up from a dream or even whilst day-dreaming (imagination ebauchee).

Unlike the scientist, the choreographer has to present to himself and to his dancers an organisation of fluid movement that results in a distinct qualitative kinaesthetic response in the dancer. The secondary illusions require articulation as movement; in other words the idea must include kinaesthetic imagery which is both communicable and of a distinct texture of qualities. Traditionally the classical ballet has formulated a number of 'pas' (combination of steps or movements of the feet) and

'port de bras' (carriage of the arms). These in turn centre around the vertical axis and the principles of the 'attitude' and the 'arabesque' (a contraction and an extension). The classical vocabulary was, in the Romantic period, based on an illusion of 'other worldliness' in both subject matter and technique, and has since developed a strong concept of muscular and skeletal possibilities. The phasing of these physical acts to psychical and mental acts has brought forth an understanding of technique as a concept which embodies more than just the movement of the body. Margaret H'Doubler has given a description of the kinaesthetic sense as the mediator between technique and consciousness of feeling and control.

The receptors may be thought of as analyzers of our environment, splitting it up into its component parts, each particular receptor attuned to certain aspects of the external environment and the milieu interieur. Besides the usually mentioned five senses, there are organs of other senses responsive only to the conditions within the body itself. The group of sense organs that are of special interest in the study of movement are those in the muscles, joints and tendons. They are stimulated by the activity of these parts, reporting to the mind the exact state of muscular contraction, the range of joint movement, and the tensions of the tendons in any movement. It is by means of this movement sense - the kinaesthetic sense - that we can judge the timing, force and extent of our movements; and adjust ourselves consciously or automatically to this information. To this group of receptors also belong the organs of static and equilibratory sensations, which serve to maintain body balance and posture. 2

The kinaesthetic sense is the field from which the secondary illusions emerge. The communicability of the 'kinaesthetic sense' is for the most part left to the individual choreographer's powers of visual and audible skill because the experience is for the most part









---

2. M. H'Doubler, Dance : A Creative Art Experience, p.

pre-reflective. Many theorists have attempted to formulate an analysis of kinaesthetics. The classical ballet has only a very few terms to describe quality or feeling. At its best this communication takes the form of verbal imagery or quasi poetry. However the demands made upon the dancer in terms of 'tempi' and 'pas' to be performed, often bring out a natural relationship between the form of the 'pas' and the quality of effort necessary to perform the 'pas'.

The roots of the classical ballet are to be found in classical Greek Tragedy and particularly in the function of the chorus. The function of the Greek chorus was to form a bridge between the actors and the audience. This was not only achieved through the physical nearness of the chorus to the audience (they performed in the orchestra, whilst the actors performed on the skene), but also through their mode of performance. They reacted to or interpreted the action of the main actors so that the audience was led towards a common emotional and intellectual perspective of the playwright's intention. Furthermore they created the mood of each scene through the integration of speech and movement, which was structured according to strict rules of poesis. The meter of the verse had obvious emotional connotations. The mood and feeling of the different metrical rhythms have been suggested by Laban as being :

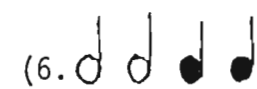

	(1. 	The Trochee is a graceful, placid calm rhythm
	(	
Three	(	
Time	(1. 	The Iambus is more aggressive and was, in spite of being used in the female Lydian mode, often taken as the male contrast to the Trochee. It is gay and energising without being rude or belligerent.
Units	(	
	(	
	(	
	(	
	(3. 	The Dactylus is grave and serious, being used in processions on solemn occasions.
	(	
Four	(	
Time	( 	
Units	(4. 	The Anapestus is a march rhythm indicating advance; occurs in dances of moderate temper.
	(	
	(	
	(5. 	The Peon is the expression of excitement and foolishness, and evokes alternately terrifying and pitiable states of mind. It appears in war dances.
Five	(	
Time	(	
Units	(	
	(6. 	The Ionian expresses violent agitation or its contrast, profound depression. The drunkenness of Dionysian festivals, langour and despair were thus expressed.
Six	(	
Time	(	
Units	( 	
	(	

In this way, the connotative import of both the spoken and danced chorus were formulated. Besides the metrical construction of the verse, there were also specific types of dances. They have been described as :

---

3. Laban, Mastery of Movement, p.130.

Emmeleia : this was a grave, serious type of dance, typically used for tragic themes; it embodies a code of symbolic gestures through which the dancer could tell the entire story of a dramatic work without speaking.

Kordax : this was the characteristic dance of comedy, and has been described as obscene and ignoble; it involved suggestive rotations of the body, kicking one's buttocks, slapping one's chest and thighs and similar movements.

Skinnis : this was the dance typical of the Greek satyr plays during the sixth century B.C. It was lively, vigorous and disrespectful, with much horseplay and acrobatic movement; often it involved satirical re-enactment of mythological themes." 4

The kinaesthetic response to the movement in Classical Greek dance was formulated within a strict regard for form. Its essence was that of 'tempi' or rhythmical stress coupled to the tonal pattern of the speech. The heritage for the modern choreographer from Greek drama is that of the form of the dance, with the principal dancers supplying the plot of the drama and the 'corps de ballet' directing the attention where and when it is most needed. It is also possible that the traditional idea that music is the means by which the audience becomes aware of the emotional import of the dance is derived directly from the close link between the spoken verse and the movement of the Greek chorus.

With the revival of learning in France under Francis I there was an attempt to reformulate the link between the arts and feeling. Music was considered to be the most powerful influence in moulding the kinaesthetic response.

It is the opinion of many great personages, both ancient legislators and philosophers that it is of great importance for the morals of the citizens of a town, that the music current and used in the country should be retained under certain laws, for the minds of most men are formed and their behaviour influenced by its character, so that when music is disordered, their morals are also depraved, and where it is well ordered there men are well disciplined morally. (Preamble dated 1570) 5

---

4. Richard Krause, History of the Dance, p.39.

5. Joan Lawson, A History of Ballet and its Makers, p.13.

Jean-Antoine de Baif, a member of the Pleiade invented a system of 'vers mesures' in which he attempted to unite music with dance. In its essence, De Baif's theory was to allow the metrical rhythm of the words to dictate the musical rhythm. The dance was to be in accordance with the timing and the phrasing of the notes. The direct import of the dance was little realised, and in order to achieve the desired effect on the audience the dance became heavily symbolic in a pantomimic way. It was through the use of allegory and symbolism, which was more often evidenced in the costume and the general design than in the dance itself, that the choreographer achieved his effect. Indeed the meaning of the performance became so involved that

In their desire to ensure that the audience fully understood the implications of the tale of Circe, the authors appended four explanations of the fable to their libretto, the first pointing to the physical allegory; the second to the moral allegory; the third relating the story to Time and the Four Seasons; and the last ... was an enlargement of the moral and the physical allegories. All these explanations are highly complex and are derived from a famous sixteenth-century book on mythology by Natali Conti. It becomes clear when reading the text of the words spoken during the action and the meaning hidden in the four explanations, that only those fully acquainted with subjects discussed by philosophers and academicians could appreciate the full significance of the spectacle as a short analysis of some of the difficulties facing a member of the audience. <sup>6</sup>

The first dance that did not rely on heavy symbolism and on words in order to communicate its intent was a mimed scene in an episode from Corneille's *Horace*, performed at the sixteen fetes given by the Duchesse Maine at Sceaux. This was performed by two dancers, M. Balon and Mlle Prevost who incidentally, were later criticised in London as being incapable of expressing anything in Nature.

---

6. Joan Lawson, *A History of Ballet and its Makers*, p.16.

In 1706 Feuillet wrote a work in which he attempted to create a system of notation in order to analyse the steps of the dance. John Weaver (whose works appeared between 1706 and 1728) basing his theory on Feuillet, stated the basic principles of the dance as Sinking, Rising, Turning and Springing. These actions provided the light and shade in the dance. The focus on the kinaesthetic potential of dance has its beginnings in the refocusing of attention from the music to the movement of the dance itself.

With Angiolini (1723 - 1796) and Jean-Georges Noverre (1727 - 1810) the ballet moved more and more rapidly away from the superficial idea suggested by the Encyclopedists, Diderot and Rousseau, that it would be fun to play at being shepherds and shepherdesses, pastoral gods, goddesses, nymphs and satyrs, and focused on the expressiveness of the dancer's movement.

In the nineteenth century the classical technique was developed primarily through the work of Carlo Blasis who, besides his concentration on the pure technique of movement, in which he mastered the means by which a dancer could balance 'sur les pointes' and perform many 'pirouettes', was aware of the quality of movement. This he thought was to be found in the qualities of the dancer himself. He describes these qualities as being:

1. Steadiness and equilibrium.
2. Natural ease and facility.
3. Keen observation and an analytical mind.  
Worship of beauty and no deviation from classical principles.
4. A knowledge of how to discriminate between the various types of dancer and a knowledge of one's own limitations.
5. An interest in dance composition in order always to make it seem that the performance was a spontaneous interpretation.
6. A study of drawing and music. <sup>7</sup>

---

7. Joan Lawson, A History of Ballet and its Makers, pp.58-59.

Although these qualities are helpful to the dancer, they do not in any way describe the qualities of the dance itself. The transition from lived experiences or educational principles to actual performance was expected to take place as though in a natural series of events. Other attempts to formulate the qualities necessary to dance were done by August Bournonville. He presented these in a tabloid form; whether there is any correspondence between the physical, intellectual and artistic qualities is not clearly stated, but there does seem to be some indication that a physical quality could lead to an intellectual and artistic one.

<u>Physical Qualities</u>		<u>Intellectual Qualities</u>		<u>Artistic Qualities</u>	
Beaute	<i>Beauty</i>	Goute	<i>Taste</i>	Grace	<i>Grace</i>
Vigueur	<i>Vigour</i>	Energie	<i>Energy</i>	Legerete	<i>Lightness</i>
Souplesse	<i>Suppleness</i>	Perseverance	<i>Perseverance</i>	Aplomb	<i>Aplomb</i>
Vivacite	<i>Vivacity</i>	Imagination	<i>Imagination</i>	Moelleux	<i>Mellowness</i>
Oreille	<i>Ear</i>	Harmony	<i>Harmony</i>	Precision	<i>Precision</i>
<u>Dramatic Qualities</u>		<u>Technical Qualities</u>			
Stature	<i>Stature</i>	Place	<i>Position</i>		
Physionomie	<i>Physiognomy</i>	En dehors	<i>Outward</i>		
Marche	<i>Gait</i>	Pointes	<i>Point work</i>		
Porte	<i>Carriage</i>	Ballon	<i>Balance</i>		
Geste	<i>Gesture</i>	Brillant	<i>Brilliance.</i>		

Perhaps one of the greatest contributions that Bournonville gave to the dance was the clear distinction between the qualities of the female dancer and that of the male dancer. The male dancer was distinguished by a breadth of style in the 'porte de bras' and in grand elevation, the female by gracefulness, daintiness and exquisite lightness.

It was not until the twentieth century that the search for the link between style and feeling got under way. With the birth of the

---

8. Joan Lawson, A History of Ballet and its Makers, pp.59-60.

new concept in the study of man, namely psychology, the focus of attention moved from the outer form of the dance to the involvement of the dancer with the dance. Psychology not only redirected the attention of researchers but it also provided a new vocabulary with which to discuss the inner state of man.

One of the first twentieth century theorists to attempt to describe and formulate a theory of movement and its relation to quality was Francois Delsarte. His theory was based on a 'triune' division of the body.

This triune division consists of the physical, intellectual and emotional sources of action which have a correspondence in the body restricted by space, time and motion.<sup>9</sup> Besides the above relationship, Delsarte separated the body into three divisions which have rather dubious representations. The head represented the intellectual, the legs and arms the physical, the trunk the emotional natures. He furthermore, divided each of these into three smaller divisions. For example, the head consists of the trinity of - forehead and eyes representing the intellectual, the nose and cheeks the emotional, and the mouth and lips the physical natures. The divisions of the torso were - the upper chest (thorax) - intellectual, the middle section (the diaphragm) - emotional and the lower abdomen (pelvic area) - physical natures. Similar divisions were made for the arms and the legs. This body/meaning/feeling relationship seems to be based on Lavator, an author of a work on Physiognomy (1772 - 1783).

---

9. The similarities and differences between Delsarte's theory and that of Laban's will be discussed later in the Chapter.

These three states of Soul do not lodge in separate apartments of the body, but co-exist in every part, and form, by their combinations, one form: yet it is true that each of these principles has its particular place of residence in the body, where its preference manifests and exerts itself. 10

This concept, although it may be regarded in its attempt to present a unified wholeness, is completely fallacious. The fault lies in the inability to distinguish between 'words' and movement, thought and feeling, as stated in Chapter 1. 'Intellect', 'Emotion' and 'Physicality' are presented as things possessed and are directly equated with parts of the body.

Delsarte's laws of Motion suffer a similar lack of perspective between analysis and action. These laws have been summarised as follows and a comparison with Laban's analysis is also indicated

1. The law of Motion: the centre of his system. Motion is energy expending itself. Physical motion moves outward from a centred focus; intellectual motion moves inward toward this centre; emotional motion appears in either concentric or eccentric forms, or by a poise or balance between the other two. 11

This concept of motion may be directly related to Laban's concept of 'Flow' which he qualifies as either 'bound' or 'free'. Bound flow is most harmoniously performed in a gathering action (towards the central focus) and free flow in a scattering action (away from the focus).

2. The Law of Velocity: The velocity of any agent is in proportion to the mass moved, and the energy moving. That is: serious ideas require deliberate gestures, lighter ones need shorter or more rapid ones. 12

---

10. As quoted by L. Kirstein, Three Pamphlets Collected, p.87.

11. L. Kirstein, Ballet Alphabet, p.34.

12. L. Kirstein, Ballet Alphabet, p.34.

The relationship here, is to Laban's 'Motion Factor' of Time, which is qualitatively distinguished by 'sustained' or 'sudden' movement. Laban related the Motion Factor of Time to the intuitive nature of Man.

3. The Law of Direction and Extension (in Ballet, the arabesque and the Attitude): All gestures have direction; physical gestures are projected forward or lengthwise, intellectual gestures, above or below, emotional gestures spread out laterally. The 'extension' of gestures is in the intensity of its surrender to the dominant intellectual, physical or emotional source. 13

The Law of Direction may be related to Laban's Motion Factor of Space, which is articulated either as an indulgent movement i.e. a flexible or plastic one or a contending movement, i.e. a direct, linear type movement. Laban relates this to the constantly refocusing of attention or the constant focus of attention. Furthermore Laban describes the three planes that intersect the body at right angles to each other as:

- A. The Vertical Plane -- 'a Sequence of radial lines resulting in circles of admiration (implying adoration, awe, resignation, disappointment) 14
- B. The Horizontal Plane -- 'a Sequence of radial lines resulting in circles of benediction (implying blessing, welcome, humility, solitude) 15
- C. The Sagittal Plane -- 'a Sequence of radial lines resulting in circles of submission (implying domination, obedience, devotion, pride, command) 16

- 
13. L. Kirstein, Ballet Alphabet, p.34.
  14. R. Laban, Choreutics, p.133.
  15. R. Laban, Choreutics, p.134.
  16. R. Laban, Choreutics, p.135.



4. The Law of Reaction (Darwin's second Principle of Antithesis: Motions arise from a reaction to habitual ones which are of no definite use, but which assert themselves with an involuntary strength and have the significance of contrast.) 17 Every extreme of emotion tends to react to its opposite. Concentric states tend to explosion, explosion to prostration (i.e. cessation). To shift from physical activities to repose, from anger to tears, from tears to laughter, etc. 18

Lisa Ullman has written

in harmonious movement --- the impulse to move is often more influenced by what happened before than by what is to come, or, in other words, the movement-impulse springs rather from reaction than from a desire for action. 19

This concept of polar influences in feeling is over-simplified. The transitions of feeling, instead of following a simple principle of homeostasis (the above concept implies this) follow a principle of growth, development and complexity. Similarly the impulse to move is not simply a reaction to past events but is a result of the textual content of the already ongoing acts within the organism.

5. The Law of Form: The exterior shape, or restraining figure by which matter is rendered visible. In gesture, all movements describe shapes of forms in the air. Straight lines are said to be dominantly direct, hence physical; circular lines, emotional; while broken lines are considered the result of obstruction consciously conquered, and hence intellectual. 20

This has been discussed under the law of Direction. Laban has however, developed the concept of form under the title of Choreutics. This is a complex analysis of spatial sequences which are related to the structure of the body and analysed within the framework of a regular Icosahedron. 21

---

17. R. Laban, Choreutics, p.135.  
 18. L. Kirstein , p.34.  
 19. R. Laban, Choreutics, p.149.  
 20. L. Kirstein, Ballet Alphabet, p.35.

6. The Law of Personality: Idiosyncratic characteristics conditioned by hereditary, environment, and local culture. 22

Laban developed a system of effort notation which abstracts from the general profile of the individual's movement those qualities which seem to be dominant or which are the most frequently used. An action profile is constructed by observing the order of appearance of these qualities as well as their phrasing and their use within specific environmental situations. This aspect of Laban's work has been developed considerably by Warren Lamb and Pamela Ramsden. In respect to the relationship between the Action Profile and Personality, Pamela Ramsden has written:

A theory is being proposed here that the behaviour described in what is called the 'action profile' is a cross between what is commonly known as personality characteristics and a particular aspect of what is known as motivation.

When it is considered that something about a person is individual and relatively constant it is usually said to be his personality, his character or his temperament or often in management, his style. When, on the other hand it is considered that something about a person is relatively transitory it is called mood or feeling or attitude. Therefore because the action profile is a constant and individual determiner of behaviour it is seen as coming under the heading of personality. 23

7. The Law of Opposition: When two limbs follow the same direction, they cannot be simultaneous without injury to the Law of Opposition... Therefore, direct movements should be successive and opposite movements should be simultaneous. This law is based on the physical human mechanics of equilibrium and gravity. 24

Although this law appears to be merely a concept of style rather than a fundamental truth of the body in action, it is supposed that it is based

---

22. L. Kirsten, Ballet Alphabet, p.35.

23. Pamela Ramsden, Top Team Planning, p.67.

24. L. Kirstein, Ballet Alphabet, p.38.

on the symmetrical nature of the body. If both arms were to be extended in the same direction at the same time, there may be a feeling of falling off balance. If this is what is meant by this law then it may be compared to Laban's concept of Harmony in which dominant movements, say on the right side of the body, are balanced by shadow movements on the left side of the body. That is, the performance of a 'five ring' on the left side of the body around the axis 'high-right' will be balanced by a shadow movement of the right arm around the axis 'deep left'.

8. The Law of Priority of Sequence: The suite in which agents of expression act. Impression always precedes expression; we must have before we can give, and give in the order of having. In general, Delsarte considered the physical nature asserts itself first, then the emotional, last the intellectual. But the will lends itself to which ever side of the being is in action. The eye reveals impressions first, the face responds, then follow the hands and other members. Articulate speech is last. 25

Movement does not, as has been already stated, only arise as a result of sensations felt as impact arising from the environment, movement may also arise as a direct projection of sensations which are felt as impulse. In which case, the movement may begin in any part of the body. Laban agrees with this, and has developed many exercises which help the performer to initiate the movement from different parts of the body.

9. The Law of Rhythm: The vibration or swing of matter through equal spaces in equal times. The pulsation corresponding to the heart beat under given emotional tensions. In gesture, the consecutive inflections of the bodies' members from joint to joint. 26

Laban's analysis of rhythm is not based on variations of the heart beat under different conditions of emotional response. His concept of rhythm is an organic one and is based on the emergence of qualitative repetitions or similarities from the general flow of movement.

---

25. L. Kirstein, Ballet Alphabet, p.38.

26. L. Kirstein Ballet Alphabet p. 29

Generally, Delsarte's laws are not substantiated by empirical research as the argument moves from the physical to the metaphysical without much logical development.

Delsarte's view of the inner man is that he consists of Mental, Moral and Vital expressions, and his artificial triunes, with their qualities and values, are just metaphysical speculation. The symbolic view of these expressions has value. The importance of the symbolic import for art has been defended by Genevieve Stebbins. She writes:

Delsarte was not a realist, he was an idealist of the highest type. The greatness of his system in dramatic culture consists in the fact that it rests on universal symbols of expression, instead of particulars. 27

It is the first time that a theorist has been able to transcend the limited requirements of a particular style which preoccupied the thinkers and teachers before him. He was able to see, however dimly and mystically, the possibility of abstracting essences from the general flow of movement, that were true in all situations and for all types of dancers and movers. One of the most important of these essences was that of 'contraction and release'. This was an awareness of 'effort' which Laban was later able to formulate and analyse so that it has become as much a part of the choreographer's language as are the sequences of movements through space.

Laban's analysis of effort allows for a discussion of quality of movement. Quality and hence the communicability of the kinaesthetic feel of movement from choreographer to dancer takes place at a more accurate level. The dancer in turn is able to project feeling not only as

---

27. G.Stebbins, Delsarte's System, p.43.

form but also as content without having to resort to pantomimic gestures of the type used in the 'opera-ballet'. Thus the subject matter of the dance has moved from the narrative style towards the direct presentation of feeling, abstracted from the realms of dramatic narration and plot, and developed according to the organic laws governing the growth, development and change of feeling and emotion itself. Before discussing Laban's analysis of movement in terms of its application to the secondary illusions in dance, it is necessary to review his basic terminology in the light of the act concept.

Much of Laban's work has been developed since his death, particularly in the field of education and industrial management. Rather than reviewing his early work on the relation of effort to the individual<sup>28</sup> which has already been assessed by authors such as V.B. Redfern,<sup>29</sup> it is more important to look at this field in terms of its latest development.

The relationship between movement qualities and 'motivation' (in the sense of action motivation) is based on the logical flow of any action. It has three stages, namely a preparation, which is some sort of action, a climax and a conclusion.

The Preparation : It has already been discussed in Part One as to how the original impulse in any act is already part of that act. It has also been shown that the initial impulse may arise as a result of an impactive (environmental) or impulsive (internal) stimuli, and as such no two stimuli are identical as they depend on the already ongoing tone of the individual. Thus a direct one-to-one relationship between cause and effect is impossible. Any stimulus that results in action, enters the interplay of acts in such a way as to modify the movement potential

---

28. See Laban and Lawrence, Effort, 1947.

29. See V. B. Redfern, Concepts in Modern Educational Dance.

of the individual. Laban distinguishes three types of essential elements that make up effort quality, namely focus, pressure and time. Unfortunately Laban does not clearly define these elements as movement. They are often used in such a way as to refer directly to the inner involvement of the individual with movement and as such they move from the phenomenological field into the metaphysical one. They will therefore be used here only in their reference to phases in the flow of action. What is observed as a preparation, may be one or a combination of any of the eight archetypal images of quality discussed on page 96 and which are derived from Laban's division of focus, pressure, time and flow. Pamela Ramsden has presented these images of qualities in the following tabloid :

THREE STAGE SEQUENCE OF ACTION	
Movement pattern: Effort Components	Shaping: Movement pattern Components
Action Profile : Assertion Components	Perspective: Action Profile Components
ATTENTION	
FOCUS	HORIZONTAL
indirecting -- directing investigating	spreading -- enclosing exploring
INTENTION	
PRESSURE	VERTICAL
decreasing -- increasing determining	rising -- descending confronting
COMMITMENT	
TIME	SAGGITAL
deceleration -- acceleration deciding	advancing -- retreating anticipating

She says the activation of these qualities in the body has a corresponding internal motivational state. This seems to suggest Parallelism. However, in a footnote<sup>31</sup> she defines inner motivation as

that which impels a person to act according to a certain pattern when there are no external motivating forces, i.e. when you are working for the sake of it, or 'doing your thing' for no ulterior purpose, internal motivation is what makes you take action in your particular individual way. 32

This definition is far from satisfactory. It reinforces the concept of 'inner' and 'outer' influences and by so doing suggests that there is motivation of the type that has nothing to do with the inner involvement of the individual.

Any stimulus whether impactive or impulsive enters the total tone of ongoing acts within the individual. The resultant action, if there is any, may be defined in terms of combinations of the eight archetypal images of the quality of movement. There is therefore no 'corresponding inner state'. The projection, that is the movement, is a result of 'acts' reaching phases of excitability sufficiently strong enough to result in bodily activity. Intentional and attentional movement as well as movement that is described by Ramsden as being committed, take place at the conceptual phase. The conceptual phase is different from the phase at which movement sensations become imaged. It is the difference between Imagination Ebauchee and Imagination Fixee. Intention, attention and commitment are therefore either sequents or results rather than causes. They arise when many sub-acts merge. Some of these acts will be biochemical and some of them will have reached the stage of 'feeling'.

---

31. See Pamela Ramsden, Top Team Planning, p.103.

32. Pamela Ramsden, Top Team Planning, p.103.

Imaged feeling (even at the phase of the kinaesthetic response) may be seen in minute gestures called 'shadow movements'. These may be small movements of the face, hands, feet or even small movements of the muscles in the thorax and in the back. Shadow movements do not reach the phase of ideation, and therefore are the direct projection of feeling without there being any formative influences from acts of ideation. These shadow movements demonstrate habitual act pathways and are only modified by continual inhibitive and entraining acts from both the environment as well as from conceptual acts. It has been suggested by Ullman that shadow movements are the reflection of the inner state of the individual.<sup>33</sup> Shadow movements are indicators of an inner state which projected movement (conscious movement) is unable to influence.

Shadow movements should be considered as sub-acts which may or may not be entrained or inhibited by larger movements. If they are entrained, then they add tone to the movement. If they are inhibited then they create a period of tension when the larger act is not totally projected towards its rhythmical completion but uses some of its initial impulsive energy to overcome the shadow movements.

The climax : It is here that the movement acquires qualitative definition which may be defined in terms of indirecting -- directing, decreasing -- increasing pressure, deceleration -- acceleration, and binding -- freeing of flow. The description, if it is to be at all realistic, will involve qualities from each of the four categories but with unequal stress or

---

33. See L. Ullman, Movement as an aid to the understanding and development of personality, in Movement, Dance and Drama, 1970, and M. North, Personality and Movement, 1971.



or quantity. Because of this unequal stress, some of the qualities will remain at the phase of shadow movements, that is they will not have reached the 'idea' phase, whilst those that have reached this stage will provide the dominant quality of the movement. Thus any projective movement will have sub-acts which are shadow movements that appear as overtones to the dominant movement motivation. It is also here that conceptual acts become realised as the movement becomes definitely formed. Mind becomes a positive sequent in the act of movement, and the realisation of attention, intention, commitment and relationship become evident to the mover as operant activities. At this phase the possibility of entraining or inhibiting other acts is at its strongest. This is a further factor in the clarification of quality. It is possible to draw an analogy here between optical inhibition of surrounding nerve endings on the retina of the eye during vision, with that of movement acts. The more defined the quality of movement is, the less interference there is of sub-acts of dissimilar qualities. The relationship between qualities in terms of similarity and difference may be illustrated as follows :

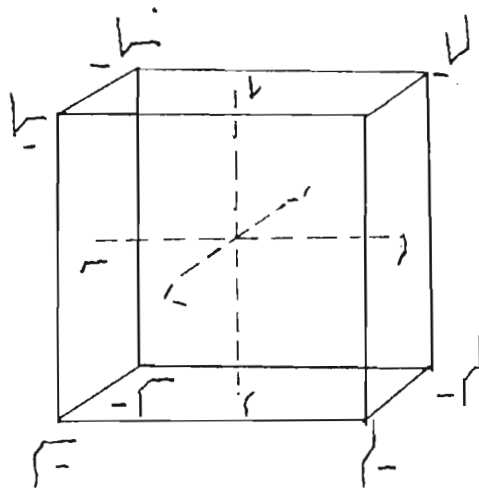

Effort actions which have their outer kinespheric forms in close proximity are related, while distance in their outer kinaesthetic form makes them lack relatedness. 34

Therefore  $\_ \curvearrowright$  ,  $\_ \curvearrowleft$  and  $\_ \curvearrowup$  have a relatedness to each other, both in terms of their expressive nuances (all have two contending attitudes and one indulging attitude) as well as in their trace forms. They are clustered around  $\_ \curvearrowright$  and are equidistant from each other.

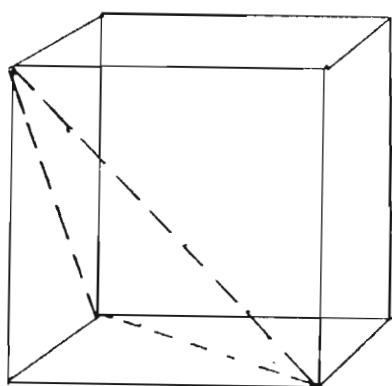

Fig. 9 Cube Showing those Effort Actions that are related to  $\_ \curvearrowright$

Similarly  $\_ \curvearrowleft$  ,  $\_ \curvearrowup$  and  $\_ \curvearrowdown$  are related. They all have two indulging attitudes and one fighting attitude.

---

34. R. Laban, Choreutics, p.

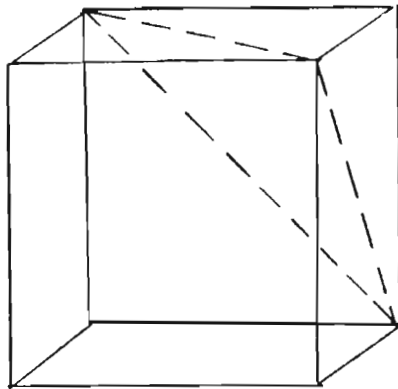

Fig. 10

The qualities of :  $\_ \downarrow$  and  $\_ \curvearrowright$   
 $\_ \curvearrowleft$  and  $\_ \downarrow$   
 $\_ \downarrow$  and  $\_ \curvearrowleft$   
 $\_ \downarrow$  and  $\_ \curvearrowright$  lack relatedness in both their  
 dynamic and kinespheric expression.<sup>35</sup>

The conclusion : Here the movement loses its definitive qualities and fades back into the general flow of movement. Its conclusion may be marked by an impactive quality followed by stillness, which is a part of the movement. The conclusion may also be lost in the emergence of a new act of movement which has arisen as a result of the inductive influence in the climax of the phrase. Because of the fading of definitive quality it becomes more difficult to discern the conclusion as particularly intention, attention, commitment or relation, it is likely that whatever quality displayed in the climax of the phrase will be fading in the conclusion.

---

35. F.R. Hagemann, Some Aspects of Eukinetics and Choreutics in Drama, p.59.

Thus besides the horizontal flow of qualities, there is also a vertical relationship between the super-acts and its sub-acts. In this way there is a complexity of texture that is usually most related in all its elements in the climax of the phrase.

The kinaesthetic sense is, then, the total response of the individual to the changes of quality in movement. In dance these qualities are selected and rehearsed so that at all stages of the movement phrase attention, intention, commitment and relationship are realised as a projection by the dancer. Furthermore, the phrasing of the movement in all its stages is an intentional projection. In this way it differs from everyday activity. The choreographer, in formulating and formalising them, creates a work that communicates the rhythmic pulse of feeling.

CHAPTER SEVENSYMBOLIC PROJECTION OF CREATED ACTS  
IN DANCE.

Symbolic projection requires that the subject matter of dance, which has been described as the idea of quality in feeling, reaches the level of conceptual thought. The material that the choreographer uses is the dancer's body together with his ability to experience kinaesthetics. There are initially three concerns in the process of choreographic creativity, namely the movement of each individual dancer, the relationship between dancer and dancer, and the communication of the dance to the audience. These concerns involve floor pattern, spatial design and dynamic patterns within the flow of the dance as a whole. In dealing with this aspect of the work the choreographer operates predominantly within the framework of imagination objective; it requires that he is both practical and inventive.

The possibilities of the dancer's body may be described within the imaginative framework of an Icosahedron.<sup>1</sup> This is a concept of scaffolded space. Its points of orientation are derived from both the body structure as well as from the two fundamental tendencies in movement namely those factors that induce change and those that inhibit change. These two concepts of induction and inhibition have been discussed in Part One and their application to movement in dance must now be developed.

The elements used in dance are abstracted from the symptomatic or referential context of everyday activities and synthesised according to the principle of organic growth. The final form is a symbolic presentation.

---

1. See R. Laban, Choreutics, pp.142-143.

In dance there is a continuous form-in-the-making, it is an uninterrupted flow of organised movement phrases; its totality constituting a single symbol. Each movement does not constitute a separate symbol and the total work is not a synthesis of many symbols. The analysis of dance into elements robs it of its symbolic import, yet this analysis is essential in order to discover the functions of the elements in maintaining and articulating the primary illusion.

The two tendencies of promoting or inhibiting change are elements which aid in the continuous unfolding of the form of the dance-in-the-making. The factors of orientation in space have an influence in induction and inhibition of change.

We found that the dimensionals always induce restriction; in the purely linear dimensions no natural movement is possible, in the dimensional-plane movement is possible but only restrictedly. In contrast to this is the pure diagonal, which is charged with movement intensity to such a degree that the movement flows on in an unrestricted manner. Therefore:

1. Dimension = restraining.  
Diagonal = promoting the flux of movement .....
2. Remaining in the same diagonal = restraining flux of movement.  
Transition from one diagonal to another -- Promoting.....
3. Plane-like shapes = Restraining.  
Plastic shapes =- Promoting .....
4. Returning to the Starting Point =- Restraining.  
Progression =- Promoting flux .....
5. Stable relationships =- restraining flux.  
Labile relationships =- promoting flux .....
6. Peripherals are restraining; transversals are promoting.
7. Regular rhythm is restraining; irregular rhythm is promoting.<sup>2</sup>

---

2. R. Laban, Choreutics, pp. 208-209.

It is necessary to consider the above points in detail and to discover in what way they are utilised in dance.

1. Dimensional movement is orientated within an imaginative octohedral structure.

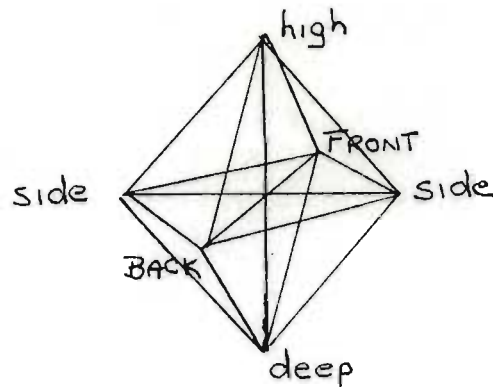

Fig. 11

Height and depth is a vertical axis corresponding to the spine of the body. Physically the spine is not straight. It consists of four curves which are alternatively convex and then concave. The manner in which the spinal curves balance each other allows for the upright carriage of the body.

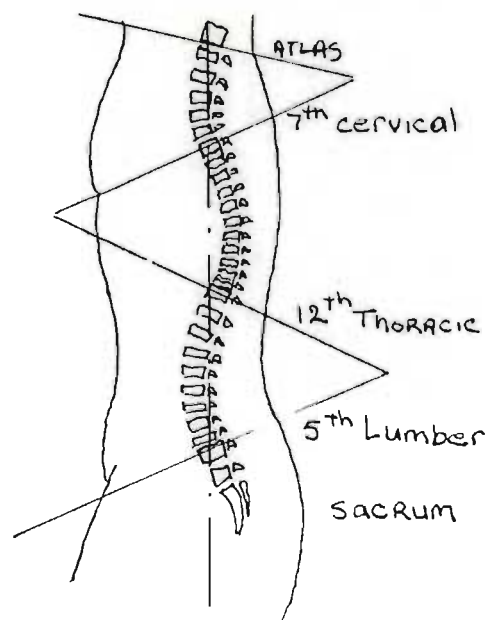

Fig. 12 Redirection of Curves and Subtended Angles<sup>3</sup>

3. Mable Todd, The Thinking Body, p.96.

The flexible curves in the spine are utilised in a simple way when the movement is ocothedrally orientated. For example, movement from to simply increases and decreases the spinal arcs. This movement is appreciably small, and the central vertical axis maintains its relation to the curves as shown in Fig. 19. Therefore the balance and the relationship of certain body parts (the head, thorax and the hip girdle) remains the same; the balance of the body is not disturbed. The relatively small amount of neuromuscular activity does not make this movement and excitable one. However, with the compression of the spine in a downward direction there is an increased tension in the muscle centres. This may be illustrated in the following diagram :

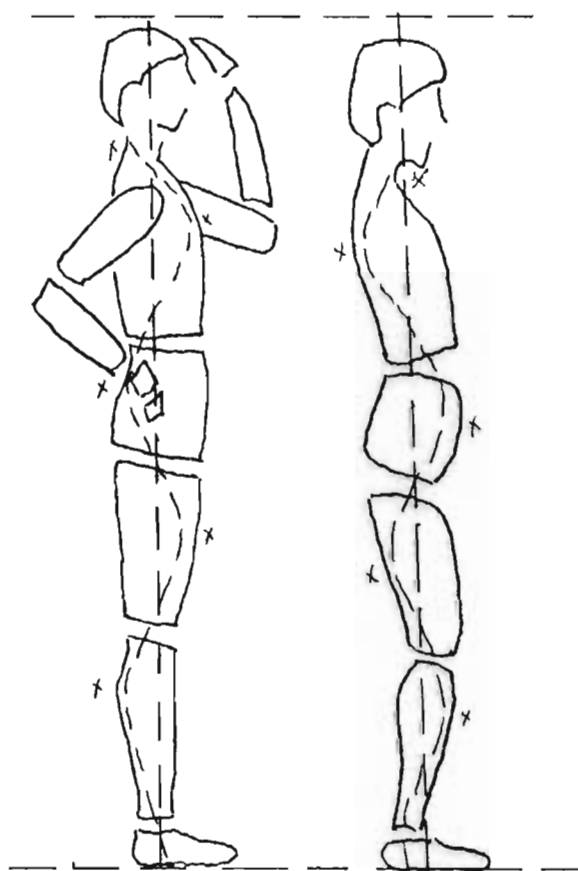

Fig. A

Fig. B

Fig. 13

In the first figure the natural distribution of tension is held



through opposed muscle centres, that is, the muscles of the calves, the thighs, the buttocks, the chest and the base of the neck. In the second figure the opposing muscles are tensed in order to maintain the balance of the body. In a downward movement an increased muscular tension gives the mover a kinaesthetic sensation of weight. In an upward movement a decreased tension in the muscle centres gives to the mover a kinaesthetic sensation of buoyancy. In dance these sensations have to be symbolically presented in both the secondary illusion of spatial design (i.e. compacted space or extended space) and in the flow of the dynamic stress towards increased tension or decreased tension. Restricted movement within this dimension may be imagined as existing within an upright tube, the inside volume of which undergoes compression and expansion.

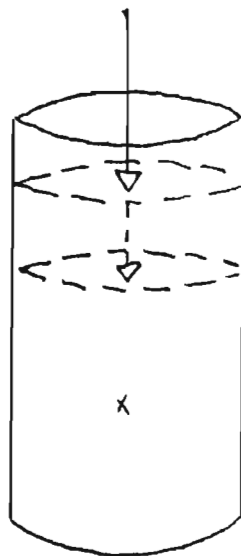

Fig. 14

Density increases with movement downwards and decreases with movement upwards

Because the major weights (the head, chest and pelvis) remain centred over the support, the body does not have to recover from a movement towards high or deep with a movement in a new direction, thus change is not promoted. In considering the above movement as an act, it is clear that its inhibiting and releasing factors are confined to a single dimension of space and to a single continuum of quality.

Movement along the horizontal axis has a similar function, except that it is effective in opening and closing the body. The movement occurs in an horizontal plane around the vertical axis of the spine which is used in a twisting action. This has only been made possible by the biped position of the body of man. It gives a wider range of movement to the joints of the hips and it also allows the arms to articulate a broad sweep in space. 'No quadruped can move his fore and hind legs so far from centre to either side as man, nor can many of them move the limbs much above the back.'<sup>4</sup> With the upright position of the body there is a corresponding shift from the dependence on the sense of smell to that of the sense of sight, this is mainly because the visual arc is increased in this position. Furthermore the development of the hand as a sensory perceptor, together with the increased dependence on sight, has enabled man to realise a world of forms, which are functionally known through touch and sight. This knowledge of forms has led to aesthetic perception, which is a mode of consciousness and felt as an attitude. Thus the functional aspect of movement leads, in man, to an expressive and projective ability. Movement of an opening and closing nature along the horizontal plane entrains, because of evolutionary development and through the use of the limbs towards and away from the vertical axis, acts of perception. Laban has defined perception in terms of two modes, namely that of fixed focus of attention and secondly, that of the constantly refocusing of attention. The spine is only capable of twisting along its vertical axis to a limited degree. The more the spine becomes twisted the more inhibited is the range of movement in space; thus movement that is enclosing (decreasing the spatial range) is accompanied by a decrease in the focus of attention. Movement that is untwisting or opening is

---

4. T.M. Todd, The Thinking Body, p.98.

accompanied by a refocusing of attention. Because of the bilateral structure of the body and because of the balanced structures of the shoulder and pelvic girdles, there is a tendency to maintain this balance in movement in the horizontal plane by compensatory movements on the side of the body that does not initiate the main action. Because of the compensatory movements in the same plane, there is no need for a recovery in a new plane or along a new axis of orientation. Change is inhibited.

Finally, the forward and backward dimension uses the spine by articulating the spinal arcs. There are two major areas of articulation along the length of the spine, they are the cervical and lumbar curves. The third cervical and the fourth lumbar vertebrae are apexes of these two curves. Movement into a forward direction has the effect of decreasing the major thoracic curve (between the seventh and twelfth thoracic vertebrae) and the cervical and lumbar curves compensate by flattening towards the horizontal. In this way the abdominal area is increased.

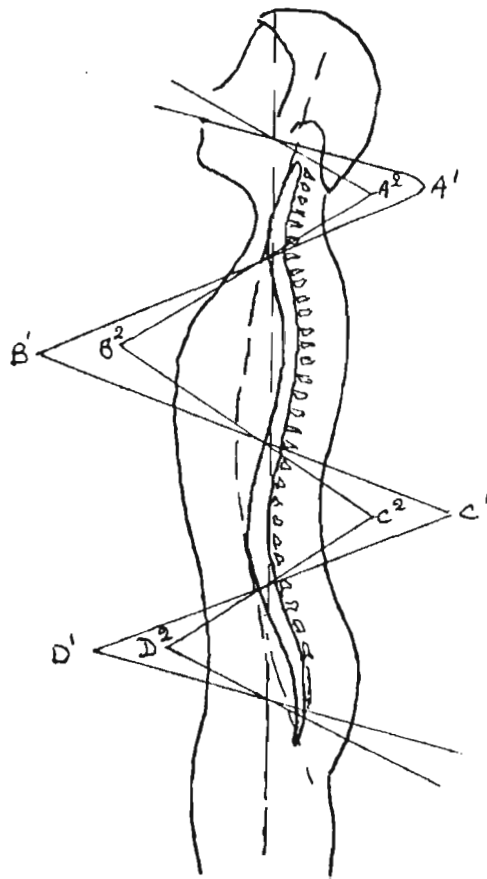

Fig. 15 illustrates the increase of the cervical curve from  $A^1$  to  $A^2$ ; and in the lumbar curve from  $C^1$  to  $C^2$ . The compensation for this increase in curvature is met in the opposing angles  $B^1$  and  $D^1$ . Because of this compensatory factor within the same axis, change is not promoted. Movement that increases the cervical and dorsal arcs, brings the dorsal spinous processes closer together and at the same time increases the gap between the main disc-like body of the vertebrae.

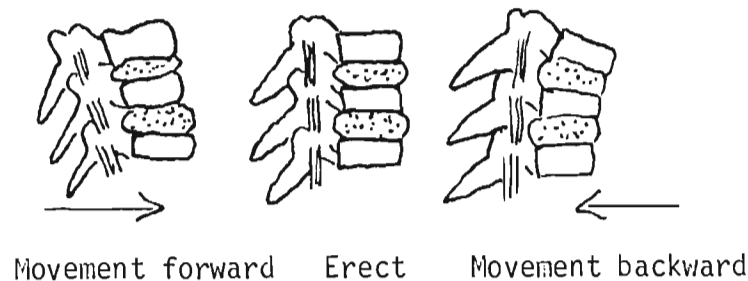

Fig. 16

A sudden or quick movement into a forward direction is more of a strain to the muscles, ligaments and fascia around the vertebrae than is a sustained movement in this direction. Besides this factor, a sudden exposure of the unprotected area between the ribs and the pelvis is experienced as an increased exposure of the abdomen to attack from the environment. Thus sudden movements have a natural tendency to be performed along the backward axis, and sustained movements along the forward axis.

The human body as a dynamic living entity is also capable of exerting opposing forces on the muscular-skeletal structure through the

exertion of energy. In this way the balance of the skeletal structure may be brought about by using energy and not only by compensating in the re-distribution of the weights along the spine.

Movement within the octohedron makes a comparatively small demand on the use of energy in maintaining the balance of the body. This is contrasted in movement that takes place within the imaginative structure of cubic space.

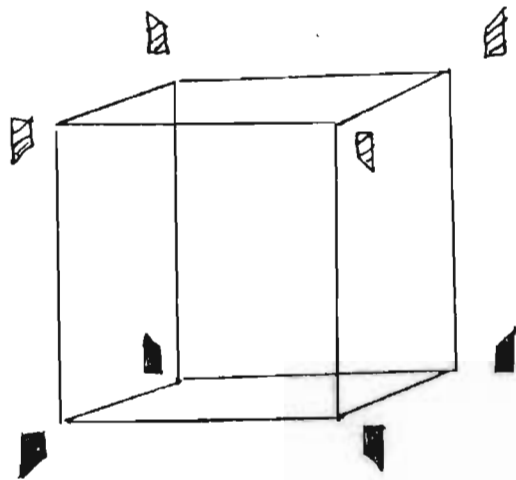





Fig. 17 The Spatial Cube

Movement along the diagonal, towards the corners of the cube, has the effect of pulling the body's centre of gravity away from the vertical axis. Thus the main skeletal weights are no longer able to compensate for this type of imbalance. It is for this reason that energy becomes the main factor in promoting and inhibiting the action. Thus there is a developmental shift away from the functional and partially mechanical tendency of octohedral movement towards expressive muscular activity. There is an increased possibility of movement entraining feeling as a necessary sequent because of additional muscular activity. This will be discussed in terms of the extended use of the three major axes and the type of kinaesthetic response that is naturally induced.

1. The main axis in the cube is that of  and . When the body moves towards , the spine twists, rises and moves forward, thus all three axes of the spine are used simultaneously. The movement is controlled by both the deep muscles of the back (the M. longissimus capitas, and the M longissimus thoraxis, the fascia lumbodorsalis) and by the trapezius, latissimus dorsi and the rhomboids. The muscles of the front of the body may also be used, for example, the rectus abdominus, the transversalis, the internus abdominus oblique and the externus abdominus oblique. In the progression of the movement towards the diagonal, the force of gravity overcomes the power of muscular exertion and the body falls. In order to prevent this, a diagonal movement will be followed by a stable<sup>5</sup> movement, that is, one that is orientated within the octohedron.

2. It is also possible that recovery is achieved by a movement into a new diagonal. This requires a major readjustment in the muscles as well as a change of focus, tension and speed. If the recovery from one diagonal direction is achieved by moving into its opposite diagonal pole, then the movement has a pendulum effect, that is, once the momentum or original impulse is spent the movement comes to rest on balance. Thus the potential for change is diminished if the movement remains within the same diagonal.

3. Promotion and inhibition of flux or change finds a natural interplay in movement orientated within the Icosahedron.

---

5. See R. Laban, Choreutics, p.199.

'Stable' should not be taken to be static and motionless. We look upon it as that element which leads movement to quiescence and stillness, which causes a movement theme to fade out and to find a conclusion in itself without anticipation of a new theme. Spatially, its opposing tensions firmly weld the equilibrium of forces.

Referring to the conception of our personal space as a sphere and imagining a cube inside this sphere, we shall find that the cube will touch it with its eight points, between which six equal square planes extend forming its faces.

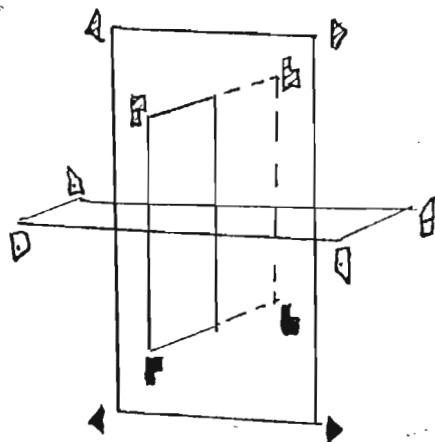

Fig. 56

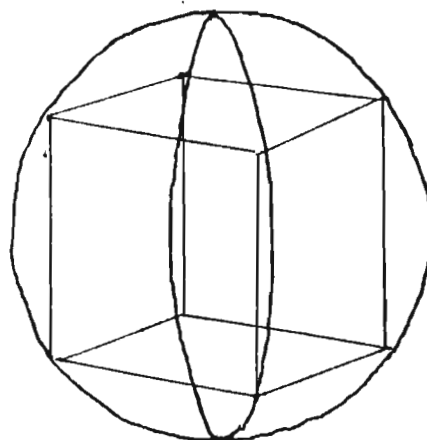

Fig. 57

Fig. 18

If, however, we picture the three rectangular dimensional planes within the sphere, we see that their twelve corner points (four points of each plane) touch the sphere (Fig. 58). Between these extend twenty equilateral triangles as boundary faces, thus forming an icosahedron. This provides far greater detail of orientation than the cube. A scaffolding has been created whose boundaries approaches a sphere much more than the less differentiated cube (Fig. 59).

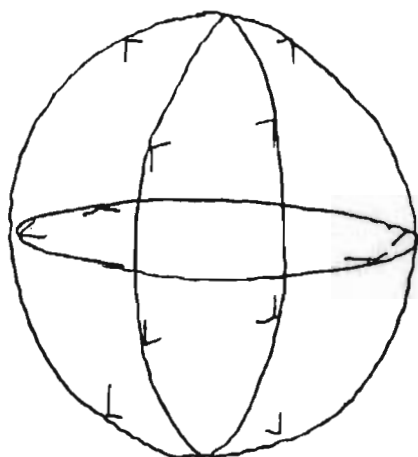

Fig. 58

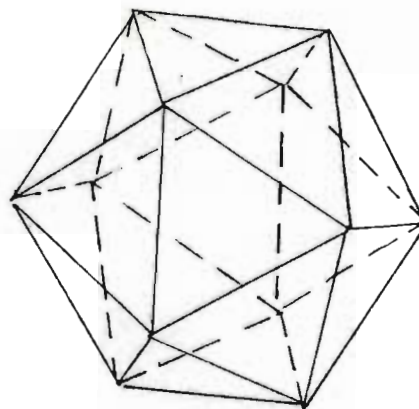





























Fig. 59













6

Fig. 19

Movement in the icosahedron may be peripheral, radial or transversal. The transversal inclinations are characteristic of icosahedral movement, whilst peripheral and radial movement may take place in movement orientated in all three imaginative spatial structures (the octohedron, the cube and the icosahedron). Inclinations bypass the centre of the body, and require a greater control and a finer balance of muscular tension than do radial or peripheral movement.

Each diagonal may be deflected past the centre of the body in six different ways. For example the diagonal may be deflected by influencing it with dimensional orientation in the following manner :

- |    |                       |   |   |   |                   |   |   |
|----|-----------------------|---|---|---|-------------------|---|---|
| 1. | Predominant influence |    |    |   | give transversals |    |    |
|    | Secondary influences  |   |   |   |                   |   |   |
| 2. | Predominant influence |  |  |   | give transversals |  |  |
|    | Secondary influences  |  |  |  |                   |  |  |
| 3. | Predominant influence |  |  |   | give transversals |  |  |
|    | Secondary influences  |  |  |  |                   |  |  |

Transversals 1, 2, 3 are steep, flat and flowing respectively. The two steep transversals pass one in front of the body and the other behind the body. They also seem to have a preferential directional flow in performance.  to  flow from the highest extreme  to  which is not the deepest point in our reach, and  to  flows from the deepest point in our reach to  to  which is not the highest point in our reach. In moving from  the recovery is felt towards either  or  and is not experienced towards . This points to an interesting factor in the flow of action, and which has already been pointed out in the nature of acts. That is the



phrasing or the flow of movement, within an act, does not have its conclusion in the opposite extreme of qualitative and directional flow but maintains, in its conclusion, some of the influence of the climax. If this were not so, growth and development would not occur. A qualitative and directional opposite in the conclusion would create a homeostatic 'en passe'. Furthermore, all acts are built on the tone of the underlying sub-acts, in such a way that the sub-acts support the super-act rather than creating a polar opposite to the super-act. Thus the flow of movement in the transversals has a natural tendency to go from extreme extension to a diminished extension in a deflected directional opposite.

In creating plane-like movement, through the use of transversal and peripheral inclinations, the flow of movement from plane to plane is restricted. This may be demonstrated in terms of transversal two rings.

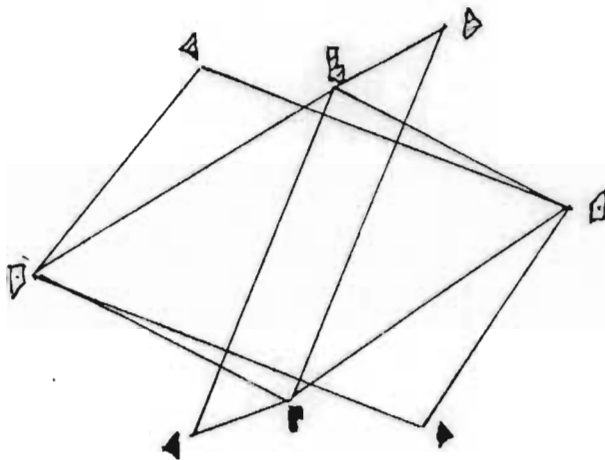

Fig. 20

When these two rings form a total system it is necessary to introduce a new element in order to move into a different plane.

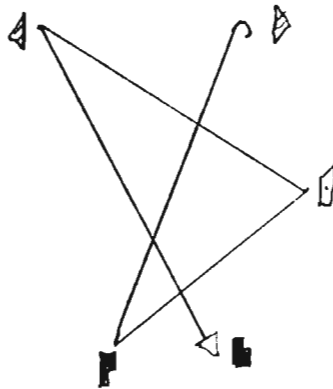

Fig. 21

The two transversals of each two rings are derived from the same diagonal. It is only when a new diagonal influence enters as an attracting or repulsing force that movement becomes plastic and hence promotes change. This new diagonal influence enters the action as a new charge which heightens the potential of the movement towards a new direction. This demonstrates another characteristic of movement within acts and that is, locally developed energies, in this case the twisting or opening, stretching or bending, advancing or retreating complexity of the diagonals with their deflections, have particular paths of release. This knowledge is essential to the choreographer because recharge and lability may only be symbolically projected in terms of directional changes with their innate local energies. An

example of a plastic flow of movement is given below.

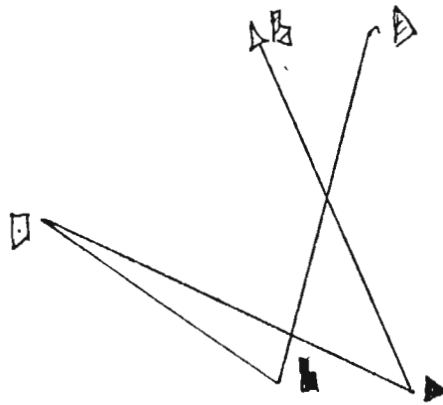













Fig. 22

The first two transversals,  to  and  to  are derived from the diagonals   +  . The third transversal has been influenced by the new diagonal direction  , the fourth transversal continues as a steep deviation of the same diagonal,  .

4. In performing a movement sequence, a return to the starting point inhibits change. This is fairly obvious in that there is a return to **the** original charge or impulse of the phrase. It follows that a movement sequence which is constantly influenced by new polar direction will promote change.

5. Stable relationships between movement directions are characterised by the isolation of one direction from another. All transversals in the icosahedron have a parallel opposite which flows in the opposite direction. Some transversals are related to one another by virtue of their common axis. For example, all the transversals of the cluster in Fig. 23 are related through their common axis .

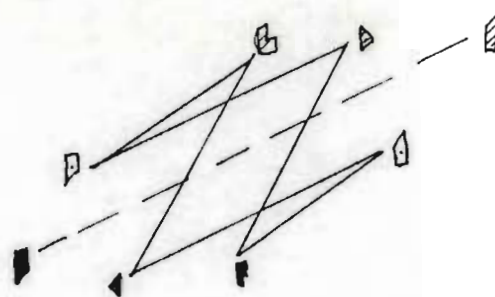

Fig. 23

Therefore the twenty-four transversals may be grouped into four sets of six. Transversals in the same set are closely related and because of their common diagonal axis, have a stable relationship. The relationship between transversals of different sets have a labile relationship because of their different axes.

6. Peripheral movement, in the form of five rings and equator rings, does not promote change because the rings circumvent a single axis and they are performed at the periphery of the kinesphere which inhibits the recharge of energy. The impulse for this movement is felt in a gathering towards or a scattering away from the centre of the body.

7. A regular pulsation of similar quality does not promote change because of the continuous projection of the same qualitative impulse. Irregular rhythms, with their variation and opposition of changing impulses, promote change.

In dance, where there is a symbolic projection of organic growth and development, a constant dialectical interplay between those factors that promote change and those factors that inhibit change, occur. This is constructed in such a way that change or growth is usually followed by a stabilising theme. This follows the individual's experience of image making in life itself. Stimulation is followed by consolidation through

the image, which, in art, is symbolic of the sensual experience.

Every movement of the dancer, whether it be a complete movement theme or a subordinate element within that theme, should exemplify the basic act form. The above description has shown that even in the analysis of the elements of spatial direction and quality the basic act form may be observed.

Another consideration of the choreographer is the presentation of the dance, the single symbolic unit, to the audience. This involves the principles of presentation of the symbol.

In dance, presentation may be broadly divided between representation and manifestation. Representational dance is concerned with presenting content as an issue which tends towards realism and description. It appeals towards the more or less objective mode of perception and tends to give knowledge about a specific situation or character. Manifestive dance on the other hand is concerned with feelings and felt values. It is more subjective. The audience is required to use an imaginative mode of perception. Both these ways of presentation are of value, but for dance to exist as a unique art form, representational elements should be used as sparingly as is possible.

Certain subjects may demand more representational elements than others, for example, Sir Fred Ashton's work The Dream where a considerable amount of pantomimic and realistic movement is used together with realistic properties, such as the donkey's head. There are representational dances of another kind, namely those concerned with themes. Here action as well as feeling become the subject matter. They are dramatic in that the emotional content of the dance finds its cause in the situation. There are many gradations in this mode of presentation, perhaps the greatest

works being the dance-dramas of Martha Graham. Most of her inspiration has come from mythology and she has created movement, mythic symbols which evoke and direct psychic energy.

Clytemnestra, the creation generally accepted as the high point of her work as an artist, offers perhaps the best illustration of her particular approach to time, plot and character. When the curtain rises on Clytemnestra the audience finds her already in the Underworld; she has come to 'that most deep and subterranean end of wandering'. Yet, even in Hell, Clytemnestra remains true to the exigencies of her fiery nature and we see her, in the first act, defying the very King of Hades himself. Why, she demands to know -- by movement, not words, of course -- is she being so terribly punished when she has in fact, done nothing worse than any of the other participants in the fateful drama that began -- or did it? -- when her beautiful sister Helen, was abducted by Paris and thus started the tragic Trojan war? 7

Character and situational motive are present in the dance drama. Because the plot does not show a consecutive use of time, in terms of events Graham manages to focus the import of the symbol towards the inner state of the character rather than towards the unfolding of plot. Graham's use of properties are invested with symbolic and dramatic meaning.

The cape in Clytemnestra is a supreme example of inspired, non-literal use of an object to heighten drama and advance plot. The extravagant length of cloth used by Clytemnestra as a magnificent queenly robe serves also as a curtain for a doorway opening on doom; she herself offers it as 'the royal purple' for Agamemnon, the arrogant returning hero, to tread underfoot; and lastly, it becomes the funeral drapery of the cart which carries away the victims of her vengeful range.' 8

Manifestive dances may again be divided between dances of action and those of mood. Action dances do not present specific happenings, rather the movement is structured with the intention of communicating the dynamic import of movement for itself. The kinaesthetic and spatial

---

7. Nancy Wilson Ross, Introduction to the Notebooks of Martha Graham, p.xii.

8. Nancy Wilson Ross, Introduction to the Notebooks of Martha Graham, p.xiii

'image' is imparted directly without any other references. Dances of mood show movement as symbols of emotions and 'inner states'. The structure of the dance is designed according to the logical flow of feeling experienced in life.

The four categories of presentation may be schematised as follows :

<u>Manifest Dances</u>	<u>Representational Dances</u>
<u>Action Dances</u>	<u>Thematic Dances</u>
Movement presented as :	Movement presented as :
Spatial Design and Quality	Situational action and feeling, character.
<u>Factors considered :</u>	<u>Factors considered :</u>
Spatial configurations	Relation of dancer(s) to environment
Tempo	Creation of character by a selection
Force of movement	of qualities of movement that are
Spatial design	symbolic of inner attitudes towards
(Straight and curved lines)	Motion Factors of Weight, Space Time
Flow of movement	and Flow, settings and properties.
<u>Type of dance :</u>	<u>Type of dance :</u>
Lyrical	Dance Drama
<u>Mood Dances</u>	<u>Dramatic Dances</u>
Movement presented as :	Movement presented as :
Feeling	Situational action, character and plot.
<u>Factors considered :</u>	<u>Factors considered :</u>
Attitudes towards	Creation of character through selection
Motion Factors of Weight	of action profile relation of character(s)
Space, Time and Flow.	to situation.
Overall Spatial design	Development of plot.
<u>Type of dance :</u>	<u>Type of dance :</u>
	Settings and properties.

The choreographer's concern, at this stage of creativity, is the selection of movement motifs, their organisation into a total symbol and their accurate execution. But for the dance to exist as an art form, movement must be used as a projection of feeling and not only as an activity performed for the sheer exhibition of the functioning structure.

Dance movements exist as acts that originate from spontaneous impulses, but they become modified by the informing mind as it moulds and relates their forms to the end that there may be unity between movement and whatever of thought and feeling they are to embody. The dancer is given unity in words and meanings. 9

---

9. M.N. H'Doubler, Dance a Creative Art Experience, p.135.



PART 3

THE ACT CONCEPT IN RELATION TO THE CREATIVITY OF THE DIRECTOR

CHAPTER EIGHT.  
THE NATURE OF DRAMATIC ACTS IN  
PERFORMANCE.

Whilst the primary illusion of dance is that of 'vital force', drama in performance creates the illusion of 'destiny'.<sup>1</sup> This is articulated through the inevitability of the completion of the form-in-the-making. The elements of drama are selected, in such a way that at their first presentation on the stage, the relations obtaining between them project, via the imagination of the audience, the final outcome. The future is constantly implied by the present action. This occurs because every component of the drama, from the speeches of each character to the feeling communicated by the tone of voice and movement, are selected acts which go to form the super-act. This constitutes the single symbolic presentation of the play.

Every act on the stage is significant and is determined by the total action of the play. The director's creative endeavour is the selection and guidance of all the elements of production so that the illusion of destiny becomes a reality at every moment of the play's unfolding.

Dramatic action, in both its visible and audible aspects, as well as the implied or symbolically projected aspects of feeling, emotion and belief, is a semblance of action in reality. The difference between reality and dramatic action is that every act presented on the stage is seen in its entirety. The cacophony and welter of irrelevant action that is confronted in everyday life obscures the future implications of lived actions. This is not so in drama. Through a selection of significant

---

1. S.K. Langer, Feeling and Form, p.307.

actions, the audience is able to follow a progression of acts from feeling, through emotion to articulate speech, thought and belief. It is in this aspect that the principles of organic growth and development are reflected in Dramatic Art. The selection and relation of acts to each other goes further than a mere symbolic projection of the life process. By constantly implying the future inevitability of actions begun, and by never losing the influence of the past, life is seen as a single reality. This view is the essential element in man's humanity. - it is the lived and thought experience of his individuality. Whereas in the animal kingdom the individual is separated from his ambient by a physical boundary, namely the skin, man is capable of extending his individuation beyond this physical boundary to include both physical objects and values as part of the matrix of his existence. The past and the future, even though they are virtual phenomena, are positive forces in the creation of his mode of existence in thought and action. It is in the Dramatic Art that this distinction of man's humanity is most clearly articulated.

The choreographer has to create his own movement script. The director is given a script by the playwright. It has been argued that the director is not a fully fledged artist because his function is merely to interpret the script. If he is called an artist at all, he is referred to as an interpretive artist, with the connotations of him being not truly creative but more of a skilled artisan. This is not so. In order to understand the process of creativity that the director undertakes, it is important to make a clear distinction between literature and drama.

Literature is firstly different from drama in its manner of presentation. The novel, the written poem<sup>+</sup> and the silently read play script<sup>++</sup>, are presented to the eye as the means by which we become aware of its existence. The means of communication between the author and the reader is via the written or typed word. Although prose and poetry, are able to evoke in the reader, through his understanding and imagination, a world of sound and action, it is not part of the mode of presentation itself.

Drama on the other hand, is presented in the theatre, where ideas are communicated via the spoken word, and feeling and emotion are symbolically projected through the quality of movement and speech. Literature implies action. In drama, it is actually and virtually present.

The second distinction may be made in terms of content. Literature is involved with history which may be factual as in a biography or fictional, as in a novel. History in this context does not mean a chronicle of events but a presentation of events in the experiential mode. The story in the novel, is often told through the impressions of a single character's perspective, for example, James Joyce's novel A Portrait of the Artist as a Young Man, or it is told through a few of the central characters. The illusion with which the novelist deals is of the creation of life being lived with virtual characters and virtual situations. It has already been stated that the content of drama is the immediate presentation of the processes of feeling and thinking through characters that are visibly present. It is not history,

---

+ Although poetry has its origins in the sung ballad, it may be considered as a literary form, in that its presentation on the written page has a visual impact which, when spoken, is transformed into a new media. The written organisation of many of E.E. Cummings' poetry is a case in point.

++ No playwright writes a play without having the intention of it being performed. If this is not his intention, it is not a play.

but a form of experience in the making which is constantly directed towards the future. Drama gives us the virtual appearance of destiny or fate.

The director is involved in the creative process of forming the virtual present. This is not contained in the script. He does this by creating the situation, which is the total complex of the unfolding play at every moment. The situation may only be articulated through the composition of acts. The playwright gives the words to the actors and may through the use of dialogue and stage directions, give an indication of environment, character, or even the movement to be used by the actor. The creation of the virtual present is controlled through the director's understanding of the play and his imaginative concept of its presentation. This concept and understanding is an original one in that the mode of imaginative thinking is not merely an analysis of the script as literature but is an envisaging of words as action supported by other acts of motivation. This mode of creative thinking is not given to the producer by the script directly, it is part of his own process of creative directing.

It has been argued that the presented drama is a synthesis of all the arts; poetry, music, dance, sculpture and painting being its ingredients. If this is so, then the director is not a pure artist in the sense that he does not work in a unique medium. To argue that, through a synthesis of other arts, a unique medium is created, is to confuse the function of poetry, music, dance and the fine arts in drama. A painting or a dance as a work of art in itself is not reliant on any other mode of expression for its artistic import. Other art forms, when used in drama are not presented for their unique mode of projecting feeling,

but are transmuted into the drama and are only significant insofar as they enter into the play as an element in the creation of the illusion of destiny. Langer has written

It is the painter (or architect, or sculptor) turned poet who understands the commanding form which the author has composed by writing the lines of the play, and who carries this form to the further state of visibility, and it is the actor-poet who takes the whole work-words, setting, happenings, all through the final phase of its creation, where words become utterances and the visible scene is fused into the occurrence of the virtual life. 2

Although the other arts may be presented in transmuted forms, the medium in which the director creates is unique in that it operates on the imaginations of the audience in such a way that all elements presented are a virtual embodiment of the playwright's intention.

In the process of imagining and creating the embodied play, the director has one paramount concern and that is the script. The playwright not only gives words to be spoken but should also, without being didactic, evoke images of those acts which give movement, action and life to the play.

In the argument between Aeschylus and Euripides in Aristophanes' The Frogs, Aeschylus puts forward the unity of idea and language and their embodiment on the stage :

---

2. S.K. Langer, Feeling and Form, p. 325.

Euripides : But did I invent the story I told of - Phaedra, say ?  
Wasn't it history ?

Aeschylus : It was true, right enough; but the poet should hold  
such a truth enveloped in mystery,  
And not represent it or make it a play. It's his duty to  
teach, and you know it.  
As a child learns from all who may come his way, so the  
grown world learns from the poet.  
Oh, words of good counsel should flow from his voice ...

Euripides : And words like Mount Lycabettus.  
Or Parnes, such as you give for choice, must needs be  
good council ? -  
Oh let us,  
Oh let us at least use the language of men !

Aeschylus : Flat cavil, sir !  
cavil absurd !  
When the subject is great and the sentiment, then, of necessity  
great grows the world ;  
When heroes give range to their hearts, it is strange if the  
speech of them over us towers ?  
Nay, the garb of them too must be gorgeous to view, and  
majestical, nothing like ours.  
All this I saw, and established as law, till you came and  
spoilt this.

Euripides : How so ?

Aeschylus : You wrapped them in rags from old beggarmen's  
bags, to express their heroical woe  
And reduce the spectator to tears of compassion.' 3

The argument given above is predominantly concerned with the  
nature of the verse, and not with its physical embodiment. It is  
only in Aristotle's Poetics that a theory of Greek Drama in about 335 B.C.  
becomes articulated. Theodore Shank says of the Poetics

Aristotle's view of tragedy as one of the 'various kinds' of  
poetry 'which imitates by means of language alone', as well as  
his treatment of the script as a complete work of art, precludes  
his considering drama as a complete work of art, precludes his  
considering drama as a single fine art. 4

Although this may be implied in the Poetics, it is a conclusion  
reached without a consideration of Aristotle's concept of 'action'. In

- 
3. Aristophanes, The Frogs, translated by G. Murray, 1.1050-1063.
  4. T. Shank, The Art of Dramatic Art, p.14.

Chapter VI Aristotle says after a discussion of spectacular elements, character, plot, diction, song and thought :

For tragedy is an imitation not of men, but of actions of life, and of felicity. For infelicity consists in action, and the end is a certain action, and not a quality]. Men, however, are persons of a certain character, according to their actions, they are happy, or the contrary. The end of tragedy, therefore, does not consist in imitating manners, but it embraces manners on account of actions; so that the action and the fable are the end of tragedy. But the end is the greatest of all things. 5

From the above quotation it is clear that all elements of dramatic structure should serve dramatic action. Tragic action is defined in the Poetics as Mimesis. Mimesis is translated in the English translation as 'imitation'.<sup>6</sup> Walter Kaufmann in Tragedy and Philosophy has suggested that this word does not require translation, but if it is translated a more accurate rendering would be 'pretending and make-believe' which bring to mind the role of the imagination. In this way dramatic action is not a copying of past events as is history, but an imaginative creation of action, which, although certain facts may be drawn from history, follow one another according to their ability to induce further acts of dramatic import. The first consideration that the director has with the script is the understanding of the lines in terms of sub-acts, acts and action, and the projection of this understanding in physical and virtual terms.

It is necessary to analyse the concept of action, act and sub-acts still further. The analysis will move from the larger to the smaller as is customary in all analyses, however, the process of creativity for the director is in exactly the reverse order. He must begin with the smaller units so that each act of its own accord induces the one following. If

---

5. Aristotle, Poetics, Chapter VI in European Theories of the Drama, by Barret H. Clark, p.9.

6. W. Kaufmann, Tragedy and Philosophy, p.42 and discussion on pp. 43-46.



he does not do this the final production will be marked by forcing the sub-acts towards his own conception. He must continually be guided by the script at every stage and not bend the elements of his art towards his abstraction of the import of the play. Dramatic import only exists in the physical embodiment of drama which grows from sub-acts, through acts of feeling and idea, to action which is the virtual revelation of destiny.

Firstly, action requires definition in tragedy and comedy, the import being different in the two modes of drama.

Aristotle says that for action to be tragic it should evoke from the audience 'eleos' and 'phobos'. These two words are most commonly translated as 'pity' and 'fear'. At the outset it was stated that the feeling that is projected from the stage is not feeling in the same sense that it is experienced in every day life. In art, especially in dramatic art, feeling is articulated by means of its form. In each art form, feeling is expressed through different media and therefore the form of the feeling is different. In drama the audience's response is not to the real feeling and emotion of the actor, but to the form of the feeling projected by the actor. The form of feeling is not a clinical abstraction but it is a selection of relevant detail necessary for the completion of an act. If the real, individual feelings of the actor were presented then the fabric of the play would become diverse, random and incapable of moving towards the inevitable conclusion. The response of 'pity and fear' then, cannot be the pity that we express towards another human being in real life. On the stage we are not presented with flesh and blood human beings, but with virtual characters which are created through movement and speech. Private emotions can only evoke personal responses

which will be diverse and individual. The selection of acts, which in themselves seem to embody feeling, is on the other hand able to evoke a more universal compassion between all men. Kaufmann has expressed this as follows 'The tragic emotion is not pity but what Goethe's Faust says as he sees Gretchen in the dungeon, out of her mind: Der Menschheit ganzer Jammer fast mich an (line 4406) - we feel seized and shaken by the whole misery of humanity.'<sup>7</sup>

In his Rhetoric (347-343 B.C.) Aristotle gives the following explanation of the nature of Fear :

'Now, let fear be defined to be "A sort of pain or agitation, arising out of an idea that an evil, capable either of destroying or giving pain, is impending on us.'<sup>8</sup> Kaufmann again argues that a more accurate translation of phobos should be that of 'terror'.<sup>9</sup> Now whether it be fear or terror, it is unlikely that the audience is directly terrified of the action on the stage. If they were they would flee from the theatre. It is obvious that this terror is of a very different kind. The action of the play is a projected symbol, it is not reality, therefore the audience's terror is not that of life but more a response to the import. As such it is imaged and therefore tolerable and at the same time it extends beyond the personal threat to that which threatens human existence, not only in terms of the individual's physical existence but also in terms of the values and beliefs which form part of the matrix of life. Tragic action is therefore, not created nor apprehended as reality. The director and the actor have to select from life those elements that are significant for dramatic action and create from them a completed whole, which unfolds through a progression of time.

---

7. W. Kaufmann, Tragedy and Philosophy, p.53.

8. Aristotle, Rhetoric, Chapter V, p.

9. W. Kaufmann, Tragedy and Philosophy, p. 54.

Tragic action is embodied in the plot and the main agents in the plot are the characters. Plot and character may not be considered separately. The plot is revealed through the relation of the main protagonist to his destiny and the relation of the characters to each other. The hero is not presented on the stage as an abstracted symbol of humanity, he is embodied and distinct from any other character on the stage. He is an individual. There is, however, a distinct difference between the individual personalities that are met in everyday life and that of the character as an individual. The character that is presented on the stage is the total personality, it is not a fragment of him, nor is it an enlargement of symbolic humanity. The tragic hero is, through the unfolding of the play, a completed artistic whole. What the character might or might not have done prior to the commencement of the play or what he might have done in different circumstances, is hypothetical conjecture that has nothing to do with the understanding of the character. The relation of the character to his destiny is not that of a decisionless, helpless individual to an outside manipulative force. The fate of the 'character - individual' is what he is and therefore what he does despite the circumstances that the play demands of him. The tragic hero uses all his powers to act in meeting these demands and during the course of action he suffers in exhausting those powers.

The tragic hero is committed to action. Every action is the impetus for another act, until, through accumulation, the dynamic rhythm of the play is formed. The tragic rhythm is that of growth, full development and decline; it is organic. The art of the dramatic form is seen in the transference of the rhythm of natural organic life to that of the created 'character - individual', who is characterised by mental and emotional growth, full maturation of these powers and the final exhaustion

of his virtual life. Because the protagonist is only that which the dramatist has made of him, it is possible for the whole character to be concentrated in one aim and one conflict. Thus in the climax of the conflict the audience senses that every element in the play has been moving towards this point. Langer makes this clear.

Drama is not psychology, nor (though the critical literature tends to make it seem so) is it moral philosophy. It offers no discourse on the hero's or heroine's native endowments, to let us estimate at any stage, in the action how near they must be to exhaustion, the action itself must reveal the limit of the protagonist's powers and mark the end of his self-realisation. And so, indeed, it does : the turning point of the play is the situation he cannot resolve, where he makes his 'tragic error' or exhibits his 'tragic weakness'. He is led by his own actions and its repercussions in the world to respond with more and more competence, more and more daring to a constantly gathering challenge; so his character 'grows', i.e. he unfolds his will and knowledge and passion, as the situation grows. His career is not change of personality, but maturation. When he reaches his limit of mental and emotional development the crisis occurs; then comes the defeat, either by death or as in modern tragedies, by hopelessness that is the equivalent of death, a death of the soul, 'that ends the career'. 10

The playwright in creating an illusion of destiny is not giving an illustration of the workings of 'fate' as some supra-power in real life; dramatic illusion of destiny belongs to the play and is the inevitable progression from act to act. Fate is embodied in action and does not control action from without.

Comedy : 'The first point to which we should call attention is that there is no comic outside of what is exclusively human. A countryside may be beautiful, graceful, sublime, insignificant, or ugly; it will never be comical. We may laugh at an animal, but only because we have caught it in an attitude of man, or a human expression. We will laugh at a hat; but what we scoff at, then, is not the piece of felt or straw; it is the form that men have given it; it is the human whim from which it has taken shape.' 11

---

10. S.K. Langer, Feeling and Form, p. 358.

11. Henri Bergson, Laughter in Dramatic Theory and Criticism, p.737.

Henri Bergson's essay on Laughter (1900) demonstrates one essential factor in comedy and that is that it is about man, and not merely situations or things. The actions of man, with all his human qualities, in confronting the chance opportunities that life offers him, is the material for comedy. The form that the character creates in his actions of self-preservation, is comic.

The form of the action in comedy is of a particular kind. Bergson, in his essay on Laughter, contends that the basic ingredient of comedy is the inappropriate use of muscle and mental power by an individual to a specific incident. He calls this a superimposing of the mechanical over the living -- 'something mechanical inlaid on the living'.<sup>12</sup> -- 'Any arrangement of acts and events which, when they are in close juxtaposition, gives us the illusion of life and the distinct feeling of a mechanical composition, is comic.'<sup>13</sup> Koestler has criticised Bergson's theory as an explanation of all forms of the comic. He says that Bergson failed to see that the same logical pattern could be converted from a comic response to a tragic or purely intellectual one 'by a simple change of emotional climate'.

According to Bergson, the main sources of the comic are the mechanical attributes of inertia, rigidity, and repetitiveness impinging on life; among his favourite examples are the man-automation, the puppet on strings, Jack-in-the-box, etc. However, if rigidity contrasted with organic suppleness in itself, Egyptian statues and Byzantine mosaics would be the best joke ever invented. If automatic repetitiveness in human behaviour were a necessary and sufficient condition of the comic there would be no more amusing spectacle than an epileptic fit; and if we wanted a good laugh, we would merely have to feel a person's pulse or listen to his heart-beat, with its monotonous tick-tack. If 'we laugh each time a person gives us the impression of being a thing' (Bergson, 1916, p.59) there would be nothing more funny than a corpse.<sup>14</sup>

---

12. Henri Bergson, Laughter in Dramatic Theory and Criticism, p.741.

13. Henri Bergson, Laughter in Dramatic Theory and Criticism, p.741.

14. A. Koestler, The Act of Creation, p. 53.

Koestler gives the following explanation of laughter

The sudden biassociation of an idea or event with two habitually incompatible matrices will produce a comic effect provided that the narrative, the semantic pipeline, carries, the right kind of emotional tension. When the pipe is punctured and our expectations are fooled, the now redundant tension gushes out in laughter, or is spilled in the gentler form of the sou-rire. 15

Thus it is not only the form of the action that is comic, (the biassociation of two unlikely ideas or events) but there should be an added criteria and that is the 'right kind of emotional tension'. This kind of emotional tension is brought about, says Koestler, by the presence of 'aggressive-defensive or self asserting tendencies'.<sup>16</sup> That is the form of comic action must allow the audience to perceive the ridiculousness of the action in the situation and thereby express its own superiority.

This concept of the comic has one major pitfall which lies in its application to the situation in the theatre. Since both character and action are virtual, that is, there is an imaginative perception of the total situation, it is unlikely that the audience is genuinely moved to laugh through realising its own superiority (a condition of the real, lived life) over the artistic and virtual presentation of life. Koestler has made a confusion between the perception of situation in life with that of art. In art the comic is intended and therefore the audience can hardly feel superior. That which provokes laughter in art does so only in terms of its ability to induce new or inhibit other on going acts, within the play itself. 'It is not what the joke happens to mean to us that measures our laughter, but what the joke does in the play.'<sup>17</sup>

---

15. A. Koestler, The Act of Creation, p. 52.

16. A. Koestler, The Act of Creation, p. 53.

17. S.K. Langer, Feeling and Form, p.348.

Thus comedy does not supply the audience with an opportunity to express its self-assertive tendencies but it is a celebration of man's vitality as he engages in the battle with the chance opportunities that the world springs upon him. The comic character, therefore, is not spurned as beneath us, but loved because he expresses the image of 'livingness'.<sup>18</sup>

The director's creative function, then is to present in terms of acts the virtual perception of the vitality of the comic stage-life. Comedy does not separate, it unifies. It arose as a community expression in fertility rites, which for the primitive man was an enactment of the biological procreation of life and which for modern man is an expression of that same excitement of triumphing over a world that appears to offer its opportunities in a random and diverse manner.

The playwright in his conception of the tragic or comic mode, makes certain creative choices, and he presents these choices in terms of the written script. The director makes further creative choices in his presentation of the script as drama on the stage. His choices are directed by his understanding of tragedy or comedy and by the choices already made by the playwright. His creation is that of a virtual appearance of the vital excitement expressed in the struggle to sustain life, which is the comic mode, or the creation of the virtual appearance of 'destiny' in its inevitable progression towards death or exhaustion, which is the tragic mode.

---

18. S.K. Langer, Feeling and Form, p.348.

CHAPTER NINE  
THE PROJECTION OF THE TRAGIC VISION.

The style in which the director presents a play is influenced by the philosophical values held by the playwright, and by those which are current at the time of the director's presentation. True artistic drama transcends historical and geographical boundaries in its total import, as stated in the previous chapter. The differing specific structures of drama and the values which emerge from these different approaches are specific to the playwright and to the age. In order to understand these different approaches, it is necessary to investigate a few of the major trends in the construction of a play and relate these to the changing values that theorists and philosophers have given to the dramatic art itself. The following survey is not intended to be comprehensive, but is included as an outline of some of the considerations a director should examine in understanding a script. This outline will deal with some aspects of the differing forms of drama in relation to the act concept as being an organic structure in art.

In considering the playwright's philosophical values, there is often a tendency to interpret the script as a vehicle of didactic thought, in which the playwright has no other concern than to present his world view to the audience, and to persuade them to accept it. The didactic play does exist, but if it merely exists in a philosophical dimension, then it is not drama nor can it ever exist rightfully in the theatre. On the other hand the script that functions only at the level of artistic arrangement, without philosophical content, must be considered as escapist entertainment. Thus the playwright, in creating true drama, presents his world view through the larger mode of symbolic projection, which embodies the sensuous elements of entertainment interwoven with idea.



George Steiner in The Death of Tragedy gives a definition of tragedy that clearly expresses the relationship between the sensual, social life and the tragic vision.

Any realistic notion of tragic drama must start from the fact of catastrophe. Tragedies end badly. The tragic personage is broken by forces which can neither be fully understood nor overcome by rational prudence. This again is crucial. Where the causes of disaster are temporal, where the conflict can be resolved by technical or social means, we may have serious drama but not tragedy. More pliant divorce laws could not alter the fate of Agamemnon; social psychiatry is no answer to Oedipus. But saner economic relations or better plumbing can resolve some of the grave crises in the dramas of Ibsen. This distinction should be borne sharply in mind. Tragedy is irreparable. 1

The work which has had the greatest influence on Western drama, is that of Aristotle's Poetics. With regard to action, he has written that it is the most important aspect of tragedy. The famous quotation that 'Tragedy is an imitation of action' has evoked centuries of discussion. It is, however, necessary to state this quotation in full as the qualifying phrases of the definition are all important.

But it is granted to us that tragedy is the imitation of a perfect and whole action, and of one which possesses a certain magnitude; for there may be a whole which has no magnitude. But a whole is that which has a beginning, middle and end. And the beginning is that which necessarily is not itself posterior to another thing; but another thing is naturally expected to follow it. On the contrary, the end is that which is itself naturally adapted to be posterior to another thing, either from necessity, or for the most part; but after this there is nothing else. But the middle is that which is itself after another thing, and after which there is something else. 2

- 
1. G. Steiner, The Death of Tragedy, p.8.
  2. Aristotle, Poetics in European Theories of the Drama by Barret H. Clark, p.10.

The first important aspect of the definition is the idea of 'imitation' and the second is that of 'action that is complete, and whole and of a certain magnitude'. Furthermore, these two ideas may not be discussed without relating one to the other. Tragic drama is not a sheer imitation of action in life, since action in life is not complete, nor whole nor all of a certain magnitude. Everyday activities are seldom completed without the interruption of some other unrelated sub-acts. Our consciousness in life is not solely directed towards a single facet of our existence. It is continuously moving in a dialectic manner between our biological, emotional and intellectual needs. Furthermore, the environment continuously offers haphazard and random stimuli which enter into our mode of thinking and existing, and so aid in fragmentising our actions into unrelated parts. Drama presents completed action. The playwright in drawing material from life, then, has to discard those acts that are irrelevant to, or which interfere with, the advancement of any one single act. Furthermore, every act should of its own accord, induce further acts or in the case of a sub-plot entrain the acts of the sub-plot to create an illusion of organic wholeness. Aristotle describes the beginning of an action as that which does not have a causal predecessor. In Aeschylus' Oresteia however, there is a causal beginning that precedes the first action of the play, and that is the curse on the house of Atreus. This is not action but knowledge and it is given to the audience through the chorus. The play opens with a watchman waiting for the lighting of a beacon, which will herald the successful return of Agamemnon from Troy. The description of the successive lighting of the fires as the news is passed from Troy to Argos, also creates the expectation of action.

In this way the audience is drawn towards the present and it is only in the present that dramatic action occurs. The play builds in tension from the first appearance of Clytemnestra, the antagonist; and with the arrival of Agamemnon, the protagonist, the sub-acts have built to the expected explosion, that is, Agamemnon's death, which is the climax of the play. In each of the three plays of the Oresteia there is only one climax, these three climaxes are so related to one another that they form one super-act. The Agamemnon deals with the murder of Agamemnon, the Libation Bearers with Orestes' matricide and the Eumenides with his acquittal. The climaxes of each play follow one another in such a way that the establishment of the supreme court of Athens, in the Eumenides, appears as the natural conclusion of the flow of dramatic action. It is not Aeschylus' plumbing trick to resolve the play, but it is the inevitable conclusion of suffering moving towards its exhaustion. The fact that the resolution of the Oresteia does not end badly, does not prevent the play from being tragic.

Before discussing the tragic plot, in terms of its conclusion, it is necessary to make a distinction between the action of the plot, and the actions of the characters. The action of the plot is not directly perceived through movement in space and time, it requires for its perception an abstraction of the 'idea' implicit in the total interaction of characters and an awareness of the development of mood, the gathering tension, explosion and resolution or dying away of that tension. Plot, therefore, may be described as an abstraction of virtual actions, from the actions of the characters in interaction, and a synthesis of these virtual actions into a developing organic whole. This organic whole is intuited rather than directly perceived. The immediate presentation of virtual action,

virtual in that it is complete and whole and not that of fragmentation found in life, arouses in the audience 'an active desire to know it (suspense)<sup>+</sup>, a desire that has been aroused by a previous stimulus'.<sup>3</sup> That is, not merely 'what will happen next ?' but 'what, how and when will it happen ?'. The awareness that a future event will take place is intuited by the audience in the present action. More important than the desire to know the particulars of future events is the creation of suspense. Suspense is created between the audience's intuited knowledge, that the action that they witness in the present is at the same time gathering further action in the future, and the character's lack of awareness of their present action. It is the suspense created by watching a character blindly walking into the future which the audience has already intuited to be threatening. The 'what' of the future may not be known, but its impending power as a threatening virtual presence in the present, is experienced by the audience.

The tragic plot may not be defined merely in terms of its ending. It has to do with the form of the action and its relation to character. Hegel has written :

That which pre-eminently is of valid force in ancient drama, therefore, whether it be tragedy or comedy, is the universal and essential content of the end, which individuals seek to achieve. In tragedy this is the ethical claim of human consciousness in view of the particular action in question, the vindication of the act on its own account. 4

Therefore, the conclusion must be looked at in terms of its 'content' rather than its resolution being confined to a fixed dictum of ending 'badly'.

---

3. Eric Bentley, The Life of Drama, p.13.

+ My insertion.

4. Georg W.F. Hegel, Dramatic Poetry, translated by F.P.B. Osmaston, pp. 532 and 533, From the Philosophy of Fine Art, Vol. IV in Dramatic Theory and Criticism.

In the Oresteia, Agamemnon's murder and Orestes' matricide are acts that are justified by Clytemnestra and by Orestes. This is however, a one-sided justification which does not accommodate itself, firstly to the 'universal and essential end' which they seek in these actions and secondly, to the concept of social justice. This is aptly put by Hegel :

For, despite the fact that individual characters propose that which is itself essentially valid. Yet they are only able to carry it out under the tragic demand in a manner that implies contradiction and with a one-sidedness which is injurious. What, however is substantive in truth and the function of which is to secure realisation, is not the battle of particular unities, however much such a conflict is essentially involved in the notion of a real world and human action; rather it is the reconciliation in which definite ends and individuals unite in harmonious action without mutual violation and contradiction. 5

The creation of the court of Athens is this reconciliation of the discordant individual acts. The tragedy lies in the course of action towards the resolution, in which those acts and characters which are unable to disengage themselves from their own particularities and justifications are compelled to destruction or resignation.

Sophocles' treatment of the mythical theme of Oedipus demonstrates this inevitable commitment to destruction and yet maintains the tragic resolution in harmony. Sophocles' central concern is the presentation of the illusion of destiny in Oedipus' sudden and unexpected fall from success and happiness. It is the original 'fall of man' re-stated in Genesis, Lear and in Job. All these treatments are concerned with the character's blindness to himself and the horror in the realisation of his true condition. The battle in Sophocles' play that exists between the unities, is contained in Oedipus' relation to his family and to Thebes.

---

5. Georg W.F. Hegel, Ibid., p.532.

The play opens showing the citizens of Thebes engulfed in despair because of a pestilence that has descended on the city and which is destroying all living things there. Oedipus is approached to save the city, as he did once before in solving the riddle of the sphinx. His task is to discover what has angered the gods to the extent of imposing a pestilence on Thebes, and to make amends. Oedipus sends his wife's brother, Creon, to consult the oracle of Apollo. Creon returns with the message that the city will be freed from the pestilence when the murderer of Laius, who was king before Oedipus, is found. Whereas in Aeschylean tragedy the action is perpetrated through mythical and social growth, here Oedipus himself initiates and maintains the action whereby his own 'sins' are brought to light. The conscious acceptance of truth is the mode of tragic expression in this play.

Oedipus, in discovering that he himself is responsible for the murder of his father, reveals the basic conflict of the plot.

The principle source of opposition, which Sophocles in particular, in this respect following the lead of Aeschylus, has accepted and worked out in the finest way, is that of the body politic, the opposition, that is between ethical life in its social universality and the family as the natural ground of moral relations. These are the purest forces of tragic representation. 6

In 'Oedipus the King' these forces are dynamically opposed in the relations between Oedipus and his family, he not only kills his father but marries his mother and fathers children that are his own sisters and brothers. Oedipus' definite end is the discovery of the truth which is directly opposed to the relationships he has with his family. In realising the true

---

6. Georg W.F. Hegel, *Dramatic Poetry*, translated by F.P.B. Osmaston, p. 538. From the *Philosophy of Fine Art*, Vol. IV in *Dramatic Theory and Criticism*.

nature of the relationship with his family, he is compelled to destroy the particularities of his marriage to his mother and by so doing the plot resolves itself in a non-contradictory balance.

The Roman playwrights are marked by their imitation of Greek drama. Horace advises writers to :

Either stick to tradition or see that your inventions be consistent. If when writing a play you introduce yet again the 'far-famed Achilles', make him impatient, hot-tempered, ruthless, fierce; he must disown all laws: they were not made for him; his appeal will be to the sword. In like manner let Medea be high-hearted and unconquerable. Ino tearful, Ixion a traitor, Io a wanderer, Orestes forlorn. 7

Throughout The Art of Poetry, Horace is more concerned with presentation than with form and he ensures that the play should always appeal.

The poet's aim is either to profit or to please, or to blend in one the delightful and the useful. Whatever the lesson you would convey be brief ... the man who mingles the useful with the sweet carries the day by charming his reader and at the same time instructing him. That's the book to enrich the publisher, to be posted overseas, and to prolong its author's fame. 8

Imitation as a principle of artistic creativity negates the concept of 'projection'. To follow Longinus when he writes On the Sublime

... it is well that we ourselves also, when elaborating anything which requires lofty expression and elevated conception, should shape some idea in our minds as to how perchance Homer would have said this very thing, or how it would have been raised to the sublime by Plato or Demosthenes or by the historian Thucydides ... 9

is to fall into the same trap as the Romantics did in their attempt to

- 
7. Horace, The Art of Poetry, translated by E.H. Blakeney, in Dramatic Theory and Criticism, p.70.
  8. Horace, The Art of Poetry, Ibid., p.74.
  9. Longinus, On the Sublime, translated by W. Rhys Roberts, in Dramatic Theory and Criticism, p.76.

imitate Shakespeare. Byron in a letter to Murray (Jan. 1821) wrote against the habit of imitation among English tragedians:

I am, however, persuaded, that this is not to be done by following the old dramatists, who are full of gross faults, pardoned only for the beauty of their language; but by writing naturally and regularly, and producing regular tragedies, like the Greeks; but not in imitation ... merely the outline of their conduct, adapted to our own times and circumstances, and of course no chorus. 10

At the same time projection is not the revelation of the self, or of the embodiment of personalised emotions of fear and grief in a created character; projection must be achieved through the use of the symbol for its own import rather than for the meaning that may or may not be thrust on to it.

The importance of the Roman imitation of Greek drama is possibly historical, in that through their insistence that the characters remain identifiable and constant, the stock characters of the Commedia d'elle Arte were conceived.

Within the establishment of the Christian Church, drama as a means of artistic persuasion and a form of aesthetic delight was reinforced through negative statement. All drama was railed against as being contrary to the teachings of Christ.

For the show always leads to spiritual agitation. For where there is pleasure, there is keenness of feeling, giving pleasure its zest; and where there is keenness of feeling there is rivalry giving in turn its zest to that. Then too where you have rivalry you have rage, and bitterness, and wrath and grief, and all bad things which flow from them - the whole entirely out of keeping with the teachings of Christ. 11

- 
10. Byron, Letter (Jan. 1921) quoted by George Steiner in The Death of Tragedy, p.203.
  11. Tertullian, On the Spectacles, translated by Rev. S. Thelwell, Dramatic Theory and Criticism, pp.9-10.



Mediaeval drama did survive : not only as remembered archetypal characters, inherited from Rome and sung about in the ballads of the minstrel players, but also in the sheer vitality of the performance. Eric Bentley has said :

Now among all those who know that the Commedia dell'arte was for some centuries the main carrier of the tradition of fixed characters, how many realise that it was also the carrier of the tradition of comic brio, verve and diablerie ? 12

If the archetypal characters were all that was carried through on to the middle ages, it would be unlikely that their appearance would necessitate the re-emergence of drama. The vital and immediate presentation of action was, after all, the main feature of commedia dell'arte. In the middle ages this element of action re-emerged in the church and gave rise to the miracle and morality plays. The biblical stories were not in themselves drama until they were presented as a creation in the 'now'. The characters and the plots may have been well known by the audiences but the illusion which, because of its power to involve the imagination, was always fascinating and which the church fought with dire threats of damnation.

Robert Mannyng of Brunne (1288 - 1338) in his Handling Synne allows for the performance of the story of the Virgin Birth and the Resurrection of Christ in the Church, but :

If thou do it in the ways of groves,  
A sight of sin truely it seems. 13

---

12. Eric Bentley, The Life of the Drama, p. 52.

13. Robert Mannyng of Brunne, Handling Synne, Selection from Dramatic Theory and Criticism, p.101.

The power of the performed play was obviously felt. This attraction was probably only in part due to man's fascination with the imitation of life, it is more likely to be the power of dramatic presentation of virtual acts unfolding through their own laws of progression. The awareness of this is demonstrated in an anonymous sermon against Miracle plays written in the late 14th Century. In this sermon there is a clear indication that the miracle plays had the power to evoke through their mode of dramatic presentation a strong emotional response.

... such miracle playing giveth no one occasion of very weeping and needful, but the weeping that falleth to men and women by the sight of such miracle playing, as they do not principally for their own sins nor of their good-faith within sorrow, but more of their sight without. 14

Their 'weeping' then was not due to an introspective view of their sins but rather because of the play itself. This points to the most elemental factor in the theatre, that of empathy. The projected symbolic act on the stage has the ability of arousing an empathetic response in the audience. In tragedy this empathetic response follows the revelation of destiny but every projected act of artistic movement on the stage, be it audible or visible or both, has this power.

In France, between 1600 and 1850, the passion for legislation found itself manifest in such theorists as Voltaire and in The Opinions of the French Academy. The playwright as Idea was born, and for the most part, besides the empathetic power of language, lacked any true theatrical elements. Drama was greatly influenced by the ancients and in particular by the rediscovery of Aristotle's Poetics; the first Latin translation was published by Alessandro Pazzi in 1536. The unities of action,

---

14. Anonymous, Sermon against Miracle Plays, in Dramatic Theory and Criticism, p.101.

time and place were hotly debated and were finally formulated by Lodovico Castelvetro in his treatise on Aristotle's Poetics. The written play should be created, he argues, under strict rules of poetry which for the most part were to be based on the ideas of the ancients.

In a critique written in 1638 on The Cid and which is a reply to the Observer, it is clear that the criteria for a good play are those of construction of plot according to the unities. If a play did not follow the rules, then it is judged to be bad. For example :

The objection that the Observer next raises strikes us as a most serious one, for a primary precept of poetic mimesis is not to make use of more material than one can properly develop but to allow the necessary space to the action that one is imitating. Most certainly, the author cannot deny that it is an artistic failure to have compressed so many unusual incidents into a twenty-four hour period and to have found no other way of filling out his five acts than piling event on event in a short space of time ... . The question here is not one of assembling so many great and varied adventures within so small a space of time, but of implanting in the same mind, and in fewer than twenty-four hours, two ideas as much opposed to each other as retribution for a father's death and the betrothal to his murderer, and reconciling within the same day two acts that could not be suffered in a whole lifetime. 15

Aristotle's Poetics are so pushed along one line of concern for structure, imposed from without, that the play in the hands of minor writers became dominated by a marvellously mechanical construction of plot. The plot, however, was saved from the 'well made play' by writers such as Corneille, Racine and Moliere. Corneille in his third discourse On the Three Unities of Action, of Time and Place, concludes that the success of a play does not depend on satisfying "the extreme rigor of the rule",<sup>16</sup> and proposes that, if the theorists were to be

---

15. The French Academy, The Opinions of the French Academy, mainly the work of Jean Chapelain, Dramatic Theory and Criticism, p.220.

actively involved in presenting plays to the public, they would realise from experience that the rules of unity banish many beautiful things from the theatre. The Neo-classical drama did not allow the actor much scope for gesture or dramatic outcries. All the violence and passion of the piece was contained in the verse. There was no breadth of form as Shakespeare used, no pageantry or music, and for this reason the language of a playwright, such as Racine, in his Phedre, compensates by being powerfully economic, using images in counterpoint much like that of a cantata.

In England the tolerance for diversions from the three unities was much more flexible than it was in France. Although the influence of the Poetics was strong, it was the influence of Seneca that allowed for the treatment of such subjects as madness, mutilation and murder and which allowed Shakespeare to include in his plays, witches and ghosts, murderers and lunatics. The influence of Seneca and that of Plautus in the introduction of comic scenes into tragedy is spoken of by Polonius in Hamlet (Act II, Scene ii) :

The best actors in the world, either for tragedy, comedy, history, pastoral, pastoral-comical, historical-pastoral, tragical-historical, tragical-historical-pastoral, scene individable or poem unlimited: Seneca cannot be too heavy nor Plautus too light. 17

This quotation also shows to what extent the theorist had busied himself in formulating and categorising the type of play. Shakespeare's comment on this is implicit not only in the lines but also in the character who speaks them.

---

17. Shakespeare, Hamlet Act II, Scene ii, LL 424 to 429.

During this period the organic performance of the play was kept alive by the popular Commedia dell'arte, with its emphasis on improvisation. With the establishment of permanent acting companies and theatres these former wandering players were absorbed into the established theatre and were able to influence the playwright.

This may be seen in the Shakespearean form of drama, which encompasses an ever-enlarging view of life:

He used dramatic forms with marvellous pragmatism, shaping them as the need arose. The real and the fantastic, the tragic and the comic, the noble and the vile, were equally present in his apprehension of life. 18

The Elizabethan drama was strongly related to the structure of the society. It was centred around the crown with radial circles of hierarchy moving outwards. Nature was also seen to follow the same hierarchical structures. This vision of social, political and natural life gave Elizabethan drama a unity. The divisions between the tiered balconies and the pit of the playhouse were reflected on the stage in the divisions between the kings and the Calibans; each essential to the other and yet separated, not only in terms of their station, but also in their language; the kings spoke the language of verse which with its pattern of formal recurrence was able to give a sense of special occasion importance and universality, whilst the common man spoke through prose, with its temporality in cause and effect. The unity of Shakespeare's plays lies partially in this Elizabethan concept of the natural order of peoples and events. Shakespeare's freedom from the unities, an outer imposed form which was only mentally conceived and therefore limiting to the natural development of plot and character, enabled him to write

---

18. Eric Bentley, The Life of the Drama, p.

in such a way that was, at once, both more believable and persuasive than the Neo-classicists, whose cry was that any infringement of the unities would jeopardise the credibility of the action, and would demand from the audience impossible stretches of the imagination. Shakespeare had no qualms in inviting his audience to :

And let us, ciphers to this great account,  
On your imaginary forces work. 19

The Elizabethan drama, unconfined by the unities, developed another area of presentation, namely the fantastic or dream world. Illusion and reality became a common theme. Firstly, the illusion of the play was directly presented, during the course of the play, to the audience. The play within the play, masterly wielded into the total import of the play in Shakespeare's Hamlet, gives the audience an opportunity to examine their own relationship to the play. They are able to relate directly to those characters who are watching the play within the play, and through their asides to reassess, examine and define, the relation of illusion to reality and actors to audience. Secondly, the concept of the 'act' was widely used, especially by Shakespeare. The 'act' was used not only to divide the play into its component parts but also in the actual dialogue.

W.J. Lawrence has said of Shakespeare's use of the word 'act' that it carries a double meaning :

It is to be noted that Shakespeare most frequently uses the word 'act' in the sense of deed or action, and yet rarely if ever, without giving it some associated colouring. As a rule the passage in which it occurs smells of the tiring house. Not that there is any deliberate punning on the word: the effect is much more delicately conveyed : it is one of subtle overtones. The meaning is struck out clear on the anvil, but there are reverberations which suggest the playhouse connotation. 20

---

19. Shakespeare, King Henry V, Chorus to Act One, L 17 and 18.

20. W.J. Lawrence. Speeding up Shakespeare p. 4

The idea of an 'act' meaning an action or deed operates, not only in the sense of some physical action undertaken, but also in terms of the other act concepts, namely emotional and mental ones. It may also imply those acts which are the bases of the artistically performed play. Anne Richter points out that the meaning of the word 'act' results :

not so much from the specific nature and quality of the episode they describe as from the fact that a recognition of certain resemblances between the world and the stage is inherent in the English language. One incorporated in the imaginary world of the play, however, they do fulfil two purposes. They remind the audience of the playlike nature of its own life, and they lend an ominous, portentous quality to the action on the stage. 21

It was in this respect that the stage held a mirror up to the nature, not in its individual peculiarities, but in the reflection of the acts that seep through the individual's life-matrix in his dialogue with his real and illusionary world as well as between himself and his social political environment.

The Romantic movement in drama in the 19th Century has been called anti-tragic, although essentially dramatic.<sup>22</sup> The Romantic vision is one in which 'the finality of evil'<sup>23</sup> is not believed in. Steiner writes :

Near tragedy ... represents the desire of the romantics to enjoy the privileges of grandeur and intense feeling associated with tragic drama without paying the full price. This price is the recognition of the fact that there are in the world mysteries of injustice, disasters in excess of guilt, and realities which do constant violence to our moral expectations. The mechanism of timely remorse or redemption through love -- the arch Wagnerian theme -- allows the romantic hero to partake of the excitement of evil without bearing the real cost. 24

- 
21. Anne Richter, Shakespeare and the Idea of the Play, p.83.
  22. George Steiner, Discussed in Death of Tragedy, Chapter IV, p.133.
  23. George Steiner, Discussed in Death of Tragedy, Chapter IV, p.133.
  24. George Steiner, Discussed in Death of Tragedy, Chapter IV, p.133.

Romantic drama was dramatic in that it discarded the confines and rigidity of the French Neo-classics. Gotthold Lessing in the Hamburgische Dramaturgie (1767-1769) argues that it is not sufficient that a playwright should observe the unity of time at the expense of moral unity. The lack of moral unity is immediately noticed by everyone whilst the impossibilities presented through not observing the unity of time, remain unnoticed by many.

The poet therefore who does not know how to preserve physical unity of time except at the expense of moral unity, who does not hesitate to sacrifice the one to the other, consults his own interests badly and sacrifices the essential to the accidental... . 25

In this way the drama was able to be built according to the necessities of character and subject matter. Schiller wrote: 'The final aim to which all the laws tend is called the end of any style of poetry. The means by which it attains this are its form. The end and form are therefore closely related.'<sup>26</sup> The structure of the play was therefore conceived of in terms of the import that the play was to have on the audience, since, as Schiller points out, the end of tragedy is to awaken sympathy. But it is precisely in the romantic notion of sympathy that the play often loses its tragic nature. It has already been stated that the import of tragic drama is the illusion of destiny or fate, all the acts within the play move towards the revelation of a future in the present. Generally, in Romantic drama, the purpose of the play is confused with its mode of communication, namely the empathetic response. Each act, therefore, rather than being directed towards the progression of the play, is rediverted towards the audience supplying them rather than the characters, with tears and laughter and thus producing sentiment in place of art.

---

25. B. Lessing, Hamburgische Dramaturgie, translated by Helen Zimmern in Dramatic Theory and Criticism, p.432.

26. Friedrich Schiller, On the Tragic Art, translator anonymous, Dramatic Theory and Criticism, p.457.



With the rise of the middle-class in the eighteenth century, first the novel, and later, the drama shifted its gaze from the public lives of the kings to the more private and inner lives of the individual. In this sense they were the forerunners of Ibsen and Chekov. With this change in subject matter there was also a change from dramatic verse to that of prose. Perhaps the greatest example of prose drama of this period is Goethe's Faust.

The modern dramatic form begins with Ibsen. Unlike the Greeks and the Elizabethans who had a background of mythical beliefs, Ibsen wrote at a time when an organic view of the world was lacking; he created a new mythology through which destiny could strike. The forces that are at work in his latter plays are not the witches that haunt Macbeth or Hamlet's Ghost, but the ghosts of consciousness and the witches of idealism, broken loose from the realities of the individual in a social world. He articulated this new mythology through the use of symbols that are both realities in the natural world (the sea, the fjord, the church) as well as embodiments of a vision of life.

Kierkegaard, in making a comparison between modern drama and that of the Greeks, criticises modern drama for its concentration on subjectivity.

The tragic hero is subjectively reflected in himself, and this reflection has not only reflected him out of every immediate relationship to state, race, and destiny, but has often even reflected him out of his own preceding life. We are interested in a certain definite movement of his life, considered as his own deed. Because of this tragedy can be exhaustively represented in situation and dialogue, since nothing of the more immediate is left behind. Hence, modern tragedy has no epic foreground, no epic heritage. The hero stands entirely on his own acts. 27

---

27. S. Kierkegaard, The Ancient Tragical Motive as Reflected in the Modern, translated by David Swenson & Lillian Swenson, in Dramatic Theory and Criticism, p.553.

It is certainly true that the future which is intuited in the present action is not that of a universal inevitability but that of the individual's understanding of himself. The mood is predominantly introspective. In the movement known as Naturalism there was an overwhelming preoccupation with its own times. The language, subject matter and techniques of presentation in plays such as Ibsen's Ghost, was taken as a startling perfection of the naturalistic drama. For tragic drama to work there must be conflict. In classical drama this conflict was between man and the cosmos whilst in modern drama the conflict remains within the individual. Thus subjective-objective dualism became a common theme, and Kierkegaard's criticism, stated above, is true in this sense. A criticism that is based on a comparison between the classical and the natural mode of writing and which advocates grief as a more noble passion than the sorrow of modern drama, misses the isomorphic similarities of logical form between the symbol and the thing which it symbolises. The Chekovian drama is a good example of the similarity of inner and outer form. Chekov's innate musicality, with its subdued tones, its gentle movement and poignant stillness, and the almost imperceptible changes of mood, has the same logical progress in its outer perceptible rhythms as the more elusive inner lives of the characters that it represents.

The acts that characterise the drama of Ibsen and Chekov biassociate two worlds, one an inner space of psychological and social tremblings and the other the drawing room of the middle class society. Since the beginning of the twentieth century the debacle of two world wars in which social structures have collapsed and not yet reformed, in which the sciences have invaded the psyche without creating a new coherent mythology, have left an unstable view of the world which is extremely diverse. This diversity is

reflected in drama. Twentieth century drama moves from the reformatory didacticism of Shaw through the theatre of Brecht whose object of inquiry was not just to rouse moral objections ...' but to discover means for their elimination'<sup>28</sup>, to the absurdists and beyond which is predominantly a depiction of man's search for regeneration and psychic unity.

In all styles of drama, it is necessary for the producer to be aware of the historical and social environment of the play that he is to produce. His creative endeavour should not be limited by historical reproduction but focus on a truly creative concept and direction of the play. In order to do this it is necessary that he should biassociate the historical situation of the play with its present value. To produce merely an accurate historical reproduction of any play or to mutilate its content merely for a modern appeal may be an act of virtuosity but lacks creative endeavour. An act of creativity for the director has to rise as a result of a projection from his mind. The fact that he should remain true to the playwright's intention does not prevent him from having a creative concept. Form and content should be interwoven with a total concept that may be realised in terms of a projection embodied in virtual acts of movement, speech and theatrical design.

The director, then, has first to discover the root idea in the script and then to create the root action in terms of virtual acts of movement and speech on the stage. These acts should isomorphically reflect the logical progression of the form in the script.

---

28. B. Brecht, Theatre for Pleasure or Theatre for Instruction, in Dramatic Theory and Criticism, p. 854.

CHAPTER 10

In conclusion it is necessary to re-state the basic concepts developed in this thesis.

Creativity is seen as a process. In all living things there is a substrata of movement from which acts of rhythmic organisation emerge. The beginning of any act is the initial impulse which is not seen as an initial cause but which is already part of the act itself. Thus the relationship of impulse to act is not that of cause and effect but rather a principle of organisation. The organisational principle is dependent on two major factors which in turn give rise to others. These two factors are those of inhibition and induction. Inhibition and induction are movement principles rather than properties of any agent. Agents do not exist initially with movement following, but rather the reverse. In terms of creativity therefore, there are no causative factors which may be directly related to the process. It has been noted that the initial impulse has a natural tendency towards self-completion. On the biological level this tendency is expressed in terms of maturation of the individual and the evolution of species. Individuation is, in fact, a process of development, which in man has emerged as that of mind. The relationships that exist between mind, feeling and physical processes do not arise through separate differentiation but through individuation which is the progressive and evolutionary process of movement. It is therefore possible to state that all movement processes have a natural tendency towards progressive development. The basic unit of any movement phrase is the 'act' which is characterised by an initial impulse, a development, a climax and a fading away of definition back into the general flux of

movement. Because of the developmental process each act has the tendency to entrain other acts or inhibit those that threaten the organisational development of the stronger act. If an act is entrained, it may lose its individuation and become absorbed into the initial act, thereby changing and increasing the complexity of its rhythm. It is possible that acts are entrained and yet maintain their individuality. This is the relationship that exists between feeling and mind. Feeling as a total act concept may be differentiated from mind as a total act concept but the mechanism of the mind may not be divorced from that of feeling. Feeling acts may be completed in movement of the body or be phased to the level of conceptual thought. Because of the extreme complexity of feeling acts, with their biological and neuromuscular sub-acts, there is no either/or selection process between feeling being completed through physical acts of movement or through mental acts. Rather any act of feeling is able to entrain both physical acts as well as mental acts simultaneously. In order to arrive at a concept of the relationship between bodily acts, feeling acts and mental acts, it is necessary to quote Langer at some length :

Unlike many other aspects of vital processes, which are propagated outward with the processes themselves beyond the organism as effects on its surroundings, the phase of being felt is strictly intraorganic, wherever any activities of life attain it. It is an appearance which organic functions have only for the organism in which they occur, if they have it at all. Millions of processes - the whole dynamic rounds of metabolism, digestion, circulation and endocrine action - are normally not felt. One may say that some activities, especially nervous ones, above a certain (probably fluctuating) limen of intensity, enter into 'psychical phase'. This is the phase of being felt. It may develop suddenly, with great distinctness of quality, location and value - character, for instance, in response to a painful stimulus; or similarly, only with less precise location in the organism, like a shock of terror; or a deeply engendered process may go gradually, perhaps barely, into a psychical phase of vague awareness - come and gone - a sense of weariness or a fleeting emotive moment. The normal substrate of 'feeling-tone', from which the more acute tensions build up into specific experiences, is probably a dynamic pattern of nervous activities playing freely across the limen of sentience. 1

---

1. S.K. Langer, Mind: An Essay on Human Feeling, Vol. I, pp.21 and 22.

There is therefore, no fixed level at which neuromuscular and the host of biological acts become phased to that of psychic acts or psychic acts to mental ones. The emphasising of acts in their progressive development towards mental cognition is a fluid one, which is probably dependent on the total tone of the individual as a whole. The individual therefore, may be described as being relative to the acts, sub-acts, and sub-sub-acts which move within his total organism and each act is relative to the total tone of the individual.

All movement acts develop towards individuation and inclusion. For example on the biological level, the heart has its own form of self-government, which is controlled by the pace-maker, this in turn is controlled by the autonomous nervous system and by hormones. Individuation and inclusion may be demonstrated from the genetic point of view where individuation, controlled by genetic expression, is relative to the inclusion of the organism within a larger hierarchical framework as a functioning unit. In terms of bodily movement the tendencies towards lability and stability (stability creating detail and definition in the movement and lability creating continuousness and immersion into the general flow of movement) are the basic considerations in the art of the choreographer.

This concept of mind includes moments in which individuation and inclusion are operative. Mental processes, with the aid of the senses (for example, the ability of the retina to aid in definition between object and surround) are able to define and isolate experiences thereby creating fixed concepts, facts and discursive language. They may also create relationships between objects and ideas through symbolic expression, thereby creating the artistic mode.

The process of symbolic projection is a synthesis of individuation and inclusion. The symbol-making process is both a focusing of personal experience as well as a rooting of those experiences in the larger hierarchical framework of man in his dialectic relationship with his total environment. It is only through the process of symbolisation that man is able to transcend the limitations of his momentary existence and conceive of his life as a unity. This unity of perception moves outward and embraces his total life matrix, which is projected in terms of mythology, social norms, values and works of art. Artistic symbolic projection is the ability of the human individual, through the developing feeling/mind processes to define and biassociate two or more apparently separate matrices of experience into a composite organic wholeness. This organic wholeness is dependent, for its artistic quality on the relationship of the part to the whole and the whole to the part and in the case of dance and drama, on the relationship of virtual acts to the completed symbolic work and vice versa.

The act is a basic unit in the organic biological life as well as in the process of projecting symbols in the form of art works. Movement as sheer flux escapes conceptual thought. It is necessary to conceive of it in terms of rhythmic composition. Rhythmic composition may be defined in terms of the spatial and temporal rhythmical configurations of the act. The importance of this lies in the fact, that what is then observed is the progression of movement rather than stillness or fixed points. To observe spatial and temporal rhythms is a process of abstraction and therefore it involves the observer's 'weltanschauungen'. This includes man's unique ability to think and communicate beyond the realm of the present situation. Through speech man's world has been increased beyond the present needs and is able to embrace the past in a symbolic concept, to project

towards the future and imaginatively create virtual symbols that reflect his consciousness of himself and his sociality. The observation of rhythmical spatial and temporal configurations is one of the most fundamental processes in the development of the individual towards maturity. The concepts of space and time are formed in early childhood through an experience and observation of his own body. Later he is able to use these concepts in building up a unified view of himself and a perspective of the world that lies close to reality. Furthermore, through a continuous experience of rooting the conceptual world in the lived experience of movement and especially in the creative process of symbolic projection he is able to become aware of his intellect as a progressively advancing process. Through symbolic projection, which is the basis of communication, man has built up societies which are a reflection of the spatio-temporal world itself. This is achieved in terms of man's modes of feeling, perception, conceptual thought and understanding of communication.

Intraorganic or autogenic experiences and those that are felt as arising from the external world have their unity in the creative process of communication. The human brain is so extremely complex that no one systematising of its function holds without many exceptions. Peripheral feeling maintains a contact with the external realities of the world and those that are autogenic aid man in the awareness of the self. However, any impactive feeling may impinge on the autogenic processes and so modify the concept of the self. Similarly a thought of some past experience may forcibly enter into the peripheral mode of feeling and so change the perspective of reality. It is therefore only through a continuous dialectic of these two modes of feeling that man may progress in his intellectual and moral development.



The choreographer's art is the creation of symbolic acts of bodily movement. The import of his art is the revelation of virtual force. Movement in dance is not merely the progression of the body through space and time but the selection of movement acts that are relevant to the unfolding of eukinetic and choreutic trace forms which in themselves reflect organic life. Dance has its origins in primitive man's attempt to directly experience the force that he perceived in the world. In modern times its appeal is still of this essence, in that, in dance the artist uses 'everything ... that can serve to make the semblance of psychic or mental powers an image of the "powers" directly felt in all organic life, physical or mental, active or passive'.<sup>2</sup> The secondary illusions of dance, pure virtual space and pure virtual time, are not the subject matter of dance they are illusions created by sub-acts within the total form of the dance and which support the illusion of force or 'power'. Feeling emanates from the dance through the composite interrelationship of movement acts. The image that is formed through this interrelationship:

gives evidence of the primary vision conceived through the inner experience. That creation will ever be the most pure and forceful in its effect, in which the most minute detail speaks of the vibrating, animated unity which called forth the idea. The shape of the individual's inner experience ... will also have the unique magnetic power of transmission which makes it possible to draw other persons, the participating spectators, into the magic circle of creation. 3

The choreographer's art is a creation of virtual force through the movement of the dancers which is symbolic of the power that surges through the

---

2. S.K. Langer, Feeling and Form, p.206.

3. Mary Wigman, 'The New German Dance' in Modern Dance, p.23.

organic, emotional and mental life of man. Character, plot and story are secondary considerations. If they are present at all, they are only justifiable if they aid in focusing attention towards the primary illusion of force, that power which is experienced by all men as the initiator and sustainer of life itself.

The director's art is the creation of the illusion of the future in the present. In tragedy this may be defined as the illusion of destiny and in comedy that of the illusion of sheer vitality expressed in terms of the society and exemplified in the individual. His creative process is one in which he brings together his understanding of the script and the embodiment of that concept in the virtual acts presented on the stage by the actor. He is concerned not only with the playwright's intention but also with its mode of expression. In creating virtual acts on the stage he has to create an isomorphic semblance of the logical form of the script and reflect in the relationship and progression of acts, the tone and mood of the drama.

The dynamic process of creativity in the theatre is an expression of man's changing perception of himself and his world in terms of projected symbols. The art of dance and that of drama fulfil two separate, though related functions, in the formulation of the artistic or aesthetic vision. Dance is not drama. They each have their unique mode of expressing their import, and the creation of these modes emerges from man's unique specialisation of function, that is, the ability to consciously project symbols in terms of art.

BIBLIOGRAPHY

- ARISTOPHANES The Frogs. Translated by G. Murray. Allen and Unwin.
- ARGYLE, M. The Psychology of Inter-personal Behaviour, 2nd Edition, England: Penguin. 1972.
- APPOLLONAIRE, G. Document of Twentieth Century Art. Translated by S. Suleimans. London: Thames and Hudson. 1972.
- BUBER, M. Between Man and Man. Great Britain: Fontana 1972.
- BIRDWHISTLE, R.L. Kinesics and Context. London: Allen Lane, The Penguin Press. 1970.
- BROAD, W.R. The Mind and its Place in Nature. 5th Impression. London: Routledge and Kegan Paul, 1968.
- BEADLE, C.W. Genes and Biological Enigmas, Science Journal Paladin. 1972.
- BURRET, MACFARLENE Genes, Dreams and Realities. Great Britain: Pelican Books. 1972.
- BRAIN, W.R. Speech and Handedness, Lancet II, in Brain LxxIII 1945.
- BERLYNE, D.E. Structure and Direction in Thinking, 2nd Edition. New York: John Wiley & Sons Inc. 1966.
- BEECH, H.R. Changing Man's Behaviour. London: Penguin Books. 1971.
- BEISWANGER, G., HOFMAN, W.A. and LEVIN, D.M. Three Essays in Dance Aesthetics in Dance Perspectives Foundation. New York. 1973.
- BENDALL, Muscles, Molecules and Movement, London: Heinemann Educational Books, Ltd. 1969.
- BARRAULT, Jean-Louis Reflections on the Theatre. London: Rockliff Publishing Co. 1951.
- BENTLEY, E. The Life of the Drama. London: Methuen & Co. Ltd. 1966.
- BENESH, R. & J. An Introduction to Benesh Movement Notation. London: Dance Horizons. 1958
- CALDER, R. Man and the Cosmos. England: Penguin Hammondsworth. 1970.
- CAMPBELL, K. Body and Mind. London: MacMillan Press. 1971.
- CARR, D. The Crises of European Sciences and Transcendental Phenomenology, Eunston, U.S.A.: Northwestern University 1970

- CHOMSKY, N. Problems of Knowledge and Freedom. England: Fontana, 1970.
- CLARK, Barret H. European Theories of the Drama. New York: Crown Publishers, Inc. 1972.
- CLOWES, R. The Structure of Life. England: Pelican Press. 1970.
- CRYSTAL, D. Linguistics. London: Penguin. 1971.
- COHEN, S. Drugs of Hallucination. Great Britain: Palidin. 1971.
- COPI, I. Introduction to Logic. 4th Edition. New York: MacMillan Co. 1972.
- CASSIRER, E. An Essay on Man. New Haven and London: Yale University Press. 1962.
- COLE, T. and CHINYOY, H.K. Directors on Directing. London: Peter Owen Ltd. 1970.
- DARWIN, C. The Origin of the Species, Edited by G. Burrow. London: Pelican Classics. 1968.
- DE HAAN, R.L. Emergence of Form and Function in the Embryonic Heart. Science Journal, Paladin. 1972.
- DODD, Nigel & HICKISON, Winifred Drama and Theatre in Education. London, Heineman . 1971.
- DE CHARDIN, Pierre Teilhard The Phenomenon of Man. Great Britain : Collins-Fontana Books. 1971.
- DUKORE, B.F. Dramatic Theory and Criticism. New York: Holt, Rinehart & Winston, Inc. 1974.
- DE BEAUVOIR, S. The Ethics of Ambiguity, Reprint. New Jersey: The Citadel Press. 1972.
- EDDINGTON, Sir, A. The World of Mathematics. London: MacMillan Press.
- EHRENZWEIG, A. The Hidden Order of Art. London: Paladin. 1967.
- EBERT, & SUSSEX, Interacting Systems in Development, Modern Biology Series. 1965.
- FINDLAY, I.N. Phenomenology in America. New York.
- FRANKL, V.E. The Doctor and the Soul. England: Penguin. 1973.
- FREEMAN, E. The Theatre of Albert Camus. London: Methuen & Co. Ltd. 1971.
- FROMM, E. Marx's Concept of Man. New York: Ungar Publishing Co. 1971.

- FURLONG, E.T. Imagination. New York: George, Allen & Unwin. 1961.
- FURNESS, R.S. Expressionism. London: Methuen & Co. 1973.
- FURT, L.R. & SKRINE, P.N. Naturalism. London: Methuen & Co. 1971.
- GASKELL, R. Drama and Reality. London: Routledge, Kegan Paul. 1972.
- GRAHAM, M. The Notebooks of Martha Graham. New York: Harcourt Brace Jovanovitch Inc. 1974.
- GREENE, J. Psycho-Linguistics, Chomsky & Psychology. Great Britain: Penguin. 1974.
- GREGORY, R.L. Eye and Brain, 2nd Edition. London: World University Library. 1972.
- GORDON, W.J.G. Synetics. New York: Harper and Row. 1971.
- GALLAWAY, M. The Director in the Theatre. New York: MacMillan Co. 1963.
- GIBSON, Muse and Thinker. England: Penguin Books. 1972.
- HAGEMANN, F.R. Some Aspects of Eukinetics and Choreutics in Drama. M.A. Thesis, Natal University, Durban. 1973.
- H'DOUBLER, M.N. 'Dance: A Creative Art Experience'. Wisconsin, U.S.A.: University of Wisconsin Press. 1940.
- HINDE, R.A. Non-Verbal Communication. England: Cambridge University Press. 1972.
- HORST, Louis & RUSSEL, Carol Dance Forms in Relation to the Other Arts. New York: Dance Horizons. 1963.
- HUDSON, R.A. Frames of Mind. Great Britain: Pelican Books. 1970.
- HUNTER, I.M.L. Memory. Revised Edition. London: Pelican. 1964.
- HYDEN, H. Biochemical Aspects of Brain Activity in Memory Mechanisms. Pelical. 1969.
- \_\_\_\_\_ The Cell, Edited by A.E. Mirsky. New York: Academic Press. 1972.
- HODGE, F. Play Directing. New Jersey: Prentice-Hall. 1971.
- JONES, J. On Aristotle and Greek Tragedy. London: Chatto and Windus, Ltd. 1962.
- KANT, I. Immanuel Kant's Critique of Pure Reason, Second Edition Reprint. Translated by N. Kemp Smith. London: MacMillan & Co. Ltd. 1970.

- KATZ, B. Nerve, Muscles and Synapses. England: McGraw Hill Book Co. 1966.
- KAUFMANN, W. Existentialism from Dostoevsky to Sartre. New York: Meridan Book, World Publishing Co. 1972.
- \_\_\_\_\_ Tragedy and Philosophy. New York. Anchor Books Double Day & Co. Inc. 1969
- KIRSTEIN, L. Three Pamphlets Collected. New York: Dance Horizons Inc. 1967.
- KORZYBSKI, Science and Sanity. New York: International Non-Aristotelian Library. 1958.
- KOSTELANETZ, R. John Cage. London: Allen Laine, Penguin Press. 1971.
- KRAUS, R. History of the Dance. New Jersey: Prentice-Hall Inc. 1969.
- KERNAN, A.B. The Modern American Theatre. New Jersey: Prentice-Hall Inc. 1967.
- KOESTLER, A. The Act of Creation. London: Pan Books Ltd. 1970.
- KRAILSHEIMER, A. (Editor) The Continental Renaissance. England: Penguin Books Ltd. 1971.
- LABAN, R. & LAWRENCE, Effort. London: MacDonal and Evans. 1947.
- LABAN, R. Mastery of Movement. London: Macdonald and Evans. 1960.
- \_\_\_\_\_ Choreutics. London: Macdonald and Evans. 1969
- \_\_\_\_\_ Principles of Dance and Movement Notation. London: MacDonal and Evans. 1956.
- LANGER, S. Problems of Art. London: Routlegde and Kegan Paul. 1957.
- \_\_\_\_\_ Feeling and Form. London: Routledge and Kegan Paul. 1953.
- \_\_\_\_\_ Philosophy in a New Key. New York: Harvard University Press. 1951.
- \_\_\_\_\_ Mind: An Essay on Human Feeling, Volumes I and II. Baltimore and London: The John Hopkins University Press. 1972.
- LAYER, J. and HUTCHINSON, S. (Editors) Communication in Face to Face Interaction. Great Britain: Penguin Books. 1972.
- LAWSON, J. A History of Ballet and Its Makers. London: Dance Books. 1973.

- LURIA, A.R. and LA YUDOVICH, F. Speech and the Development of Mental Processes in the Child. London: Penguin Books. 1971.
- LLOYD, J. The Borzoi Book of Modern Dance. New York: Dance Horizons Inc. 1949.
- LOCKE, M. The Emergence of Order in Developing Systems. New York: New York Academic Press. 1968.
- LYONS, J. Chomsky. Great-Britain: Fontana Collins. 1970.
- LA BARRE, The Ghost Dance. London: Allen and Unwin. 1972.
- LEACH, E. Levi-Strauss. Great Britain: Wm. Collins & Co. Ltd. 1973.
- LAWRENCE, Speeding Up Shakespeare. London. 1937.
- MACKAY, D. The Human Brain, in Science Journal. Paladin. 1972.
- MacQUARRIE, J. An Existential Theology. Great Britain: Penguin Books. 1973.
- MCDONAGH, D. The Rise and Fall and Rise of Modern Dance. New York: The New American Library Inc. 1971.
- MacMURRAY, J. Reason and Emotion. Re-Issue. London: Faber and Faber Ltd. 1972.
- MEDNICK, S.A. Learning. New Jersey: Prentice-Hall. 1964.
- MILLER, P.R. Sense and Symbol. London: Staples Press. 1969.
- MONTAGNA, W. The Structure and Function of Skin. New York: Academic Press. 1962.
- McNEILL, D. The Acquisition of Language. New York: Harper and Row. 1970.
- MacGOWAN, K. and MALNITZ, W. Golden Ages of the Theatre. New Jersey: Prentice-Hall Inc. 1959.
- MASLOW, A. The Farther Reaches of Human Nature. London: Penguin Books. 1971.
- METHANY, E. Movement and Meaning. New York: McGraw-Hill Book Co. 1968.
- NATHAN, P. The Nervous System. Re-Print. England: Penguin Books. 1973.
- NIETZCHE, F. On the Genealogy of Morals, Translated by W. Kaufmann and R.J. Hollingdale, Vintage Books. 1969.
- \_\_\_\_\_ Twilight of the Idols : The Anti Christ. England: Penguin Classics. 1972.

- NORTH, M. Personality Assessment through Movement. London: MacDonal and Evans. 1972.
- OESTERLEY, W.O.E. The Sacred Dance. New York: Dance Horizons. 1973.
- OLDS, J. Emotional Centres in the Brain, from The Science Journal. Paladin. 1972.
- PERCIVAL, J. Experimental Dance. London: Studio Vista. 1971.
- PIAGET, J. The Child's Concept of Movement and Speed. Translated by G.E.T. Holloway and M.J. Mackenzie. New York: Ballantine Books. 1970.
- POOLE, R. Towards Deep Subjectivity, 2nd Impression. London: Penguin. 1973.
- PRIBRAM, K.H. Some Dimensions of Remembering : Steps towards a Neuropsychological Model. New Jersey: Prentice-Hall Inc. 1971.
- RACINE, Phaedre. Heinemann.
- RAMSDEN, P. Top Team Planning. London: Associated Business Programmes Ltd. 1973.
- READ, H. The Meaning of Art. London: Faber and Faber 1972.
- \_\_\_\_\_ The Philosophy of Modern Art. London: Faber and Faber. 1969.
- REDFERN, H.B. Concepts of Modern Educational Dance. England: Henry Kimpton Publishers. 1973.
- REICH, W. Listen, Little Man. London: Souvenir Press (Educational) and Academic Ltd. 1972.
- RICHTER, A. Shakespeare and the Idea of the Play. England: Penguin Books. 1967.
- ROBERTSON, A. The Input Message. Science Journal, in The Human Brain. Paladin. 1972.
- ROOSE-EVANS, J. Experimental Theatre. New York City: Universe Books. 1973.
- SACHS, C. Rhythm and Tempo. New York. W.W. Norton & Co. 1953.
- World History of the Dance. New York: W.W. Norton & Co. 1963.



- SHAKESPEARE, W. Henry V. London: Oxford University Press. 1961.  
Hamlet. London: Oxford University Press.
- 
- SHANK, T. The Art of Dramatic Art. A Delta Book, New York: Dell Publishing Co. Inc. 1972.
- SHOUKSMITH, Intelligence, Creativity and Cognitive Style. London: B.T. Batford. 1970.
- SKINNER, B.F. Beyond Freedom and Dignity. London: Penguin Books. 1971.
- STEBBINS, G. Delsart's System of Expression. London: Edgar S. Werner Publishing Co. 1902.
- STEINER, G. The Death of Tragedy. London: Faber and Faber. 1958.
- STOKES, A. The Image in Form. London: The Image in Form. 1972.
- SWEENEY, R.T. (Editor) Selected Readings in Movement Education. Massachusetts. 1970.
- SWENSON, D.E. & LOWRIE, T.W. Concluding Unscientific Postscript. Princeton University Press. 1941.
- TODD, M. The Thinking Body. New York: Dance Horizons. 1959.
- VAN TUYL, Anthology of Impulse. New York: Dance Horizons Inc. 1969.
- VERNON, P.E. (Editor) Creativity. Great Britain: Penguin. 1970.
- WARNOCK, G.J. Contemporary Moral Philosophy. Reprint. London: MacMillan & Co. Ltd. 1970.
- WHEELER, H. Beyond the Punitive Society. London: Wilwood House. 1973.
- WIGMAN, M. The New German Dance in Modern Dance, New York. 1948.
- WILLIAMS, M. Brain Damage and the Mind. Great Britain: Penguin. 1973.
- WILLIAMS, R. Drama in Performance. London: Penguin Books. 1972.
- WOLLHEIM, R. Art and its Objects. Great Britain: Pelican Books. 1970.