

**Studies on some Pharmacological Properties of
Capsicum frutescens-derived capsaicin in
Experimental animal Models**

DECLARATION

I, Adebayo Taiwo Ezekiel Jolayemi (Reg. No 9903902), hereby declare that the thesis/dissertation entitled:

**“Studies on some Pharmacological Properties of
Capsicum frutescens-derived capsaicin in
Experimental animal Models”**

is an original work, and has not been presented in any form, for any deg to another university. Where the use was made of the works of others, it has been duly acknowledged and referenced in the text. This research was carried out in the Durban-Westville campus of the University of KwaZulu Natal using the laboratory services of Departments of Physiology, Pharmacology and the Biomedical Resource Centre.

Adebayoezekiel taiwojolayemi
Signature

03/15/2012.
Date

Abbreviations

ANOVA Analysis of variance.	(Ach) Acetylcholine.
(ACEI) Angiotensin converting-enzyme-inhibitors	
ADT Adenine Tri phosphate	(ATR) atropine
Ca ²⁺ Calcium	COX-2 cyclooxygenase 2 receptor
CaCl ₂ Calcium Chloride	(CPF), capsaicin
(CGRP) calcitonin gene-related peptide	(CNS) central nervous system
(CFA) complete Freund's adjuvant	(CPF) synthetic capsaicin
CFE Capsicum frutescens extract.	
(DCM) dichloromethane	(DIC) diclofenac
(DP/dt) Change in ventricular contraction per unit change in time	(CRP) C - reactive protein
(DRG) dorsal root ganglion	(EAA) excitatory amino acids
(FRAP) flouride-resistant acid phosphatase	G (gm) gram.
(GABA) gamma-aminobutyric acid	(GIT) gastro-intestinal tract
(INR) Internationalised Normalised Ratio	(IBD) irritable bowel syndrome
Kg (Kilogram)	K ⁺ Potassium ion
KCl Potassium Chloride	
LVDP Left Ventricular Diastolic Pressure	MgCl ₂ Magnesium Chloride
(MPN) Morphine	(MRT) mean reaction time (secs)
NaCl Sodium Chloride	NaHCO ₃ Sodium bicarbonate
NaH ₂ PO ₄ Sodium Hypophosphoric Acid	
(NANC) non-adrenergic and non-cholinergic neurotransmitters	
(NGF), nerve growth factor	(NMR) Nuclear Magnetic Resonance
(IBD) irritable bowel syndrome	(NKA) neurokinin A
NK-1R Neurokinin 1R receptors	(NMDA) N-methyl-deamine aspartate
receptors	(NPY), neuropeptide Y
NSAIDs Non steroidal anti-inflammatory drugs	
(NO) nitric oxide	
(PAG) periaqueductal system	(PAG) periaqueductal system
(PAN) primary afferent nerves	(PT), protrombin time
(aPTT) activated partial prothromboplastin time	
(SP) Substance P	(SEM) Standard error of mean
TLC Thin Layer Chromatography	(TRPV1) Transient-Receptor-Potential V1
(TTC), 1% triphenyltetrazolium chloride	UV light Ultra violet light
(VR1) vanilloid receptor)	(VIP), vasoactive intestinal polypeptide

ACKNOWLEDGEMENT

I am eternally grateful to many people who have contributed in no intangible way to the success of this project. To all, a collective thank you.

- To Professor John A O Ojewole, my supervisor, for stimulating my interest in ethnopharmacology, chromatography, and pharmacodynamic studies. Words cannot express the amount of effort that he put in this project by way of guidance, constructive criticisms and correction of the manuscript . The systematic approach to trials was laid down at the onset of the research. Even with scarcity of equipments, we had to rely on Prof Ojewole' personal research equipments. Thanks a lot Prof.
- Professor Musabayane impacted positively in research methodology, guidance in result analysis and supporting the utilization of the Physiology laboratory for experiments. Thanks a lot.
- Other senior staff members of Pharmacology department, Physiology department, Medical Research Council, Biomedical Resource Centre of Westville Campus for all their accommodation and support.
- The Instrument department was very innovative in modeling equipments at every point in time and supplying needed instruments.
- To the members of Physiology department especially the technical staff for all their contribution to the success of the study.
- To the staff of Pharmacology department for accommodation and support.
- To Prof Shode and members of the Organic Chemistry department for all the services towards the successful chromatographic extraction of capsaicin.
- To my late father, Chief Morohunfade Jolayemi for encouraging on possible medicinal uses of ethno-based tubers and plants.
- Finally to my wife, Mary and children, Oluwafunso, Oluwaseye, Oluwatobi and Oluwafunke for all their support during the period of this study.

ABSTRACT

The present study investigated pharmacological properties of *Capsicum frutescens*-derived capsaicin, including its analgesic, anti-inflammatory and coagulatory properties. The effects of capsaicin on gastrointestinal and myocardial muscles, as well as on myocardial ischaemic-reperfusion, were also investigated.

Capsaicin pre-treatment in neonatal rats has been found to abolish the development of thermal hyperalgesia produced in a model of neuropathic pain in rats (Toth-Kasa *et al.*, 1986). In addition, capsaicin sensitivity has been found to be dependent on continued presence of nerve growth factor (NGF), whose concentration increases in inflamed tissues (Bevan and Winter, 1995). By stimulating the release of excitatory amino acids (EAA); such as glutamate and neuropeptides [(CGRP, neurokinin A (NKA) and Substance P (SP)] from both the peripheral and central terminals of sensory neurones by two mechanisms (Kroll *et al.*, 1990; Del Bianco *et al.*, 1991; Lou *et al.*, 1992; 1994; Woolf *et al.*, 1994); capsaicin has been shown to produce a longer-term inhibitory effect. This is one likely mechanism for capsaicin analgesic and anti-inflammatory actions (Bleakman *et al.*, 1990).

Within the gastro-intestinal tract, SP and NKA are involved in the physiological control of several digestive functions, such as motility, fluid and electrolyte secretion, blood flow, and tissue homeostasis (Otsuka, 1993; Holzer *et al.*, 1997). Consistent with this finding, upsurge of SP in irritable bowel syndrome (IBD) was confirmed by Mantyh *et al.*, (1988). Pre-treatment of rats with either capsaicin or NK-1R antagonists dramatically reduced fluid secretion, mucosal permeability, and intestinal inflammation in animal models of acute and chronic inflammation (McCafferty *et al.*, 1994; Pothoulakis *et al.*, 1994).

Capsaicin can modulate endocrine and paracrine activities, immune responses, as well as gastro-intestinal and cardiovascular functions. Moreover, up-regulation of Substance P receptors was found to be associated with chronic inflammatory conditions (De *et al.*, 1990). Stimulation of transient receptor potential vanilloid 1 also results in the activation of nociceptive and neurogenic inflammatory responses (Rigoni *et al.*, 2003).

The pharmacodynamic effects of capsaicin on the cardiovascular system remain elusive. Some actions of capsaicin on the heart were attributed to an interaction at K⁺ channels (Castle, 1992), or liberation of neuropeptides, most notably calcitonin-related-peptide (CGRP) from the vanilloid-sensitive innervation of the heart (Franco-Cereceda et al., 1988; 1991). The possibility of a direct effect of capsaicin on the heart via a cardiac vanilloid receptor (VR), or through interaction of vanilloid receptors with purinergic receptors, and subsequent release of nitric oxide (NO), leading to vasodilatation were considered. Evidence abound in the literature that Ca²⁺ ions are released through 1, 4, 5 inositol phosphatase by the release of phospholipase C, or through interaction of the vanilloid receptors with cannabinoids. In an earlier study, Jaiarj *et al.* (1998) found that capsaicin acting on the heat-sensitive vanilloid receptors, had thrombolytic effects. Though weak evidence, Jaiarj *et al.* (1998) observed that individuals who consume large amounts of *Capsicum* have lower incidence of thromboembolism.

Following ethical approval, the study reported in this thesis was conducted in phases. Identification of *Capsicum frutescens* (facilitated by a botanist in the Department of Botany, Westville campus of the University of KwaZulu Natal). Chromatographic extraction of capsaicin from *Capsicum frutescens* was followed by Nuclear Magnetic Resonance (NMR) analysis of the extract. Animal studies were conducted using capsaicin extract (CFE) and/or a reference capsaicin (CPF), using ‘hot plate’ and ‘acetic acid’ test methods to investigate the role of capsaicin on analgesia. Fresh egg albumin-induced inflammation was used to investigate the role of capsaicin in inflammation, following pre-treatment with CFE and CPF. Concentration-response curves of increasing concentrations of capsaicin, acetylcholine and other agonist drugs with specific antagonists on strips of chick oesophagus, guinea-pig ileum, and rabbit duodenum were constructed following investigations on gastrointestinal (GIT) smooth muscles. The effect of capsaicin on coagulation was assessed by measuring international normalized ratio (INR) of animals that were exposed to different concentrations of capsaicin (CFE and CPF). Furthermore, parallel control studies were conducted in each of these investigations using distilled water or saline as placebo-control or specific-prototype agonists’ negative-control. Cardiovascular investigations included studies on the effects of capsaicin on the heart rate, inotropy,

coronary perfusion pressure, and ischaemic-reperfusion injury, using Langendorff's rat heart models.

Collated data were triangulated by manual hand-written and PowerLab data acquisition, or computerised capture. Statistical analysis were performed by either one or two of the following: Student's t-test, ANOVA (repeated or single-use modes), facilitated and confirmed by Graph Pad Prism, Microsoft Excel or CPSS software(s).

Reproducibility and relevance to the stated objectives of the various studies were confirmed by assessing which of the Null or Alternative hypothesis is validated by the results from the test.

Treatment with CFE or CPF at all doses significantly ($p < 0.01$) increased MRT. By comparison with control, writhing responses to acetic acid were significantly reduced following pre-treatment with various doses of CFE or CPF. The results in both parallel groups of CFE and CPF in the hot plate and acetic acid tests had Pearson correlation of one (1).

Compared to the diclofenac (DIC) group, the degree of inhibition of paw oedema by CFE and CPF was statistically significant ($P < 0.05-0.001$), best in the first 4 hours of treatment.

The results of the *in vitro* laboratory animal study indicate that relatively low concentration of CPF (20 or 40 μg) produced significant ($p < 0.05$), concentration-related inhibitions of acetylcholine (0.1-5 μg)-induced contractions of the chick isolated oesophagus, guinea-pig isolated ileum and rabbit isolated duodenum. Biphasic effects, which were noticed at low concentrations, consisted of initial brief contractions, followed by longer-lasting relaxations and reductions of the contractile amplitudes of the muscle preparations. Percentage inhibitions of the smooth muscle contractions by CFE or CPF were concentration-dependent, ranging from 20-70% ($p < 0.02$).

The difference means of INR between the treatment groups was statistically significant ($P < 0.05$), showing INR of 1 ± 0.1 , 1.4 ± 0.1 and 2.0 ± 0.3 , respectively, for the treatment groups of CFE, 2.5, 5.0, 10 mg/kg, respectively.

The results obtained from cardiac muscle experiments showed biphasic effects with concentration-dependent increases in the heart rate from a capsaicin dose of 0.05 $\mu\text{g/ml}$ up to a dose of 0.3 $\mu\text{g/ml}$ (at $P < 0.001$), and decrease in the mean heart rate of the Wistar rats' hearts from a dose of 0.3- 1 $\mu\text{g/ml}$ (at $P < 0.001$). The slope of the left ventricular diastolic pressures per unit change in time (dp/dt) showed a dose-dependent reduction in the left ventricular contraction when treated with a concentration range of 0.05-1 $\mu\text{g/ml}$ (at $P < 0.001$). Unlike earlier studies, the bulk of the evidence from this study showed that capsaicin extract may not be the best agent to protect the heart against ischaemia-reperfusion injury.

In conclusion, the results of the present study indicate that capsaicin has analgesic, anti-inflammatory, and anti-coagulatory effects. The effects of capsaicin on GIT smooth muscles and cardiac muscles are biphasic, with stimulatory and inhibitory effects, depending on the concentration or dose.

TABLE OF CONTENT

Title

Certification

Abbreviations

Summary

Acknowledgement

List of Tables

List of Figures

Abstract

Chapter One

	Page
Introduction and background information	
1.1 Overview	1
1.2. Research objectives	3
1.3. Hypothesis	3
1.3.1. Null Hypothesis	3
1.3.2. Alternative Hypothesis	3
1.4. Organization of the Study.	4

Chapter Two

LITERATURE REVIEW

2.1 Evolution and revolution of phytochemicals	8
2.1.2. Capsaicin - The natural history and science	9
2.1.3. Chemistry of capsaicin	10
2.1.4. Measurement of pungency and potency of capsaicin	11
2.1.5. Uses of capsaicin	12
2.2 Physiology and pharmacology of capsaicin	12
2.2.1. Pain pathways	12
2.2.2. Pharmacology of pain receptors	13
2.2.3. Supranuclear pain receptors modulation	15
2.2.4. Higher cerebral function in pain	16

2.2.5. Pain-associated Areas in the brain	17
2.2.6. Summary of pain mechanisms	18
2.3. Physiology and pharmacology of Substance P	18
2.4. How and where capsaicin works?	19
2.5. Interaction between capsaicin, Substance P, vanilloid Receptor (TRPV 1) and other receptors	20
2.5.1. Capsaicin receptor	20
2.5.2. Effects pH changes on capsaicin activity	21
2.5.3. Modulator of capsaicin activity	23
2.5.4. Capsaicin and neural desensitization	23
2.5.5. Summary of the mechanisms of the action of capsaicin	26

Chapter Three

STUDY METHODOLOGY

3.1. Research methodology	51
3.2.1. Experimental protocols	51
3.2.2. Plant material and preparation for extract	52
3.2.3. Chromatographic fractionation	52
3.3. Chromatography	59
3.2.1. Basic principles	60
3.4. Other types of chromatography	63
3.4.1. Paper chromatography	63
3.4.2. Gas chromatography	66
3.5.1. Analgesic/neuropharmacological studies	66
3.5.2. Anti-inflammatory studies	67
3.5.3. Extra vascular smooth muscle studies	67
3.5.4. Haematological studies	68
3.5.5. Cardiovascular studies	68
3.6. Data analysis	69
3.7. References	70

Chapter Four

ANALGESIC/NEUROPHARMACOLOGIC EFFECTS OF CAPSAICIN

4.0. Summary	72
4.1. Introduction	73
4.2. Animals	74
4.3. Data Analysis	76
4.4. Results	77
4.5. Discussion	79
4.6. Conclusion	81
4.7. References	82

Chapter Five

ANTI-INFLAMMATORY AND ANTIBACTERIAL EFFECTS OF CAPSAICIN

5.0. Summary	86
5.1. Introduction	86
5.2. Materials and Methods	88
5.4. Results	88
5.5. Discussion	91
5.6. Conclusion	93
5.7. References	94

Chapter Six

EFFECTS OF CAPSAICIN ON GIT SMOOTH MUSCLES

6.1. Summary	99
6.2. Introduction	99
6.3. Materials and Methods	100
6.4. Results	103
6.5. Discussion	109
6.6. Conclusion	110
6.7. References	111

Chapter Seven

HAEMATOLOGICAL EFFECTS OF CAPSAICIN

7.1. Summary	116
7.2. Introduction	116
7.3. Materials and Methods	117
7.4. Results	118
7.5. Discussion	120
7.6. Conclusion	122
7.7. References	123

Chapter Eight

CARDIOVASCULAR EFFECTS OF CAPSAICIN

8.1. Summary	126
8.2. Introduction	126

8.3. Materials and Methods	127
8.4. Results	128
8.5. Discussion	135
8.6. Conclusion	138
8.7. References	140

Chapter Nine

CONCLUSION and RECOMMENDATIONS

9.1. Summary	143
9.2. Analgesic effects of capsaicin	143
9.3. Behavioural effects of capsaicin	143
9.4. Capsaicin and inflammation	144
9.5. Capsaicin and GIT effects	145
9.6. Capsaicin and coagulation	146
9.7. Capsaicin and cardiovascular effects	147
9.8. Side-effects of capsaicin	147
9.9. Drug designing of capsaicin	148
9.10. Conclusion	148
9.11. Recommendations	147
9.12. References	150

APPENDIX

Appendix I. Publications from this study	160
Appendix II. Photographs of Major Equipments used	166
Appendix III Photographs of Dissected Animals	172
Appendix IV. Experimental Set-ups	173
Appendix V. Experimental Data (Tables. A.5.1-6.)	175

LIST OF TABLES

Table 3.1-4. DP 14-16 and 27. Composition of eluates from extraction of capsaicin from <i>Capsicum frutescens</i>	54
Table 5.1. Degree of anti-inflammatory effects of CFE or CPF	89
Table 5.2. Percentage inhibition of swelling by CFE or CPF	91
Table 5.3. C-reactive proteins (CRP) levels	92

LIST OF FIGURES

Figure 2.1. Different species of Capsicum and the finished products as spices (bottled)	9
Figure 2.2. Multi-receptor and multi-synaptic pain mechanisms.	14
Figure 2.3. Multi-receptor concepts of pain pathways	15
Figure 2.4. Spinal mechanisms of pain (central sensitization)	15
Figure 2.5. Healing following axonal injury	16
Figure 2.6. Ascending and descending pathways	17
Figure 2.7. Some mechanisms of capsaicin	22
Figure 3.1. Flow chart for extraction of capsaicinoids from <i>Capsicum frutescens</i>	53
Figure 3.2. Filtration of extracts of <i>Capsicum frutescens</i>	58
Figure 3.3. Gentle heating of residue in ethylacetate or methanol	58
Figure 3.4. Column chromatography identifying 3-4 different capsaicinoids	59
Figure 3.5. Paper chromatography before drying in the oven	63
Figure 3.6. Fume chimney for spraying and flushing	64
Figure 3.7. Paper chromatography following spraying and drying in the oven	64
Figure 3.9. Capsaicinoids distinctly identified following oven treatment	65
Figure 3.10. Chromatography at the end of oven drying	65

Figure 3.11. Chromatography of pure capsaicin	66
Figure 3.12. Thin layer chromatography	66
Figure 4.1. Mean reaction time of thermal analgesia in rats pre-treated with CFE or CPF	78
Figure 4.2. Percentage inhibition of thermal pain in rats pre-treated with CFE or CPF	79
Figure 4.3. Percentage inhibition of abdominal writhing responses in rats pre-treated with CFE or CPF	79
Figure 5.1. Degree of anti-inflammatory effects of CFE or CPF in rats	91
Figure 6.1a. Trace showing escalated concentrations of CPF on chick Oesophagus	104
Figure 6.1b-d. Concentration–response curve of ACh in chick isolated oesophagus with or without CFE or CPF	105
Figure 6.2a & b. Concentration–response curve of ACh in guinea-pig isolated ileum with or without CPF	107
Figure 6.3. Trace showing escalated concentrations of CPF on guinea-pig isolated ileum	108
Figure 6.4a. 1-3 Trace showing various concentrations of PFF on guinea-pig isolated ileum	109
Figure 6.5a1-4. Trace showing various concentrations of PFF on guinea-pig isolated ileum with or without atropine	111
Figure 6.5b & c. Concentration–response curve of ACh on rabbit isolated duodenum with or without CPF	114
Figure 7.1. Dose-dependent increases in INR using CFE or CPF dose range 5-10 mg/kg i.p.	125
Figure 7.2. Gastric erosion following capsaicin, 50 mg/kg (p.o).	126
Figure 7.3. Gastric erosion following chemical burns following 50 mg/kg capsaicin	126
Figure 8.1. Biphasic chronotropic effects of CFE or CPF on rats' Langendorf's hearts model	135
Figure 8.2. Regression analyses of capsaicin effects on rats' hearts rate	136
Figure 8.3 Best-line of fit for a slope of y-x axis showing decrease in heart	

rate following capsaicin administration in Langendorf's rat heart model	136
Figure 8.4. 1-5 LVDP/Time curves at time 2 to 21 minutes.	137
Figure 8.5. Mean changes in rats' dp/dt in capsaicin treatment	140
Figure 8.6. 1-4 Pathological slides of the effects of capsaicin on ischaemic-reperfusion injury	140
Figure 8.7. Degree of myocardial damage following ischaemia-reperfusion Injury	141
Figure 8.8. Correlation of left and right ventricular infarct size	141

1.5. REFERENCES

- Attal, N. (2001). Pharmacologic treatment of neuropathic pain. *Acta Neurologica Belgica*; 101(1): 53-64.
- Bernstein, S. Korman, N.J. Bickers, D.R. and Dahl, M.V. (1989). Topical capsaicin treatment of chronic post herpetic neuralgia. *Journal of the American Academy of Dermatology*; 21: 265-270.
- Bevan, S. and Geppetti, P. (1994). Protons: small stimulants of capsaicin-sensitive sensory nerves. *Trends in Neurosciences*; 7: 509-512.
- Campbell, E.A. Bevan, S. and Dray A. (1993). Clinical applications of capsaicin and its analogues. In: Wood J.N. (ed). *Capsaicin in the Study of Pain*. London: Academic Press; 255-272.
- Capsaicin Study Group, (1999). Treatment of painful diabetic neuropathy with topical capsaicin. A multi-centre, double blind, vehicle-controlled study. *Archives of Internal Medicine*; 151: 2225-2229.
- Caterina, M.J. and Julius, D. (2001). The vanilloid receptor: a molecular gateway to the pain pathway. *Annual Review of Neurosciences*; 24: 487-517.
- Coderre, T.J. and Melzack R. (1991). Central neural mediators of secondary hyperalgesia following heat injury in rats: neuropeptides and excitatory amino acids. *Neuroscience Letters*; 131(1): 71-14.
- Davis, J.B. Gray, J. Gunthorpe, M.J. Hatcher, J.P. Davey, P.T. Overend, P. Harries, M.H. Latcham, J. Clapham, C. Atkinson, K. Hughes, S.A. Rance, K. Grau, E. Harper, A.J. Pugh, P.L. Rogers, D.C. Bingham, S. Randall, A. and Sheardown, S.A. (2000.) vanilloid receptor-1 is essential for inflammatory thermal hyperalgesia. *Nature*; 405 (6783): 183-187.

- De Smet, PAGM. (2002). Effects of topical capsaicin in the treatment of painful osteoarthritis of the hands: herbal remedies. *New England Journal of Medicine*; 347:2046-2056
- Dickenson, A.H. (2002). Gate control theory of pain stands the test of time. Editorial. *British Journal of Anaesthesia*; 88 (6):755-757.
- Dray, A. (1992). Mechanism of action of capsaicin-like molecules on sensory neurons. *Life Sciences*; 51(23): 1759-1765.
- Epstein, J.B. and Marcoe J.H. (1994). Topical capsaicin for treatment of oral neuropathic pain and trigeminal neuralgia. *Oral Surgery Oral Medicine Oral Pathology*; 77: 135-140.
- Fusco, B.M. Geppetti, P. Fanciullacci, M. and Sicuteri, F. (1991). Local application of capsaicin for the treatment of cluster headache and idiopathic trigeminal neuralgia. *Cephalalgia*; 11: 234-235.
- Jaiarj, P. Saichompoo, S. Wongkrajang, Y. Vongswan, N. Peungvicha, P. and Jiratchariyakul, W. (1998). Cardiovascular actions of capsaicinoids extract from Thai Capsicum. *Thai Journal of phytopharmacy*; 5(2): 1-13.
- Marinelli, S. Di Marzo, V. Berretta, N. Matias, I. Maccarrone, M. Bernardi, G. and Mercuri, N.B. (2003). Presynaptic facilitation of glutaminergic synapses to dopaminergic neurons of the rat substantia nigra by endogenous stimulation of vanilloid receptors. *Journal of Neuroscience*; 23: 3136-3144.
- Melzack, R. and Wall, P.D. (1965). Pain mechanisms: A new theory. *Science*; 150: 971-9.
- Wallace, M.S. (1997). Advances in pain research. *Anaesthesiology Clinics of North America*; 15 (2): 229-234.

Winter, J. Bevan, S. and Campbell, E.A. (1995). Capsaicin and pain mechanisms. *British Journal of Anaesthesia*; 75: 157-168.

Wimalawansa SJ. Calcitonin gene-related peptide and its receptors: molecular genetics, physiology, pathophysiology, and therapeutic potentials. *Endocr Rev* 1996; 17: 533:81–85.

Preibisz JJ. CGRP and regulation of human cardiovascular homeostasis. *Am J Hypertens* 1993; 6: 434–50.

Zaidi M, Moonga BS, Bevis PJ, Bascal ZA, Breimer LH. The calcitonin gene peptides: biology and clinical relevance. *Crit Rev Clin Lab Sci* 1999; 28: 109.

Ye DZ, Wang DH. Function and regulation of endothelin-1 and its receptors in salt sensitive hypertension induced by sensory nerve degeneration. *Hypertension* 2002; 39: 673.

Cheng L., de la Monte S., Ma J., *et al* . (2009). HCl-activated neural and epithelial vanilloid receptors (TRPV1) in cat esophageal mucosa. *Am J Physiol Gastrointest Liver Physiol* 297;G135-G143.

McVey D.C., Vigna S.R. (2001). The capsaicin VR1 receptor mediates substance P release in toxin A-induced enteritis in rats. *Peptides* 22: 1439-1446.

McVey D.C., Schmid P.C., Schmid H.H., Vigna S.R. (2005). Endocannabinoids induce ileitis in rats via the capsaicin receptor (VR 1). *J Pharmacol Exp Ther* 304: 713-722.

Leonelli M., Martins D.O., Britto L.R.G. (2011). TRPV1 receptors modulate retinal development. *International Journal of Developmental Neuroscience*, 29(4)

Birder L.A., Nakamura Y., Kiss S., *et al* . (2002). Altered urinary bladder function in mice lacking the vanilloid receptor TRPV1. *Nat Neurosci.* ; 5:856-860.

Melck D., Bisogno T., De Petrocellis L., *et al* . (1999). Unsaturated long chain N-acyl-vanillyl-amides (N-AVAMS), vanilloid receptor ligands that inhibit anandamide-

facilitated transport and bind to CB1 cannabinoid receptors. *Biochem Biophys Res Commun.*; 262:275-284

Guo A., Vluchanova L., Wang J., *et al.* (1999) Immunocytochemical localization of the vanilloid receptor 1 (VR1), relationship to neuropeptides, the P2X3 purinoreceptor and IB4 binding sites. *Eur J Neurosc.* : 946-958.

Inuoe K., Koizumi S., Fuziwara S. *et al.* (2002) Functional vanilloid receptors in cultured normal human epidermal keratinocytes. *Biochem Biophys Res Commun*; 36:57-68.

Pare M, Elde R, Mazurkiewicz J.E. *et al.* (2001) The Meissner corpuscle revised, a multi afferent mechanoreceptor with nociceptor immunological properties. *J Neurosci*; 21: 7236-7246.

Appendino G., Harrison S., De Petrocellis L. *et al.* (2005) Development of the first ultra-potent “capsacinoid” agonist at transient receptor potential vanilloid type 1 (TRPV1) channels and its therapeutic potential. *J Pharmacol Exp Ther*; 312:561-570.

Avelino A., Cruz C., Nagy I. *et al.* (2002) Vanilloid receptor 1 expression in the rat urinary tract. *Neuroscience*; 109:787-798.

Tympanadis P., Casula M.A., Yiangou Y. *et al.* (2004) Increased vanilloid receptor VR 1 innervation in vulvodynia. *Eur J Pain*; 8: 129-133.

Szallasi A., Appendino G. (2001) Vanilloid receptor TRPV1 antagonists as the next generation of painkillers. Are we putting the cart before the horse? *J Med Chem*; 47: 2712-2723.

Szallasi A. (2000) Vanilloid receptors ligands, hopes and realities for the future. *Drugs Aging*; 18: 561-573.

Szallasi A., Di Marzo V. (2000) New perspectives on enigmatic vanilloid receptors. *Trends Neurosci*;23: 491-497.

Julius D., Basbaum A.L. (2001) Molecular mechanisms of nociception. *Nature*; 413:203-210.

Minke B., Cook B. (2002) TRP channel proteins and signal transduction. *Physiol Rev*; 82: 429-472.

Montell C., Birnbaumer L., Flockerzi V. *et al.* (2002) The TRP channels, a remarkably functional family. *Cell*; 108:595-598.

Blanes-Mira C., Merino J.M., Valera E. *et al.* (2004) Small peptides patterned after the N-terminus domain of SNAP25 inhibit SNARE complex Assembly and regulated exocytosis. *J Neurochemistry*; 88:124-135.

Caterina M.J., Leffler A., Malmberg A.B. *et al.* (2000) Impaired nociception sensation in mice lacking the capsaicin receptor. *Science*; 288:306-313.

CHAPTER 1

INTRODUCTION and BACKGROUND INFORMATION

SUMMARY: This chapter gives an overview of the aims and objectives of the study, and lays the ethical, phytochemical and biochemical foundation for the use of capsaicin in the present study.

1.1 OVERVIEW

The last half of the 20th century witnessed an upsurge in the knowledge of neurotransmitters. It made a significant contribution and advancement in pain management. It was discovered that the pain pathway is more complex than a common ascending afferent pathway whose messages were processed by a central mechanism at a specific pain center with an efferent effector mechanism through a descending pathway. In the same vein, both the autonomic and the neuro-humoral mechanisms are involved in pain mechanisms. The complex mechanisms of transmission and transduction of pain also involve several neurotransmitters, such as catecholamines, acetylcholine, vasoactive intestinal polypeptide (VIP), neuropeptide Y (NPY), cholecystikinin, 5-hydroxytryptamine, neurotensin, tachykinin, bradykinin and several others (Caterina and Julius, 2001). Specific genes called oncogenes- c-fos and v-fos are implicated in the memory of pain (Wallace, 1997). Recently, the non-adrenergic and non-cholinergic (NANC) neurotransmitters were discovered in the afferent and efferent pain pathways. Also, the peripheral and central mechanisms of endorphins, cyclo-oxygenase and the leukotrienes, are becoming evident.

However, the understanding of hyperalgesia, allodynia, and phantom or stump pain became obvious and evident with the discovery of N-methyldeamine aspartate (NMDA) receptors. Modulation of these receptors by specific antagonists has prevented the excitatory amino acids from gaining access to producing pain and neuronal injury (Marinelli, 2003). Such knowledge of the existence of non-specific excitatory and inhibitory systems in the central nervous system (CNS) has contributed to the development and use of co-analgesics and secondary analgesics in the relief of acute and chronic pain (Dray, 1992).

Although the 'gate control' theory of pain (Melzak and Wall, 1965) facilitated a better understanding of the perception and processing of pain by small and larger nociceptive fibers; Dickenson (2002) in an editorial affirmed that the latter theory had stood the test of time. Also, it was discovered that Substance P was released as the neurotransmitter at the primary afferent terminals of the dorsal root ganglion (DRG) (Caterina and Julius, 2001; Winter, *et. al* (1995)). Unfortunately, the lack of specific Substance P antagonists was frustrating. The centenarian study on the physiological effects of oily extracts from red peppers showed that capsaicin is the active Substance P antagonist (Capsaicin Study Group, 1999). It acts by depleting Substance P from its vesicles at the primary afferent neurons, following an initial increase in its concentration (Bevan, 1990). Ultimately, it reduces the duration and biological action of Substance P by tachyphylaxis.

Current research reports have shown that capsaicin exhibits various potent biological activities following oral or topical administration (Capsaicin Study Group, 1999). These include initial hyperalgesia (Coderre *et al.*, 1991; Davis *et al.*, 2000) analgesia, dyspepsia, anti-inflammatory (Attal, 2001); anti-pyretic and anti-coagulatory activities (Jaiarj *et al.*, 1998; De Smet, 2002). Furthermore, capsaicin can modulate endocrine and paracrine activities, immune responses, gastrointestinal, and cardiovascular functions (Jaiarj *et al.*, 1998). In addition, capsaicin has proved to be very useful in intractable pain of diabetic neuropathy (Bernstein *et al.*, 1989); cluster headache (Fusco, *et.al.* 1991; herpetic neuralgia and trigeminal neuralgia (Campbell *et al.*, 1993; Epstein and Marcoe, 1994).

Although red chilli peppers are cosmopolitan and various species are cultivated in southern Africa, research work in this field is limited locally. Apparently, imported capsaicin is very expensive. To this end, this study will advance the course of effective pain management by the use of local resources.

1.2. RESEARCH OBJECTIVES

The main aim of this study was to determine the pharmacodynamic effects of capsaicin from South African *Capsicum frutescens* Linn. (Family: Solanaceae).

The main objectives of this study were to:

- (i). Evaluate the analgesic properties of capsaicin;
- (ii). Determine the anti-inflammatory effects of capsaicin;
- (iii). Determine if capsaicin has effects on coagulation;
- (iv). Assess the effects of capsaicin on the cardiovascular system; and
- (v). Assess the effects of capsaicin on gastro-intestinal smooth muscles.

1.3. HYPOTHESIS

1.3.1. NULL HYPOTHESIS

Capsaicin extracted from local South African *Capsicum* has no analgesic, anti-inflammatory and anti-coagulant effects. It also lacks effects on the gastrointestinal and cardiovascular systems.

1.3.2. ALTERNATIVE NULL HYPOTHESIS

Capsaicin extracted from local South African *Capsicum* has analgesic, anti-inflammatory and anti-coagulant effects. It also has effects on the gastrointestinal and cardiovascular systems.

1.4. ORGANIZATION OF THE STUDY

There were three phases of this study. In the first phase, a study protocol and theoretical framework was laid down. Ethical approval was then obtained from the University's Animal Ethics Committee. The second phase involved identification of *Capsicum spp* and extraction of capsaicin. In the third phase, animal experiments were undertaken. Overall, the study has been presented in 9 chapters, in addition to an appendix.

1.5. REFERENCES

- Attal, N. (2001). Pharmacologic treatment of neuropathic pain. *Acta Neurologica Belgica*; 101(1): 53-64.
- Bernstein, S. Korman, N.J. Bickers, D.R. and Dahl, M.V. (1989). Topical capsaicin treatment of chronic post herpetic neuralgia. *Journal of the American Academy of Dermatology*; 21: 265-270.
- Bevan, S. and Geppetti, P. (1994). Protons: small stimulants of capsaicin-sensitive sensory nerves. *Trends in Neurosciences*; 7: 509-512.
- Campbell, E.A. Bevan, S. and Dray A. (1993). Clinical applications of capsaicin and its analogues. In: Wood J.N. (ed). *Capsaicin in the Study of Pain*. London: Academic Press; 255-272.
- Capsaicin Study Group, (1999). Treatment of painful diabetic neuropathy with topical capsaicin. A multi-centre, double blind, vehicle-controlled study. *Archives of Internal Medicine*; 151: 2225-2229.
- Caterina, M.J. and Julius, D. (2001). The vanilloid receptor: a molecular gateway to the pain pathway. *Annual Review of Neurosciences*; 24: 487-517.
- Coderre, T.J. and Melzack R. (1991). Central neural mediators of secondary hyperalgesia following heat injury in rats: neuropeptides and excitatory amino acids. *Neuroscience Letters*; 131(1): 71-14.
- Davis, J.B. Gray, J. Gunthorpe, M.J. Hatcher, J.P. Davey, P.T. Overend, P. Harries, M.H. Latcham, J. Clapham, C. Atkinson, K. Hughes, S.A. Rance, K. Grau, E. Harper, A.J. Pugh, P.L. Rogers, D.C. Bingham, S. Randall, A. and Sheardown, S.A. (2000.) vanilloid receptor-1 is essential for inflammatory thermal hyperalgesia. *Nature*; 405 (6783): 183-187.

- De Smet, PAGM. (2002). Effects of topical capsaicin in the treatment of painful osteoarthritis of the hands: herbal remedies. *New England Journal of Medicine*; 347:2046-2056
- Dickenson, A.H. (2002). Gate control theory of pain stands the test of time. Editorial. *British Journal of Anaesthesia*; 88 (6):755-757.
- Dray, A. (1992). Mechanism of action of capsaicin-like molecules on sensory neurons. *Life Sciences*; 51(23): 1759-1765.
- Epstein, J.B. and Marcoe J.H. (1994). Topical capsaicin for treatment of oral neuropathic pain and trigeminal neuralgia. *Oral Surgery Oral Medicine Oral Pathology*; 77: 135-140.
- Fusco, B.M. Geppetti, P. Fanciullacci, M. and Sicuteri, F. (1991). Local application of capsaicin for the treatment of cluster headache and idiopathic trigeminal neuralgia. *Cephalalgia*; 11: 234-235.
- Jaiarj, P. Saichompoo, S. Wongkrajang, Y. Vongswan, N. Peungvicha, P. and Jiratchariyakul, W. (1998). Cardiovascular actions of capsaicinoids extract from Thai Capsicum. *Thai Journal of phytopharmacy*; 5(2): 1-13.
- Marinelli, S. Di Marzo, V. Berretta, N. Matias, I. Maccarrone, M. Bernardi, G. and Mercuri, N.B. (2003). Presynaptic facilitation of glutaminergic synapses to dopaminergic neurons of the rat substantia nigra by endogenous stimulation of vanilloid receptors. *Journal of Neuroscience*; 23: 3136-3144.
- Melzack, R. and Wall, P.D. (1965). Pain mechanisms: A new theory. *Science*; 150: 971-9.
- Wallace, M.S. (1997). Advances in pain research. *Anaesthesiology Clinics of North America*; 15 (2): 229-234.

Winter, J. Bevan, S. and Campbell, E.A. (1995). Capsaicin and pain mechanisms.
British Journal of Anaesthesia; 75: 157-168.

CHAPTER 2

LITERATURE REVIEW

SUMMARY: This chapter gives an overview of the natural history of *Capsicum frutescens* and the climatic conditions favouring its growth. In addition, the receptor pharmacology of capsaicin and its role in pain pathways are discussed.

2.1.1. EVOLUTION and REVOLUTION OF PHYTOCHEMICALS

During the past century, medical science has improved with advancements in technology. However, the most effective tools for disease eradication may be found in edible fruits and vegetables. Phytochemicals, naturally occurring biochemicals that give plants their colour, flavour, smell and texture, may help prevent diseases that are responsible for over 50% of all deaths annually in the United States. In 1900, the top killer diseases responsible for 31% of all deaths were found to be pneumonia/influenza, tuberculosis, and diarrhoea/gastroenteritis (Taylor and Field, 1997; Stucky, *et.al.*, 1998). However, mortality reduced significantly consequent upon the improvement in public health, nutrition and sanitation. For example, influenza and pneumonia had a 70% drop in mortality from 12% to 3.6% per year. Although mortality had increased for stroke, cancer and heart diseases, there is increasing evidence that the exceptionally high death rates from the last three causes are preventable, and can be lowered with changes in diet, life-style, and environment. Phytochemical revolution took a positive turn in the 1970s onward, with the development of many laboratories that were involved in the production of bioactive nutraceuticals such as beta-carotene, omega-6 and other vitamins, with positive health deriving values. Capsaicin is a chilli pepper-derived spice. Apart from its spicy and flavourant properties, it has been found to be a digestive aid, a topical painkiller, and a potential cancer-fighting compound Winter *et al.*; 1995).

2.1.2 CAPSICUM -THE NATURAL HISTORY AND SCIENCE

'Capsicum' is synonymous with Chillies; Cayenne pepper; Red peppers; Spanish pepper; Mirch (Hindi); Capsicum fruits; *Fructus capsci*. Capsicum consists of the dried, ripe fruits of *Capsicum frutescens* Linn. (African Chillies) or, of *Capsicum annuum* Linn. Var *conoides* (Tabasco pepper), or of *Capsicum annuum* var, *longium* (Louisiana Long pepper), or a hybrid between the Honka variety of Japanese *capsicum* and the old Louisiana Sport Capsicum known as *Loisiana Sport pepper*. They all belong to the Family *Solanaceae* (Sofowora, 1993; Watt and Breyer-Brandwijk, 1962).

Capsicum is native to America, and the early Spanish explorers brought it to the 'New World'. It is cultivated in tropical regions of India, Nigeria, Japan, Southern Europe, Mexico, other African countries and Sri Lanka.

Capsicum is 5-12 cm long, 2-4 cm wide; and could be globular, cylindrical, oval, or oblong in shape. It has a shrivelled shape and could be orange, green, yellow or red in colour, with a prominent and bent pedicle. Internally, the fruits are divided into two halves by a membranous dissepiment to which the seeds are attached. Capsicum has a characteristic odour, and an intense pungent taste.



A T Jolayemi/2003

Figure 2.1. Different species of *Capsicum* and the finished products (spices) bottled.

Although *Capsicum* can withstand tropical heat, it requires 3 months rainfall, and thrives best in wet climate. The fruit yield is directly proportional to the manure of the cultivated farm.

The fruits are picked as they become fully ripe. The unripe fruits fade upon drying. The fruits are dried in sun and graded by colour. The quality of the fruit is in part determined by its colour, and they are occasionally oiled to give glossiness to their pericarps.

2.1.3. CHEMISTRY OF CAPSICUM

Capsicum contains fixed oils (0.1-1%). They are oleoresin, carotenoids, capsacutin, capsico (a volatile alkaloid), volatile oil (1.5%) and ascorbic acid (0.2%). The resin contains an extremely pungent principle, capsaicin, (decyclenic vinillylamide) (about 0.5%). Capsaicin retains its characteristic pungency in a dilution of 1 part in 10 million parts with water. The maximum concentration of capsaicin is in the inner walls. Its pungency is unaffected by alkalis, but it is destroyed by oxidising agents. Capsanthin is the main carotenoid of red fruits. It also occurs as monoester and diester along with cryptocapsin. Other carotenoids include zeaxanthin, lutein, cryptoxanthin, α and β -carotenes, and few xanthophylls. The carbohydrates reported in chillies are fructose, galactose, sucrose, fructosyl-sucrose, planteose, planteobiose, etc. Tocopherol (vitamin E) is present in trace amounts--~2.4 mg/100g.

The pungent compounds of *Capsicum frutescens* are capsaicin (69%), dihydrocapsaicin (22%), norhydrocapsaicin (7%), homocapsaicin (1%) and homodihydrocapsaicin (1%). The aromatic portion of capsaicin is derived from phenylalanine through frulic acid and vanillin. This aldehyde is a substrate for transamination to give vanilylamine. The acid portion of the amide structure is of polyketide origin, with a branched-chain fatty acyl-CoA, which is produced by chain extension of 2-methylacetyl-CoA. The starter unit is valine- derived.

2.1.4. MEASUREMENT OF PUNGENCY AND POTENCY OF CAPSICUM SPECIES

In 1912, Wilbur Scoville developed a dilution taste method, called “Scoville Organoleptic Test”, to measure the heat level of a chilli pepper. It consists of blended pure grounded chillies with sugar-sweetened solution, following which a panel of testers then sipped the concoctions. He increasingly diluted the concentrations until they reached the point at which the liquid no longer burned the mouth. A number was then assigned to each chilli based on how much it needed to be diluted before one could taste no heat.

The pungency of chilli pepper is measured in multiples of 100 units from the bell pepper (green or yellow *Capsicum annum*) at zero scoville units to the incendiary Habanero at 300,000 Scoville units. One part of chilli “heat” per 1,000,000 drops of water, rates as only 1.5 Scoville units. The substance that makes chilli so hot and therefore, so enjoyable, is capsaicin. Pure capsaicin rates over 150,000,000 Scoville units. Red Savina Habanero is much hotter than the normal Habanero with ‘Guinness Book of Records’ of 577,000 Scoville units while the Trinidad scorpion Moruga tests over 2 million Scoville units.

The validity and accuracy of the Scoville Organoleptic Test (SOT) have been widely criticised. The Gillet method adopted by the American Spice Trade Association and the International Organisation for Standardisation is a modified version of the SOT. Although very costly, the High Performance Liquid Chromatography is the most objective analysis for obtaining the purest form of capsaicin.

Capsaicin (N-Vanillyl-8-methyl-6- (E)-noneamide) is the most pungent of all the groups of compounds called “capsinoids” that can be isolated from chilli peppers. It is sparingly soluble in water but very soluble in fats, oils and alcohol.

2.1.5. USES OF CAPSAICIN

Capsaicin has been used externally as a stimulant, counter-irritant, rubefacient, in sore throat and scarlatina, hoarseness, dyspepsia, and yellow fever. Capsaicin is used as a carminative, stomachic, for atonic dyspepsia and flatulence. In the form of ointment, plaster, medicated wool, it is used for the relief of rheumatism, lumbago. The effect of capsaicin results from the activation of the vanilloid receptors, which ultimately activates the C fibre nerve endings, and thereby depletes the dorsal column of Substance P from its vesicles (Sofowora, 1993; Watt and Breyer-Brandwijk, 1962).

2.2. PHYSIOLOGY AND PHARMACOLOGY OF PAIN

Pain is perceived through both peripheral and central mechanisms. Peripheral mechanisms typically involve the nociceptors, while central mechanisms involve the process of central sensitization.

2.2.1. PAIN PATHWAYS

The pain pathways consist of the nociceptors, primary afferent neurons which transmit messages through the ascending nociceptive tracts, pain discriminating elements in the higher centres in the central nervous system (CNS), and an effector mechanism through the descending tracts. The nociceptors are free nerve endings which can be divided, using three criteria according to the degree of myelination, into A- α , A- β , A- γ , B and C fibers; type (s) of stimulation that evokes the response (into mechanical, chemical and thermal nociceptors), and the response characteristics. Some of the nociceptors have mixed functions, for example, certain C and *delta* fibers which act as mechano-thermal receptors. There are also some C and A α fibers which are insensitive to mechanical stimuli, but are sensitive to heat and cold, and to a variety of chemicals, such as bradykinin, hydrogen ions, serotonin, histamine, arachidonic acid and prostacyclin (Brenner, 2002). Using specific pain producing molecules, three different nociceptive fibers were found to be implicated in neuropathic pain; type I, type II and type III neurons. Type I

neurons are polymodal C-fibers, and they drive the NK 1-receptor mechanisms in spinal pain transmission. Type II neurons are also polymodal and they drive the NMDA receptor-mechanisms, while type III neurons are capsaicin insensitive, and possibly drive or markedly enhance the NMDA-receptor mechanisms (Decosterd and Woolf, 2002). Such pain transmission switch mechanisms are clearly consistent with clinical effectiveness, including less sensitivity to morphine and more sensitivity to NMDA-antagonists.

The neural impulses which originate from the nociceptors relay through the primary afferent nerves (PAN), to the spinal cord, or via the cranial nerves to the brain stem; for those impulses which originate from the head and neck. The cell bodies of these ganglia are located in the dorsal root ganglia, or the respective cell bodies in the cases of cranial nerves V, VIII, IX, and X. By means of complex synapses, messages are relayed to ascending pathways.

The ascending pathways consist of 10 laminae into which numerous types of cell bodies and dendrites converge. For example, the majority of nociceptors converge on laminae I (the marginal zone), laminae II (*substantia gelatinosa*) and lamina V in the dorsal horn. It is from these laminae that the second order neurons, which later re-organize into tracts respectively called “spinothalamic, spinothalamic” tracts, arise. The cranial nerves have their respective tract associations (Brenner, 2002; Decosterd and Woolf, 2002). The integration and higher processing of pain consists of discriminative component, affective component, memory, as well as the motor control of pain, which are effected in the thalamus, hypothalamus, limbic system, cerebral cortex and the cingulate cortex, respectively.

2.2.2. PHARMACOLOGY OF PAIN RECEPTORS

There are several biochemical mediators (and neurotransmitters), which are involved in pain transmission and perception. Peripherally, the most important of these amines are the cyclo-oxygenase agonists and the leukotrienes. Others are catecholamines, acetylcholine, vasoactive intestinal polypeptides (VIP), neuropeptides Y (NPY), cholecystokinin, 5-hydroxytryptamine, neurotensin,

tachykinin, and bradykinins (Miao and Levine, 1999; Nagy, 1985). The opioid receptors act both centrally and peripherally. In addition, the central cyclooxygenase action has been found with acetaminophen (Sinoff and Hart, 1993).

Centrally-acting neuromediators, can be classified into ‘excitatory,’ and ‘inhibitory,’ neuromediators. Glutamate and aspartate are the examples of excitatory amino acids acting as neurotransmitters centrally, while Substance P (SP), calcitonin gene-related peptide (CGRP) (Lou, *et al.*, 1991), and growth factors (e.g., brain-derived neurotrophic factors) are other examples. Inhibitory neuromediators include endogenous opioids, such as enkephalin and β -endorphins. Others are gamma-aminobutyric acid (GABA), glycine and α -adrenergic agonists (Nakamura and Shiomi, 1999). Conversely, any agent acting on these receptors and neuromediators have the ability to modulate pain. The aberration of inflammatory and neuropathic enhancement of pain perception as seen in allodynia (painful touch) and hyperalgesia are due to increased release of SP from *substantia gelatinosa*. This phenomenon is called ‘peripheral sensitization’.

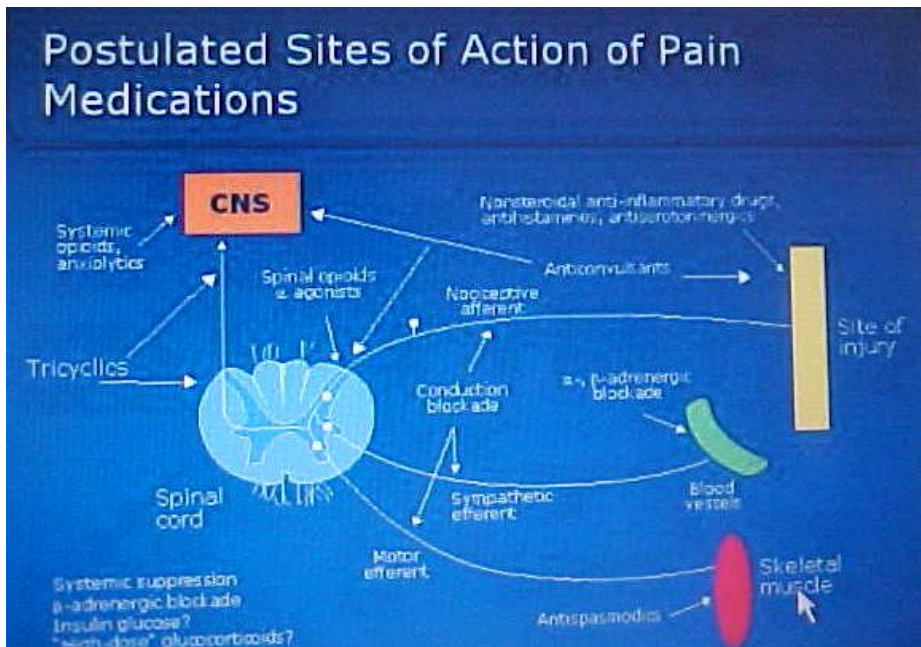

Figure 2.2. Multi-receptor and multi-synaptic pain mechanisms (Adapted from Bevan, S. Trends in Pharmacological sciences, 1990).

2.2.3 SUPRANUCLEAR PAIN RECEPTOR MODULATION

The memory of pain, neural plasticity, wide dynamic range activity and the winding phenomenon are enhanced by *N*-methyl-*D*-aspartate receptor through an early expression of genetic coding through *c-fos* and *v-fos* oncogenes (Woolf and Salter, 2000; Wallace, 1997; Chiang, *et al.*, 1997 and 1999). This neural plasticity leads to the phenomenon of central sensitization as typified by stump and phantom pain. Both hyperalgesia and allodynia, which are known side effects of capsaicin (Liu, *et al.* 1996), are results of peripheral and central sensitization. In addition, the repetitive C fiber stimulation produces the winding-up phenomenon.

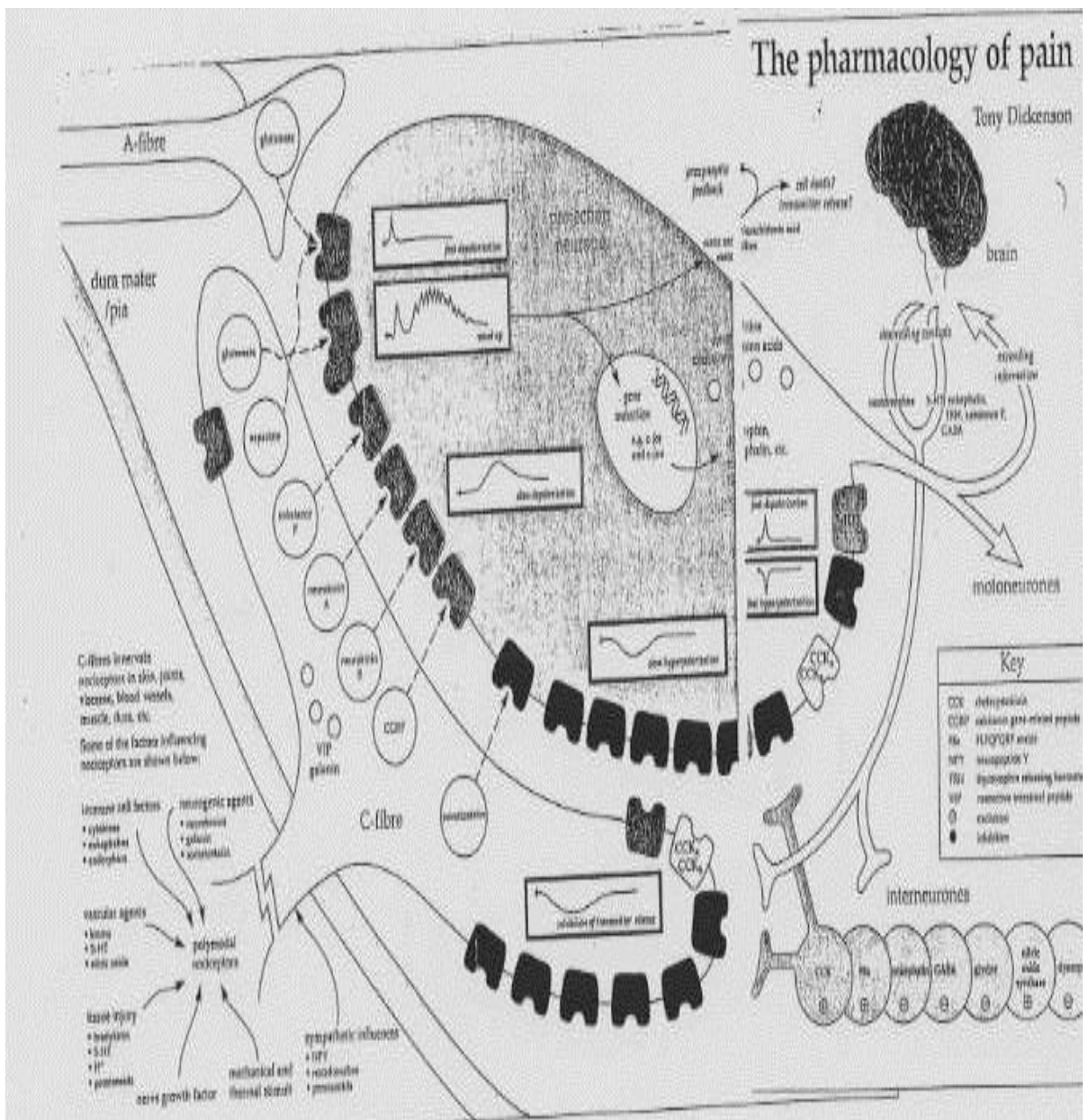

Figure 2.3. Multi-receptor concepts of pain pathway (Adapted from Elseviers Corporation, 1989)

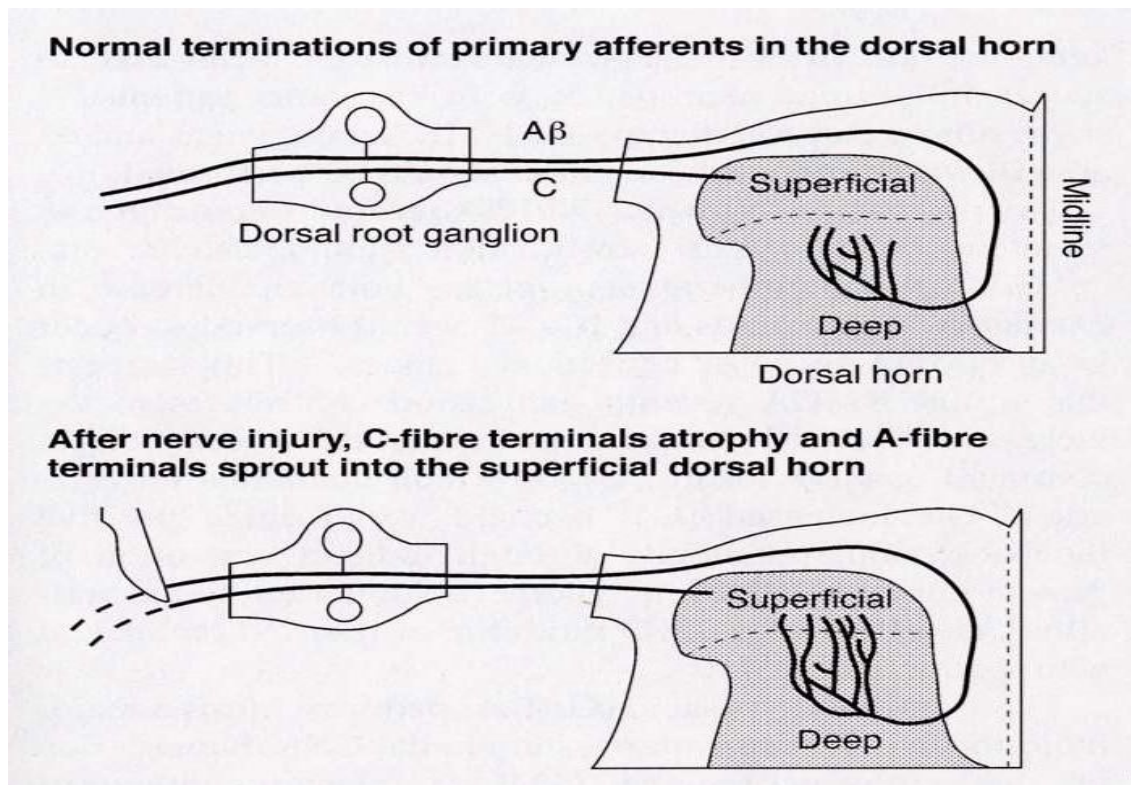

Figure 2.4 a & b. Injury leads to nociception, transduction, receptor modification, unco-ordinated spouting, and growth of injured axons and ectopic epileptic firing of nerves, (Figure 2.5 a & b. Adapted from Wallace, M.S.1997).

2.2.4. HIGHER CEREBRAL FUNCTION IN PAIN

Although the hypothalamus receives an enormous amount of stimuli, it is devoid of the ability to discriminate, since it is not somatotopically organized. It is also not able to localise pain. However, discrimination and localisation are possible by the third order neurons connecting to the prefrontal gyrus in the cerebral cortex. This is the basis for the use of secondary analgesia such as antidepressants and anticonvulsants.

2.2.5. PAIN ASSOCIATED AREAS IN THE BRAIN

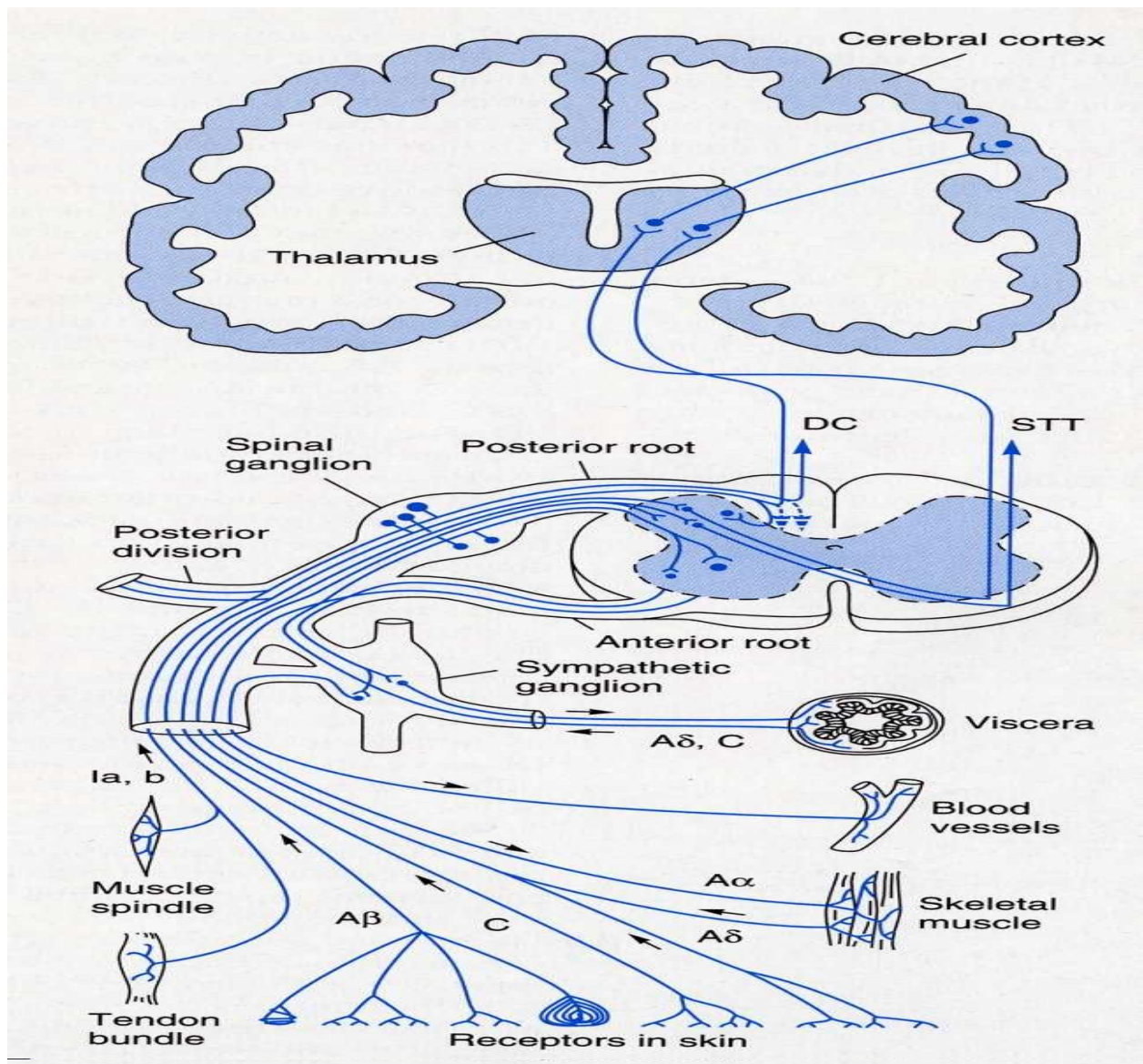

Figure 2.6. Ascending and descending pathways (Adapted from Sorkin, L.S. 1997).

Affect and mood contribute a great deal to pain perception. This is due to the connection of the limbic system, the cingulate cortex, and the cerebral cortex to the spinothalamic tract, the thalamus and the reticular formation. The ascending order is not alone in pain modulation. There is enough evidence to suggest that the descending tracts have a role in the modulation of pain (Decosterd and Woolf, 2002). In the late 1960s, it was observed that neurons in the dorsal horn of decerebrate animals are more responsive to painful stimuli when the spinal cord is blocked (Wall and Melzack, cited by Stojanovic, 2002). Also in the late 1980s,

electrical stimulation of the periaqueductal gyrus was found to produce profound relief of pain in animals (Wallace, 1997). These studies provided scientific basis for stimulation-produced analgesia. In addition, further studies showed that instillation of small doses of morphine in the regions such as periaqueductal system (PAG) produced significant analgesia.

2.2.6. SUMMARY OF PAIN MECHANISMS

Pain is sensed by nociceptors located in the sensory nerve endings. Messages are relayed through complex multisynaptic afferents to the dorsal column by means of transmission and transduction of chemical messages which are relayed via the spinal mechanisms and processed for appropriate supranuclear interpretation. Finally, the motor effector organs are facilitated to respond according to the type of pain (Vasko, 1995; Shipton, 1999).

2.3. PHYSIOLOGY AND PHARMACOLOGY OF SUBSTANCE P

Substance P is the active neurotransmitter that is released at the primary nerve endings of primary afferent neurons (PAN). It is usually synthesized at the *substantia gelatinosa* of the dorsal horn. On release from PAN, Substance P from the dorsal horn of the spinal cord exhibits systemic actions. For example, the expression of Substance P and vanilloid receptor (VR1) were found in the trigeminal sensory neurons projecting from PAN to the nasal mucosa in the mouse (Dinh *et al.*, 2003, Liu, *et al.* 2001). The release of both Substance P and neurokinin A (NKA) from PAN to various stimuli induced by capsaicin (vanilloid) receptor (VR1) results in potent pro-inflammatory effects on the airways (Toh, *et al.*, 1955; Davis *et al.*, 2000).

Expression of Substance P was found to correlate with the severity of diarrhoea in cryptosporidiosis from the result in electrogenic chloride anion secretion (Ritta and Dinh, 1993; Robinson, *et al.* 2003. Yang *et al.* (2003) found three kinds of current in response to Substance P in bullfrog dorsal root ganglion neurons. They are either G-protein coupled channel, slow activating I (SP); or directly opened

channel, fast activating I (SP); or both, moderately activating I (SP). All the three were inwardly directed currents with the ionic mechanism underlying slow activating I (SP) deduced as closure of K^+ channels. The fast-activating channel is due to the opening of sodium channels. These correlate with the three subtypes of SP receptor, immunoreactive interneurons described in the rat basolateral amygdala (Leibosohn, 1992). Furthermore, the secretion of HCO_3^- through secretin was abolished by Substance P (Hajos *et al.*, 1986; Gronroos *et al.*, 1997; Leis *et al.*, 2003).

Other systems affected by Substance P include the cardiovascular system. Low dose systemic administration of Substance P caused hypertension and tachycardia, while unilateral or bilateral injections into the rat's *nucleus tractus solitari* caused slow increase in blood pressure and heart rate, which peaked in 1.5-5 minutes after injection, and lasted for 20-30 minutes. These effects are vagal-mediated (Abdala *et al.*, 2003; Jaiarj *et al.*, 1998).

Furthermore, the swellings that typically accompany complex regional pain syndrome have been found to be due to extravasation of Substance P-induced protein (Levita *et al.*, 2003; Leis *et al.*, 2003).

2.4 HOW AND WHERE CAPSAICIN ACTS?

Capsaicin is the main pungent ingredient in 'hot' chilli peppers, and elicits a burning pain by selectively activating sensory neurons that convey information about noxious stimuli to the central nervous system (Naggy, 1995; Rang and Urban, 1995). However, capsaicin-induced ion refluxes increase cyclic GMP and not cyclic AMP (Wood, *et al.*, capsaicin has selective action on unmyelinated C-fibers and thinly-myelinated A primary sensory neurons (Wood, *et al.*, 1989).

Capsaicin-sensitive fibers are polymodal nociceptors, which respond to a variety of sensory stimuli, including noxious pressure, heat and chemical irritants. They are the most abundant class of nociceptive fibres. When stimulated by capsaicin, nociceptive neurones release glutamate, which is a rapidly-acting central neurotransmitter. In addition, these nociceptive fibers also express neuropeptides,

such as calcitonin-gene-related-peptide (CGRP), Substance P, neurokinin A and somatostatin, which, on release to the spinal cord, leads to intense stimulation. The tachykinins (e.g., Substance P and neurokinin A) and excitatory amino acids (EAAs) (e.g., glutamate), co-operate and are thought to increase synaptic activation of dorsal horn neurones via EAA receptors. Noxious stimulation acting on peripheral nervous system results in a long-term increase in spinal excitability, which results in the central mechanisms of allodynia and hyperalgesia. Most of the neuropeptides synthesized in the dorsal root ganglion are exported peripherally and not centrally, to facilitate neurogenic inflammation. Capsaicin pre-treatment in neonatal rats has been found to abolish the development of thermal hyperalgesia produced in a model of neuropathic pain in rats (Toth-Kasa *et al.*, 1986; Docherty, *et al.*, 1991).

An initial local application of capsaicin is analgesic (Kinnman, *et al.*, 1997). However, its repeated application leads to desensitization, and its high concentration eventually blocks conduction of the C-fibres. This results in long-lasting sensory deficits. These properties give a logical basis for the use of capsaicin in treating pains that arise from cluster headache, complex regional pain syndrome, post-mastectomy pain, post herpetic neuralgia, and diabetic neuropathy (Sicuteri, *et al.*, 1989; Karlstein and Gordh, 1997; Scheffler, *et al.* 1991).

2.5. INTERACTION OF SUBSTANCE P, CAPSAICIN, VANILLOID RECEPTORS AND OTHER RECEPTORS

2.5.1. CAPSAICIN RECEPTOR

Caterina *et al.*, (1997) used expression-cloning strategy based on calcium influx to isolate a functional cDNA encoding of a capsaicin receptor from sensory neurons. Capsaicin receptor is a non-selective cation channel, that is structurally identified with members of the Transient-Receptor-Potential V1 (TRPV1) family of ion channels (Caterina, *et al.* 2001; Cesare, *et al.* 1999; Chaundry, *et.al.*, 2001). The cloned-capsaicin receptor is also activated by increases in temperature in the noxious range, which suggests that it acts as a transducer of painful thermal stimuli *in vivo*.

In all, twenty-eight (28) mammalian Transient Receptor Potential (TRP) cation channels have been identified and re-grouped into six subfamilies (Vriens J, Appendino G, Nilius B; 2008). These include, TRPC (“Canonical”), TRPV (vanilloid”), TRPM (“Melastatin”), TRPP (“Polycystin”), TRPML (“Mucolipin”), and TRPA (“Ankyrin”). The TRPV subfamily (vanilloid receptors) comprises channels critically involved in nociception and thermo sensing.

These receptors form a distinct subgroup of the transient receptor potential (TRP) family of ion channels. Members of the vanilloid receptor (TRPV) are activated by a diverse range of stimuli, including heat, protons, lipids, phorbols, phosphorylation, changes in extracellular osmolarity and/or pressure, and depletion of intracellular Ca²⁺ stores. However VR 1 remains the only channel activated by vanilloids such as capsaicin.

The TRPV 1 receptors have been found in the brain, spinal cord, and peripheral neurons, (Nakagawa H, 2006); eyes, (Leonelli M, 2011); smooth and cardiac muscles, vascular tissues, bronchial muscles, (Quest, J. A., 2004); GIT mucosa, (Barbara G, et al, 2003; and the urinary bladder, (Birder L. A., 2006).

Most mechanistic studies of capsaicin-induced activation of nociceptive neurones have been made, by using cultured sensory neurons and isolated nerves *in vitro* (Cheng L, *et al*, 2009; Mogil and Basbaum, 2000; Wood, *et al*, 1989; Woolf, *et al.*, 1989). These studies show that capsaicin induces depolarization, during which there is an increase in the permeability to cations, particularly to calcium and sodium ions. Using specific antagonists such as capsazepine on capsaicin and its analogues, such as olvanil, nuvanil and resiniferatoxin; pharmacodynamic and pharmacokinetic studies on capsaicin were made possible. Dray (1992) has shown that the mechanisms by which, capsaicin produces desensitization, and inactivation of sensory neurons include receptor inactivation, block of voltage-activated calcium channels, intracellular accumulation of ions leading to osmotic changes, and activation of proteolytic enzyme processes.

In their study on sensory neuron-specific actions of capsaicin, Bevan and Szolcsanyi (1990) observed that capsaicin acts specifically on a subset of primary afferent sensory neurons to open cation-selective ion channels, probably by interacting directly with a membrane receptor-ion channel. The investigators indicated that other plant products and resiniferatoxin have structural similarities to capsaicin, and open the same channels. However, they found resiniferatoxin to be 1000 times more potent than capsaicin. In addition, they found that capsaicin-sensitive neurones are involved in nociception, responsible for the neurogenic component of inflammatory response, and may also have efferent actions on peripheral target tissues. In addition to its excitatory actions, they reiterated that capsaicin can have subsequent antinociceptive and anti-inflammatory effects.

Besides TRPV1 receptors, TRPM (Transient Receptor Potential Melastatin) had been implicated in Magnesium haemostasis in both the kidney and the intestine, Hoenderop J.G, *et al*, (2007); Schlingmann K.P. *et al*, (2002); and Scmitz C., (2003). Mutations in TRPM6 have been found in inherited defects in Magnesium and Calcium uptake.

The relationship between the TRPV and TRPM receptors is complex. Both receptors co-localise in the brain and tissues. Moreover, similar chemicals and drugs are able to stimulate both receptors in like manner. For example anadenamide and arvanil act on cannabinoids CB1 (as antiproliferative of breast cancer) via the TRPM receptor as well as antagonize the TRPV receptors Melck D *et al*, (1999).

In their study on sensory neuron-specific actions of capsaicin, Bevan and Szolcsanyi (1990) observed that capsaicin acts specifically on a subset of primary afferent sensory neurons to open cation-selective ion channels, probably by interacting directly with a membrane receptor-ion channel. The investigators indicated that other plant products and resiniferatoxin have structural similarities to capsaicin, and open the same channels. However, they found resiniferatoxin to be 1000 times more potent than capsaicin. In addition, they found that capsaicin-sensitive neurones are involved in nociception, responsible for the neurogenic component of inflammatory response, and may also have efferent actions on peripheral target tissues. In addition

to its excitatory actions, they reiterated that capsaicin could have subsequent antinociceptive and anti-inflammatory effects.

2.5.2. EFFECT OF pH CHANGES ON CAPSAICIN ACTIVITY

In their study, Bevan and Winter (1995) found that at low pH, sensory neurones are stimulated, resulting in opening of ionic channels. Current evidence suggests that elevation of cations, including sodium and calcium ions, is activated through capsaicin channel itself (Peterson, *et al.*, 1989). There is the thought that protons can be the endogenous activators of such channels (Sann *et al.*, 1987). In ischaemic or inflamed tissues, pH can fall to such critical level, which, directly activate capsaicin-operated channels, and contribute to pain associated with pathological conditions (Bevan *et al.*, 1992; Hegyi, *et al.*, 2003).

Capsaicin antagonists, such as capsazepine and ruthenium red, block some proton and capsaicin-evoked responses, e.g., smooth muscle contraction and CGRP release from smooth and skeletal muscles (Robertson *et al.*, 1989; Bevan and Geppetti, 1994). It is not conclusive if the protons open capsaicin-operated channels directly or indirectly through the release of another mediator. Moreover, Baumann *et al.*, (1996) observed that both protons and capsaicin exert excitatory effects on human sensory neurons, and that by means of multiple membrane mechanisms, depolarization of cultured human dorsal root ganglion (hDRG) neurons occurs at low pH (Maggi *et al.* 1988; Roza and Reeh, 2001; Olah, *et al.* 2001). The investigators also observed that inhibition of resting membrane conductances contributes to low pH in some human DRG neurons.

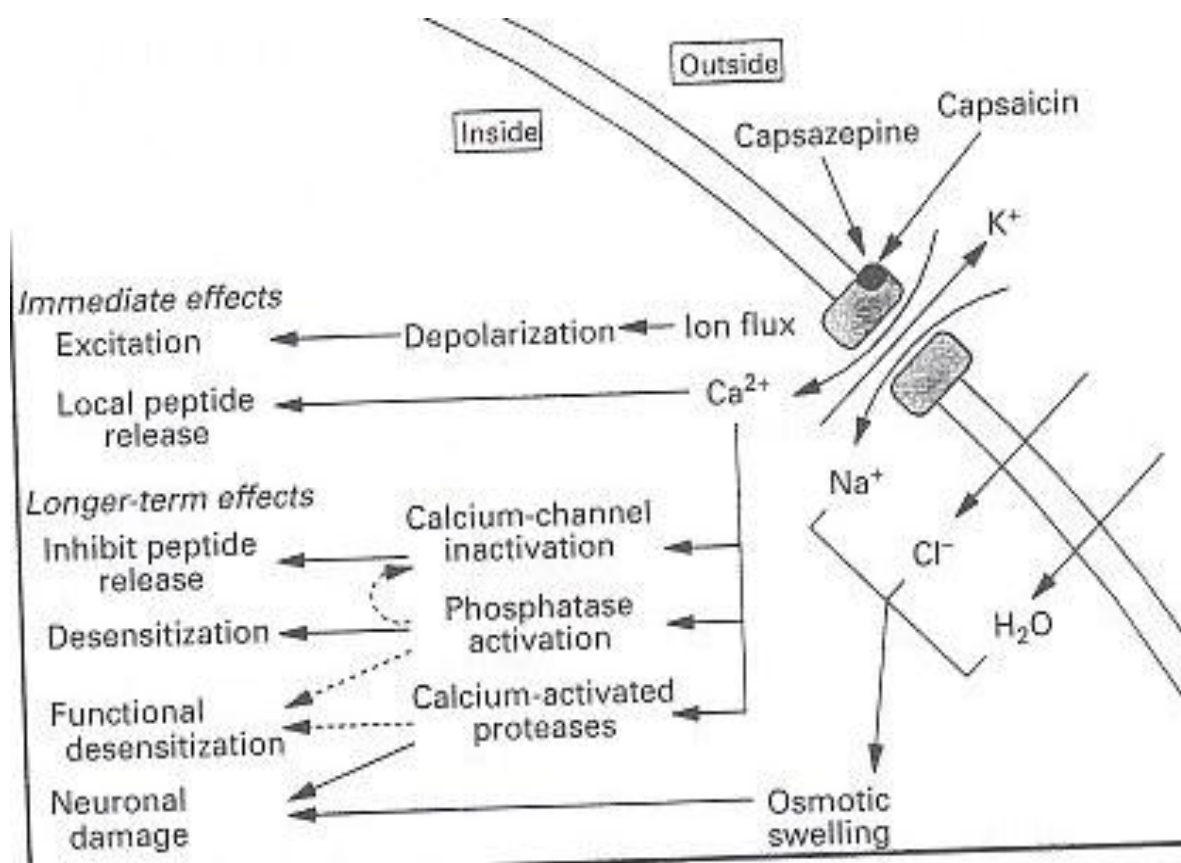

Figure 2.7. Some mechanisms of capsaicin action, Adapted from Wallace, M.S., (1997).

2.5.3. MODULATOR OF CAPSAICIN ACTIVITY

Capsaicin sensitivity has been found to be dependent on the continued presence of nerve growth factor (NGF), whose concentration increases in inflamed tissues (Bevan and Winter, 1995). Antibodies that neutralize NGF completely inhibit the development or reverse, established hyperalgesia (both mechanical and thermal) following injection of complete Freund's adjuvant (CFA) into the rat paw (Lindsay and Harmar, 1989; Treede, *et al.*, 1992; Woolf and Max, 2001). Furthermore, *in vivo* and *in vitro* studies have shown that NGF regulates several characteristics of nociceptive neurones, such as the content of neuropeptides, Substance P, and CRGP (Shir and Seltzer, 1990; Winter, *et al.*, 1993). The contribution of NGF-dependent up-regulation of capsaicin or proton sensitivity to inflammatory hypersensitivity is, however, not known.

2.5.4. CAPSAICIN AND NEURAL DESENSITIZATION

The role of capsaicin in desensitization of nociceptive neurones has been reviewed (Holzer, 1991). Two distinct modes of desensitization have been found. One of them is a classic pharmacological desensitization, where prolonged and repeated application of capsaicin leads to a progressive decline in the size of subsequent responses to capsaicin. The other is a functional desensitization, where a challenge with capsaicin leads to a reduction, or loss of responsiveness of, the neurone to other stimuli. Both modes occur together, but can be differentiated at low concentrations, at which end-point responsiveness to capsaicin is reduced or lost selectively, and responses to other stimuli are unchanged (Dray, 1992; Drummond, 1998). Functional desensitization seen at higher concentrations of capsaicin is the basis for the analgesic and anti-inflammatory effects of capsaicin.

The process of desensitization is calcium-dependent, as it does not take place when calcium is removed from the extracellular medium (Yeats, *et al.*, 2003; Sann *et al.*, 1987; Cholwinski *et al.*, 1993). The increase in intracellular calcium produced by capsaicin promotes desensitization by stimulating calcium- and calmodulin-dependent cytosolic enzyme and protein phosphatase 2B (calcineurin). Calcineurin is inhibited by a complex of cyclosporin A, and its cytoplasmic binding protein, cyclophilin (Winter *et al.*, 1995). Cyclosporin-cyclophilin complex abolishes capsaicin desensitization when introduced into the cytoplasm of rat sensory neurones. Increase in intracellular cyclic AMP increases capsaicin responses in sensory neurons (Yeats *et al.*; 1992; Ritta and Dinh, 1993; Yoshimura *et al.*, 2000). This observation suggests that sensitivity to capsaicin is regulated by phosphorylation of a key intracellular protein, which could be the receptor ion channel, or an associated protein (Lou *et al.*, 1992; Mapp and Kidd, 1994). It was thus observed that capsaicin-induced functional desensitization requires the presence of extracellular calcium (Mapp and Kidd, 1994), which capsaicin antagonist, ruthenium red, blocks (Maggi *et al.*, 1993; Attal, 2001).

Furthermore, it has been observed that capsaicin stimulates the release of excitatory amino acids (EAAs); such as glutamate and neuropeptides (CGRP, neurokinin A and Substance P), from both the peripheral and central terminals of sensory

neurones by two mechanisms (Gamse, 1982; Sann *et al.*, 1987; Lynn *et al.*, 1987; Kroll *et al.*, 1990; Del Bianco *et al.*, 1991; Lou *et al.*, 1992; 1994; Woolf *et al.*, 1994). The influx of calcium through capsaicin-activated ion channels triggers release of EAAs independent of action potential generation and propagation. Depolarization evoked by the agonist effect of capsaicin is propagated to distant regions of the nerve to release glutamate and neuropeptides. Capsaicin has a longer-term inhibitory effect, which is one likely mechanism for its analgesic and anti-inflammatory actions (Woolf, 2000; Bleakman *et al.*, 1990). Following capsaicin treatment, noxious stimuli no longer release glutamate and neuropeptides, despite the presence of near normal levels of neuropeptides in the nerves (Bevan and Geppetti, 1994). This inhibitory effect of capsaicin is due to a voltage-gated inhibition of calcium channels; thereby blocking the release of neurotransmitters from central and peripheral terminals (Rayner *et al.*, 1989; Bleakman *et al.*, 1990; Petersen and Rowbotham, 1999; Dinh *et al.*, 2003). Thus inhibiting the transmission of noxious signals between nociceptive sensory neurone and spinal cord neurons; and reducing or eliminating neurogenic inflammation evoked by neuropeptide release from peripheral nerve terminals. Inhibition of voltage-activated calcium currents in rat DRG leads to analgesia and anti-inflammatory effects that are restricted to capsaicin-sensitive neurones occurring at low concentrations of agonism. There may be other unknown mechanisms of functional nerve block, such as depolarization block of action potentials, which may contribute to the cell- and agonism-specific effects of capsaicin.

The effects of capsaicin on sensory neurones range from excitation to cell death. Many DRG neurones degenerate following neonatal capsaicin treatment. *In vitro*, the mechanisms of action of capsaicin-induced neurotoxicity was found to be osmotic, and partially through calcium entry, causing activation of calcium-sensitive proteases among other mechanisms (Chung *et al.*, 1990). *In vivo*, the severity of these effects depends on factors such as age of animal at the time of treatment, route of administration, and the dose of capsaicin used. Systemic administration destroys many DRG neurones in neonatal rats (Jansco, 1992). Also in adult rats, many C-fibre terminals degenerate (Chung *et al.*, 1985; Chung *et al.*, 1990) following large systemic doses, leaving many cell bodies to survive and regenerate (Lynn *et al.*, 1987; Pini *et al.*, 1990). Following perineural application of capsaicin, C fibres

degenerate distally with an extensive proximal axonal sprouting (Winter *et al.*, 1990; Winter *et al.*, 1993; Jancso and Jancso-Gabor, 1977). Although these damaged neurones in capsaicin-treated animals attempt to regenerate, they do not reinnervate, and the damage is essentially permanent. Following systemic capsaicin treatments, silver-staining method shows neurodegeneration in parts of the brain (Rayner *et al.*, 1989). It was also observed that following systemic capsaicin treatments, there was depletion of neuropeptides, Substance P and CGRP, enzyme flouride-resistant acid phosphatase (FRAP) from DRG neurones, and appearance of vasoactive intestinal peptide (VIP), similar to the effects of surgical axotomy (Hayes *et al.*, 1981; Jancso and Jancso-Gabor, 1997).

2.5.5. SUMMARY OF THE MECHANISMS OF THE ACTION OF CAPSAICIN

In summary, the mechanism of action of capsaicin is based on neuronal desensitization to noxious stimuli. Desensitization is a capsaicin-induced loss of responsiveness to further capsaicin treatment. It is reversible. Desensitization is calcium dependent, and probably involves activation of a phosphatase, which inactivates capsaicin channel.

Functional desensitization is a loss of sensitivity to a range of noxious stimuli, and underlies the analgesic effects of capsaicin. Functional desensitization is reversible, and may also depend on calcium-dependent dephosphorylation of other intracellular proteins, such as enzymes or ion channels.

Neurotoxicity is induced by high doses of capsaicin. Axonal and terminal degeneration and impaired nociception appear to be irreversible. Both osmotic lysis and action of calcium-dependent proteases may be responsible for capsaicin-induced neurotoxicity (Winter *et al.*, 1995; Cervero, *et al.* 1983; Nolano, *et al.*, 1999; Phylis, 1986).

In acute pain, studies in animals have shown that systemic capsaicin relieves pain in increasing doses from 0.5 mg/kg to 10 mg/kg, but nerve degeneration was noted in

doses of 50 mg/kg and greater. The relief was for mechano-thermal pain (Hayes *et al.*, 1981; Nagy and Van der Kooy, 1983; Jansco, 1992; Epstein and Marcoe, 1994). In human studies, it requires days to weeks before beneficial effects of capsaicin can be seen (Carpenter and Lynn, 1981; Colpaert *et al.*, 1983; Davis *et al.*, 2000).

With an increase in the levels of Substance P in inflammatory and neurogenic joint diseases (arthritis), topical or intra-articular injections of capsaicin have shown significant improvements, as well as reductions in level of inflammatory mediators (Colpaert *et al.*, 1983; Levin *et al.*, 1984; Marshall *et al.*, 1990; Davis and Perkins, 1994; Davis *et al.*, 2000). In the same vein, Perkins and Campbell (1992) used 6 mg/kg of intra-articular capsaicin to reverse mechanical hyperalgesia for several hours (Campbell *et al.*, 1993).

In rheumatoid arthritis, the effect of capsaicin is mixed. Whereas Deal *et al.* (1991) showed significant reduction in the level of pain intensity in 31 patients with rheumatoid arthritis of the knee following treatment with zostrix (as 0,025%) for 4 weeks, McCarthy and McCarty (1992) did not observe any improvement in 7 patients with rheumatoid hands, using 0.75% capsaicin. However, Weisman *et al.* (1994) reported that application of capsaicin (0.75%) for 6 weeks produced a reduction in inflammatory mediators, including Substance P, in the synovial fluid of patients with rheumatoid arthritis. In osteoarthritis, there is evidence to show increase in the level of Substance P in patients (Menkes *et al.* 1993; McCarty *et al.* 1994). Randomized, controlled trials have also shown significant improvement in pain relief following treatment with capsaicin cream (Deal *et al.*, 1991; Knight and Hayashi, 1994; Mapp and Kidd, 1994; McCleskey and Gold, 1996).

With neuropathic pain in mind, animal studies using intrathecal as well as subcutaneous or topical capsaicin have produced significant improvements in the relief of hyperalgesia and pain (Attal, 2001; Berring *et al.*, 1990; Kim *et al.*, 1992; Meller *et al.*, 1992; Sinoff and Hart, 1993; Winter *et al.*, 1995). These studies show that capsaicin-sensitive nerves have a role in thermal hyperalgesia in the animals under study (Winter *et al.*, 1995; Witting, *et al.*, 2000).

Studies in humans with neuropathic pain include patients with post-herpetic neuralgia (Berring *et al.*, 1990; Peikert *et al.*, 1991; Simone and Ochoa, 1991; Santicioli *et al.*, 1987; Lee and Gauci, 1994), diabetic neuropathy (Santicioli *et al.*, 1992; Capsaicin Study Group, 1999), and post-mastectomy pain (Dini *et al.*, 1993; Watson *et al.*, 1989; Watson and Evans, 1992; Watson *et al.*, 1993). Others include the use of capsaicin in stump or phantom pain (Rayner, *et al.*, 1989; Winter *et al.*, 1995; Baron, 1998); Complex Regional Pain Syndrome Type I (Siertsema *et al.*, 1988); Trigeminal Neuralgia (Fusco *et al.*, 1991); and oral neuropathic pain (Epstein and Marcoe, 1994). Capsaicin was also studied in cluster headache (Santicioli *et al.*, 1987, Fusco *et al.*, 1991; Epstein and Marcoe, 1994; Marks *et al.*, 1993), fibromyalgia (McCarty *et al.*, 1994), as well as in acute or chronic conditions, such as osteoarthritis (Deal *et al.*, 1991; McCleskey and Gold, 1996); and rheumatoid arthritis (Deal *et al.*, 1991), respectively.

Notable among these studies are those by the Capsaicin Study Group (1999) with a total of 277 patients (138 capsaicin 0.075%, 139 placebo) having diabetic neuropathy. The Group reported significant improvements in all measures (pain, walking, working, and sleeping) after administering capsaicin four times daily for up to eight weeks. In their study, Jensen and Larson (2001) found that capsaicin cream provides an alternative treatment option with a favourable outcome in painful diabetic neuropathy. Most of these studies were performed over similar periods of time, except the study by Watson *et al.* (1993), which followed up 83 patients with post-herpetic neuralgia for two years. The investigators found that in 86% of their patients, improvements in the pain scores were either maintained or further enhanced with no serious side effects. Furthermore, the efficacy of nasal application of capsaicin in the treatment of cluster headache had been confirmed following seven days application of capsaicin with significant improvement when compared with placebo. The relief might have been produced through the effects of capsaicin on Substance P-containing trigeminal nerve (Marks, 1993; Kowalsaki, 1999).

Capsaicin has also been shown to relieve pruritus in patients with psoriasis (Kurkcuoglu and Alaybeyi, 1990; Ellis *et al.*, 1993); brachioradial pruritus (Goodless and Eaglstein, 1993); aquagenic pruritus (Lotti *et al.*, 1994); notalgia parasthetica (Leibosohn, 1992); nodular prurigo (Goodless and Eaglstein, 1993);

and pruritus produced in patients on haemodialysis (Brand *et al.*, 1987). In human volunteers, capsaicin treatment was found to have inhibited itch after histamine and allergen challenge. Itch is mediated by a subset of capsaicin-sensitive nociceptive neurones through the inhibition of C fibre conduction (Lynn *et al.*, 1987; McMahon and Kotzenbeerg, 1992).

The wide systemic side effects have made topical capsaicin to be more acceptable in clinical state. The main side effects are neuronal, cardiovascular, muco-cutaneous tissue, or open wounds. Electron microscopic observations have revealed degeneration and glial engulfment of buttons and unmyelinated axons in the dorsal horn, 2-6 hours after neonatal subcutaneous capsaicin injections in rats. There is increased latency of the nerves; convulsion and even death may follow very high doses of capsaicin (Lee *et al.*, 1991; Simone, *et al.*, 1989). Cannabinoids have been used to attenuate capsaicin-evoked hyperalgesia (Johanek, *et al.*, 2001), and low dose lidocaine was found to reduce capsaicin-evoked secondary hyperalgesia by a central mechanism (Koppert, *et al.*, 2000).

When capsaicin is in contact with muco-cutaneous tissues, such as the conjunctiva, it produces intense inflammatory reaction (Surh and Lee, 1995). This is consequent upon the initial release of Substance P. Cardiovascular studies on blood vessels have shown that both capsaicinoids and capsaicin could inhibit vasoconstriction induced by norepinephrine (Kinnmann, *et al.* 1997), and the vasodilatation effect of capsaicinoids might be due to the action of capsaicin. The compounds also cause significant decreases in platelet aggregation induced by ADP and collagen; and increase blood flow in volunteers. During their study in Thailand, Jaiarj *et al.* (1998) first noticed that people who consume large amounts of red chilli peppers experienced a lower incidence of thrombo-embolism, or potentially dangerous blood clots.

The alternative to the mixed actions of capsaicin is being looked into through the development of purer and more potent capsaicin analogues (Szallasi and Blumberg, 1990). Brand *et al.* (1990) and Breneman *et al.* (1992) reported significant thermal and mechanical analgesia and anti-inflammatory activity following administration of olvanil oleamide, an analogue, which lacked the acute toxicity of capsaicin.

Nuvanil was found to be more soluble, thus allowing for oral administration, and also showed improved oral activity and significant analgesia (Yang, *et al.*, 1992; Yakish, 1999). The compounds were also found to show less pungency and reduced vagally mediated blood pressure reflexes (Brand *et al.* 1990; Breneman *et al.* 1992; Walpole *et al.* 1993; Hua *et al.* 1997; Jaiarj *et al.* 1998). In this regard, Lee *et al.* (1991) and Lee and Gauci, (1994) discussed how acute toxicity of capsaicin can be prevented through structural modification. Moreover, Chen *et al.* (1992) and Hua *et al.* (1997) also reported that orally active capsaicin analogue, civamide, showed a significant increase in response latency on the thermal withdrawal test that persisted for three days in adult rats.

In their three studies, Walpole *et al.* (1993) reported a series of structure-activity relationships based on different parts of capsaicin molecule, and described a rational basis for the design of compounds with increased potency. The investigators concluded that capsaicin antagonists, such as capsazepine and ruthenium red, inhibit capsaicin-induced analgesia and anti-inflammatory actions.

From the synopsis above, it is obvious that capsaicin is a cell-specific peripheral analgesic. Agonism, that is, the ability to open capsaicin-operated channels, is required for efficacy. There is a growing body of evidence for the efficacy of capsaicin in a number of painful conditions. A better window between analgesic doses and doses that produce side-effects is required for an orally-active therapeutic drug. However, topical applications of capsaicin are effective and without side-effects (Winter *et al.*, 1995; Bernstein, 1998). There is also a growing body of evidence for the role of capsaicin in inflammation, coagulation and gastro-intestinal function.

2.6. REFERENCES

- Abdala, A.P. Haibara, A.S. and Colombari, E. (2003). Cardiovascular responses to Substance P in the nucleus tractus solitarii: Microinjection study in conscious rats. *American Journal of Physiology of Heart and Circulation Physiology*; 285(2): 891-898.
- Appendino G., Harrison S., De Petrocellis L. *et al.* (2005) Development of the first ultra-potent “capsacinoid” agonist at transient receptor potential vanilloid type 1 (TRPV1) channels and its therapeutic potential. *J Pharmacol Exp Ther*; 312:561-570.
- Avelino A., Cruz C., Nagy I. *et al.* (2002) Vanilloid receptor 1 expression in the rat urinary tract. *Neuroscience*; 109:787-798.
- Attal, N. (2001). Pharmacologic treatment of neuropathic pain. *Acta Neurologica Belgica*; 101(1): 53-64.
- Attal, N. (2001). Molecular mechanisms of pain. *Sikagaku*; 73(4): 272-276.
- Baron, R. Wasner, G. and Lindner, V. (1998). Optimal treatment for phantom limb pain in the elderly; *Drugs and Aging*; 12(5): 361-376.
- Baumann, T.K. Simone, D.A. Shain, C.N. and LaMotte, R.H. (1991). Neurogenic hyperalgesia: The search for the primary cutaneous afferent fibers that contribute to capsaicin-induced pain and hyperalgesia. *Journal of Neurophysiology*; 66(1): 212-227.
- Baumann, T.K. Nurchiel, K.J. Ingram, S.L. and Martenson, M.E. (1996). Responses of adult human dorsal root ganglion neurons in culture to capsaicin and low p^H Pain; 65(1): 31-38.
- Blanes-Mira C., Merino J.M., Valera E. *et al.* (2004) Small peptides patterned after the N-terminus domain of SNAP25 inhibit SNARE complex Assembly and regulated exocytosis. *J Neurochemistry*; 88:124-135.

- Bernstein, S. Korman, N.J. Bickers, D.R. and Dahl, M.V. (1989). Topical capsaicin treatment of chronic post herpetic neuralgia. *Journal of the American Academy of Dermatology*; 21: 265-270.
- Bevan, S. and Szolcsanyi, J. (1990). Sensory neuron-specific actions of capsaicin: Mechanisms and applications. *Trends in Pharmacological Sciences*; 11(8): 331-333.
- Bevan, S.J. Hothi, S. Hughes, G.A. James, I.F. Rang, H.P. Shah, K. Walpole, C.J.S. and Yeats, J.C. (1992). A competitive antagonists of the sensory neurone excitant, capsaicin. *British Journal of Pharmacology*; 107: 544-552.
- Bevan, S. and Geppetti, P. (1994). Protons: Small stimulants of capsaicin-sensitive sensory nerves. *Trends in Neurosciences*; 17: 509-512.
- Bevan, S. and Winter J. (1995). Nerve growth factor differentially regulates the chemosensitivities of cultured adult rat dorsal root ganglion neurons. *Journal of Neuroscience*; in press.
- Birder L.A., Nakamura Y., Kiss S., *et al* . (2002). Altered urinary bladder function in mice lacking the vanilloid receptor TRPV1. *Nat Neurosci.* ; 5:856-860.
- Bleakman, D. Brorson, J.R. and Miller, R.J. (1990). The effects of capsaicin on voltage-gated calcium currents and calcium signals in cultured dorsal root ganglion cells. *British Journal of Pharmacology*; 101: 423-431.
- Bernstein, J.E. Korman, N.J. Bickers, D.R. Dahl, M.V. and Millikan, L.E. (1989). Topical capsaicin treatment of chronic herpetic neuralgia. *Journal of the American Academy of Dermatology*; 21: 265-270.
- Berring, P. Arendt-Nielsen, I. and Soderberg, U. (1990). Argon laser induced cutaneous sensory and pain thresholds in post-herpetic neuralgia. Quantitative modulation by topical capsaicin. *Acta Dermatology Venerology*; 70: 121-125.

- Brand, L.L. Berman, E. Schwen, R. Loomans M, Janusz, J. Bonne, R. Maddin, C. Gardner, J. LaHamn, T. Farmer, R. Jones, L. Chiaabrando, C. and Fanelli, R. (1987). NE-19950: A novel, orally active anti-inflammatory analgesic. *Drugs in Experimental and Clinical Research*; 13: 259-265.
- Brand, L.M. Skare, K.I. Loomans, M.E. Reller, H.H. Schwen, R.J. Lade, D.A. Bohne, R.L. Maddin, C.S. Moorehead, D.P. Fanelli, R. Chiabrando, C. Castelli, M.G. and Tai, H.H. (1990). Anti-inflammatory pharmacology and mechanism of the orally active capsaicin analogs, NE-19950 and NE-28345. *Agents and Clinical Research*; 31: 329-340.
- Breneman, D.L. Cardone, J.S. Blumack, R.F. Lather, R.M. Searle, E.A. and Pollack, V.E. (1992). Topical capsaicin treatment of hemodialysis-related pruritus. *Journal of the American Academy of Dermatology*; 26: 91-94.
- Brenner, G.J. (2002). Neural basis of pain. In: Ballantyne, J. Fishman, S.M. and Abdi, S.(eds). *The Massachusetts General Hospital Handbook of Pain Management* 2nd ed. Lippincott Williams & Wilkins; 3-18.
- Campbell, E.A. Bevan, S. and Dray, A. (1993). Clinical applications of capsaicin and its analogues. In: Wood, J.N. (ed). *Capsaicin in the Study of Pain*. London Academic Press; 255-272.
- Capsaicin Study Group, (1999). Treatment of painful diabetic neuropathy with topical capsaicin. A multi-centre, double blind, vehicle-controlled study. *Archives of Internal Medicine*; 151: 2225-2229.
- Carpenter, S.E. and Lynn, B. (1981). Vascular and sensory responses of human skin to mild injury after topical treatment with capsaicin. *British Journal of Pharmacology*; 73: 755-758.
- Caterina, M.J. Schumacher, M.A. Tominaga, M. Rosen, T.A. Levine, J.D. and Julius, D. (1997). The capsaicin receptor: A heat-activated ion channel in the pain pathway. *Nature*; 389 (6653): 783-784.

- Caterina, M.J. and Julius, D. (2001). The vanilloid receptor: A molecular gateway to the pain pathway. *Annual Review of Neuroscience*; 24: 487-517.
- Caterina M.J., Leffler A., Malmberg A.B. *et al.* (2000) Impaired nociception sensation in mice lacking the capsaicin receptor. *Science*; 288:306-313.
- Cervero, F. and McRitchie, H.A. (1983). Effect of neonatal administration of capsaicin in several nociceptive systems of the rat. In: Bonica J.J. Liebeskind, J.C. and Albe-Fessard, D.G. (eds) *Advances in Pain Research and Therapy*. New York: Raven Press; 4:87-94.
- Cesare, P. Moriondo, A. Vellani, V. and McNaughton, P.A. (1999). Ion channels gated by heat. *Proceedings of National Academy of Science USA*; 96(14): 7658-7663.
- Chaudhary, P. Martenson, M.E. and Baumann, T.K. (2001). Vanilloid receptor expression and Capsaicin excitation of rat dental primary afferent neurons. *Journal of Dental Research*; 80 (6): 1518-1523.
- Chen, I.J. Yang, J.M. Yeh, J.L. Wu, B.N. Lo, Y.C. and Chen, S.J. (1992). Hypotensive and antinociceptive effects of ether-linked and relatively non-pungent analogues of N-nonanoyl vanillylamide. *European Journal of Medicinal Chemistry*; 27: 187-192.
- Cheng L., de la Monte S., Ma J., *et al.* (2009). HCl-activated neural and epithelial vanilloid receptors (TRPV1) in cat esophageal mucosa. *Am J Physiol Gastrointest Liver Physiol* 297;G135-G143.
- Chiang, C.Y. Hu, J.W. and Sessle, B.J. (1997). NMDA receptor involvement in neuroplastic changes induced by neonatal treatment in trigeminal nociceptive neurons. *Journal of Neurophysiology*; 78(5): 2799-2803.
- Chiang, C.Y. Kwan, C.L. Hu, J.W. and Sessle, B.J. (1999). Effects of GABA receptor antagonist on trigeminal caudalis nociceptive neurons in normal

and neonatal capsaicin-treated rats. *American Physiological Society*; 82(5): 2154-2162.

Cholwinski, A. Burgess, G.M. and Bevan S. (1993). The role of calcium in capsaicin-induced desensitization in rat dorsal root ganglion neurons. *Neuroscience*; 55: 1015.

Chung, K. Schwen, R.J. and Coggeshall, R.E. (1985). Ureteral axon damage following subcutaneous administration of capsaicin in adult rats. *Neuroscience Letters*; 53: 221-226.

Chung, K. Klein, C.M. and Coggeshall, R.E. (1990). The receptive part of the primary afferent axon is most vulnerable to systemic capsaicin in adult rats. *Brain Research*; 511: 222-226.

Coderre, T.J. and Melzack, R. (1991). Central neural mediators of secondary hyperalgesia following heat injury in rats: Neuropeptides and excitatory amino acids. *Neuroscience Letters*; 131: 71-74.

Colpaert, F.C. Donnerer, J. and Lembeck, F. (1983). Effects of capsaicin in inflammation and on the Substance P content of nervous tissue in rats with adjuvant arthritis. *Life Sciences*; 32: 1827-1834.

Davis, A. and Perkins, M.N. (1994). The involvement of bradykinin B1 and B2 receptor mechanisms in Substance P-induced mechanical hyperalgesia in the rat. *British Journal of Pharmacology*; 113: Suppl. 26P.

Davis, A. and Perkins, M.N. (1995). Capsaicin-induced mechanical hyperalgesia in the rat: Involvement of NK1, bradykinin B1 and B2 receptors. *British Journal of Pharmacology*; 115: 684-688.

Davis, J.B. Gray, J. Gunthorpe, M.J. Hatcher, J.P. Davey, P.T. Overend, P. Harries, M.H. Latcham, J. Clapham, C. Atkinson, K. Hughes, S.A. Rance, K. Grau, E. Harper, A.J. Pugh, P.L. Rogers, D.C. Bingham, S. Randall, A. and

- Sheardown, S.A. (2000). Vanilloid receptor-1 is essential for inflammatory thermal hyperalgesia. *Nature*; 40 (6783):183-187.
- Deal, C.L. Schnitzer, T.J. Lipstein, E. Seibold, J.R. Stevens, R.M. Levy, M.D. Albert, D. and Renold, F. (1991). Treatment of arthritis with topical capsaicin: A double-blind trial. *Clinical Therapeutics*; 13: 383-395.
- Decosterd, I. and Woolf, C.J. (2002). Pain mechanisms and their importance in clinical practice and research. In: Ballantyne, J. Fishman, S.M. and Abdi S.(eds). *The Massachusetts General Hospital Handbook of Pain Management 2nd ed.* Lippincott Williams & Wilkins; 19-26.
- Del Bianco, E. Santicioli P, Tramontana M, Maggi C.A. Cecconi, R. and Geppetti, P. (1991). Different pathways by which extracellular Ca^{2+} promotes calcitonin gene-related peptide release from central terminals of capsaicin-sensitive afferents of guinea-pigs: effects of capsaicin, high K^+ and low p^H media. *Brain Research*; 566: 46-53.
- Dinh, Q.T. Groneberg, D.A. Mingomataj, E. Peiser, C. and Heptt, W. (2003). Expression of Substance P and vanilloid receptor (VR1) in trigeminal sensory neurons projecting to the mouse nasal mucosa. *Neuropeptides*; 37(4): 245-250.
- Dini, D. Bertelli, G. Gozza, A. and Forno, G.G. (1993). Treatment of post-mastectomy pain syndrome with topical capsaicin. *Pain*; 4: 223-226.
- Docherty, R.J. Robertson, B. and Bevan, S. (1991). Capsaicin causes prolonged inhibition of voltage-activated calcium currents in adult rat dorsal root ganglion neurons in culture. *Neuroscience*; 40: 513-521.
- Dray, A. Bettany, J. and Forster P. (1990). Actions of capsaicin on peripheral nociceptors of the neonatal rat spinal cord-tail in vitro: Dependence of extracellular ions and independence of second messengers. *British Journal of Pharmacology*; 101: 727-733.

- Dray, A. (1992). Mechanism of action of capsaicin-like molecules on sensory neurons. *Life Sciences*; 51(23): 1759-1765.
- Drummond, P.D. (1998). The effect of noradrenaline, angiotensin II and vasopressin on blood flow and sensitivity to heat in capsaicin-treated skin. *Clinics Autonomic Research*; 8(2): 87-93.
- Ellis, C.N. Berberian, B. Sulica, V.I. Dodd, W.A. Jarrat, M.T. Katz, I. Prawer, S. Krueger, G. Rex, I.H. and Wolf, J.E. (1993). A double-blind evaluation of topical capsaicin in pruritic psoriasis. *Journal of the American Academy of Dermatology*; 29: 438-442.
- Epstein, J.B. and Marcoe, J.H. (1994). Topical capsaicin for treatment of oral neuropathic pain and trigeminal neuralgia. *Oral Surgery Oral Medicine Oral Pathology*; 77: 135-140.
- Faulkner, D.C. and Growcott, J.W. (1980). Effects of neonatal capsaicin administration on the nociceptive response of the rat to mechanical and chemical stimuli. *Journal of Pharmacy and Pharmacology*; 32: 657-658.
- Fusco, B.M. Geppetti, P. Fanciullacci, M. and Sicuteri, F. (1991). Local application of capsaicin for the treatment of cluster headache and idiopathic trigeminal neuralgia. *Cephalalgia*; 11: 234-235.
- Gamse, R. (1982). Capsaicin and nociception in the rat and mouse. Possible role of Substance P. *Naunyn-Schmiedeberg's Archive of Pharmacology*; 320: 205-216.
- Goodless, D.R. and Eaglstein, W.H. (1993). Brachioradial pruritus: Treatment with topical capsaicin. *Journal of the American Academy of Dermatology*; 29: 783-784.

- Gronroos, M. Reunala, T. Kartamaa, M. and Pertovaara, A. (1997). Altered skin sensitivity in chronic itch: Role of peripheral and central mechanisms. *Neurosciences Letters*; 228 (3): 199-202.
- Guo A., Vluchanova L., Wang J., *et al.* (1999) Immunocytochemical localization of the vanilloid receptor 1 (VR1), relationship to neuropeptides, the P2X3 purinoreceptor and IB4 binding sites. *Eur J Neurosc.* : 946-958.
- Hajos, M. Svensson, K. Nissbrandt, H. Obal, F. Jr and Carlsson, A. (1986). Effects of capsaicin on central monoaminergic mechanisms in the rat. *Journal of Neural Transmission*; 66 (3-4): 221-242.
- Hayes, A.G. Scadding, J.W. Skingle, M. and Tyers, M.B. (1981). Effects of neonatal administration of capsaicin on nociceptive thresholds in the mouse and rat. *Journal of Pharmacy and Pharmacology*; 33: 183-185.
- Hegy, P. Gray, M.A. and Argent, B.E. (2003). Substance P inhibits bicarbonate secretion from guinea-pig pancreatic ducts by modulating an anion exchanger. *American Journal of Physiology and Cell Physiology*; 285 (2): C268-C276.
- Holzer, P. (1991). Capsaicin: Cellular targets, mechanisms of action, and selectivity for thin sensory neurons. *Pharmacological Reviews*; 43: 143-201.
- Hua, X.Y Chen, P. Hwang, J. and Yaksh, T.L. (1997). Antinociception induced by civamide: An orally active capsaicin analogue. *Pain*; 71(3): 313-322.
- Inoue K., Koizumi S., Fuziwara S. *et al.* (2002) Functional vanilloid receptors in cultured normal human epidermal keratinocytes. *Biochem Biophys Res Commun*; 36:57-68.
- Jaiarj, P. Saichompoo, S. Wongkrajang, Y. Vongswan, N. Peungvicha, P. and Jiratchariyakul, W. (1998). Cardiovascular actions of capsaicinoids extract from Thai capsicum. *Thai Journal of Phytopharmacy*; 5(2): 1-13.

- Jancso, G. K. and Jancso-Gabor, A. (1977). Pharmacologically induced selective degeneration of chemo-sensitive primary sensory neurons. *Nature*; 270: 741-743.
- Jansco, G. (1992). Pathological responses of C-fibre primary sensory neurons to peripheral nerve injury. *Experimental Physiology*; 77: 405-431.
- Jensen, P.G. and Larson, J.R. (2001). Management of painful diabetic neuropathy. *Drugs*; 18(10): 737-749.
- Johanek, L.M. Heitmiller, D.R. Turner, M. Nader, N. Hodges, J. and Simone, D.A. (2001). Cannabinoids attenuate capsaicin-evoked hyperalgesia through spinal and peripheral mechanisms. *Pain*; 93(3): 303-315.
- Julius D., Basbaum A.L. (2001) Molecular mechanisms of nociception. *Nature*; 413:203-210.
- Koppert, W. Ostermeier, N. Sittl, R. Weidner, C. and Schmelz M. (2000). Low-dose lidocaine reduces secondary hyperalgesia by a central mode of action. *Pain*; 85(1): 217-224.
- Kowalski, M.L. Dietrich-Milobedzi, A. Majkowska-Wojciechowska, B. and Jarzebska M. (1999). Nasal reactivity to capsaicin in patients with seasonal allergic rhinitis during and after the pollen season. *Allergy*; 54 (8): 804-810.
- Kinnmann, E. Nygard, E.B. and Hansson, P. (1997). Peripheral alpha-adrenoreceptors are involved in the development of capsaicin induced ongoing and stimulus evoked pain in humans. *Pain*; 69(1-2): 79-85.
- Karlstein, R. and Gordh T. (1997). How do drugs relieve pain? *Drugs Aging*; 11(5): 398-412.

- Kim, K.J. Jeon, B.H. Kim, W.S. Park, K.R. and Choi S. (1992). Effect of capsaicin on causalgiform pain in the rat. *Korean Journal of Physiology*; 26: 143-150.
- Knight, T.E. and Hayashi T. (1994). Solar (brachioradial pruritus)-response to capsaicin cream. *International Journal of Dermatology*; 33: 206-209.
- Kroll, F. Karlsson, J.A. Lundberg, J.M. and Persson, C.G. (1990). Capsaicin-induced bronchoconstriction and neuropeptide release in guinea-pig perfused lungs. *Journal of Applied Physiology*; 68: 1679-1687.
- Kurkccuoglu, N. and Alaybeyi, F. (1990). Topical capsaicin for psoriasis. *British Journal of Dermatology*; 123: 549-550.
- Lee, S.S. Sohn, Y.W. Yoo, E.S. and Kim, K.H. (1991). Neurotoxicity and long lasting analgesia induced by capsacinoids. *Journal of Toxicology Science*; 1: 3-20.
- Lee, J.J. and Gauci, C.A. (1994). Postherpetic neuralgia: Current concepts and management. *British Journal of Hospital Medicine*; 52 (11): 565-570.
- Leibosohn, E. (1992). Treatment of nostalgia paresthetica with capsaicin. *CUTIS*; 49: 335-336.
- Leis, S. Weber, M. Isselmann, A. Schmelz, M. and Birklein F. (2003). Substance P-induced protein extravasation is bilaterally increased in complex regional pain syndrome. *Experimental Neurology*; 183 (1): 197-204.
- Leonelli M., Martins D.O., Britto L.R.G. (2011). TRPV1 receptors modulate retinal development. *International Journal of Developmental Neuroscience*, 29(4)
- Levin, J.D. Clarke, R. Devor, M. Helms, M.A. Moskpwitz, M.A. and Basbaum, A.I. (1984). Intraneuronal Substance P contributes to the severity of experimental arthritis. *Science*; 226: 547-549.

- Levita, L. Mania, I. and Rainnie, D.G. (2003). Subtypes of Substance P receptor immune-reactive inter-neurons in the rat basolateral amygdale. *Brain Research*; 981(1-2): 41-51.
- Lindsay, R.M. and Harmar, A.J. (1989). Nerve growth factor regulates expression of neuropeptide genes in adult sensory neurons. *Nature*; 337: 362-364.
- Liu, M. Max, M.B. Parada, S. Rowan, J.S. and Bennett, G.J. (1996). The sympathetic nervous system contributes to capsaicin-evoked mechanical allodynia but not pinprick hyperalgesia in humans. *Journal of Neuroscience*; 16(22): 7331-7335.
- Liu, L. Oortgiesen, M. Li, I. and Simon, S.A. (2001). Capsaicin inhibits activation of voltage-gated sodium currents in capsaicin-sensitive trigeminal ganglion neurons. *Journal of Neurophysiology*; 85(2): 745-758.
- Lotti, T. Teofoli, P. and Tsampau, D. (1994). Treatment of aquagenic pruritus with topical capsaicin cream. *Journal of the American Academy of Dermatology*; 30: 232-235.
- Lou, Y.P. Franco-Cereceda, A. and Lundberg, J.M. (1991). Omega-conotoxin inhibits CRGP release and broncho-constriction evoked by a low concentration of capsaicin. *Acta Physiologica Scandinavica*; 141: 135-136.
- Lou, Y.P. Franco-Cereceda, A. and Lundberg J.M. (1992). Different ion channel mechanisms between low concentrations of capsaicin and nicotine regarding peptide release from pulmonary afferents. *Acta Physiologica Scandinavica*; 146: 119-127.
- Lynn, B. Pini, A. and Baranowski, R. (1987). Injury of somatosensory afferents by capsaicin: Selectivity and failure to regenerate. In: Pubols, L.M. and Sessle, B.J. (eds). *Effects of injury on trigeminal and spinal somatosensory systems*. New York: Alan R, Liss, Inc; 115-124.

- Maggi, C.A. Patacchini, R. Santiciolli, P. Giuliani, S. Delbianco, F. Geppetti, P. and Meli, A. (1988). Protective action of ruthenium red toward capsaicin desensitization of sensory fibers. *Neuroscience Letters*; 88: 201-205.
- Maggi, C.A. Bevan, S. Walpole, C.S.J. Rang, H.P. and Guilliani, S. (1993). A comparison of capsazepine and ruthenium red as capsaicin antagonists in the rat isolated urinary bladder and vas deferens. *British Journal of Pharmacology*; 108: 801-805.
- Mapp, P. and Kidd, B. (1994). The role of Substance P in rheumatic disease. *Seminars in Arthritis and Rheumatism*; 23: Suppl 3, 3-9.
- Marks, D.R. Rapoport, A. Padla, D. Weeks, R. Rosum, R. Sheftell, F. and Arrowsmith F. (1993). A double-blind placebo-controlled trial of intranasal capsaicin for cluster headache. *Cephalalgia*; 13: 114-116.
- Marshall, K.W. Chiu, B. and Inman, R.D. (1990). Substance P and Arthritis: Analysis of plasma and synovial fluid levels. *Arthritis and Rheumatism*; 33: 87-90.
- McCarthy, G.M. and McCarthy, D.J. (1992). Effect of topical capsaicin in the painful osteoarthritis of the hands. *Journal of Rheumatology*; 19: 604-607.
- McCarty, D.J. Csuka, M. McCarthy, G. and Trotter, D. (1994). Treatment of pain due to fibromyalgia with topical capsaicin: A Pilot Study. *Seminars in Arthritis and Rheumatism*; 23: (Suppl 3) 41-47.
- McCleskey, E.W. and Gold, M.S. (1996). Ion channels of nociception. *Annual Review of Physiology*; 61: 835-856.
- McMahon, S.B. Lewin, G. and Bloom, S.R. (1991). The consequences of long-term topical capsaicin application in the rat. *Pain*; 44: 301-310.

- McMahon, S.B. and Kotzenberg, M. (1992). Itching for an application. Trends in Neurosciences; 15: 497-501.
- McVey D.C., Vigna S.R. (2001). The capsaicin VR1 receptor mediates substance P release in toxin A-induced enteritis in rats. Peptides 22: 1439-1446.
- McVey D.C., Schmid P.C., Schmid H.H., Vigna S.R. (2005). Endocannabinoids induce ileitis in rats via the capsaicin receptor (VR 1). J Pharmacol Exp Ther 304: 713-722.
- Meller, S.T. Gebhart, G.F. and Maves, T.J. (1992). Neonatal capsaicin treatment prevents the development of the thermal hyperalgesia produced in a model of neuropathic pain in the rat. Pain; 51(3): 317-321.
- Melck D., Bisogno T., De Petrocellis L., *et al* . (1999). Unsaturated long chain N-acyl-vanillyl-amides (N-AVAMS), vanilloid receptor ligands that inhibit anandamide-facilitated transport and bind to CB1 cannabinoid receptors. Biochem Biophys Res Commun.; 262:275-284
- Menkes, C.J. Renoux, M. Loussadi, S. Mauborgne, A. Bruxelles, J. and Cesselin F. (1993). Substance P (SP) levels in synovial tissue and synovial fluid from rheumatoid arthritis (RA) and osteoarthritis (OA) patients. Journal of Rheumatology; 20: 714-717.
- Miao, F.J. and Levine, J.D. (1999). Neural and endocrine mechanisms mediating noxious stimulus-induced inhibition of bradykinin plasma extravasations in the rat. Journal of Pharmacology and Experimental Therapeutics; 291(3): 1028-1037.
- Minke B., Cook B. (2002) TRP channel proteins and signal transduction. Physiol Rev; 82: 429-472.
- Mogil, J.S. Yu, L. and Basbaum, A.I. (2000). Pain genes? Natural variation and transgenic mutants. Annual Review of Neuroscience; 23:777-811.

- Montell C., Birnbaumer L., Flockerzi V. *et al.* (2002) The TRP channels, a remarkably functional family. *Cell*; 108:595-598.
- Nagy, J.I. Vincent, S.R. Staines, W.A. Fibiger H.C. Reisine, T.D. and Yamamura, H.I. (1980). Neurotoxic action of capsaicin on spinal Substance P neurons. *Brain Research*; 186 (2): 435- 444.
- Nagy, J.I, and Van der Kooy D. (1983). Effects of neonatal capsaicin treatment on nociceptive thresholds in the rat. *Journal of Neuroscience*; 3: 1145-1150.
- Nagy, J.I. (ed) (1985). Capsaicin action on the nervous system. In: *Neurotransmitters in action (Bousfield D)* Elsevier Biomedical Press- Amsterdam. *Trends in Neurosciences*; 180-187.
- Nakamura, A. and Shiomi, H. (1999). Recent advances in neuropharmacology of cutaneous nociceptors. *Japan Journal of Pharmacology*; 79(4): 427-431.
- Nolano, M. Simone, D.A. Wendelschafer-Crabb, G. Johnson, T. Hazen, E. and Kennedy, W.R. (1999). Topical capsaicin in humans: parallel loss of epidermal fibers and pain sensation. *Pain*; 81(1-2): 135-145.
- Olah, Z. Karai, L. and Iadarola, M.J. (2001). Anandamide activates vanilloid receptor 1 (VR1) at acidic p^H in dorsal root ganglia neurons and cells ectopically expressing VR1. *Journal of Biological Chemistry*; 276(33): 31163-31170.
- Peikert, A. Henrich, M. and Ochs, G. (1991). Topical 0.025% capsaicin in chronic post-herpetic neuralgia: Efficacy, predictors of response and long-term course. *Journal of Neurology*; 238: 452-456.
- Perkins, M.N. and Campbell, E.A. (1992). Capsazepine reversal of the antinociceptive action of capsaicin in vivo. *British Journal of Pharmacology*; 107(2): 329-333.

- Pare M, Elde R, Mazurkiewicz J.E. *et al.* (2001) The Meissner corpuscle revised, a multi afferent mechanoreceptor with nociceptor immunological properties. *J Neurosci*; 21: 7236-7246.
- Petersen, M. Wagner, G. and Pierau F.K. (1989). Modulation of calcium-currents by capsaicin in a sub-population of sensory neurons of guinea-pig. *Naunyn Schmiedeberg's Archives of Pharmacology*; 329: 184-194.
- Petersen, K.L. and Rowbotham, M.C. (1999). A new human experimental pain model: The heat/capsaicin sensitization model. *Neuroreport*; 10(7): 1511-1516.
- Pini, A. Baranowski, R. and Lynn, B. (1990). Long-term reduction in the number of C-fibre nociceptors following capsaicin treatment of a cutaneous nerve in adult rats. *European Journal of Neuroscience*; 2: 89-97.
- Preibisz JJ. CGRP and regulation of human cardiovascular homeostasis. *Am J Hypertens* 1993; 6: 434-50.
- Ralevic, V. Kendall, D.A. Jerman, J.C. Middlemiss, D.N. and Smart, D. (2001). Cannabinoid activation of recombinant and endogenous vanilloid receptors. *European Journal of Pharmacology*; 424 (3): 211-219.
- Rang, H.P. and Urban, L. (1995). New molecules in analgesia. *British Journal of Anaesthesia*; 75: 145-156.
- Rayner, H.C. Atkins, R.C. and Westerman, R.A. (1989). Relief of local stump pain by capsaicin cream. *Lancet*; 2: 1276-1277.
- Ritta, S. and Dinh, T.T. (1993). Capsaicin-induced degeneration in the rat brain and retina. In: Wood J.N. (ed). *Capsaicin in the study of pain*. London Academic Press; 105-138.

- Robertson, B. Docherty, R.J. and Bevan S. (1989). Capsaicin inhibits voltage-activated calcium currents in a sub-population of adult rat dorsal root ganglion neurons. *Society for Neurosciences Abstracts*; 15: 354.
- Robinson, P. Okhuysen, P.C. Chappel, C.L. Weinstock, J.V. Lewis, D.E. Actor, J.K. and White Jr, A.C. (2003). Substance P expression correlates with severity of diarrhoea in cryptosporidiosis. *Journal of Infectious Disease*. 15; 188 (2): 290-296.
- Roza, C. and Reeh, P.W. (2001). Substance P, calcitonin gene-related peptide and PGE2 co-released from the mouse colon: A new model to study nociceptive and inflammatory responses in viscera, in vitro. *Pain*; 93(3): 213-219.
- Sann, H. Harti, G. Pierau, F.K. and Simon E. (1987). Effects of capsaicin upon afferent and efferent mechanisms of nociception and temperature regulation in birds. *Canadian Journal of Physiology and Pharmacology*; 65(6): 1347-1354.
- Santicioli, P. Del Bianco, E. Geppetti, P. and Maggi, C.A. (1992). Release of calcitonin gene-related peptide-like (CRGP-LI) immunoreactivity from rat isolated isoleus muscle by low p^H, capsaicin and potassium. *Neuroscience Letters*; 143: 19-22.
- Santicioli, P. Patachini, R. Maggi, C.A. and Meli, A. (1987). Exposure to calcium-free medium protects sensory fibers by capsaicin desensitization. *Neuroscience Letters*; 80: 167-172.
- Scheffler, N.M. Sheitel, P.L. and Lipton, M.N. (1991). Treatment of painful diabetic neuropathy with capsaicin 0.075%. *Journal of the American Podiatric Medical Association*; 81: 288-293.

- Sicuteri, F. Fusco, B.M. Marabini, S. Caimpagnolo, V. Maggi, C.A. Geppett, P. and Fanciullaci, M. (1989). Beneficial effect of capsaicin application to the nasal mucosa in cluster headache. *Clinical Journal of Pain*; 5: 49-53.
- Siertsema, W.K. Berman, E.F. Farmer, R.W. and Maddin, C.S. (1988). The antinociceptive effect and pharmacokinetics of olvanil following oral and subcutaneous dosing in the mouse. *Life Sciences*; 43: 1385-1391.
- Simone, D.A. Baumann, T.K. and Lamotte, R.H. (1989). Late effects of prolonged topical capsaicin on cutaneous sensibility and neurogenic vasodilation in humans. *Pain*; 38: 99-107.
- Simone, D.A. and Ochoa J. (1991). Early and late effects of prolonged topical capsaicin on cutaneous sensibility and neurogenic vasodilatation in humans. *Pain*; 47: 285-294.
- Sinoff, S.E. and Hart, M.B. (1993). Topical capsaicin and burning pain. *Clinical Journal of pain*; 9: 70-73.
- Shipton, E. A. (1999). *Acute and Chronic Pain*, 2nd ed. New Oxford University Press; 10-56
- Shir, Y. and Seltzer, Z. (1990). A fibers mediate thermal mechanical hyperesthesia and allodynia and C-fibers mediate thermal hyperalgesia in a new model of causalgiform pain disorders in rats. *Neuroscience Letters*; 115: 62-67.
- Sofowora, A. (1993). Proteins. In: Sofowora, A.(ed). *Medicinal plants and traditional medicine in Africa*, 2nd edition, Spectrum Books, Ibadan, Nigeria; 218-220.
- Sorkin, L.S. (1997). Basic pharmacology and physiology in acute pain process. *Anaesthesiology Clinics of North America*; 15(2): 235-245.

- Stojanovic, M. (2002). Interventional treatment of Chronic Pain. In: Ballantyne, J. Fishman, S.M. and Abdi S. (eds). *The Massachusetts General Hospital Handbook of Pain Management 2nd ed.* Lippincott Williams & Wilkins; 19-26.
- Stucky, C.L. Abrahams, L.G. and Seybold, V.S. (1998). Bradykinin increases the proportion of neonatal rat dorsal root ganglion neurons that respond to capsaicin and protons. *Neuroscience*; 84 (4): 1257-1265.
- Surh, Y.J. and Lee, S.S. (1995). Capsaicin, a double-edged sword: Toxicity, metabolism, and chemoprotective potential. *Life Science*; 1995; 56(22):1845-1855.
- Szallasi, A, and Blumberg, P.M. (1990). Specific binding of resiniferatoxin: An ultrapotent capsaicin analog to dorsal root ganglion membranes. *Brain Research*; 524: 106-111.
- Szallasi A., Appendino G. (2001) Vanilloid receptor TRPV1 antagonists as the next generation of painkillers. Are we putting the cart before the horse? *J Med Chem*; 47: 2712-2723.
- Szallasi A. (2000) Vanilloid receptors ligands, hopes and realities for the future. *Drugs Aging*; 18: 561-573.
- Szallasi A., Di Marzo V. (2000) New perspectives on enigmatic vanilloid receptors. *Trends Neurosci*;23: 491-497.
- Taylor, S. and Field, D. (1997). *Sociology, Health, and Health Care*. In: *Sociology of Health & Health Care*. 2nd ed. Blackwell Scientific Publication-Oxford.
- The phytochemical collection, (2002). In *molecular expressions: The phytochemical collection*. <http://micro.magnet.fsu.edu/phytochemicals/index.html>

- Toh, C.C. Lee, T.S. and Kiang, A.K. (1955). The pharmacological actions of capsaicin and analogs. *British Journal of Pharmacology*; 10: 175-182.
- Toth-Kasa, I. Jancso, G. Bognar, A. Husz, S. and Obal, F. (1986). Capsaicin prevents histamine-induced itching. *International Journal of Clinical Pharmacological research*; 6: 163-169.
- Treede, R.D Meyer, R.A. Raja, S.N. and Campbell, J.N. (1992). Peripheral and central mechanisms of cutaneous hyperalgesia. *Progress in Neurobiology*; 38(4): 397-421.
- Tympanadis P., Casula M.A., Yiangou Y. *et al.* (2004) Increased vanilloid receptor VR 1 innervation in vulvodynia. *Eur J Pain*; 8: 129-133.
- Vasko, M.R. (1995) Prostaglandin-induced neuropeptide release from spinal cord. *Progress in Brain Research*; 104: 367-380.
- Wallace, M.S. (1997). Advances in Pain Research. *Anaesthesiology Clinics of North America*; 15(2): 229-234.
- Walpole, C.S.J. Wrigglesworth, R. Bevan, S. Cambell, E.A. Dray, A. James, I.F. Perkins, M.N. Reid, D.J. and Winter, J. (1993). Analogues of capsaicin with agonist activity as novel analgesic agents; structure-activity studies. 1. The aromatic "A region". *Journal of Medicinal Chemistry*; 36: 2362-2372.
- Walpole, C.S.J. Wrigglesworth, R. Bevan, S. Cambell, E.A. Dray, A. James, I.F. Perkins, M.N. Reid, D.J. and Winter J. (1993). Analogues of capsaicin with agonist activity as novel analgesic agents; structure-activity studies. 1. The amide bond "B-region". *Journal of Medicinal Chemistry*; 36: 2373-2380.

- Walpole C.S.J. Wrigglesworth, R. Bevan, S. Cambell, E.A. Dray, A. James, I.F. Perkins, M.N. Reid, D.J. and Winter J. (1993). Analogues of capsaicin with agonist activity as novel analgesic agents; structure-activity studies. 1.The hydrophobic side chain “C-region”. *Journal of Medicinal Chemistry*; 36: 2381-2389.
- Watson, C.P.N. Evans, R.J. and Watt, V.R. (1989). The post-mastectomy pain syndrome and the effect of topical capsaicin. *Pain*; 38: 177-186.
- Watson, C.P.N. and Evans, R.J. (1992). The post-mastectomy pain syndrome and topical capsaicin: A randomized trial. *Pain*; 51: 375-379.
- Watson, C.P.N. Tyler, K.L. Bickers, D.R. Millikan, L.E. Smith, S. and Coleman E. (1993). A randomized vehicle-controlled trial of topical capsaicin in the treatment of postherpetic neuralgia. *Clinical Therapeutics*; 15: 510-526.
- Watt, J.M. and Breyer-Brandwijk, M.G. (1962). The medicinal and poisonous plants of Southern and East Africa: 862-942.
- Weisman, M.H. Hagaman, C. Yaksh, T.L. and Lotz, M. (1994). Preliminary findings in the role of neuropeptides suppression by topical agents in the management of rheumatoid arthritis. *Seminars in Arthritis and Rheumatism*; 23; suppl 3:18-24.
- Wimalawansa SJ. Calcitonin gene-related peptide and its receptors: molecular genetics, physiology, pathophysiology, and therapeutic potentials. *Endocr Rev* 1996; 17: 533:81–85.
- Winter, J. Dray, A. Wood, J.N. Years, J.C. and Bevan, S. (1990). Cellular mechanism of action of resiniferatoxin: A potent sensory neuron excitotoxin. *Brain Research*; 520:131-140.

- Winter, J. Woolf, C. and Lynn, B. (1993). Degenerative and regenerative responses of sensory neurons to capsaicin-induced damage. In: Wood J.N. (ed). *Capsaicin in the Study of Pain*. London: Academic Press; 139-160.
- Winter, J. Bevan, S. and Campbell, E.A. (1995). Capsaicin and pain mechanisms; *British J of Anaesthesia* 75: 157-168.
- Witting, N. Svensson, P. Arendt-Nielsen, I. and Jensen, T.S. (2000). Repetitive intradermal Capsaicin: Differential effect on pain and areas of allodynia and punctate hyperalgesia. *Somatosensory Motor Research*; 17(1): 5-12.
- Wood, J.N. Coote, P.R. Minhas, A. Mullaney, I. McNeill, M. and Burgess G.M. (1989). Capsaicin-induced ion fluxes increase cyclic GMP but not cyclic AMP levels in rat sensory neurons in culture. *Journal of Neurochemistry*; 53: 1203-1211.
- Woolf, C.J. Bennett, G.J. Doherty, M. Dubner, R. Kidd, B. Koltzenburg, M. Lipton R. Loeser, J.D. Payne, R. and Torcbjork, E. (1989). Towards a mechanism-based classification of pain? *Pain*; 77: 227-229.
- Woolf, C.J. Safieh-Garabedian, B. Ma, Q.P. Crilly, P. and Winter J. (1994). Nerve growth factor contributes to the generation of inflammatory sensory hypersensitivity. *Neuroscience*; 62: 327-333.
- Woolf, C.J. and Salter, M.W. (2000). Neuronal plasticity: Increasing the gain in pain. *Science*; 288: 1765-1769.
- Woolf, C.J. and Max, M.B. (2001). Mechanism-based pain diagnosis: Issues for analgesic drug development. *Anaesthesiology*. (in press).
- Yang, J.M. Wu, B.N. and Chen, I.J. (1992). Depressor response of sodium nonivamide acetate: A newly synthesized non-pungent analogue of capsaicin. *Asia Pacific Journal of Pharmacology*; 7: 95-102.

- Yang, Y.L. Yao, K.H. Gu, Y.Z. Guan, B.C. and Li Z.W. (2003). Three kinds of current in response to Substance P in bullfrog DRG neurons. *Brain Research*; 981(1-2): 70-77.
- Yeats, J.C. Boddeke, H.W. and Docherty, R.J. (1992). Calcium dependent and independent de-sensitization in rat dorsal root ganglion neurons is due to activation of calcineurin. *British Journal of Pharmacology*; 107: 238P.
- Yeats, J.C. Docherty, R.J. and Bevan, S. (1992). Calcium-dependent and independent de-sensitization of capsaicin-evoked responses in voltage-clamped adult rat dorsal root ganglion (DRG) neurons in culture. *Journal of Physiology*; 446: 390P.
- Yoshimura, M. Yonehara, N. Ito, T. Kawai, Y. and Tamura, T. (2000). Effects of topically applied capsaicin cream on neurogenic inflammation and thermal sensitivity in rats. *Journal of the Peripheral Nervous System*; 5 (2): 116-117.
- Yakish, T.L. (1999). Spinal systems and pain processing: Development of novel analgesic drugs with mechanistically defined models. *Trends in Pharmacological Science*; 20: 329-337.
- Ye DZ, Wang DH. Function and regulation of endothelin-1 and its receptors in salt sensitive hypertension induced by sensory nerve degeneration. *Hypertension* 2002; 39: 673.
- Zaidi M, Moonga BS, Bevis PJ, Bascal ZA, Breimer LH. The calcitonin gene peptides: biology and clinical relevance. *Crit Rev Clin Lab Sci* 1999; 28: 109.

CHAPTER 3

MATERIALS AND METHODS

3.1. RESEARCH METHODOLOGY

Experimental procedures and protocols used in this study were approved by the Animal Ethics Committee of the University of Durban-Westville, Durban 4000, South Africa (now University of KwaZulu- Natal; Westville Campus), and conform to the “*Guide to the care and use of animals in research and teaching*” (published by the University of Durban-Westville, Durban 4000, South Africa).

3.2.1. EXPERIMENTAL PROTOCOLS

Experimental protocols were written so as to lay down the organisation of the study. The sequence of this study follows the following structure:

1. Purchase of *Capsicum frutescens* from a local market in Durban.
2. Identification of *Capsicum frutescens* by a Botanist (Prof. Himansu Baijnath).
3. Extraction and purification of *Capsicum frutescens* fruit.
4. Identification of capsaicin from *Capsicum frutescens* fruit extract by Nuclear Magnetic Resonance (NMR).
5. Pharmacodynamic studies on *Capsicum frutescens* fruit extract in laboratory animals.

3.2.2. PLANT MATERIAL AND PREPARATION OF EXTRACT

Capsicum frutescens Linn. (family: Solanaceae) fruits were purchased from Warwick market in Durban, South Africa. The fruits were identified and authenticated by a botanist, Professor Himansu Baijnath. A voucher specimen of the plant (with its ripe fruits) has been deposited in the University's Herbarium (JAT/01). The total weight of the dried red chilli pepper fruits purchased from the local market was 3 kg. Dry ripe fruits of the *Capsicum frutescens* were separated from the stalk, cleaned and pulverized, using a mechanical grinder. Two-and-a-half-kilogram of the powder was put in a big conical flask and exhaustively extracted sequentially in hexane, dichloromethane and ethylacetate. Preliminary pilot experiments show that the ethyl acetate extract contains active compounds (capsaicinoids). The ethyl acetate extract was concentrated in a rotary evaporator under reduced pressure to yield 298 gm (10% yields) of the crude extract. The ethyl acetate extract was further purified. NMR analysis of the yield shows 98% capsaicin. Throughout this study, the 98% capsaicin aqueous extract of *Capsicum frutescens* was used.

3.2.3. CHROMATOGRAPHIC FRACTIONATION

A portion of the crude ethyl acetate extract was subjected to column chromatography over silica gel with gradient elution using 10% ethyl acetate in hexane to 40% ethyl acetate. A total of 51 eluates (25 ml each) were collected and combined into 15 fractions on the basis of their TLC similarities. The non-polar fractions (1-3) were chlorophylls, etc; and were discarded. The semi-polar/polar fractions (4-15) were subjected to further column chromatography over silica gel with gradient elution (30% ethyl acetate in hexane to 50% ethyl acetate). TLC was carried out on pre-coated aluminium plates using Merck Si gel F254. The developed TLC plates were visualised under UV light (254 and 366 nm), and by spraying with anisaldehyde/sulphuric acid/alcohol solution, and heated at 110⁰C for 5 min. Appearance of blue to violet-blue colouration indicated the presence of triterpenoids, as previously reported (Hostettmann and Marston, 1995 cited by Wilson and Walker, 1999). NMR spectra (1D and 2D) were obtained on a Varian

300 (300 MHz) spectrometer, using the residual solvent peaks as internal standards (as shown in the Appendix; Figure A.VI.1.). The extraction flow chart is shown below.

FLOW CHART FOR THE EXTRACTION OF CAPSICINOIDS FROM *CAPSICUM Spp*

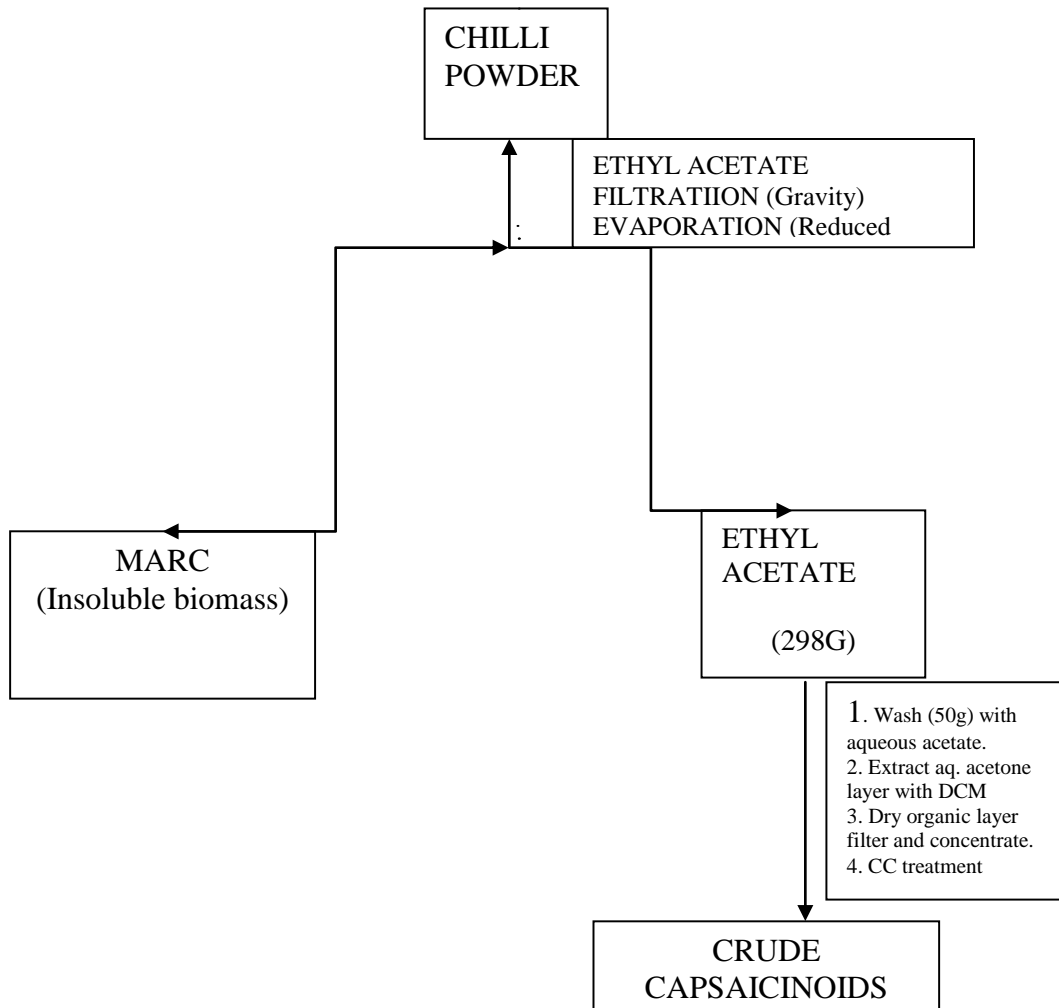

Figure 3.1. Flow chart: Extraction of capsaicinoids from *Capsicum* and chromatography of crude extracts of *Capsicum frutescens*.

DATE 24/06/03
 CODE NO DP /14
 QUANTITY OF EXTRACT: 5.042 G

Table 3.1. Composition of eluate from chromatography of *Capsicum frutescens*.

ELUATES	COMBINED FRACTIONS ON TLC BASIS	Wt (g)	GENERAL REMARKS
E 3	DP 14/k1	0.351	A mixture of 2 compounds
E 6	DP 14/K2	0.455	A mixture of 2 compounds
12	DP 14/K3	0.147	A mixture of 2 compounds
E18	DP 14/K4	0.108	A mixture of 2 compounds
E24	DP 14/K5	0.084	A pure sample
E 30	DP 14/K6	0.103	A mixture of 2 compounds
E 36	DP 14/K7	0.037	A pure sample
E39	DP 14/K8	0.055	A pure sample
E 42	DP 14/K9	0.211	A mixture of 2 compounds
E 45	DP 14/K10	0.011	A mixture of 4 compounds
E 48	DP 14/K11	0.38	A mixture of 2 compounds

Chromatography of crude extracts of *Capsicum frutescens*.

DATE 25/06/03

CODE NO DP /15

QUANTITY OF EXTRACT: ~ 2g

Table 3.2. Composition of eluate from extract of extract of *Capsicum frutescens*

ELUATES	COMBINED FRACTIONS ON TLC BASIS	Wt (g)	GENERAL REMARKS
E1- E4	DP 15/L1	0.142	A mixture of 2 compounds
E2-E17	DP 15/L2	0.218	A mixture of 4 compounds
13-E18	DP 15/L3	0.168	Pure sample
E14-E36	DP 15/L4	0.173	Pure sample
E32-E48	DP 15/L5	0.101	Pure sample
E49-E51	DP 15/L6	0.005	A mixture of 2 compounds

Chromatography of crude extracts of *Capsicum frutescens*.

DATE 27/06/03

CODE NO DP /16

QUANTITY OF EXTRACT: Unknown weight

Table 3.3. Composition of eluate from extract of *Capsicum frutescens*

ELUATES	COMBINED FRACTIONS ON TLC BASIS	Wt (g)	GENERAL REMARKS
E1-E3	DP 16/M1	0.305	A compound of 3 mixtures
E4-E6	DP 16/M2	0.452	A compound of 4 mixtures
E8-E12	DP 16/M3	0.821	A compound of 3 mixtures
E13-E18	DP 16/M4	0.328	A compound of 4 mixtures
E14-E21	DP 16/M5	0.153	A compound of 2 mixtures
E21-E22	DP 16/M6	0.208	A compound of 3 mixtures
E28-E42	DP 16/M7	0.053	A compound of 3 mixtures
E29-E43	DP 16/M8	0.523	A compound of 2 mixtures
E48-E54	DP 16/M9	0.088	A compound of 3 mixtures

Chromatography of crude extracts of *Capsicum frutescens*.

DATE 12/08/03

CODE NO DP /27

QUANTITY OF EXTRACT: Unknown weight.

Table 3.4. Composition of eluate from extract of *Capsicum frutescens*

ELUATES	COMBINED FRACTIONS ON TLC BASIS	Wt (g)	GENERAL REMARKS
E1-E6	DP 27/R1	0.002	Pure Sample
E7-E15	DP 27/R2	0.003	A mixture of 2 compounds
E6-E18	DP 27/R3	0.004	A mixture of 2 compounds
E19-E24	DP 27/R4	0.051	A mixture of 2 compounds
E25-E36	DP 27/R5	0.084	Pure sample
E31-E42	DP 27/R6	0.029	Pure sample
E43-E44	DP 27/R7	0.047	A mixture of 2 compounds
E40-E46	DP 27/R8	0.281	Pure sample
E52-E48	DP 27/R9	0.024	A mixture of 2 compounds



Figure 3.3. Filtration to remove extract of *Capsicum frutescens* fruit.

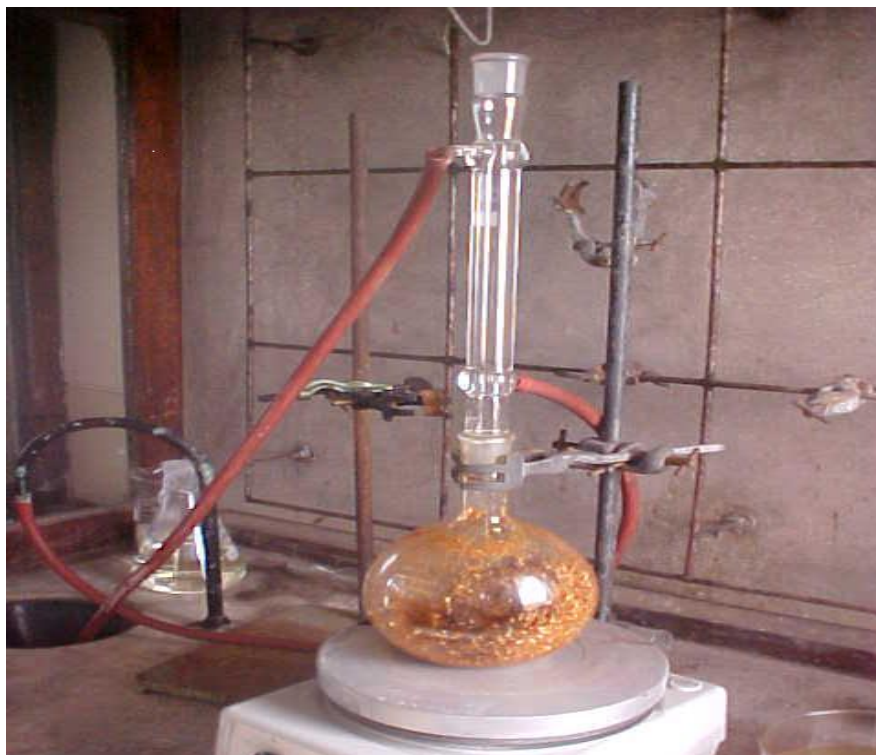

Figure 3.4. Gentle heating of powdered *Capsicum frutescens* fruit in the solvent (methanol or ethyl acetate).



Figure 3.5. Column chromatography and separation of capsaicinoids.” 3-4 different substances can be identified according to colour.

3.3. CHROMATOGRAPHY

Chromatograph is one of the various techniques used for the separation of complex mixtures that rely on differential affinities of substances for a gas or liquid mobile medium, and for a stationary adsorbing medium through which they pass (such as paper, gelatin, or magnesia), [American Heritage Dic. of the English Language, 4th ed.].

3.3.1. BASIC PRINCIPLES

The basis for all forms of chromatography is the partition or distribution coefficient (k_d), which describes, the way a substance is distributed between two immiscible phases (Wilson and Walker, 1999). Any chromatography consists of a stationary and a mobile phase. The stationary phase may be solid, gel, or a solid/liquid mixture. In this study, the stationary surface is solid-silica. The mobile phase is usually gaseous or liquid, which flows over or through the stationary phase. In this study, the mobile medium was hexane, methanol, dichloromethane (DCM), or ethyl acetate.

The choice of stationary and mobile phases is such that the compounds to be separated have different distribution coefficients. There are various methods that can be used to achieve this, which includes the setting up of:

- (i) an adsorption equilibrium between the solid and liquid phases. Examples are adsorption and hydrophobic interaction chromatography, respectively.
- (ii) Partition equilibrium may be set-up between a stationary liquid phase and a mobile liquid phase, such as in partition chromatography; reversed-phase chromatography; ion-pair chromatography; chiral chromatography; gas chromatography and countercurrent chromatography.

In ion-exchange chromatography and chromatofocusing, ion-exchange equilibrium between a stationary ion exchanger and mobile electrolyte phase is set-up. In exclusion or gel chromatography; equilibrium is set-up between a liquid phase trapped inside the pores of a stationary porous structure, and a mobile liquid phase.

However, in affinity and immuno-affinity chromatography, equilibrium is set-up between a stationary immobilized ligand and a mobile phase. Other examples of this form of set-up are lectin affinity, metal-chelate; dye-ligand and covalent chromatography.

In practice, two or more of these equilibria may be involved simultaneously in a particular chromatographic separation. In the present study, both adsorption and partition equilibria were set-up between the mobile and stationary phases.

Movement of individual species from the mobile phase through the solid phase is affected by such retarding factors as the relative solubility, surface adsorption and the charge of the particles.

The two theories governing chromatographic processes are the 'rate' and 'plate' theories. In the plate theory, chromatographic column is treated as though it was a static system in equilibrium. Each system exhibits equilibrium between the mobile and stationary phase.

A mobile phase \leftrightarrow A stationary phase

The plate theory assumes that the chromatographic column is mathematically equivalent to a plate column. Equilibrium is established for the solute between the mobile and the stationary phase. It is a useful theory and can predict many aspects of chromatographic performance. From the foregoing, it will be seen that chromatography is useful for both quantitative and qualitative analysis. Quantitatively, chromatography depicts that there is a presence of a substance in the column; but it does not state the quantity of the substance. Qualitative analysis then shows what the quality of the substance is through electron capture or ion detector (Parbrook *et al.*, 1989; Sykes, *et al.*, 1999). In this study, Nuclear Magnetic Resonance (NMR) was used (in collaboration with the Chemistry Department of the University of KwaZulu-Natal) to identify the final extract, i.e. capsaicin.

Chromatographic separation can be achieved using three contrasting modes. They are column chromatography, thin layer chromatography and paper chromatography. In column chromatography, the stationary phase is attached to a suitable matrix (an inert, insoluble support) packed into a glass or metal column. The mobile phase is passed through the column either by gravity feed (as in this study) or by the use of a pumping system, or applied gas pressure. This is the most common form of chromatographic modes. In thin layer chromatography, the stationary matrix is coated thinly on to a glass, plastic or metal foil plate. The mobile liquid phase across

the thin-layer plate held either horizontally or vertically, is by capillary action. Its advantage is that a large number of samples can be studied simultaneously. In paper chromatography, the stationary liquid phase is supported by cellulose fibres of a paper sheet. Thin layer and paper chromatography have several similarities. In both modes, the mobile phase passes along the paper sheet either by gravity feed, or by capillary action. It is one of the older forms of chromatography, with few current serious biochemical applications.

The flow rate is determined by the physical dimensions of the column, (internal diameter, length), particle size, shape and porosity, and the viscosity of the mobile phase. In a liquid partition chromatographic column, the elution volume is related to the volume of the stationary phase, V_s , the distribution coefficient, k_d , of the analyte between the stationary and mobile phases, and to the void volume or dead space, V_M , of the mobile phase around, and within the packed stationary phase particles, by the equation:

$$V_R = V_M + K_d V_s$$

The surface area of the adsorbent, A_s , replaces V_s in adsorption column chromatography. V_R is the retention volume.

The most important parameters in column chromatography is the unitless capacity ratio. This is a measure of the time spent by the analyte in the stationary phase relative to the time spent in the mobile phase. It reflects column performance.

The success of a particular chromatographic system is determined by its ability to achieve good resolution which, is determined by the selectivity, efficiency and the capacity of the system. The 'selectivity' is a measure of the inherent ability of the system to discriminate between structurally related compounds. The 'efficiency' is a measure of the diffusion effects that occur in the column to cause peak broadening and overlap. The 'capacity' is a measure of the amount of material that can be resolved without causing peaks to overlap, irrespective of such action as gradient elution and temperature programming.

The stationary phase is packed according to standard procedure with matrices attached in a range of sizes and shapes. A 100-200 mesh is most common for routine use, or 200-400 mesh used for higher resolution work. Poor column packing gives rise to uneven flow (channeling) and reduced resolution.

In order to ensure that the chromatographic systems were up to standard, phase A of this study was conducted in the Chemistry Department under the supervision of a Professor of Analytical Chemistry (Prof. Francis O Shode).

3.4. OTHER TYPES OF CHROMATOGRAPHY

3.4.1. PAPER CHROMATOGRAPHY

In paper Chromatography, a high-quality filter paper is impregnated with a very sensitive indicator. Using capillary action, the solute dissolved in a solvent in which the paper is dipped, travels at different rates across the filter paper. The paper is fixed and dried in a fume chamber.



Figure 3.6. Paper chromatograph before drying in the oven held against a dark background

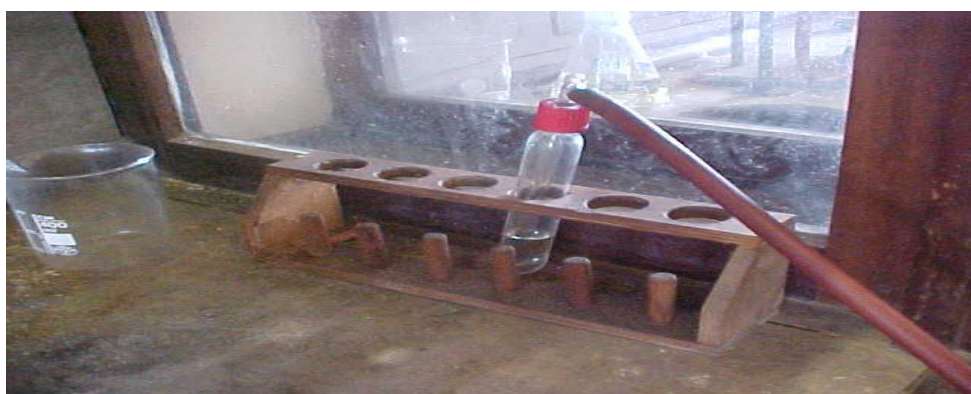

Figure 3.7. Fume chimneys for spraying and flushing.

For example, in Congo red paper, paper is impregnated with Congo red; used as a pH indicator, changing from blue-violet at 3.0 to red at 5.0.

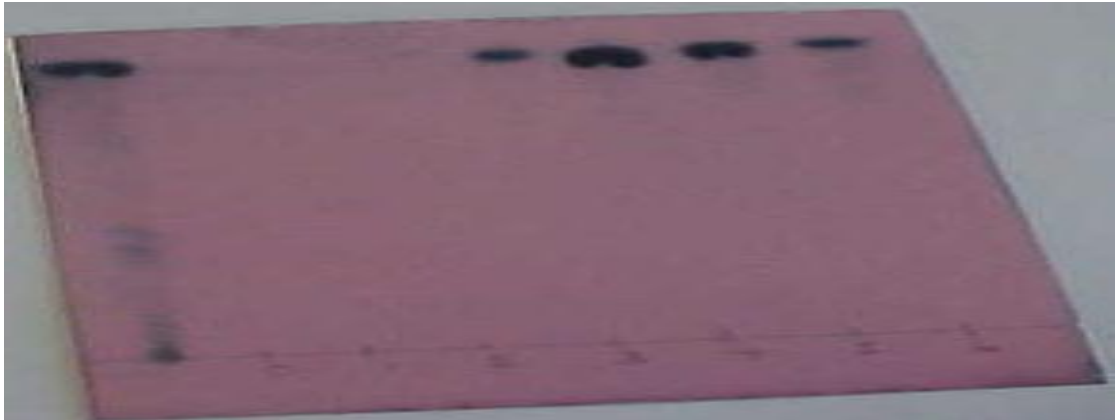

Figure 3.8. Paper chromatograph following spotting, spraying and drying in an oven.



Figure 3.9. Two or three main substances evolve following oven treatment.

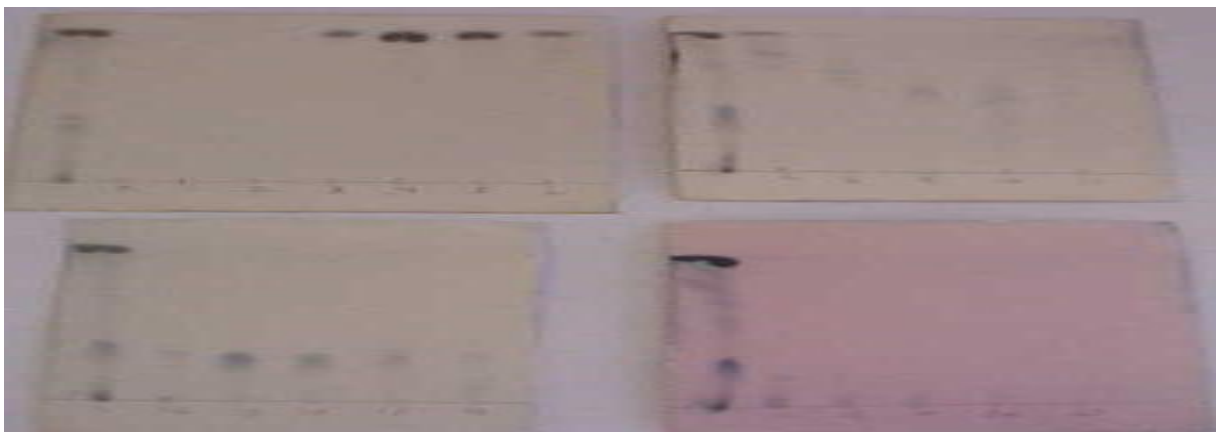

Figure 3.10. Chromatograph papers at the end of each oven drying.

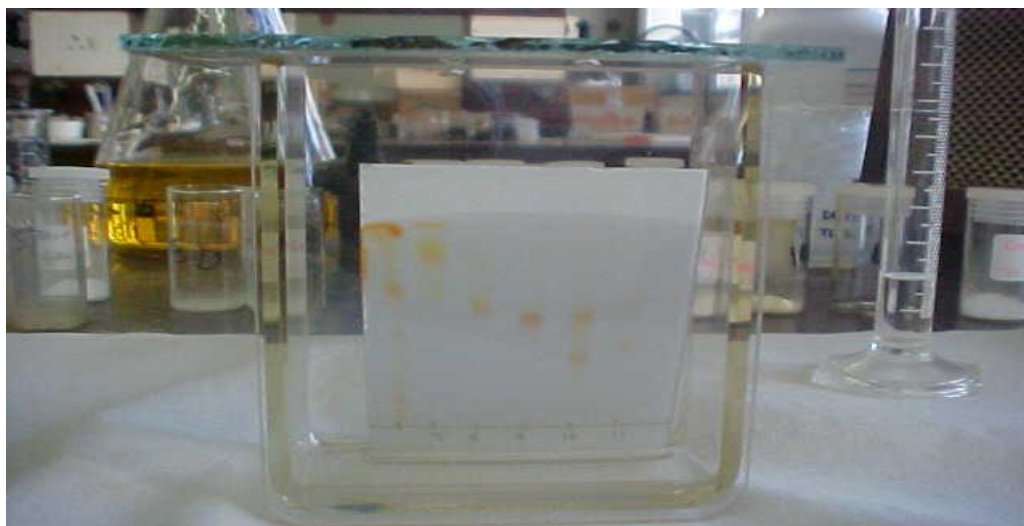

Figure 3.11. Chromatography of pure capsaicin in action.

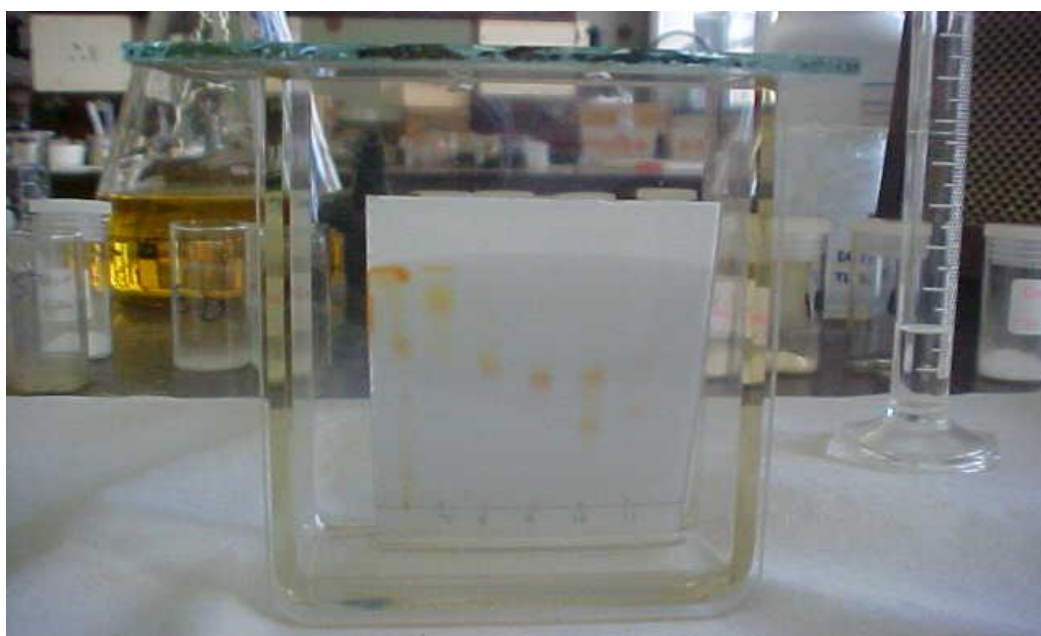

Figure 3.12. Thin layer paper chromatography. Different rate of diffusion was facilitated by capillary action which helps to separate the 3-4 capsaicinoids.

3.4. GAS CHROMATOGRAPHY

In gas chromatography, the substance to be separated into its components is diffused along with a carrier gas through a liquid or solid adsorbent for differential adsorption, [American Heritage Dic. of the English Language, 4th ed.].

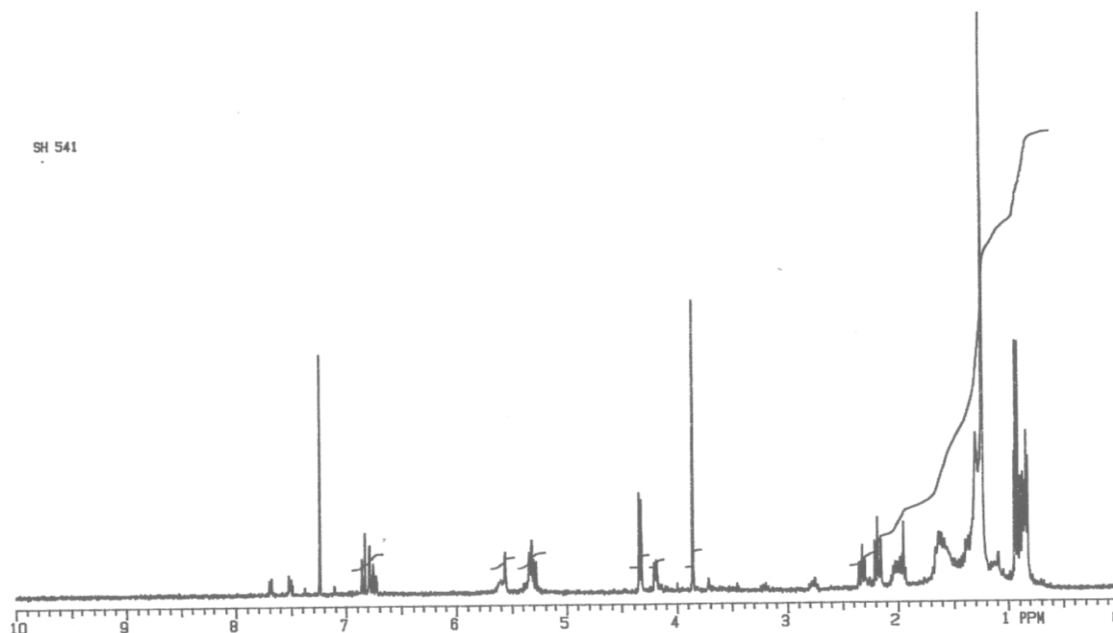

Figure 3.13. NMR profile of capsaicin-courtesy of Prof Shode, Department of Organic Chemistry UKZN/2005

3.5.1. ANALGESIC/NEUROPHARMACOLOGICAL STUDIES

Experiments were performed on male mice (20-30 g body weight). The mice were maintained under conventional laboratory conditions of 12-h light/12-h dark regime, temperature and humidity. The animals were fed with standard diet pellet (Epol-4700, Epol, South Africa) and drinking tap water *ad libitum*. They were kept in the Biomedical Resource Centre, University of KwaZulu- Natal, Durban, South Africa and treated according to best practice in animal experimentation (Jasper and Nelkin, 1992; Midgeley, 1983; Tannenbaum, 1995; Baird and Rosenbaum, 1991). The ‘hot plate’ and ‘acetic acid’ analgesic tests methods were used for central and peripheral nervous system investigations on pain mechanisms, using the mean reaction time and inhibition of writhings, respectively.

3.5.2. ANTI-INFLAMMATORY STUDIES

Healthy, albino rats (250-300 g) of both sexes were used. They were obtained from the Biomedical Resource Unit of the University of KwaZulu-Natal, and were

divided into six groups of 10 rats per group. The animals were kept and maintained under standard laboratory conditions of temperature, humidity, and light. The animals were fed with standard diet pellet (Epol-4700, Epol, South Africa) and drinking tap water *ad libitum* (Baler, 1983; Brink, 2006; Cohen, 1986; Frey, 1987). The circumferences of both hind paws of the rats were measured. They were either pretreated with capsaicin or normal saline. Fresh egg albumin was then injected into the rats' right subplantar hind paws as a phlogistic agent. After 30 mins, the circumferences of the right hind paws of the rats were measured at 30 min, 1, 2, 4, 12 hours respectively. Comparative analysis between the control and treated groups were made, respectively.

3.5.3. EXTRAVASCULAR SMOOTH MUSCLE STUDIES

Healthy, young adult, white albino rabbits of both sexes weighing 1.5–3.0 kg; male and female Dunkin-Hartley guinea pigs weighing 300–450 g; young chicks (aged between 3 and 10 days after hatching), were used. The animals were kept and maintained under standard laboratory conditions of light, temperature, and humidity (Dennis, 1997; Feinberg, 1980; Fox, 1986). The animals were fed with standard diet pellet and drinking tap water *ad libitum*. The effects of *Capsicum*-derived capsaicin on chick isolated parasympathetically-innervated oesophagus, rabbit duodenum, and guinea-pig ileum were investigated in Ugo Basile organ-baths containing Krebs physiological solution maintained at 35⁰ C, respectively. In all cases, concentration-response curves to standard agonists were investigated in the absence and in the presence of capsaicin (CPE), or standard antagonists.

3.5.4. HAEMATOLOGICAL TEST

A pilot study consisting of 12 Witstar rats (250-300 g) treated orally with 50 mg/kg of *Capsicum frutescens* fruit extract was carried out. Tissue morphology was examined grossly from the oesophagus to the intra-abdominal organs.

In the definitive study, Witstar rats weighing 250–300 g were divided into two groups (A and B) of 'control' and 'treated' rats, respectively. All the animals were

fed with standard diet pellet (Epol-4700, Epol, South Africa) and drinking tap water *ad libitum*, unless otherwise indicated (Goodwin, 1992; Goodwin and Morrison, 1993; Hume, 1968). Group A consisted of 12 untreated animals as control, while group B consisted of 3 treatment groups of 12 animals per group and were treated with capsaicin extract (2.5, 5.0, or 10.0 mg/kg i.p.), respectively. Following treatment, 1.5-2 ml blood was collected by cardiac puncture following deep halothane-anaesthesia. The blood specimens were analysed for platelets, as well as the Internationalised Normalised Ratio (INR) of prothrombin. In a parallel study, 3 groups of 12 Witstar rats and 3 groups of 12 rabbits per group were treated with 8 mg/kg of capsaicin extract daily for 2 weeks. Two millilitres of blood was collected from each animal by intracardiac puncture following deep halothane anaesthesia in the rats, and anaket/midazolam anaesthesia in the rabbits. The specimens were analysed for urea and creatinine.

3.6. CARDIOVASCULAR STUDIES

Six rats' hearts were prepared in a 50-ml Laggendorf's Apparatus for each escalated dose of capsaicin, including 0.05, 0.1, 0.2, 0.4, 0.6, 0.8 and 1.0 $\mu\text{g/ml}$ of capsaicin, respectively. The end points measured were changes in the heart rate, coronary perfusion pressure, left ventricular pressures and the left ventricular contractions (dp/dt), using a constantly perfused rat heart in Laggendorf's preparation.

In some preparations, following capsaicin treatments, the hearts were exposed to 30 min ischaemia followed by 60 min reperfusion. The hearts were then treated with 1% triphenyltetrazolium chloride (TTC), an agent that stains cardiac tissues, and allows them to retain their architecture. Histopathological slides of the hearts were prepared and examined for evidence of ischaemia and/or infarction. The results were compared with the controls.

3.7. DATA ANALYSIS

Experimental data obtained were pooled and presented as means (\pm SEM). Data from 'control' rats were used as baseline values. The mean reaction times to the pain stimulus or the writhings were recorded and subsequently analysed using a 2-

way ANOVA. Wilcoxon and Kruskal-Wallis tests were used to assess any differences. Student's t-test was used to test for the difference between the means when two groups were analysed. Where the groups are more than two, ANOVA was used to test for differences between the groups.

Statistical significance was by using a double tailed CI of 95%, and a P value of less than 0.05 (Moore and McCabe, 1993). Pearson correlation coefficient was used to assess the activity of *Capsicum frutescens*-derived capsaicin extract, compared to that of the synthetic capsaicin and to compare results from selected groups.

3.6. REFERENCES

- Baler, A. (1983). Knowing our place in the animal world. In: Miller, H. and Williams, W. (eds). *Ethics and Animals*. Clifton NJ: Humana.: 61-77.
- Baird, R.M. and Rosenbaum, S.E. (eds). (1991). *Animal experimentation: The moral issues*. Buffalo NY: Prometheus Press.
- Brink, H. (2006). *Fundamentals of research methodology for health care professionals* 2nd ed.
- Cohen, C. (1986). The case for the use of animals in biomedical research. *New England Journal of Med* 315: 865-870.
- Dennis, J.U. (1997). Morally relevant differences between animals and human beings justifying the use of animals in biomedical research. *JAVMA* 210: 612-618.
- Feinberg, J. (1980). Human duties and animal rights. *Rights, justice and the grounds of liberty*. Princeton NJ: Princeton University Press. : 185-206.
- Fox, M.A. (1986). *The case for animal experimentation*. Berkeley CA: University of California Press.
- Frey, R.G. (1987). Moral standing, the value of lives and speciesism. *Between Species* 3: 191-201.
- Goodwin, F.K. (1992). Animal rights: Medical research and product testing. *Contemporary Topics in Laboratory Animal Science*; 31: 6-11.
- Goodwin, F.K and Morrison, A.R. (1993). In animal rights debate, the only valid moderates are researchers. *Scientist*; 17: 12.
- Hostetman, K. Marston A. and Wolfender J,-L. (1995) In *Phytochemistry of Plants used in Traditional Medicine* (eds. Hostetman, K. Marston A. Maillard M. and Hamburger M.) Clarendon Press, Oxford;17-45

- Hume, D. (1968). A treatise of human nature. Selby-Bigge, L.A. (ed). Oxford: Clarendon Press.
- Jasper, J.M. and Nelkin, D. (1992). The animal rights crusade: The growth of a moral protest. New York: The Free Press.
- Midgeley, M. (1983). Animals and why they matter. Athens GA: University of Georgia Press.
- Moore, D.S. and McCabe, G.P. (1993). Introduction to the practice of statistics 2nd ed-Freeman & Company New York.
- Parbrook, G.D., Davis P.D., Parbrook, E.O. (1989) Basic Physics and Measurement, Blackwell Scientific Publication.; 102-153.
- Sykes, M., Vickers, M., Hull, C. (1999) Principles of Clinical Measurement in Anaesthesia and Intensive Care Unit, Blackwell Scientific Publication. 3rd Ed.; 167-181
- Tannenbaum, J. (1995). Veterinary Ethics. 2nd ed. St. Louis MO: Mosby Press.
- Wilson, K., Walker, J. (1999) Chromatographic techniques. In: Principles and techniques of practical biochemistry. 4th ed.-Cambridge Univ. Press-Cambridge: 462-529.

CHAPTER 4

Analgesic/Neuropharmacological Effect of capsaicin

Analgesic effects of *Capsicum frutescens* Linn. [Solanaceae] fruit aqueous extract in mice

SUMMARY: The analgesic property of *Capsicum frutescens* LINN. SOLANACEAE] extract-CFE (98% Capsaicin by NMR) of South African origin in mice (20-30 g), using 'hot plate' and 'acetic acid' methods was investigated. In the hot plate test, twelve mice in each of 5 groups were administered intraperitoneal (i.p.) CFE or synthetic capsaicin (Fluka Biotechnika-CF) at 0.5-8 mg/kg and at hourly intervals; at 40 C, the mean reaction time (MRT) was estimated. In the 'acetic acid' test method, CFE or CF was administered i.p. at various doses (0.5- 8 mg/Kg) at hourly intervals following single treatment using 0.2 mls of 3 % v/v acetic acid-induced writhing responses, or non treated (n=12). Separate groups of rats (n=12) were pre-treated with 100-mg/kg diclofenac (DIC) or morphine (MPN) 10 mg/kg i.p. to evaluate the peripheral analgesic effects and central analgesia, respectively. Data obtained were pooled and analysed by the student's T-test. The 'hot plate' and 'acetic acid' test methods showed significant ($p < 0.0001$) prolongation of the MRT and inhibition of writhing responses, respectively, compared to the control. Similar results with a Pearson correlation of 0.999 were obtained in the CF subgroups. This study shows that capsaicin has superior central analgesia compared to equipotency doses of MPN or DIC and comparable peripheral analgesia to either MPN or DIC .

4.1. INTRODUCTION

Chronic pain is a major health hazard resulting in debilitation, sickness role, and adverse drug reactions, including death (Jolayemi, 2002). Pain management is multidisciplinary, with current trend emphasising complimentary health methods (Wallace, 1997;). This multi-specialty approach is unaffordable for patients in developing countries (due to poor socio-economic conditions), resulting in poor compliance, self-medication and high complication rate, or death. A review of the evolution of analgesics shows that they are derived primarily from basic foods, natruceaticals, and other edible or chewable substances, and later from conventional medications. For example, poppy leaf and cannabinoid tea, or chewing of opioids or addictive substances; have been known to certain ethnic groups, for centuries. It is, therefore, important to use these natural interventions in a more scientific and beneficial way to improve compliance and health; and reduce the unwanted side-effects of conventional analgesics. The development of inhibitors of Substance P of plant origin (reviewed by Bevan *et al.*, 1995) provides an opportunity in the treatment of intractable pain.

Capsicum species occur worldwide, and has been used for more than 9000 years by the Chinese, Indians, and Africans for medicinal and non-medicinal purposes (Watt, 1962). One of the main objectives of this study was to determine if *Capsicum frutescens* fruit extract of South African origin, has similar efficacy on peripheral and central components of pain as described for *Capsicum spp* (Linn) [Solanaceae] in other parts of the world, such as India, Mexico, Thailand and South America (Jaiarj *et al.*, 1998).

Studies described in the literature suggest that capsaicin could modulate analgesia (Bevan, 1990; Winter, 1997). Capsaicin extracted from *Capsicum spp* act at the vanilloid receptors to inhibit Substance P, and has proved very useful in intractable pain of diabetic neuropathy, as well as herpetic and trigeminal neuralgia (Davis, 2000). Most of these studies have shown the analgesic effect of capsaicin in spinal mechanism. The questions that remain unanswered include elucidation of central and peripheral analgesic mechanisms of capsaicin. The protection of pre-treated rats

from thermal pain in the ‘hot plate’ test method as described by (Ojewole, 2002) and the percentage inhibition of writhings in the pre-treated rats using the ‘acetic acid’ test method were used in this study.

4.2. ANIMALS

Experiments were performed on mice (20-30 g body weight) of both sexes. The mice were maintained under standard laboratory conditions of light, temperature and relative humidity. The animals were fed with standard diet pellet (Epol-diet 4700, Epol, South Africa) and drinking tap water *ad libitum*. They were kept and maintained in Biomedical Resource Unit, University of KwaZulu-Natal, Durban 4000, South Africa.

4.3.1 DRUGS

Investigative drugs included capsaicin (Fluka-Biotechnika), *Capsicum frutescens*-derived extract, and positive controls (morphine) and diclofenac.

4.3.2. ASSESSMENT OF ANALGESIC EFFECTS OF CAPSAICIN USING THE ‘HOT PLATE’ TEST METHOD

The ‘hot-plate’ (thermal) test method employed in this study was modified from those described in detail earlier by Eddy and Leimback, (1953) cited by Ojewole, (2006); Lanhers *et al.*, (1992); and Williamson *et al.*, (1996) cited by Ojewole, (2006). Mice weighing 20–30 g were divided into two groups (A and B) of control and treated animals. Group A had three subgroups of 12 mice each. The first subgroup consisted of untreated mice, the mice in second and third subgroups were treated with morphine (MPN, 10 mg/kg i.p.) and diclofenac, (DIC 100 mg/kg i.p.), respectively. Group B consisted of 2 main subgroups treated with *Capsicum* fruit aqueous extract (CFE) and CPF as the reference drug. Each subgroup was subdivided into 5 subunits based on the dose regimen of 0.5-8 mg/kg i.p. The animals had similar demographics in terms of sex, age and weight. All the animals

were fed with standard diet pellet and drinking tap water *ad libitum*. A 600-ml glass beaker was placed on a 'Heidolph® MR 2002' hot-plate (with adjustable temperature). The temperature of the hot-plate was then regulated to $40 \pm 1^\circ\text{C}$. Each mouse was placed in the glass beaker (on the hot-plate) in order to obtain the animal's response to electrical heat-induced nociceptive pain (licking of the forepaws and eventually jumping out of the glass beaker). Jumping out of the beaker was taken as an indicator of the animal's response to heat-induced nociceptive pain. The time taken for each mouse to jump out of the beaker (i. e. reaction time) was noted and recorded. Capsaicin extract and CPF were tested at doses of 0.50, 1.0, 2.0, 4, and 8.0 mg/kg i. p., respectively. Treated 'control' mice received MPN (10 mg/kg i. p.), or DIC (100 mg/kg route) only. Due to the effects of gastric juice, capsaicin was administered intraperitoneally, a route that ensures adequate systemic bioavailability, early onset and satisfactory pharmacological activity of the tested agents.

The mean reaction time for each 'test' mouse was determined and documented using a standard stop watch calibrated in seconds. Each mouse served as its own control. Thus, before treatment, its reaction time was determined thrice at 1-hour intervals. The mean of these three determinations constituted the 'initial reaction time'— that is, reaction time before the treatment of the mouse. The mean reaction times for all the mice used were pooled to obtain the final, 'control' mean reaction time (t_1). Each of the mice in the study was thereafter treated with either CFE or CPF. Thirty minutes after treatment with CFE or CPF, the reaction time was again evaluated (t_2). This value was pooled for the mice used in each treatment group, and the final 'test' mean value for each treatment group was calculated. This final 'test' mean value represented 'after-treatment reaction time' for each group of treated mice. This 'test' mean value was subsequently used to determine the percentage thermal pain stimulus relief or protection, by applying the formula:

$$\begin{aligned} \text{\% protection against thermal pain stimulus} &= \text{Test Mean} - \text{Control Mean} \times 100 / \text{Control Mean} \\ &= t_1 - t_2 \times 100 / t_2 \end{aligned}$$

[Where t_1 = the mean 'control' reaction time, and t_2 = mean 'test' reaction time, respectively].

4.3.3. ASSESSMENT OF CFE AND CPF ANALGESIA USING 'ACETIC ACID' TEST METHOD

The 'acetic acid' test method used in this study was adopted from those described earlier by Koster *et al*, (1959); Williamson *et al*, (1996); Zakaria *et al*, (2001); and Silva *et al*, (2003). The mice used were divided into groups of 'test' and 'control' animals. The treated group had subunits that received CFE and CPF, respectively, subdivided into 5 treatment groups of 10 mice each for graded doses of CFE or CPF at 0.5, 1, 2, 4 and 8.0 mg/kg (i.p). Group A control mice included an untreated group of 12 mice and two positive 'control' groups of 10 mice each, that were pre-treated with DIC (100 mg/kg i.p.) and MPN (10 mg/kg i.p.). Each of the untreated 'control', and 'test' animals was treated with intraperitoneally-administered 0.2 ml of 3% v/v acetic acid solution (Koster *et al*, 1959). Twenty minutes after pre-treatment with DIC, a dose of the capsaicin, or the extract, 0.2 ml of a 3% w/v of acetic acid solution was injected intraperitoneally (i. p.) to each of the 'treated' mice (Koster *et al*, 1959).

The number of writhings (i. e., abdominal contractions and stretches) that occurred within the first 20 minutes following acetic acid administration were counted and recorded. The recorded numbers of acetic acid-induced writhings (abdominal contractions and stretches) that occurred in the CFE-, CPF-, and DIC- pretreated mice were compared with those in the 'untreated Group A 'control' mice. This 'test' mean value was subsequently used to determine percentage inhibition to writhing response using the formula:

$$\begin{aligned} \% \text{ inhibition of writhings response} &= \text{Control Mean} - \text{Test Mean} \times 100 / \text{Control Mean} \\ &= w_1 - w_2 \times 100 / w_1 \end{aligned}$$

[Where w_1 = mean 'control' and w_2 = mean 'test' writhing movements, respectively].

4.3.4. DATA ANALYSIS

Data obtained were pooled and presented as means (\pm SEM). Data from 'control' mice were used as baseline values. The mean reaction times to the pain stimulus

were recorded and subsequently analysed using a 2-way ANOVA. Wilcoxon and Kruskal-Wallis tests were used to assess any differences. Statistical significance was obtained by using a double tailed CI of 95%, and a P value of less than 0.05. Pearson correlation coefficient was used to assess the activity of the extract compared to that of the synthetic capsaicin as shown in Tables 4.1-4.3.

4.4. RESULTS

4.4.1. ANALGESIC ACTIVITY

Capsicum frutescens-derived capsaicin extract (0.5–8.0 mg/kg i. p.) produced dose-dependent and significant ($P < 0.05$ – 0.001) analgesic effects against thermally- and chemically-induced nociceptive pain (see Tables 4.1- 4.3). Pretreatment of the mice with either CFE or CPF (0.5–5.0 mg/kg i. p.) caused significant ($P < 0.01$ – 0.0002) delays in the mean reaction times of the animals to thermally-induced pain. (Table 4.1). CFE and CPF (0.5-8.0 mg/kg i.p.) also caused dose-dependent and significant ($P < 0.05$ – 0.001) reductions in the acetic acid-induced writhes of the mice (Table 4.2).

4.4.2. ACTIVITY LEVEL IN MICE

A general observation of the effects of capsaicin on the activities, sleep, pain tolerance and mechano-thermal sensation of mice, were noted. These effects were dose dependent, and wear off with time. The animals' quality of sleep was also better. There were initial excitation following injections of capsaicin, but this was followed by playful acts within each cohort, followed by calmness. These occur for both groups on reference and extracted capsaicin.

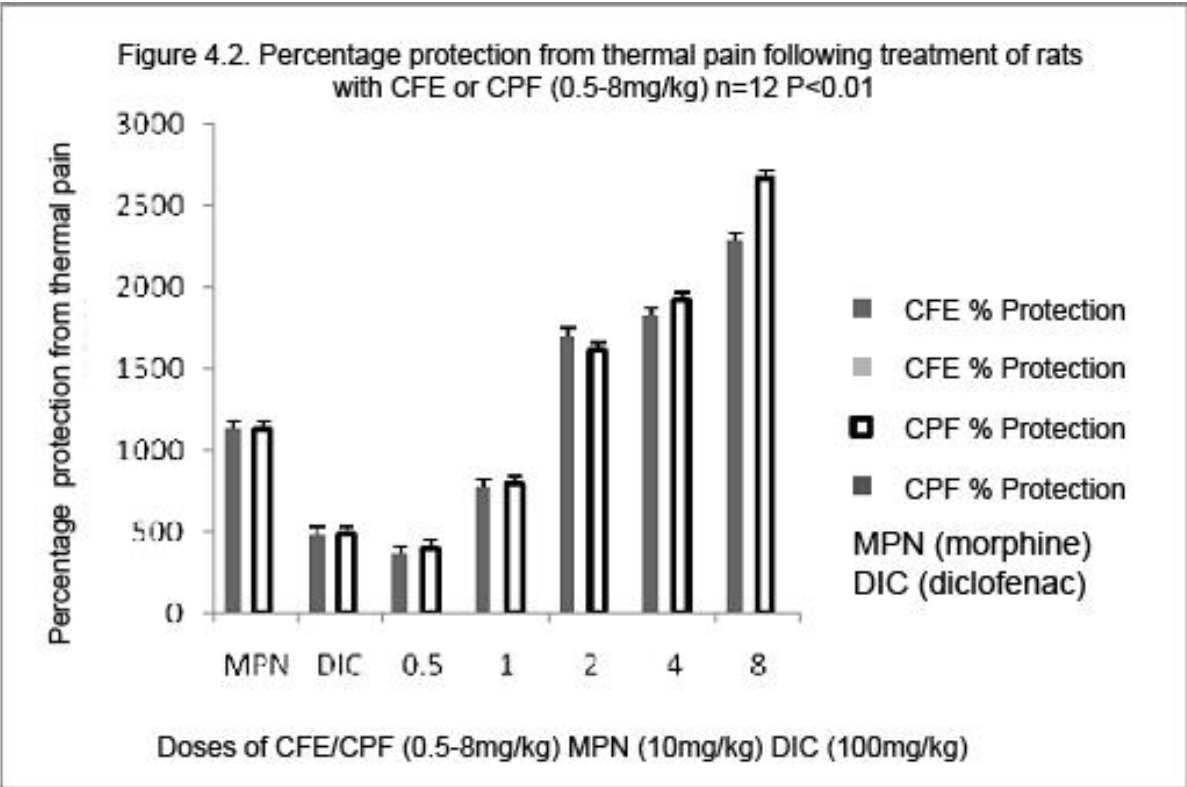
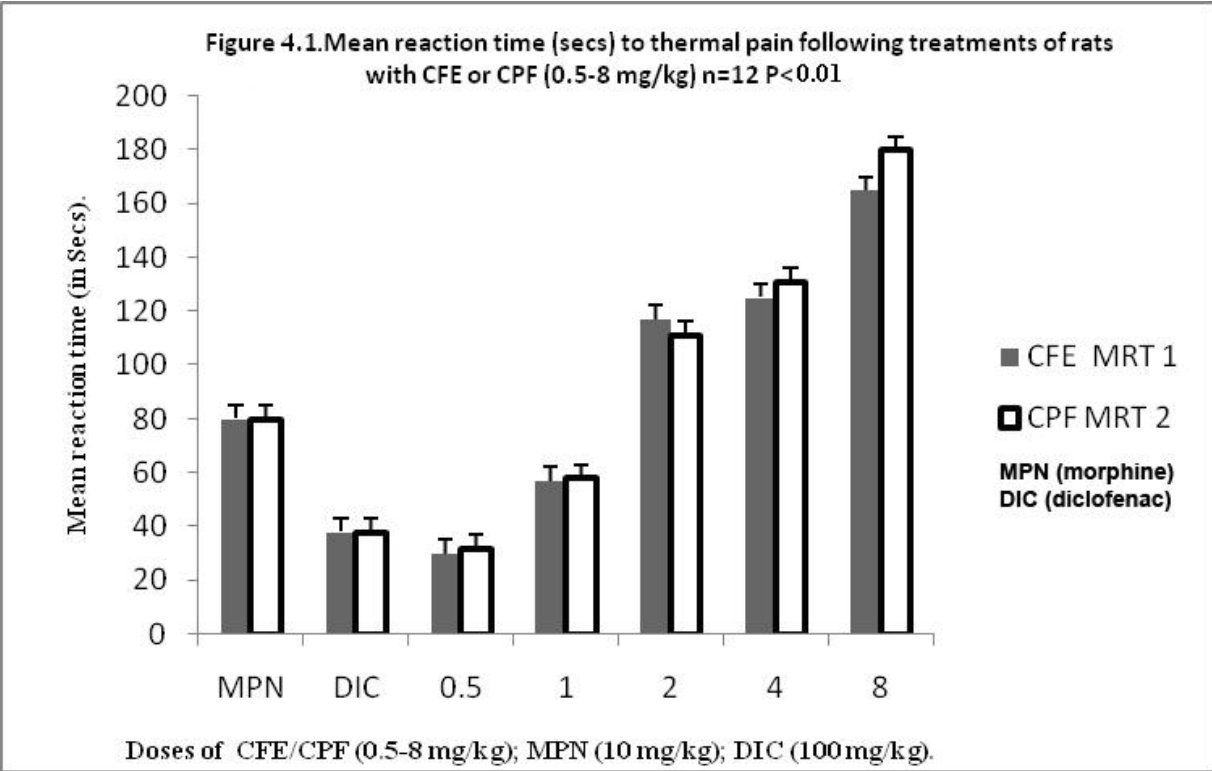

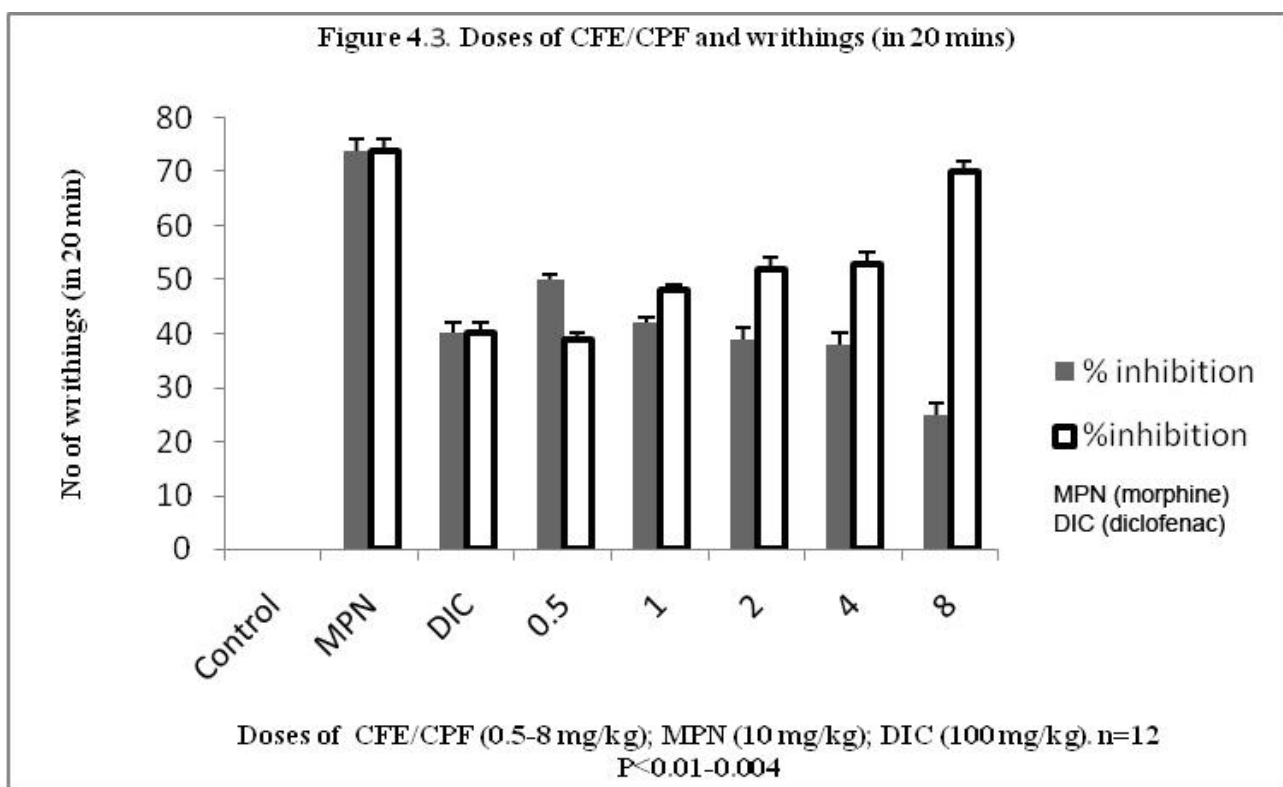

4.5 DISCUSSION

Vanilloid 1 receptor has been described as the molecular integrator of several nociceptive stimuli (Ferreira *et al.*, 2004). Most studies have alluded to the effectiveness of capsaicin-induced central analgesia. The present study aimed to explore the potential benefits of capsaicin in both central and peripheral analgesia.

The use of 'acetic acid' test method to investigate peripheral analgesic mechanism was validated at different times by Koster *et al.*, (1959); Williamson *et al.*, (1996); Zakaria *et al.*, (2001); and Silva *et al.*, (2003). Similarly, the evaluation of central analgesic mechanism using the 'hot plate' test method was validated by Eddy and Leimback, (1953); Lanhers *et al.*, (1992); and Williamson *et al.*, (1996). The reduction in the writhings of the abdominal wall and the prolongation of the mean reaction time to thermal pain can be regarded as indicative of positive peripheral and central analgesic mechanism, respectively.

Centrally acting neuromediators can be classified into excitatory and inhibitory neuromediators. Glutamate and aspartate are examples of excitatory amino acids acting as neurotransmitters centrally. Substance P (SP), calcitonin-gene-related peptide (CGRP) and growth factors (e.g., brain derived neurotrophic factors) are other examples (Cervero, 1983; Chiang, *et al.*, 1997, and 1999). Inhibitory neuromediators include endogenous opioids, such as enkephalin and β -endorphins. Others are gamma aminobutyric acid (GABA), glycine and α -adrenergic agonists. The effects of capsaicin at the GABAergic terminals, central MAO receptors, NMDA, acetylcholine and noradrenergic receptor sites were earlier elucidated (Davis, 1995; Davis, 2000; Woolf, 2000; 2001). The finding suggests that capsaicin activity at vanilloid receptors results in analgesia and cerebral depression at low doses, and that it produces paradoxical effects at other dissimilar receptors at high doses (Davis and Marinelli, 1993; Ralevic, 2001).

The aberration of inflammation and neuropathic enhancement of pain perception as seen in allodynia (painful touch) and hyperalgesia are due to increased release of SP from the *substantia gelatinosa*. This phenomenon is called peripheral sensitization, and three principal neurotransmitters (NMDA, GABA, and Substance P) have been implicated in previous studies. Conversely, any agent acting on these receptors and neuromediators have the ability to modulate pain (Wallace, 1997).

Capsaicin showed a potent analgesic potential in the animals used. The explanation for the statistically often less significant effects at lower doses might have to do with the release of Substance P, due to de-vesiculation mechanism of receptor modification, receptor up-regulation and internalization (Yakish, 1999).

One of the findings of this study is that capsaicin has statistically significant ($P < 0.002$) analgesic effects, especially for chronic therapy on centrally-mediated pain mechanisms. Peripherally-induced analgesia is statistically significant ($P < .001$) as compared to the 'control' at $P < 0.5$. This finding probably suggests that capsaicin inhibits the inflammatory limb of pain mechanisms, or do so by receptor modification, and/or by the 'wind-up' mechanisms shown in previous studies (Winter, 1995).

The present study also shows that capsaicin has dose-dependent and statistically significant analgesic effects on mechano-thermal and chemically-induced pain. These results corroborate earlier studies that capsaicin is efficacious in neuropathic pain from diabetes, herpes, phantom and stump pain, chronic pain from osteoarthritis, and trigeminal neuralgia (Deal, 1991; Dray, 1990; 1992; Dini, 1993; Winter, 1995).

Furthermore, the stimulant effect of capsaicin results in convulsion and death at high doses (Nagy, 1980; 1983; Gade, 1985). Further work will be required to elucidate the mechanisms of this paradoxical effect.

4.6 CONCLUSION

Both capsaicin and *Capsicum frutescens* Linn [Solanaceae] fruit aqueous extract (CFE) have dose-dependent, statistically significant peripheral and central analgesic properties. More studies, however, need to be done towards evolving structural changes in their chemistry so as to develop capsaicin analogues adaptable for human uses in intractable pain from sports injuries, cancer management, and other forms of acute or chronic pain.

4.7. REFERENCES

- Bevan, S. and Szolcsanyi J. (1990). Sensory neuron-specific actions of capsaicin: Mechanisms and applications. *Trends in Pharmacological Sciences*; 11(8):331-333.
- Bevan, S. and Winter J. (1995). Nerve growth factor differentially regulates the chemosensitivities of cultured adult rat dorsal root ganglion neurons. *Journal of Neuroscience*; in press.
- Cervero, F. and McRitchie, H.A. (1983). Effect of neonatal administration of capsaicin in several nociceptive systems of the rat. In: Bonica J.J. Liebeskind, J.C. and Albe-Fessard, D.G. (eds) *Advances in Pain Research and Therapy*. New York: Raven Press; 4:87-94.
- Chiang, C.Y. Hu, J.W. and Sessle, B.J. (1997). NMDA receptor involvement in neuroplastic changes induced by neonatal treatment in trigeminal nociceptive neurons. *Journal of Neurophysiology*; 78(5): 2799-2803.
- Chiang, C.Y. Kwan, C.L. Hu, J.W. and Sessle, B.J. (1999). Effects of GABA receptor antagonist on trigeminal caudalis nociceptive neurons in normal and neonatal capsaicin-treated rats. *American Physiological Society*; 82(5): 2154-2162.
- Coderre, T.J. and Melzack, R. (1991). Central neural mediators of secondary hyperalgesia following heat injury in rats: Neuropeptides and excitatory amino acids. *Neuroscience Letters*; 131: 71-74
- Davis, A. and Perkins, M.N. (1994). The involvement of bradykinin B1 and B2 receptor mechanisms in Substance P-induced mechanical hyperalgesia in the rat. *British Journal of Pharmacology*; 113: Suppl. 26P.

- Davis, A. and Perkins, M.N. (1995). Capsaicin-induced mechanical hyperalgesia in the rat: involvement of NK1, bradykinin B1 and B2 receptors. *British Journal of Pharmacology*; 115: 684-688.
- Davis, J.B. Gray, J. Gunthorpe, M.J. Hatcher, J.P. Davey, P.T. Overend, P. Harries, M.H. Latcham, J. Clapham, C. Atkinson, K. Hughes, S.A. Rance, K. Grau, E. Harper, A.J. Pugh, P.L. Rogers, D.C. Bingham, S. Randall, A. and Sheardown, S.A. (2000). Vanilloid receptor-1 is essential for inflammatory thermal hyperalgesia. *Nature*; 405 (6783): 183-187.
- Dini, D. Bertelli, G. Gozza, A. and Forno, G.G. (1993). Treatment of postmastectomy pain syndrome with topical capsaicin. *Pain*; 54: 223-226.
- Ferreira, J., da Silva, G.L., Calixto, J.B. (2004) Contribution of vanilloid receptors to the overt nociception induced by B2 kini receptor activation. *British Journal of Pharmacology*; 141:787-797.
- Jaiarj, P. Saichompoo, S. Wongkrajang, Y. Vongswan, N. Peungvicha, P. and Jiratchariyakul, W. (1998). Cardiovascular actions of capsaicinoids extract from Thai Capsicum. *Thai Journal of Phytopharmacy*; 5(2): 1-13.
- Jolayemi, A .T. (2002). Adverse drug reactions to pain medications in attendants of Frank Martin pain clinic, Addington Hospital. 1995-2001. *Regional Anaesthesia and Pain Medicine*; 35 (5): S76-76.
- Koster, R.M. Anderson J. and De Beer, E. J. (1959). Acetic acid for analgesic screening. *Federation Proceedings*; 18: 412-418.
- Lanthers, M.C. Fleurentin, J. Dorfman, P. Mortier, F. Vinche, A. and Younos, C. (1992). Anti-inflammatory and analgesic effects of aqueous extract of harpagophytum procumbens. *Planta Medica*; 58 (2): 117-123.
- Marinelli, S. Di Marzo, V. Berretta, N. Matias, I. Maccarrone, M. Bernardi, G. and Mercuri, N.B. (2003). Presynaptic facilitation of glutaminergic synapses

to dopaminergic neurons of the rat substantia nigra by endogenous stimulation of vanilloid receptors. *Journal of Neuroscience*; 23: 3136-3144.

Nagy, J.I. Vincent, S.R. Staines, W.A. Fibiger, H.C. Reisner, T. P. and Yamamura, H. I. (1980). Neurotoxic action of capsaicin on spinal Substance P neurons. *Brain Research*; 186 (2): 435-444.

Nagy, J.I. and van der Kooy, D. (1983). Effects of neonatal Capsaicin treatment on nociceptive thresholds in the rat. *Journal of Neuroscience*; 3: 1145-1150.

Nagy, J.I. (1985). Capsaicin action on the nervous system. In: *Neurotransmitters in action* (Bousfield D). Elsevier Biomedical Press-Amsterdam Trends in Neurosciences; 180-187.

Ojewole, J. A., (2002). Anti-inflammatory properties of *Hypoxis hemerocallidea* corm ('African potato') extracts in rats. *Experimental Clinical Pharmacology*; 24 (10): 685-687.

Ralevic, V. Kendall, D.A. Jerman, J.C. Middlemiss, D.N. and Smart, D. (2001). Cannabinoid activation of recombinant and endogenous vanilloid receptors. *European Journal of Pharmacology*; 424 (3): 211-219.

Silvia, J. Abebe, W. Sousa, S.M. Duarte, V. G. Machado, M.I.L. and Matos, F.J.A. (2003). Analgesic and anti-inflammatory effects of essential oils of eucalyptus. *Journal of Ethnopharmacology*; 89 (2-3); 277-283.

Wallace, M.S. (1997). Advances in pain research. *Anaesthesiology Clinics of North America*.; 15(2): 229-234.

Watt, J.M. and Breyer-Brandwijk, M .G. (1962). The medicinal and poisonous plants of Southern and East Africa: 862-942.

- Winter, J. Bevan, S. and Campbell, E.A. (1995). Capsaicin and pain mechanisms. *British Journal of Anaesthesia* 75: 157-168.
- Woolf, C.J. and Max, M.B. (2001). Mechanism-based pain diagnosis: Issues for analgesic drug development. *Anaesthesiology* (in press)
- Yakish, T.L. (1999). Spinal systems and pain processing: Development of novel analgesic drugs with mechanistically defined models. *Trends in Pharmacological Sciences*; 20: 329-337.
- Zakaria, M. N. M. Islam, M. W. Radhakrishnan, R. Chen, H. B. Kamil, M. Al-Gifri, A. N. Chan, K. and Al-Attas, A. (2001). Antinociceptive and anti-inflammatory properties of *caralluma arabica*. *Journal of Ethnopharmacology*; 76 (2): 155-158.

CHAPTER 5

Anti-inflammatory effect of *Capsicum frutescens* Linn. [Solanaceae] aqueous fruit extract in rats

SUMMARY: The present study investigated the anti-inflammatory property of *Capsicum frutescens* Linn. [Solanaceae] fruit aqueous extract (CFE) in rats. In this study, inflammation was induced in the rats' hind paw following sub-plantar injections of 0.5 ml/kg fresh egg albumin. Sixty rats (250-300 g) were divided into 4 groups. Group A was the 'control' (10 ml/kg of 0.9 % saline i.p.) and group B consisted of 10 rats that received diclofenac (DIC, 100 mg i.p) as the positive 'control'. The circumferences of the rats' paws were repeatedly measured at time intervals of ½, 1, 2, 4, and 8 hours, respectively. Data obtained were pooled and analysed using repeated ANOVA, in a general linear model with the CPSS software. Compared to the diclofenac (DIC) group, the degree of inhibition of paw oedema by CFE and CPF was statistically significant ($P < 0.05 > 0.001$), best in the first 4 hours of treatment.

5.1. INTRODUCTION

Current anti-inflammatory agents have unacceptable systemic side-effects. With the withdrawal of COX-2 agents such as rofecoxib (Vioxx) (Mandell, 2005; Giaquinta, 2004; Nelson *et al.*, 2004); bextra, (Scheen, 2004); and the recommendation for a strong warning on labels of celecoxib and other remaining COX-2 agents (FDA, 2005); it is evident that natreaceuticals and phytochemicals will be sought after as alternative anti-inflammatory and analgesic agents. Prostaglandin inhibitors inhibit cyclo-oxygenase enzymes; leukotriene formation and pyrogen release (Capone *et al.*, 2003). This makes their use to compromise gastric mucosal integrity and renal blood flow, resulting in peptic ulcer, upper gastro-intestinal tract (GIT) bleeding, as well as renal failure.

Current research reports have shown that capsaicin exhibits various potent biological activities following oral or topical administration. These include initial hyperalgesia, analgesia, dyspepsia, anti-inflammatory, anti-pyretic and anti-coagulatory activities. Capsaicin can modulate endocrine and paracrine activities, immune responses, as well as gastro-intestinal and cardiovascular functions. Chronic inflammatory conditions were found to be associated with an up-regulation of Substance P receptors (De *et al.*, 1990; Velazquez *et al.*, 2002). Stimulation of transient receptor potential vanilloid 1 results in the activation of nociceptive and neurogenic inflammatory responses (Rigoni *et al.*, 2003).

Capsaicin has proved very useful in intractable pain of inflammatory origin, such as from osteoarthritis, pruritus, psoriasis, rheumatism, and Complex Regional Pain Syndrome (Winter *et al.*, 1995; Woolf, 1998; Yakish 1999; Yoshimura *et al.*, 2000). Although *Capsicum frutescens* is traditionally used for the treatment of ‘fever’ (inflammation), the mechanism of its action is not well known.

One of the main objectives of this study was to examine if capsaicin of South African origin has any anti-inflammatory action. The use of carrageenin-induced paw oedema to investigate anti-inflammatory properties of pharmacological substances has been reviewed by Winter *et al.*, (1962) and cited by Winter *et al.* (1995). The increase in paw size following injection of carrageenin, or egg albumin as a proinflammatory agent, is regarded as indicative of inflammation (Ojewole, 2002; 2004; Saidu *et al.*, 2000). The degree of inflammation is the difference between the initial paw size and the paw size at a chosen time interval. The percentage inflammation is thereafter calculated. The serum C - reactive protein (CRP) level was used to validate the extent of the inflammation produced by fresh egg albumin.

5.2. MATERIALS AND METHODS

5.2.1. FRESH EGG ALBUMIN-INDUCED PAW OEDEMA IN RATS

Adult rats of both sexes weighing 250-300 g were randomly selected into 4 groups (A-D) of 10 rats per group. Baseline measurements of the circumferences of both the right and left hind limbs were obtained.

Each rat in the control Group A received 10 ml/kg i.p. of normal saline, while each rat in Group B received 100 mg/kg diclofenac (i.p.), respectively. Groups C and D rats received 2.5 mg/kg CFE and CPF, respectively. Each of the 40 rats was then subjected to inflammation by injecting fresh egg albumin (0.5 ml/kg) into the sub-plantar of the right paw according to standard protocol. Thereafter, the circumferences of the paws were repeatedly measured at time intervals of 30 min, 1, 2, 4, and 8 hours, respectively.

5.2.2. BIOCHEMICAL MARKERS OF INFLAMMATION

Blood levels of leucocytes, C-reactive protein and cortisol were measured following prolong exposure to both forms of capsaicin and the phlogistic agent by intracardiac puncture under intravenous anaesthesia with midazolam ('hypnoval').

5.3. RESULTS

5.3.1. FRESH EGG ALBUMIN-INDUCED PAW OEDEMA

Sub-plantar injections of fresh egg albumin (0.5 ml/kg) produced profound and time-related oedema in the rat hind paw of the 'control' rats. Plantar swelling and/or oedema (which became evident approximately 20-30 minutes following fresh egg albumin administration) reached its peak approximately 90 minutes after the sub-plantar injection of fresh egg albumin. Diclofenac (DIC, 100 mg/kg) and reference

capsaicin (CPF) significantly inhibited paw swelling at ($P < 0.05-0.001$) (CI 95%) compared to saline-treated 'controls'.

Table 5.1. Comparative degree of anti-inflammatory effects of capsaicin in rats treated with phlogistic agent compared with parallel groups treated with diclofenac and saline at the same successive time intervals.

GROUPS	Saline	Albumin *	Alb. + CFE**	Alb.+DIC***	Alb. + CPF***
%CO/Ct1	94 ± 1	96 ± 1	88 ± 1	86 ± 1	93 ± 1
%CO/Ct2	97 ± 1	96 ± 1	85 ± 1	83 ± 1	85 ± 1
%CO/Ct3	100 ± 1	103 ± 1	83 ± 1	80 ± 1	81 ± 1
%CO/Ct4	100 ± 2	103 ± 1	97 ± 2	95 ± 1	85 ± 1
%CO/Ct5	102 ± 2	103 ± 2	98 ± 2	96 ± 1	95 ± 1

* $P < 0.02$ ** $P < 0.001$ *** $P < 0.0001$ using repeated ANOVA

(Where C0= initial paw circumference; C1= paw circumference at 30 min; C2=paw circumference at 1 hr; C3= paw circumference at 2 hours; C4= paw circumference at 4 hours; C5= paw circumference at 8).

Table 5.2. Comparative degree of anti-inflammatory effects of capsaicin in rats treated with diclofenac and saline.

GROUPS	Saline	Albumin*	Alb. + CFE**	Alb.+DIC***	Alb. + CPF***
%CO-Ct/C01	-4.1	-0.86	-12.43	-11	-16
%CO-Ct/C02	-1.98	-0.04	-0.97	-0.6	-21
%CO-Ct/C03	2.8	0	0.42	-24	-28
%CO-Ct/C04	3.6	1.43	0.23	-11	-8
%CO-Ct/C05	3.7	4.31	2.5	-5	-4

** $P < 0.001$. *** $P < 0.0001$. (Using repeated ANOVA at 95% CI)

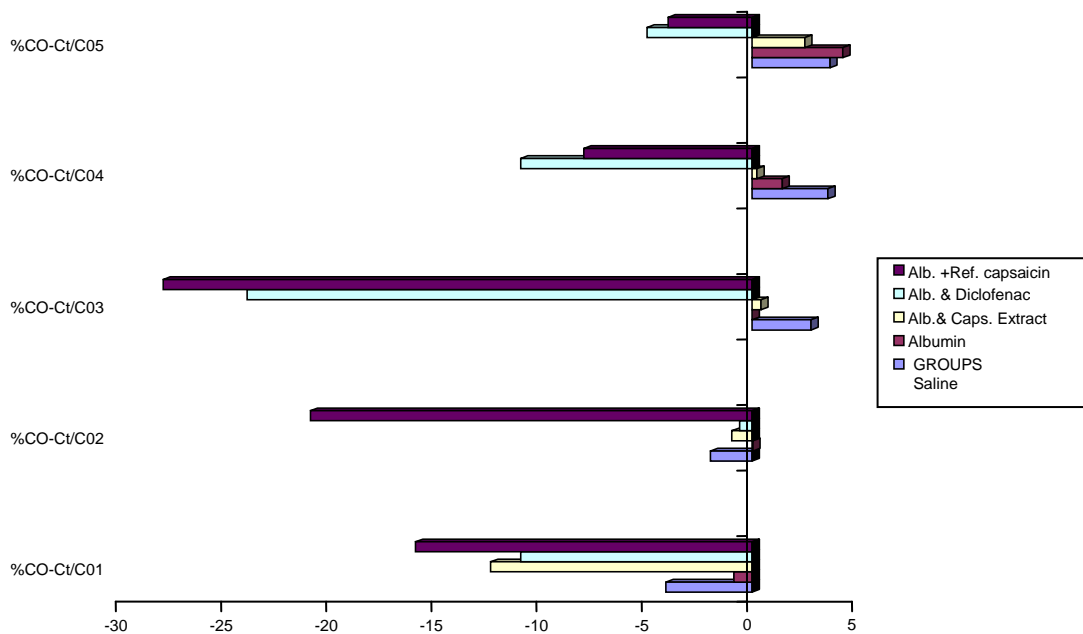

Figure 5.1. Degree of inhibition at 95% CI

5.3.2. CAPSAICIN AND CHEMICAL MARKERS OF INFLAMMATION

Corticosterone levels were all very low (28-31 $\mu\text{mol/L}$) in 7 rats treated with capsaicin. Leucocytes count was within normal range ($2.8-11.8 \times 10^6/\text{L}$) in 11 rats due to the innate immunity of the animals, and their intact defence mechanisms. In 16 specimens randomly assigned for CRP levels, there were very high readings, up to a magnitude of 10 times the normal (3-33 $\mu\text{mol/L}$).

Table 5.3. C-reactive protein (CRP) levels.

	CRP um/L	Gp A	% increase CRP	Gp B	% increase CRP	Gp C	% increas e CRP	Gp D	% increas e CRP
Control	2.5± .2		0		0		0		0
Rats		15±1	500±46	15±1	512±50		0		0

5.4. DISCUSSION

The association of vanilloid receptors with inflammation and pain has been reviewed (Winter *et al*, 1995). It has been established that inflammation is a final pathway in chronic pain, connective tissue diseases, and various systemic disorders. With increase in the levels of Substance P in inflammatory and neurogenic joint diseases (arthritis), topical or intra-articular injections of capsaicin have shown a significant improvement, as well as reduction in the level of inflammatory mediators (Winter *et al*, 1995; Woolf, 1998; Yakish, 1999; Yoshimura *et al*, 2000).

Perkins and Campbell (1992) used 6 mg/kg of intra-articular capsaicin to reverse mechanical hyperalgesia for several hours. In rheumatoid arthritis, the findings are mixed. While Deal and co-workers (1991) showed significant reduction in the level of pain intensity in 31 patients with rheumatoid arthritis of the knee following treatment with Zostrix as 0.025% for 4 weeks, McCarthy and McCarty (1992; 1994) did not observe improvement in 7 patients with rheumatoid hands using 0.75% capsaicin. However, Menkes *et al*. (1993) reported that application of capsaicin (0.75%) for 6 weeks produced a reduction in inflammatory mediators, including Substance P, in the synovial fluid of patients with rheumatoid arthritis.

In osteoarthritis, there is evidence to show an increase in the level of Substance P in patients (Marshall, 1990; Mapp, 1994). Furthermore, randomized, controlled trials have shown significant improvements in pain relief following treatment with capsaicin cream. In addition, a double blind trial (Ellis, 1993) showed that capsaicin is useful in psoriasis. Post-operative use of capsaicin to prevent upper airway

obstruction following Ear, Nose and Throat surgery was recently reviewed (Sicuteri 1989; Kowalski, 1999).

Studies in humans have shown that pain of inflammatory origin, such as neuropathic pain (Wallace, 1997); post-herpetic neuralgia (Berring, 1990; Kurkccuoglu, 1990; Lee, 1994; Leis *et al* 2003); complex regional pain syndrome type I (Sicuteri, 1989); trigeminal neuralgia (Fusco, 1991); oral neuropathic pain (Epstein, 1994); cluster headache (Santiciolli, 1987; Maggi, 1988); fibromyalgia (Marks, 1993), in acute or chronic conditions, such as osteoarthritis (McCarty, 1994) and rheumatoid arthritis (Deal, 1991), have been managed successfully with capsaicin.

In addition, capsaicin has been shown to relieve pruritus in patients with psoriasis (Ellis, 1993); brachioradial pruritus (Goodless and Eaglstein, 1993); aquagenic pruritus (Goodless and Eaglstein, 1993); notalgia parasthetica, nodular prurigo, and pruritus produced in patients on haemodialysis (Brand, 1987). In human volunteers, capsaicin treatment inhibited itch after histamine and allergen challenge. Itching is mediated by a subset of capsaicin-sensitive nociceptive neurons. Blockade of C-fibre conduction suppresses itching (Lou, 1992).

Although several studies have alluded to the usefulness of capsaicin in the above clinical scenarios, these studies lack statistical or clinical significance. Neither was capsaicin compared with placebo or positive controls. In the present study, capsaicin was compared to placebo (negative 'control' saline), and positive controls (diclofenac and morphine) respectively.

Statistical significance was found in animals that received diclofenac, CPF and CFE, compared to animals in albumin and saline alone groups, respectively. Diclofenac, CFE and synthetic capsaicin groups showed significant inhibition of inflammation. With regard to the biochemical inflammatory markers, the high CRP levels showed that the phlogistic agent induced inflammation in rats. The only plausible explanation for the low cortisol levels in all the randomly-sampled animals is that CFE and CPF inhibited the unnecessary stress responses, while not inhibiting the beneficial pro-inflammatory activities to defend the body from infection. This

hypothesis tends to suggest that capsaicin could play a useful role in stress reduction and inflammation.

5.5. CONCLUSION

This study shows that capsaicin possesses dose-dependent anti-inflammatory effects.

5.7. REFERENCES

- Berring, P. Arendt-Nielsen, I. and Soderberg, U. (1990). Argon lasere induced cutaneous sensory and pain thresholds in post-herpeutic neuralgia. Quantitative modulation by topical capsaicin. *Acta Dermatology Venerology*; 70: 121-125.
- Brand, L.L. Berman, E. Schwen, R. Loomans, M. Janusz, J. Bonne, R. Maddin, C. Gardner, J. LaHamn, T. Farmer, R. Jones, L. Chiaabrande, C. and Fanelli, R. (1987). NE-19950: A novel, orally active anti-inflammatory analgesic. *Drugs in Experimental and Clinical Research*; 13: 259-265.
- Capone, M.L. Tacconelli, S. Sciulli, M.G. and Patrignani, P. (2003). Clinical pharmacology of selective COX-2 inhibitors. *International Journal of Immunopathology and Pharmacology*; (2 Suppl): 49-58.
- Deal, C.L. Schnitzer, T.J. Lipstein, E. Seibold, J.R. Stevens, R.M. Levy, M.D. Albert, D. and Renold, F. (1991). Treatment of arthritis with topical capsaicin: a double-blind trial. *Clinical Therapeutics*; 13: 383-395.
- De, A.K. and Ghosh, J.J. (1990). Inflammatory responses induced by Substance P in rat paw. *Indian Journal of Experimental Biology*; 28(10): 946-948.
- Ellis, C.N. (1993). A double-blind evaluation of topical capsaicin in pruritic psoriasis. *Journal of the American Academy of Dermatology*; 29: 438-442.
- Epstein, J.B. and Marcoe, J.H. (1994). Topical capsaicin for treatment of oral neuropathic pain and trigeminal neuralgia. *Oral Surgery Oral Medicine Oral Pathology*; 77: 135-140.
- Fusco, B.M. Geppetti, P. Fanciullacci, M. and Sicuteri, F. (1991). Local application of capsaicin for the treatment of cluster headache and idiopathic trigeminal neuralgia. *Cephalalgia*; 11: 234-235.

- Giaquinta, D. (2004). Lessons learned after the withdrawal of rofecoxib. *Managed Care Interface*; 17(11):25-26, 46.
- Goodless, D.R. and Eaglstein, W.H. (1993). Brachioradial pruritus: Treatment with topical capsaicin. *Journal of the American Academy of Dermatology*; 29: 783-784.
- Kowalski, M.L. Dietrich-Milobedzi, A. Majkowska-Wojciechowska, B. and Jarzebska, M. (1999). Nasal reactivity to capsaicin in patients with seasonal allergic rhinitis during and after the pollen season. *Allergy*; 54(8): 804-810.
- Kurkccuoglu, N. and Alaybeyi, F. (1990). Topical Capsaicin for psoriasis. *British Journal of Dermatology*; 123: 549-550.
- Lee, J.J. and Gauci, C.A. (1994). Postherpetic neuralgia: Current concepts and management. *British Journal of Hospital Medicine*; 52(11): 565-570.
- Leis, S. Weber, M. Isselmann, A. Schmelz, M. and Birklein, F. (2003). Substance P-induced protein extravasation is bilaterally increased in complex regional pain syndrome. *Experimental Neurology*; 183(1): 197-204.
- Lou, Y.P. Franco-Cereceda, A. and Lundberg, J.M. (1991). Omega-conotoxin inhibits CRGP release and bronchoconstriction evoked by a low concentration of capsaicin. *Acta Physiologica Scandinavica*; 141: 135-136.
- Maggi, C.A. Patacchini, R. Santiciolli, P. Giuliani, S. Delbianco, F. Geppetti, P. and Meli, A. (1988). Protective action of ruthenium red toward capsaicin desensitization of sensory fibers. *Neuroscience Letters*; 88: 201-205.
- Mandell, B.F. (2004). The viox withdrawal: latest in the COX 2 controversies. *Cleveland Clinics Journal of Medicine*; 71(11): 849-852.

- Mapp, P. and Kidd, B. (1994). The role of Substance P in rheumatic disease. *Seminars in Arthritis and Rheumatism*; 23: Suppl 3, 3-9.
- Marks, D.R. Rapoport, A. Padla, D. Weeks, R. Rosum, R. Sheftell, F. and Arrowsmith, F A. (1993). Double-blind placebo-controlled trial of intranasal capsaicin for cluster headache. *Cephalalgia*; 13: 114-116.
- Marshall, K.W. Chiu, B. and Inman, R.D. (1990). Substance P and arthritis: Analysis of plasma and synovial fluid levels. *Arthritis and Rheumatism*; 33: 87-90.
- McCarthy, G.M. and McCarthy, D.J. (1992). Effect of topical capsaicin in the painful osteoarthritis of the hands. *Journal of Rheumatology*; 19: 604-607.
- McCarty, D.J. Csuka, M. McCarthy, G. and Trotter, D. (1994). Treatment of pain due to fibromyalgia with topical capsaicin: A pilot study. *Seminars in Arthritis and Rheumatism*; 23: (Suppl 3) 41-47.
- Menkes, C.J. Renoux, M. Loussadi, S. Mauborgne, A. Bruxelle, J. and Cesselin, J. (1993). Substance P (SP) levels in synovial tissue and synovial fluid from rheumatoid arthritis (RA) and osteoarthritis (OA) patients. *Journal of Rheumatology*; 20: 714-717.
- Nelson, M. and Cicutini, F. (2004) Lessons on prescribing and drug safety from withdrawal of rofecoxib. *Australian Family Physician*; 33(12): 965-966.
- Ojewole, J.A.O. and Adewunmi, C.O. (2004). Anti-inflammatory and hypoglycaemic effects of tetrapleura tetraptera (Taub) [fabaceae] fruit aqueous extract in rats. *Journal of Ethnopharmacology*; 95(2-3): 177-182
- Ojewole, J.A.O. (2007). Analgesic, anti-inflammatory and hypoglycaemic effects of *Rhus chirindensis* (Baker F.) [Anacardiaceae] stem-bark aqueous extract in mice and rats. *Journal of Ethnopharmacology*; 113(2): 338-345.

- Perkins, M.N. and Campbell, E.A. (1992). Capsazepine reversal of the analgesic action of capsaicin in vivo. *British Journal of Pharmacology*; 107: 329: 184-194.
- Rigoni, M. Trevisani, M. Gazzieri, D. Nadaletto, R. Tognetto, M. Cremon, C. Davis, S. Camp, B. Amadesi, S. Geppetti, P. and Harrison, S. (2003). Neurogenic responses mediated by Vanilloid receptor-1 (TRPV1) are blocked by the high affinity antagonist iodo-resiniferatoxin. *British Journal of Pharmacology*, 138:977-985.
- Saidu, K. Onah, J. Orisadipe, A. Olusola, A. Wambebe, C. and Gamaniel K. (2000). Antiplasmodial, analgesic, and anti-inflammatory activities of the aqueous extract of the stem bark of *erythrina senegalensis*. *Journal of Ethnopharmacology*; 71 (1-2): 275-280.
- Santiciolli, P. Patacchini, R. Maggi, C.A. and Meli, A. (1987). Exposure to calcium-free medium protects sensory fibers by capsaicin desensitization. *Neuroscience Letters*; 80: 167-172.
- Scheen, A.J. (2004). Withdrawal of rofecoxib (Vioxx): What about cardiovascular safety of COX-2 selective non-steroidal anti-inflammatory drugs? *Review Medical Liege*; 59(10): 565-9.
- Sicuteri, F. Fusco, B.M. Marabini, S. Caimpagnolo, V. Maggi, C.A. Geppetti, P. and Fanciullaci, M. (1989) Beneficial effect of capsaicin application to the nasal mucosa in cluster headache. *Clinical Journal of Pain*; 5:49-53.
- Velaquez, R.A. McCarson, K.E. Cai, Y. Kovacs, K.J. Shi, Q. Evensjo, M. and Larson, A.A. (2002) Upregulation of neurokinin-1 receptor expression in rat spinal cord by an N-terminal metabolite of Substance P. *European Journal of NeuroSciences.*; 16 (2):229-241.

- Wallace, M.S. (1997). Advances in pain research. *Anaesthesiology Clinics of North America* 15 (2):229-234.
- Winter, J. Bevan, S. and Campbell, E.A. (1995) Capsaicin and pain mechanisms; *British Journal of Anaesthesia* 75: 157-168.
- Yoshimura, M. Yonehara, N. Ito, T. Kawai, Y. and Tamura, T. (2000). Effects of topically applied capsaicin cream on neurogenic inflammation and thermal sensitivity in rats. *Journal of the Peripheral Nervous System*; 82(2): 116-121.
- Yakish, T.L. (1999). Spinal systems and pain processing: Development of novel analgesic drugs with mechanistically defined models. *Trends in Pharmacological Science*; 20:329-337.

CHAPTER 6

Pharmacological effects of capsaicin on gastrointestinal smooth muscles

SUMMARY: The present study investigated the effects of increasing concentrations of capsaicin, acetylcholine and other agonist drugs, with specific antagonists, on strips of chick oesophagus, guinea-pig ileum, and rabbit duodenum. The results of this *in vitro* laboratory animal study indicate that relatively ratio low concentrations of CPF (20-40 µg/ml) produced significant ($p < 0.05$) and concentration-related inhibitions of acetylcholine (0.1-5 µg)-induced contractions of the chick oesophagus, guinea-pig ileum and rabbit duodenum. Biphasic effects which were noticed at lower concentrations (0.1-10 µg/ml) were then followed by longer-lasting relaxations and/or reductions of the contractile amplitudes of the muscle preparations.

6.1. INTRODUCTION

Substance P (SP) and neurokinin A (NKA) are putative neurotransmitters that exert important physiological functions in both the central nervous system and peripheral tissues (Bartho *et al.*, 1985). Renzi *et al.*, (2000) defined the cellular sites of Substance P (NK-1R) and neurokinin A (NK-2R) receptor expressions in healthy and inflamed human intestines by *in situ* hybridization and immunohistochemistry. The investigations observed that they are located in the *muscularis mucosae propria* and *lamina propria*. In inflammatory bowel diseases, such as Crohn's disease and Ulcerative colitis, there is an up-regulation of the NK-1R receptors. Both tachykinins were found to be co-localized in secretory vesicles. They are co-released on application of depolarizing stimuli, and when intestinal motility is reflexly activated (Donnerer *et al.*, 1984).

Receptors for Substance P have seven transmembrane spanning sequences, and are G-protein coupled via the phosphoinositide-signalling pathway (Sasai *et al.*, 1989; Hershy *et al.*, 1990; Takahashi *et al.*, 1992; Nakanishi *et al.*, 1991; Guard *et al.*,

1991). Within the gastro-intestinal tract, SP and NKA are involved in the physiological control of several digestive functions, including motility, fluid and electrolyte secretion, blood flow, and tissue homeostasis (Otsuka, 1993; Holzer *et al.*, 1997). Consistent with this finding, an upsurge of SP in irritable bowel syndrome (IBD) was confirmed by Mantyh *et al.*, (1988). Pretreatment of rats with either capsaicin or NK-1R antagonists dramatically reduced fluid secretion, mucosal permeability, and intestinal inflammation in animal models of acute and chronic inflammation (Castagliuolo *et al.*, 1997; McCafferty *et al.*, 1994; Mantyh *et al.*, 1985; Pothoulakis *et al.*, 1994). On this note, selective antagonists of SP have been developed for experimental treatment of the triad of diarrhoea, pain, and mucosal inflammation.

The primary aim of this study was to investigate the effects of capsaicin on isolated smooth muscles of the chick oesophagus, guinea-pig ileum, and rabbit duodenum. Other objectives included elucidation of the possible mechanisms of action of capsaicin on smooth muscles as reported in the body of literature, and those findings which were not documented as for studies on chick oesophagus, rabbit duodenum and guinea-pig ileum. Furthermore, a part of the objectives was to confirm or refute any commonly-reported adverse effects of capsaicin. For example, gastro-intestinal disturbances through its effects on the locomotor organ of the gastro-intestinal smooth muscles.

6.2. MATERIALS AND METHODS

6.2.1. ANIMALS

Young adult, white albino rabbits of both sexes (1.5-3.0 kg), male and female, young adult Dunkin-Hartley guinea-pigs (300–450 g); and young chicks (aged between 3 and 10 days after hatching (20–40 g) were used. The animals were kept and maintained under standard laboratory conditions of light, temperature, and relative humidity. The animals were fed with standard pellet diet and drinking tap water *ad libitum*.

6.2.2. EFFECTS OF CAPSAICIN ON CHICK SOLATED OESOPHAGUS

Young chicks (aged between 3 and 10 days after hatching) were starved overnight (to empty their crops) and killed by ether inhalation. The upper oesophagus, as far as the crop, was carefully isolated together with as much as possible of the right parasympathetic nerve trunk which runs along the course of the jugular vein. Parasympathetic-innervated oesophageal muscle strips were removed from the chicks according to the method described by Bowman and Everett (1964). In each case, tubular segments (3–4 cm long) of the entire upper oesophagus were removed, set-up, treated and chemically stimulated under physiological conditions as described in detail earlier by Ojewole (1976). Each isolated oesophageal muscle strip was suspended in a 30-ml ‘Ugo Basile Organ-Bath’ containing Krebs-Henseleit physiological solution (of composition, in g/litre: NaCl, 6.92; KCl, 0.34; NaH₂PO₄, 0.15; NaHCO₃, 2.1; MgCl₂, 0.11; CaCl₂, 0.26; and glucose, 1.00). The physiological solution was maintained at 32±1°C and continuously aerated with carbogen (i. e., 5% carbon-dioxide + 95% oxygen gas mixture). Two muscle preparations (one used as ‘control’ and the other one used as CFE or CPF or drug-treated ‘test’ preparation) were always set-up to allow for changes in the oesophageal muscle sensitivity. Each preparation was subjected to a resting tension of 1.0 g, and allowed to equilibrate for 30–45 minutes before it was challenged with CFE or CPF, and other drugs used. Concentrations of CFE or CPF (and other drugs used) were added to the bath-fluid either cumulatively or sequentially (i.e., non-cumulatively), and washed out three-to-five times after the maximum responses of the tissues were attained. Concentrations of bath-applied CFE or CPF (and other drugs used) were repeated where appropriate and/or possible, at regular intervals of 20–30 minutes after the last washing. The electrically-induced contractions, as well as CFE or CPF and other drug-induced responses of the muscle preparations were recorded isometrically by means of Ugo Basile force-displacement transducers and 2-channel “Gemini” pen-writing recorders (model 7070).

6.2.3. EFFECTS OF CAPSAICIN ON GUINEA-PIG ISOLATED ILEUM

Male and female Dunkin-Hartley guinea-pigs (weighing 300–450 g) were used. Each of the animals was killed by deep ether inhalation and bled out. Tubular pieces (3–4 cm long) taken from distal ileum of each animal were suspended in 30-ml ‘Ugo Basile Organ-Baths’ (model 4050) containing Krebs-Henseleit physiological solution maintained at $36\pm 1^{\circ}\text{C}$ and continuously aerated with carbogen (i. e., 5% carbon-dioxide + 95% oxygen gas mixture). Two ileal muscle preparations (one used as ‘control’ and the other one used as capsaicin- or drug-treated ‘test’ preparation) were always set up to allow for changes in the ileal muscle sensitivity. The tissues were subjected to a resting tension of 1.0 g, and allowed to equilibrate for 30–45 minutes before they were challenged with concentrations of CFE or CPF (or other drugs used). Concentrations of capsaicin (and other drugs used) were added to the bath-fluid either cumulatively or sequentially, and washed out three-to-five times after the maximum responses of the tissues were attained. Concentrations of capsaicin (and other drugs used) were repeated where appropriate and/or possible, at regular intervals of 20–30 minutes after the last washing. CFE or CPF - (and other drugs-) induced contractions and responses of the isolated ileal muscle preparations were recorded isometrically by means of Ugo Basile’s force displacement transducers and 2-Channel “Gemini” Recorders (model 7070).

6.2.4. EFFECTS OF CAPSAICIN ON RABBIT ISOLATED DUODENUM

Each rabbit used was killed by deep ether inhalation and bled out. The abdomen of the animal was quickly opened by a midline incision, and tubular pieces (3–4 cm long) of the duodenum were carefully cleaned free of connective, extraneous and fatty tissues, and then removed. The tubular pieces (3–4 cm long) were separately suspended in 30-ml ‘Ugo Basile Organ-Baths’ (model 4050) containing Krebs-Henseleit physiological solution maintained at $36\pm 1^{\circ}\text{C}$ and continuously aerated

with carbogen (i. e., 5% carbon-dioxide + 95% oxygen gas mixture). Two isolated duodenal preparations, one used as 'control' and the other one used as CFE or CPF or drug-treated 'test' preparation were always set-up to allow for changes in the duodenal muscle sensitivity. Each of the isolated duodenal muscle preparations was allowed to equilibrate for a period of 30–45 minutes under an applied resting tension of 1.5 g, before it was challenged with concentrations of CFE or CPF and other drugs used. Concentrations of CFE or CPF and other drugs used were applied to the bath-fluid either cumulatively or sequentially, and washed out three-to-five times after the maximum responses of the tissues were attained. Concentrations of CFE or CPF and other drugs used were repeated where appropriate and/or possible, at regular intervals of 20–30 minutes after the last washing. The amplitude and frequency (rate) of the spontaneous, myogenic, pendular, rhythmic contractions, as well as the CFE or CPF and other drug-induced responses of the isolated muscle strips were recorded isometrically with the aid of Ugo Basile force-displacement transducers and 2-Channel "Gemini" Recorders (model 7070).

6.3. DATA ANALYSIS

Data obtained from 'test' groups of isolated muscle strips (chick oesophagus, guinea-pig ileum, and rabbit duodenum) treated with CFE or CPF and other drugs used, and those obtained from saline-treated 'control' isolated muscle preparations, were pooled, and expressed as means (\pm SEM). The differences between CFE or CPF or drug-treated 'test' means, and saline-treated 'control' means, were analyzed statistically by using 'Student's t-test' (Snedecor and Cochran, 1967) to determine the level of significance of the differences between the 'test' and 'control' group data means. Values of $P \leq 0.05$ were taken to imply statistical significance.

6.4. RESULTS

The results obtained in this set of experiments demonstrated that CFE or CPF possesses an array of pharmacological actions on extra-vascular (i. e., non-vascular) smooth muscles, and confirm the findings of the previous workers.

6.4.1. EFFECTS OF CAPSAICIN ON CHICK ISOLATED

OESOPHAGUS

Relatively low to high concentrations of CFE or CPF (5–160 μg) always produced initial brief rises in the baseline tensions of the the chick oesophageal muscle preparations in a concentration-dependent manner. Furthermore, relatively small to high concentrations of CPE or CPF (5–160 μg) always produced a secondary concentration-related and significant ($P < 0.05$), inhibitions of the chick oesophageal muscle preparations. Figures 6.1 summarize the results obtained. Acetylcholine (ACh)-provoked contractions of the chick oesophageal muscle preparations were concentration-dependently inhibited or abolished by bath-applied atropine (0.1–2.5 $\mu\text{g}/\text{ml}$) similar to 1-2 $\mu\text{g}/\text{ml}$ of CFE or CPF (Figure 6.1).

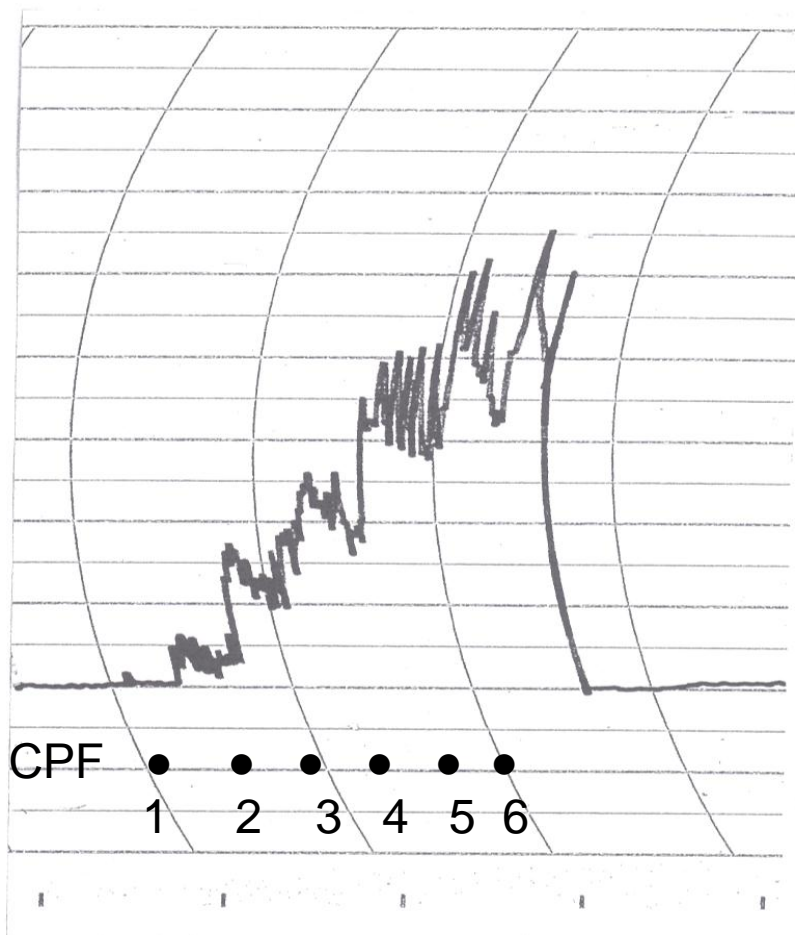

Figure 6.1a. Shows a typical trace obtained following escalated concentrations of CPF on chick oesophagus. CPF 1-6 represents capsaicin 5, 10, 20, 40, 80, and 160 $\mu\text{g}/\text{ml}$, respectively.

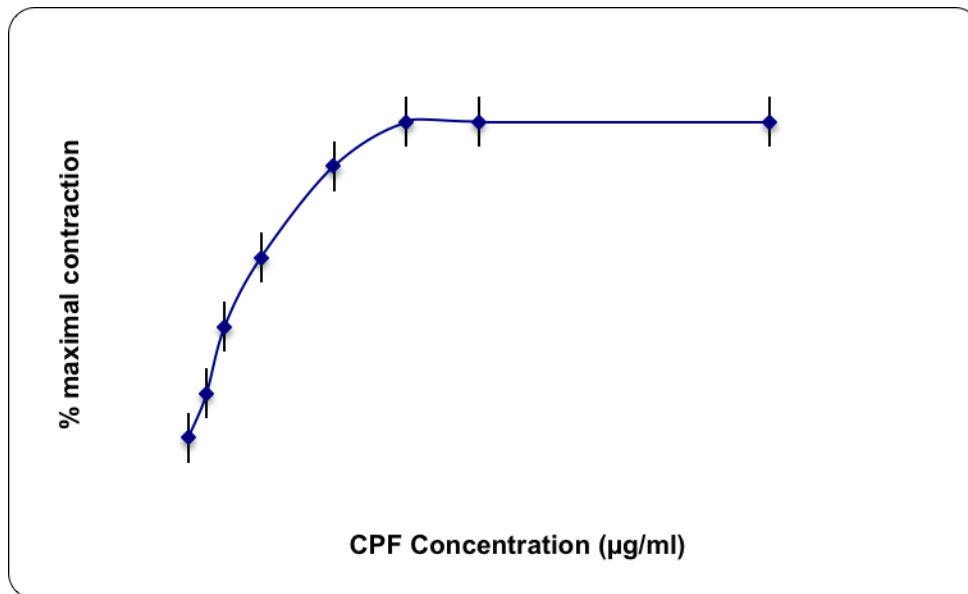

Figure 6.1b. Shows CPF concentration-effect curve following escalated concentrations of CPF on chick oesophagus.

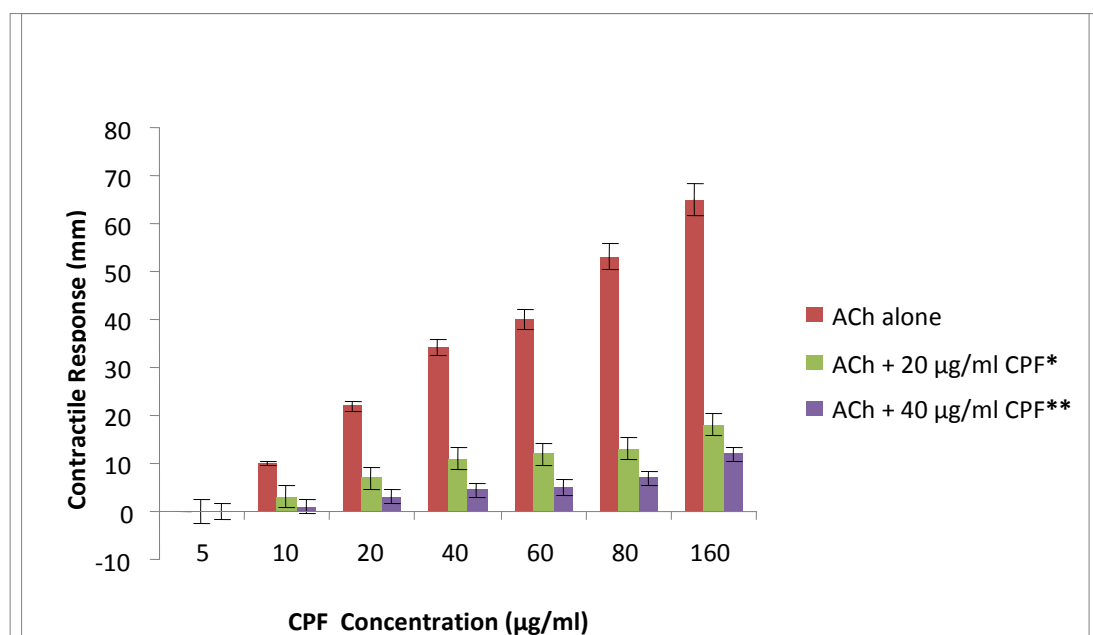

Figure 6.1c. Shows concentration-effect curve to acetylcholine (ACh) in the absence and in the presence of CPF (20 µg/ml and 40 µg/ml, respectively) on the chick oesophagus. * $P < 0.05$ ** $P < 0.01$.

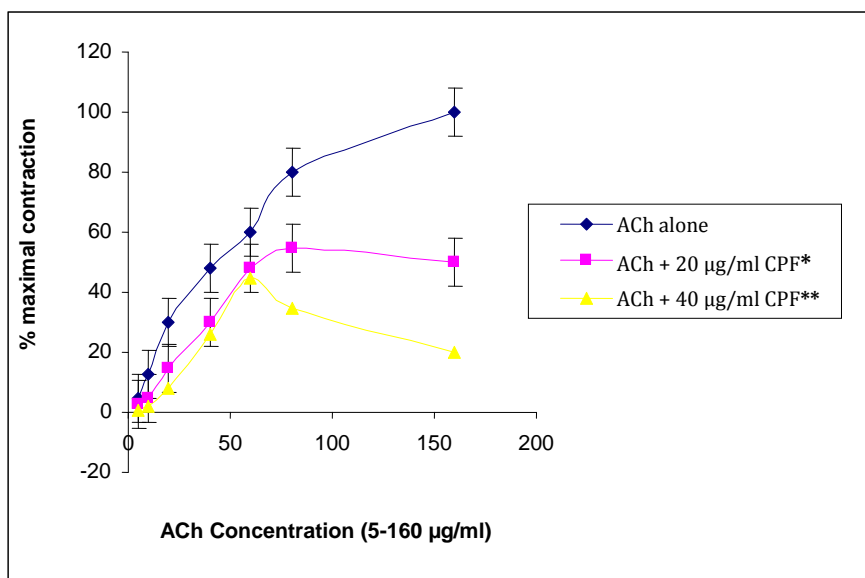

Figure 6.1d. Shows concentration-effect curves to acetylcholine (ACh) in the absence, and in the presence, of CPF (20 µg/ml and 40 µg/ml respectively) on the chick oesophagus. * P< 0.05 ** P< 0.01.

6.4.2. EFFECTS OF CAPSAICIN ON GUINEA-PIG ISOLATED ILEUM

In the guinea-pig isolated ileal muscle preparations, the pharmacological effects of relatively low to high concentrations of CFE or CPF (5–160 µg/ml) were found to be similar to those produced by the plant's extract in the chick-isolated oesophageal muscle preparations. However, relatively low to high concentrations of CFE or CPF 10–160 µg/ml always raised the baseline tension (baseline tone) of, and contracted the guinea-pig isolated ileal muscle preparations in a concentration-dependent manner. Acetylcholine (ACh, 0.1–2.5 µg/ml), and carbachol (1.0–10.0 µg/ml), also contracted guinea-pig isolated ileum in a concentration-related manner. Relatively low to high concentrations of CFE or CPF (10–160 µg) potentiated acetylcholine-(ACh, 0.1–1.0 µg/ml)-induced contractions of guinea-pig isolated ileum in a concentration-related manner. Like acetylcholine and carbachol-provoked contractions of the guinea-pig ileal muscle preparations, CFE or CPF contractions of the guinea-pig isolated ileal muscle preparations were also concentration-dependently inhibited or abolished by bath-applied atropine (0.1–2.5 µg/ml). (Figures 6.2).

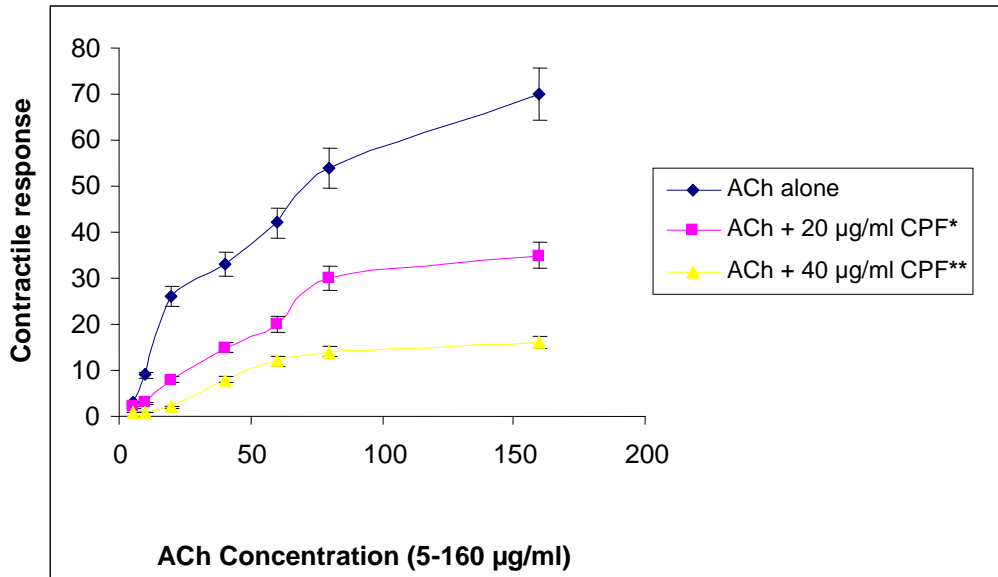

Figure 6.2a. Shows concentration-effect curves to acetylcholine (ACh) in the absence, and in the presence, of CPF (20 µg/ml and 40 µg/ml respectively) on isolated guinea-pig ileum. * P< 0.05 ** P< 0.01

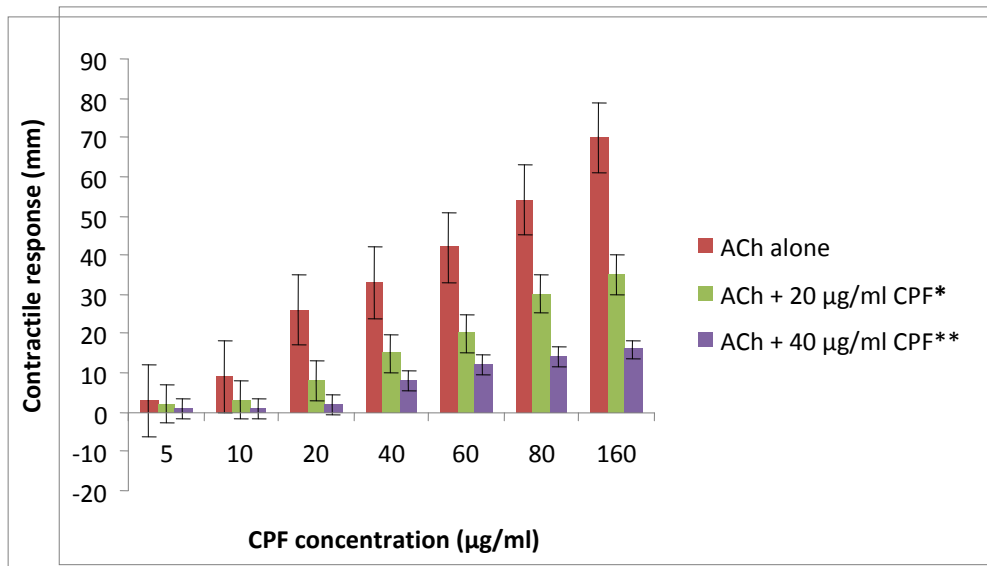

Figure 6.2b. Shows concentration-effect curves to acetylcholine (ACh) in the absence, and in the presence, of CPF (20 µg/ml and 40 µg/ml respectively) on isolated guinea-pig ileum. * P< 0.05 ** P< 0.01

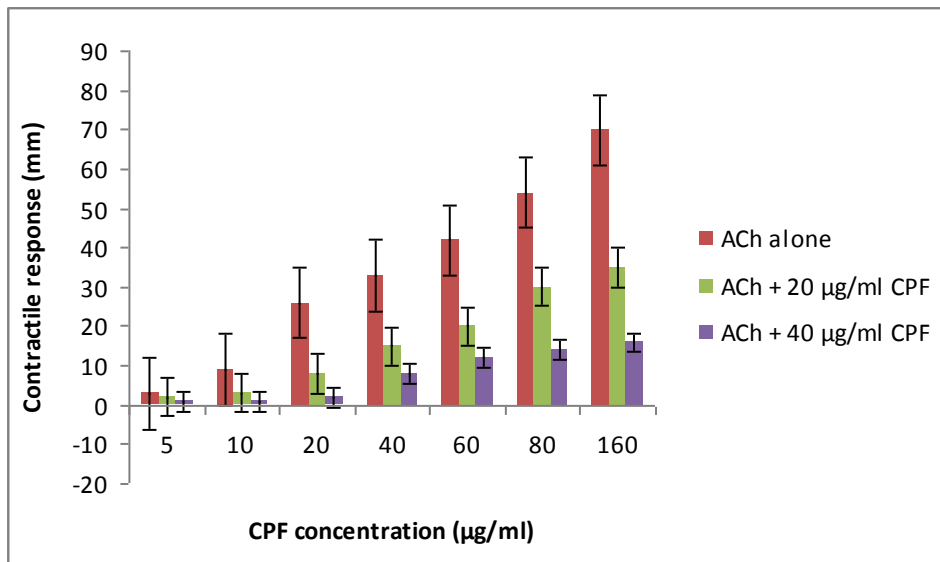

Figure 6.2b. Shows concentration-effect curves to acetylcholine (ACh) in the absence, and in the presence, of CPF (20 µg/ml and 40 µg/ml respectively) on isolated guinea-pig ileum.

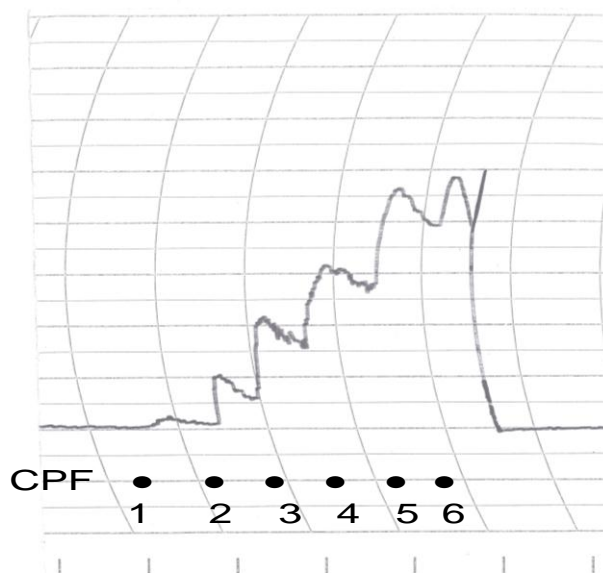

Figure 6.3. Shows a typical trace obtained following escalated concentrations of CPF on isolated guinea-pig ileum. CPF 1-5 represents capsaicin 5, 10, 20, 40, 80, and 160 $\mu\text{g}/\text{ml}$, respectively.

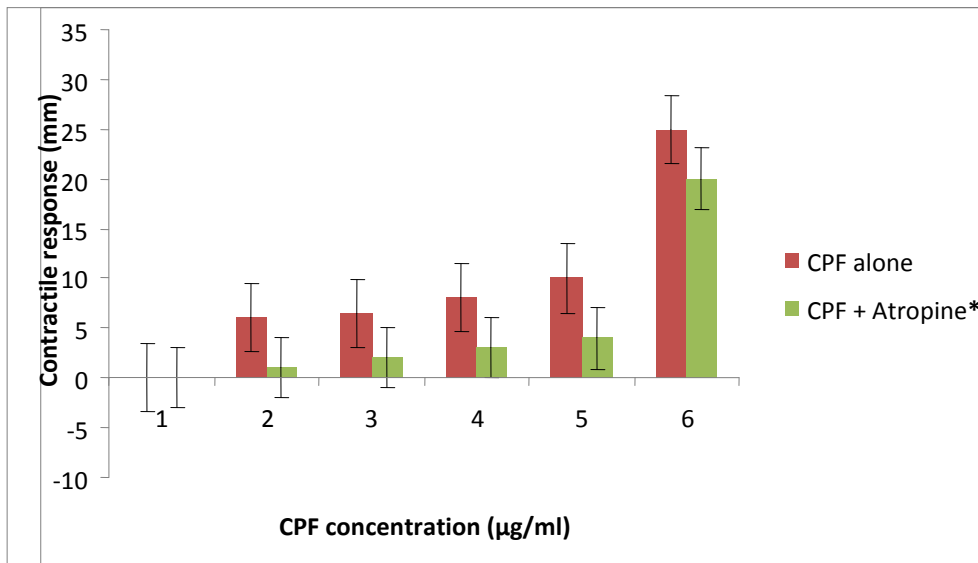

Figure 6.4. Shows concentration-effect curve to capsaicin (CPF) in the absence, and in the presence, of 20 $\mu\text{g}/\text{ml}$ atropine (ATR) on isolated guinea-pig ileum. * $P < 0.05$

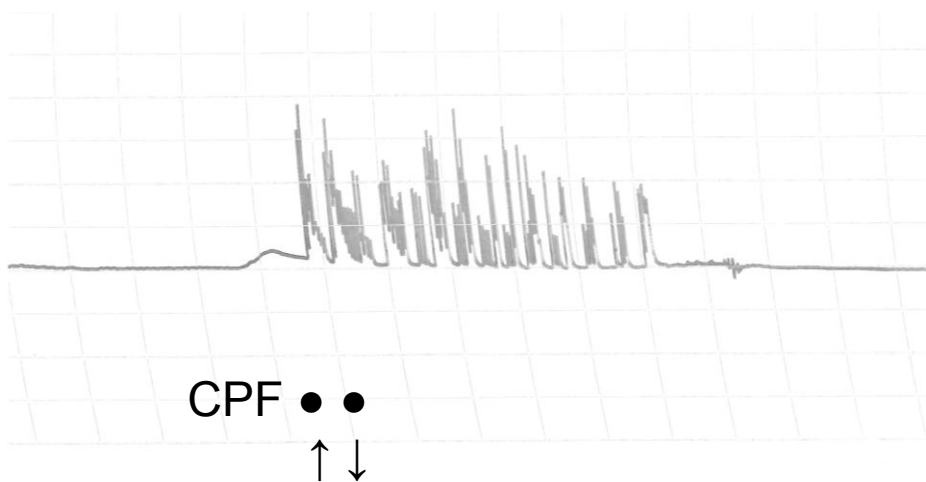

Figure 6.4a.1. Shows a typical trace obtained following CPF (10 $\mu\text{g}/\text{ml}$) on isolated guinea-pig ileum. CPF (10 $\mu\text{g}/\text{ml}$) was added to the bath-fluid at the left hand-side, upward-pointing arrow, and washed off 4-5 times at the adjacent, right hand-side, downward-pointing arrow.

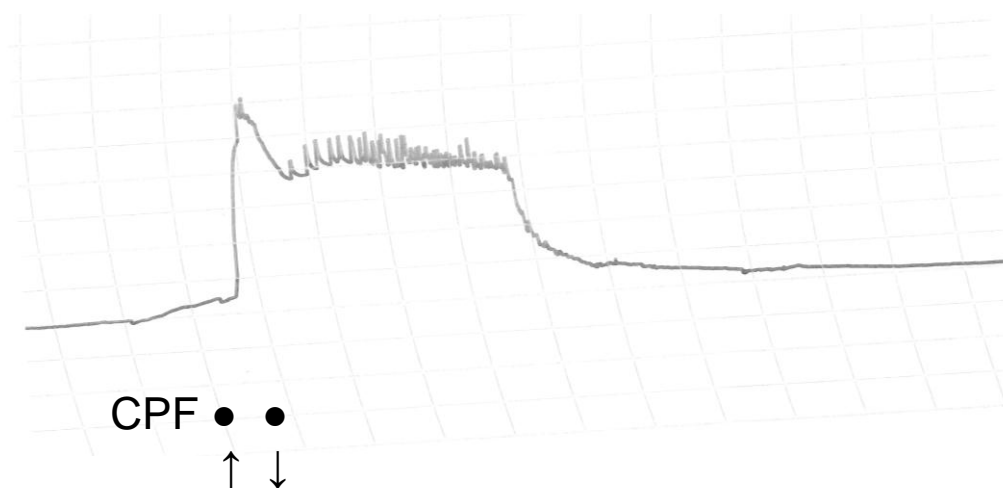

Figure 6.4a.2. Shows typical trace obtained following CPF (20 $\mu\text{g/ml}$) on isolated guinea-pig ileum. CPF (20 $\mu\text{g/ml}$) was added to the bath-fluid at the left hand-side, upward-pointing arrow, and washed off 4-5 times at the adjacent, right hand-side, downward-pointing arrow.

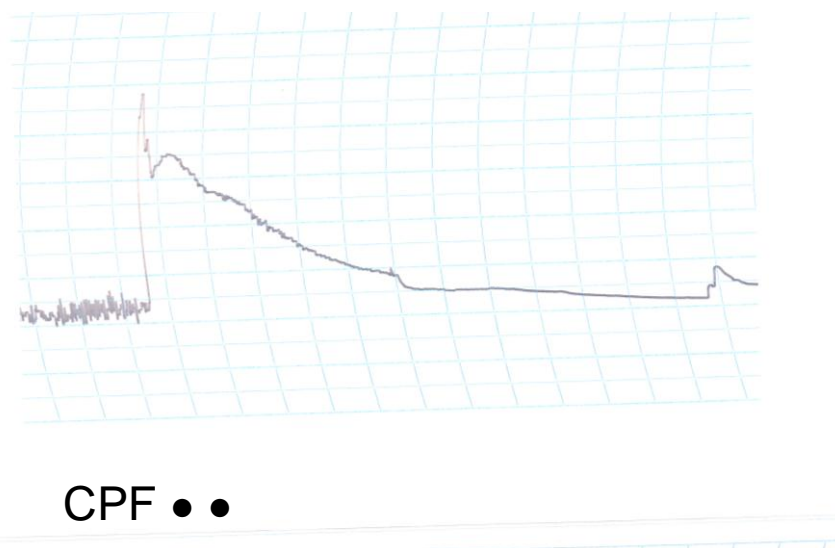

Figure 6.4a.3. Shows typical trace obtained following CPF (40 $\mu\text{g/ml}$) on isolated guinea-pig ileum. CPF (40 $\mu\text{g/ml}$) was added to the bath-fluid at the left hand-side, upward-pointing arrow, and washed off 4-5 times at the adjacent, right hand-side, downward-pointing arrow.

6.4.3. EFFECTS OF CAPSAICIN ON RABBIT ISOLATED

DUODENUM

Relatively low to high concentrations of CFE or CPF (10–160 $\mu\text{g/ml}$) usually induced concentration-related, biphasic responses in rabbit isolated duodenum. These initial inhibitory effects of CFE or CPF were always followed by sharp, significant ($P < 0.05$ – 0.001) increases in the baseline tones (baseline tensions) of the muscle preparations. The increases in contractile amplitudes and baseline tones of the rabbit duodenal muscle preparations were often followed by gradual, concentration-dependent, secondary, longer-lasting, significant ($P < 0.05$ – 0.001) reductions in the amplitudes of the isolated muscle strips (Figure 6.5). The secondary effects of CFE or CPF were resistant to blockade by standard, receptor specific antagonists in all the rabbit isolated muscle preparations examined.

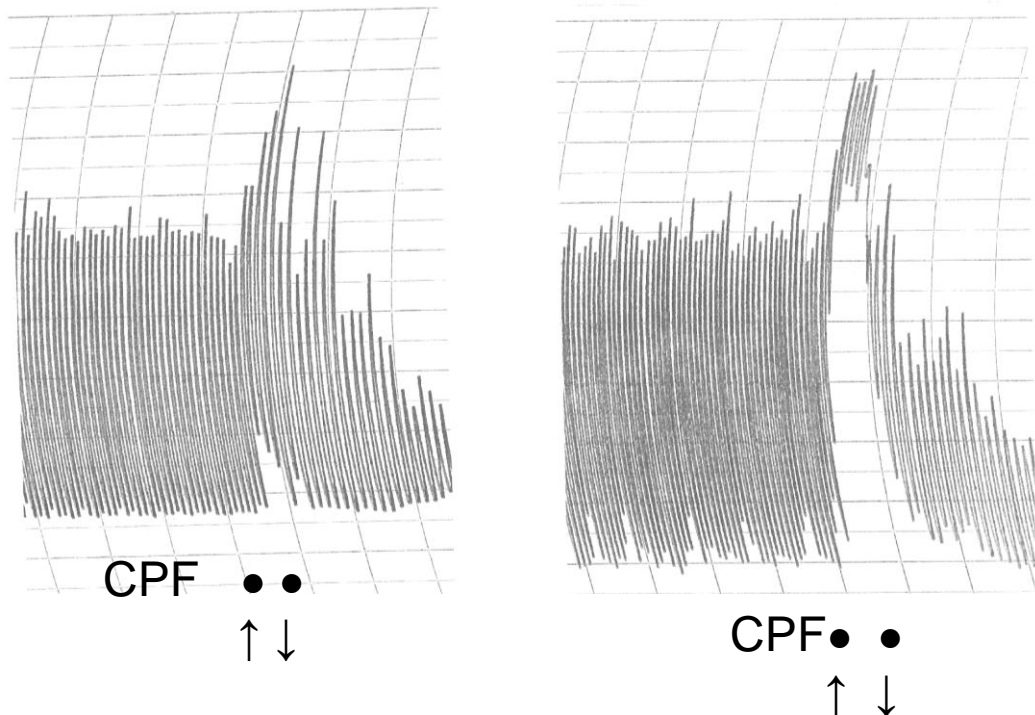
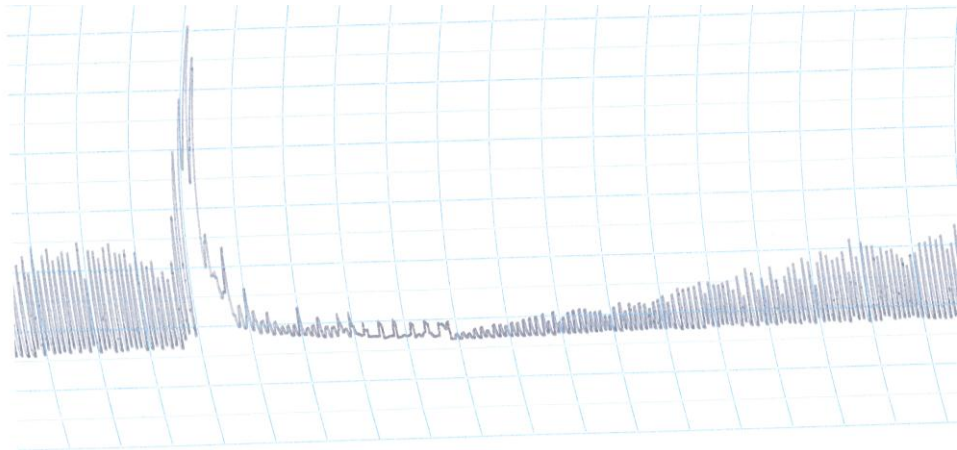
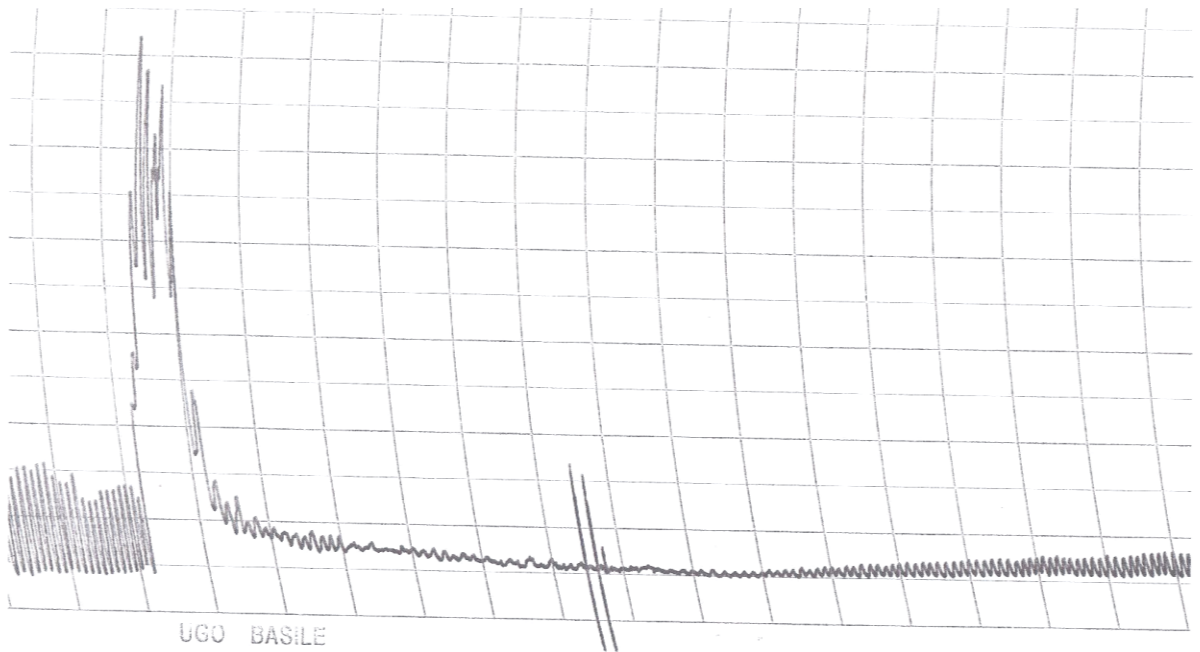

Figure 6.5a.1. Shows a typical trace obtained following CPF (10 $\mu\text{g/ml}$) on rabbit isolated duodenum. CPF (10 $\mu\text{g/ml}$) was added to the bath-fluid at the left hand-side, upward-pointing arrow, and washed off 4-5 times at the adjacent, right hand-side, downward-pointing arrow.



CPF ● ●
 ↑ ↓

Figure 6.5a.2. Shows a typical trace obtained following CPF (20 $\mu\text{g/ml}$) on rabbit isolated duodenum. CPF (20 $\mu\text{g/ml}$) was added to the bath-fluid at the left hand-side, upward-pointing arrow, and washed off 4-5 times at the adjacent, right hand-side, downward-pointing arrow.



CPF ● ●
 ↑ ↓

Figure 6.5a.3. Shows typical trace obtained following CPF (40 $\mu\text{g/ml}$) on rabbit isolated duodenum. CPF (40 $\mu\text{g/ml}$) was added to the bath-fluid at the left hand-side, upward-pointing arrow, and washed off 4-5 times at the adjacent, right hand-side, downward-pointing arrow.

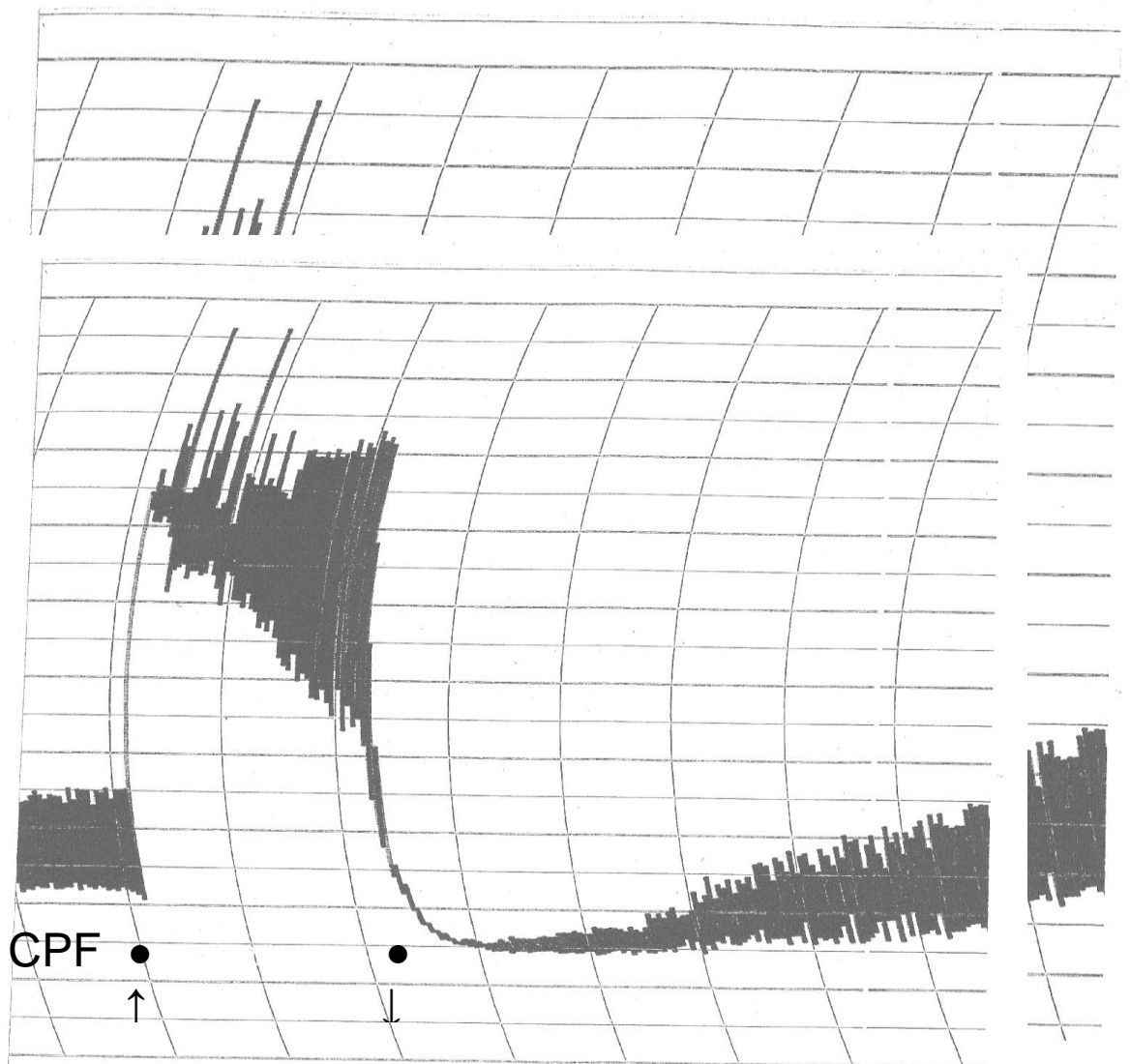

Figure 6.5a.4. Shows a typical trace obtained following CPF (80 $\mu\text{g/ml}$) on rabbit isolated duodenum. CPF (80 $\mu\text{g/ml}$) was added to the bath-fluid at the left hand-side, upward-pointing arrow, and washed off 4-5 times at the adjacent, right hand-side, downward-pointing arrow.

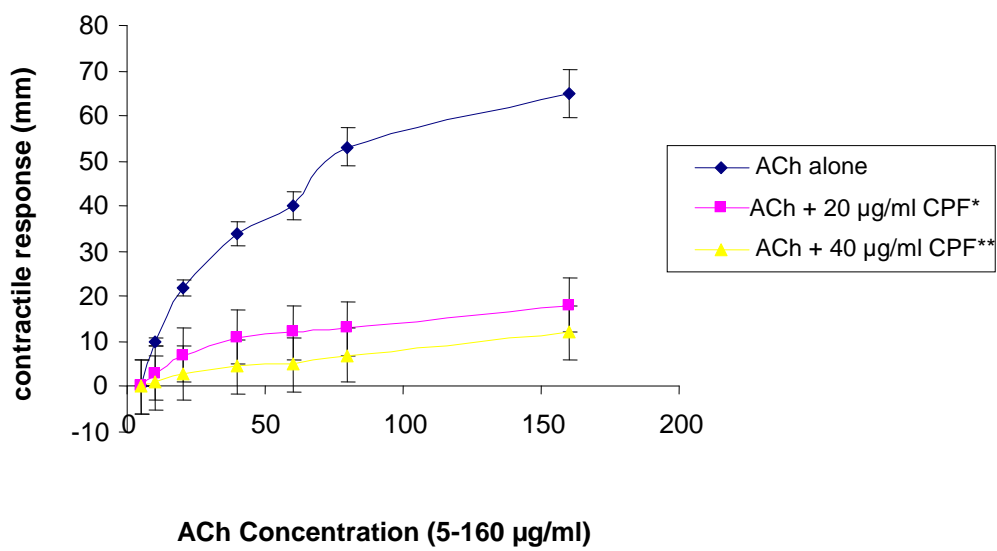

Figure 6.5b. Shows concentration-effect curves to acetylcholine (ACh) in the absence, and in the presence, of CPF (20 µg/ml and 40 µg/ml respectively) on isolated rabbit duodenum. * P< 0.05 ** P< 0.01

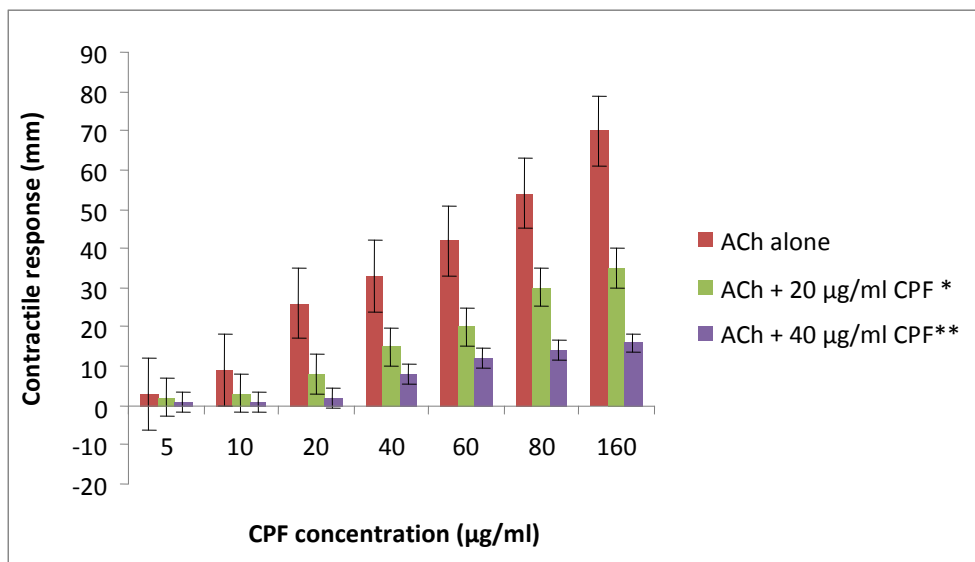

Figure 6.5c. Shows concentration-effect curves to acetylcholine (ACh) in the absence, and in the presence, of CPF (20 µg/ml and 40 µg/ml respectively) on isolated rabbit duodenum. * P< 0.05 ** P< 0.01

6.5. DISCUSSION

Relatively low doses of the capsaicin extract caused significant ($P<0.05$) increases in the basal tone of chick isolated oesophagus and guinea-pig ileum. High doses of the extract increased the basal tone in a biphasic pattern ($P<0.05$) on the chick oesophagus and guinea-pig ileum. Bath-applied acetylcholine (ACh) induced concentration-dependent contractions of the isolated muscle preparations. The contraction noted at high concentration might be due to general stimulant effects of capsaicin through the release of calcium ions. On the other hand, vanilloid receptors in the gastro-intestinal tract (GIT) might have been stimulated at high doses.

The inhibitory effects of CFE or CPF on gastro-intestinal smooth muscles are supported by various studies (Bartho, 1985; Bjorkroth, 1983; Borrelli *et al.*, 2004; Croci *et al.*, 1994). In addition to inhibitory effects on GIT, El-Mahmoudy (2003) showed non-adrenergic, non-cholinergic (NANC) mechanism. Moreover, Goldhill (1999) showed that capsaicin has an antisecretory effect on GIT mucosa. The fact that capsaicin has inhibitory effect on the GIT is supported by earlier studies by Holzer *et al.*, (1992); Jun, (1990); Pothoulakis *et al.*, (1994); and Ralevic, (2001). Moreover, Ralevic (2001) related the inhibitory effects of endocannabinoid substances to interactions via vanilloid receptors. Indirectly, Robinson *et al.*, (2003) showed that Substance P caused early diarrhoea in *Cryptococcus* infected intestine. The precise mechanism of the primary inhibitory effects of the plant's extract on rabbit isolated duodenal muscle preparation is obscure at the moment. However, because the primary inhibitory effects of capsaicin were resistant to blockade by standard, receptor-specific antagonists in all the isolated muscle preparations tested, it is speculated that the secondary, longer-lasting inhibitory and/or depressant effects of capsaicin on rabbit duodenal muscle preparations may be non-specific in nature.

Furthermore, the finding that changes (decrease or increase) in calcium ion concentrations of the bathing physiological solution modified the responses of the isolated tissue preparations to bath-applied concentrations of capsaicin extract would appear to suggest that capsaicin affects calcium mobilization and/or sequestration, and possibly calcium release from its various tissue stores. Further studies are certainly warranted to shed more light on this plausible mechanism of action of capsaicin. The finding earlier reviewed by Del *et al.*, (1991), showed the different pathways by which extracellular Ca^{2+} promotes calcitonin-gene-related-peptide (CGRP) release from central terminals of capsaicin-sensitive afferent pathways of guinea-pigs. Furthermore, the resultant effects of extracellular K^+ and low pH may influence the dialectic nature of the effects of capsaicin on smooth muscles. Santiciolli, *et al.* (1987; 1992) showed the dual nature of capsaicin on neuro-effector and contractile tissues based on pH of the tissues. This corroborates the work of Bleakman (1992) on the effects capsaicin on dorsal root ganglion cells. Olah (2001) has shown that at acidic pH , vanilloid-active agents do effectively stimulate vanilloid receptors.

However, the experimental evidence obtained in the present laboratory animal study indicates that capsaicin behaves like a partial agonist, contracting gastro-intestinal tract smooth muscles when acting alone, while it inhibits the contractility achieved by a pure agonist such as ACh. This observation would appear to provide pharmacological basis for the frequently-reported adverse effects of capsaicin on gastro-intestinal tract (GIT), viz: discomfort or 'upset' commonly associated with capsaicin at very high doses.

Capsicum frutescense Linn. [Solanaceae] has been reported to be rich in sugars, phytosterols, triterpenoids, coumarins, flavonoids and iridoids (Watt and Breyer-Brandwijk (1962); Van Wyk and Gericke (2002)). These chemical compounds could have altered the excitability of the GIT smooth muscles used in this study.

The evidence obtained in the present *in vitro* study further indicates that capsaicin possesses biphasic effects on gastro-intestinal smooth muscle contractility. These findings appear to provide pharmacological rationale for the use of capsaicin as a carminative at therapeutic doses; while high doses may lead to diarrhoea and

'abdominal discomfort'. The gastro-intestinal tract smooth muscle contractile effects of capsaicin may be due, through the complex interactions that might occur among the various chemical constituents of the plant, to the release of mediators and substances that are capable of contracting smooth muscles. Finally, capsaicin may have an allosteric site on smooth muscle membranes, close to ACh binding site, whose conformational changes, following binding, may lead to release of calcium from its storage site. Invariably, capsaicin may act through the NANC neurons via calcitonin-gene-related-peptide (CGRP).

6.6. CONCLUSION

Capsaicin produces biphasic effects on smooth muscles of the GIT. The effects of capsaicin shown in the present study have been reported by many earlier investigators. However, the partial agonistic effect of capsaicin on cholinergic mechanism is shown for the first time, indicating closely-linked allosteric sites of vanilloid receptors to cholinergic sites.

6.7. REFERENCES

- Bartho, L. and Holzer, P. (1985). Search for a physiological role of Substance P in gastrointestinal motility. *Neuroscience*.16 (1): 1-32.
- Bjorkroth, U. (1983). Inhibition of smooth muscle contractions induced by capsaicin and electrical transmural stimulation by a Substance P antagonist. *Acta Physiology Scandinavia Supplement.*; 515: 11-16.
- Bleakman, D. Brorson, J.R. and Miller, R.J. (1990). The effects of capsaicin on voltage-gated calcium currents and calcium signals in cultured dorsal root ganglion cells. *British Journal of Pharmacology*; 101: 423-431.
- Borrelli, F. Raffaele, C. R. Pinto, A. and Izzo, A.A. (2004). Inhibitory effect of ginger (*Zingiber officinale*) on rat ileal motility in vitro: *Life Sciences*; 74 (23): 2889-2896.
- Bowman, W.C. and Everett, S.D. (1964). An isolated parasympathetically-innervated oesophagus preparation from the chick. *Journal of Pharmacy and Pharmacology*; 16 (Suppl.): 72T-79T.
- Castagliuolo, I. Keates, A.C. Qiu, B. Kelly, C.P. Nikulasson, S. Leeman, S.E. and Pothoulakis, C. (1997). Increased Substance P responses in dorsal root ganglia and intestinal macrophages during *Clostridium difficile* toxin A enteritis in rats. *Proceedures of National Academy of Science U S A.* 29; 94 (9): 4788-4793.

- Croci, T. Emonds-Alt, X. and Manara, L. (1994). SR 48968 selectively prevents faecal excretion following activation of tachykinin NK2 receptors in rats. *Journal of Pharmacy and Pharmacology*; 46 (5): 383-385.
- Del, B.E. Santicoli, P. Tramontana, M. Maggi, C.A. Cecconi, R. and Geppetti, P. (1991). Different pathways by which extracellular Ca^{2+} promotes calcitonin gene-related peptide release from central terminals of capsaicin-sensitive afferents of guinea-pigs: Effects of capsaicin, high K^+ and low pH media. *Brain Research*; 566: 46-53.
- Donnerer, J. Bartho, L. Holzer, P. and Lembeck, F. (1984). Intestinal peristalsis associated with release of Substance P. *Neuroscience*; 11: 913-918.
- El-Mahmoudy, A, Matsuyama, H. Khalifa, M. Shimizu, Y. and Takewaki, T. (2003). Tachykinins mediate non-adrenergic, non-cholinergic excitatory neurotransmission to the hamster ileum via NK1 and NK2 receptors. *Life Sciences*. 29; 73 (15): 1939-1951.
- Goldhill, J. Porquet, M.F. and Selve, N. (1999). Antisecretory and relaxatory effects of tachykinin antagonists in the guinea-pig intestinal tract. *Journal of Pharmacy and Pharmacology*; 51(9): 1041-1048.
- Guard, S. McKnight, A.T. Watling, K.J. and Watson, S.P. (1991). Evidence for two types of tachykinin receptors on cholinergic neurons of the guinea-pig ileum myenteric plexus. *Annual New York Academy of Science*; 632: 400-403.
- Gyires, K. (2004). Neuropeptides and gastric mucosal homeostasis. *Current Topics in Medicinal Chemistry*; 4(1): 63-73 (11).
- Holzer, P. (1991). Capsaicin: Cellular targets, mechanisms of action, and selectivity for thin sensory neurons. *Pharmacological Reviews*; 43: 143-201.

- Holzer, P. Lippe, I.T. and Amann, N. (1992). Participation of capsaicin-sensitive afferent neurons in gastric motor inhibition caused by laparotomy and intraperitoneal acid. *Neuroscience*; 48: 715-722.
- Holzer, P. and Holzer-Petsche, U. 1997). Tachykinins in the gut. Part I. Expression, release and motor function. *Pharmacology and Therapeutics*; 73: 173-217.
- Holzer, P. and Holzer-Petsche, U. (1997). Tachykinins in the gut. Part II. Roles in neural excitation, secretion and inflammation. *Pharmacology and Therapeutics*; 73: 219-263.
- Mantyh, C.R. Gates, T.S. Zimmerman, R.P. Welton, M.L. Passaro Jr, E.P. Vigna, S.R. Maggio, J.E. Kruger, L. and Mantyh, P.W. (1988). Receptor binding sites for Substance P, but not substance K or neuromedin K, are expressed in high concentrations by arterioles, venules, and lymph nodules in surgical specimens obtained from patients with ulcerative colitis and Crohn disease. *Proceedings of National Academy of Science U S A*; 85(9): 3235-3239.
- Mantyh, C.R. Gates, T. Vigna, S.R. and Maggio, J.E. (1988). Receptor binding sites for Substance P and substance K in the canine gastrointestinal tract and their possible role in inflammatory bowel disease. *Neuroscience*; 25 (3): 817-837.
- McCafferty, D.M. Sharkey, K.A. and Wallace, J.L. (1994). Beneficial effects of local or systemic lidocaine in experimental colitis. *American Journal of Physiology*; 266: G560-567).
- Nakanishi, S. (1991) Mammalian tachykinin receptors. *Annual Review of Neuroscience*; 14: 123-136.
- Ojewole, J.A.O. (1976). Studies on the Pharmacology of Some Antimalarial Drugs. PhD Thesis, University of Strathclyde, Glasgow.
- Olah, Z. Karai, L. and Iadarola, M.J. (2001). Anandamide activates vanilloid receptor 1 (VR1) at acidic p^H in dorsal root ganglia neurons and cells

- ectopically expressing VR1. *Journal of Biological Chemistry*; 276(33): 31163-31170.
- Otsuka, M. Yoshioka, K. (1993) Neurotransmitter functions of mammalian tachykinins. *Physiological Reviews*; 73:229-308.
- Pothoulakis, C. Castagliuolo, I. LaMont, J.T. Jaffer, A. O'Keane, J.C. Snider, R.M. and Leeman, S.E. (1994). CP-96,345, a Substance P antagonist, inhibits rat intestinal responses to clostridium difficile toxin A but not cholera toxin. *Proceedures of National Academy of Science U S A*; 91 (3): 947.
- Ralevic, V. Kendall, D.A. Jerman, J.C. Middlemiss, D.N. and Smart, D. (2001). Cannabinoid activation of recombinant and endogenous vanilloid receptors I. *European Journal of Pharmacology*; 424 (3): 211-219.
- Renzi, D. Pellegrini, B. Tonelli, F. Surrenti, C. and Calabro, A. (2000). Substance P (neurokinin-1) and neurokinin A (neurokinin-2) receptor gene and protein expression in the healthy and inflamed human intestine. *American Journal Pathology.*; 157(5): 1511-1522.
- Robinson, P. Okhuysen, P.C. Chappel, C.L. Weinstock, J.V. Lewis, D.E. Actor, J.K. and White Jr, A.C . (2003). Substance P expression correlates with severity of diarrhoea in cryptosporidiosis. *Journal of Infectious Disease*; 15; 188 (2): 290-296.
- Santicioli, P. Patacchini, R. Maggi, C.A. and Meli, A. (1987). Exposure to calcium-free medium protects sensory fibers by capsaicin desensitization. *Neuroscience Letters*; 80: 167-172.
- Santicioli, P. Del Bianco, E. Geppetti, P. and Maggi, C.A. (1992). Release of calcitonin gene-related peptide-like (CRGP-LI) immunoreactivity from rat isolated ileus muscle by low p^H, capsaicin and potassium. *Neuroscience Letters*; 143: 19-22.

- Sasai, Y. and Nakanishi, S. (1989). Molecular characterization of rat substance K receptor and its mRNAs. *Biochemistry Biophysics Research Communication*; 165: 695-702.
- Takahashi, K. Tanaka, A. Hara, M. and Nakanishi, S. (1992). The primary structure and gene organization of human Substance P and neuromedin K receptors. *European Journal of Biochemistry*; 204: 1025-1033.
- Van WYK, B. E. Van Oudtshoorn B, Gerickek, N. (2002) *Medicinal Plants of South Africa* (2nd ed.), Briza Publications, Pretoria :156–157.
- Watt, J.M. Breyer-Brandwijk, M. G. (1962). *The medicinal and poisonous plants of Southern and East Africa*: 862-942.

CHAPTER 7

Effects of capsaicin on coagulation

SUMMARY: This study investigated the effect of capsaicin on coagulation. Ten animals in each of three treatment groups received 2.5, 5.0, 10 mg/kg (i.p.) capsaicin respectively. Compared to the control group, the mean INR was statistically significant ($P < 0.05$). Taken together, the use of capsaicin at therapeutic doses (2.5-10.0 mg/kg) may reduce thromboembolism without any clinically relevant alteration in platelets.

7.1. INTRODUCTION

Primary homeostasis is produced by the action of platelets and blood vessels (Petrovitch, 2002; Rubin, 2001). Secondary homeostatic mechanism is enhanced by the interaction of many plasma proteins known as “clotting factors” in various sequence to produce fibrin. Often, specific medications are used to enhance or inhibit individual step in coagulation cascade. Various phytochemicals have been shown to interact with these clotting mechanisms (Mohammed, 1986; Ariga, 1981; Boullin, 1981; Greuwald, 2000; Yuan 2003; De Smet, 2002). The side-effects of uncontrolled use of these herbal remedies could be disastrous from severe bleeding episodes (Rose, 1990; Rowin, 1996; Fessenden, 2001); hepatotoxicity (Gebhardt, 1993), nephrotoxicity, and cardiopulmonary complications (Garges, 1998). *Capsicum spp.* constitutes a part of the oldest herbal medications known for more than 5000 years. Some of the beneficial effects of *Capsicum spp.* include anti-tumour and calminative effects, as well as their usefulness in the treatment of acute

and chronic pain (Weil, 1981). Recent study by Jaiarj *et al.* (1998) found that capsaicin acting on the heat sensitive vanilloid receptors had thrombolytic effects. Although this was a comment on the review of cardiovascular effects of capsaicin, the evidence was not strong enough. Jaiarj *et al.* (1998) also observed that individuals who consumed a large amount of *Capsicum* have lower incidence of thromboembolism. The objective of this study was to investigate the coagulatory benefits of capsaicin, which is the active vanilloid-sensitive agent in *Capsicum spp.*

7.2. MATERIALS AND METHODS

7.2.1. ANIMALS

Experiments were performed on male Wistar rats (250-300 g). The rats were maintained under standard laboratory conditions of light, temperature, and relative humidity. The animals were fed with standard diet pellet and drinking tap water *ad libitum* and kept in the Biomedical Resource Unit of the University of KwaZulu-Natal, Durban.

7.2.2. HAEMATOLOGICAL TESTS FOR COAGULATION

In a pilot study, 10 Wistar rats (250-300 g) had oral treatments of 50 mg/kg of *Capsicum frutescens* fruit extract (CFE). The tissue's morphology was examined grossly from the oesophagus to the intra-abdominal organs.

In the definitive study, Wistar rats weighing 250–300 g were divided into two groups (A and B) of control and treated animals. They had similar demographics in terms of sex, age, and weight. All the animals were fed with standard diet pellet and drinking tap water *ad libitum*. Group A consisted of 10 untreated animals which served as controls. Group B consisted of 3 treatment groups of 10 animals per group, treated with CFE, 2.5, 5.0, or 10.0 mg/kg i.p., respectively. Following treatment, 1.5-2 ml blood was collected by intracardiac puncture, following deep halothane anaesthesia. The blood specimens were analysed for their platelets, as

well as the internationalised normalised ratio (INR) of prothrombin. In a parallel study, 3 groups of 10 Wistar rats per group were treated with 8 mg/kg of capsaicin extract daily for 2 weeks. From each animal, 2 ml of blood was collected by intracardiac puncture, following deep halothane anaesthesia. The specimens were analysed for urea and creatinine.

7.3. RESULT

The results obtained show dose- and time-independent variations of INR in the treated groups, compared to the controls. The difference mean INR between the treated groups was statistically significant ($p < 0.05$), showing INR of 1 ± 0.1 , 1.4 ± 0.1 and 2.0 ± 0.3 , respectively, for the treated groups of CFE, 2.5, 5.0 and 10 mg/kg, respectively. Earlier pilot study showed macroscopic evidence of erosion, mucosal oedema, bleeding and ulceration, following oral administration of capsaicin extract at 50 mg/kg. In parallel studies, capsaicin did not show any renal complications in rats that were exposed to capsaicin treatments at therapeutic doses (8 mg/kg) daily for 2 weeks. The mean urea and creatinine were 5.4 ± 0.3 mmol/L and 45 ± 1 μ mol/L, respectively, in the rats.

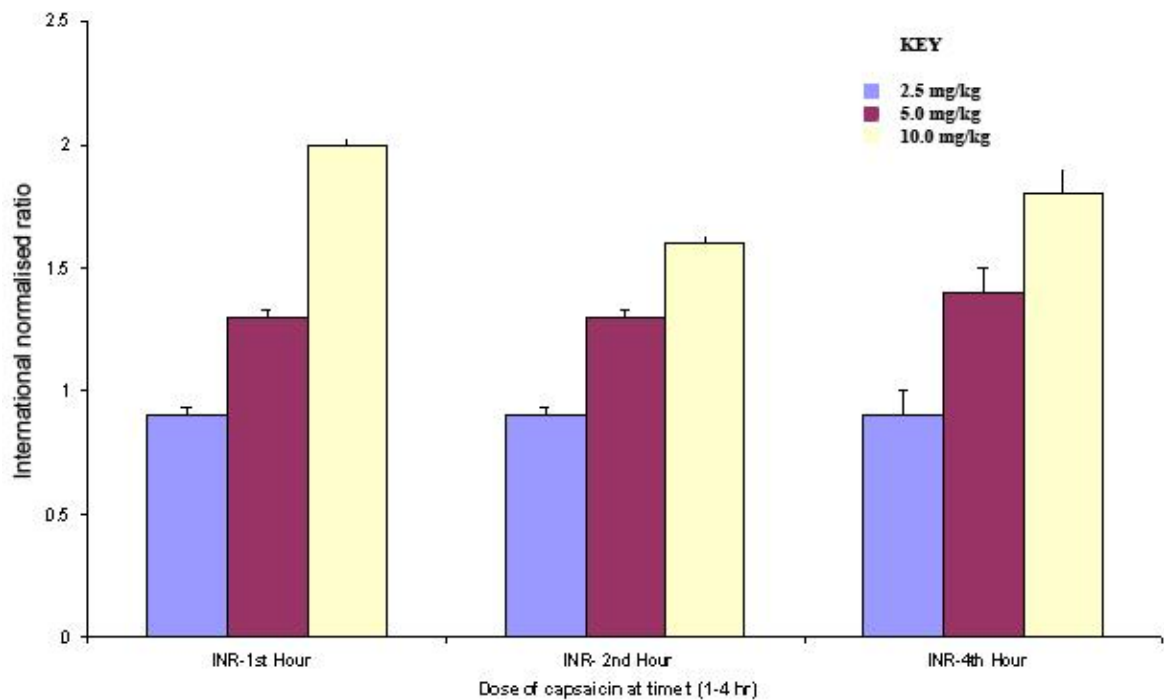

Figure 7.1. Shows dose-related increase in INR from 5-10 mg/kg i.p.capsaicin

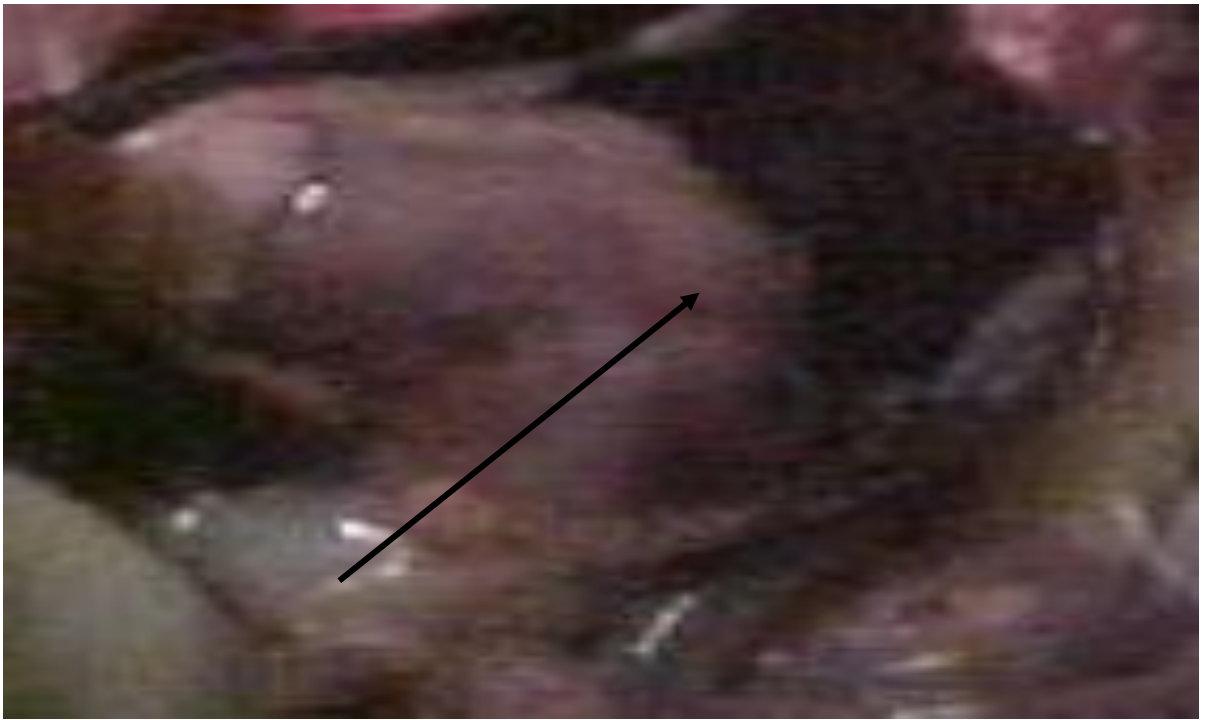

Figure 7.2. Arrow showing gastric erosion following oral capsaicin at 50 mg/kg

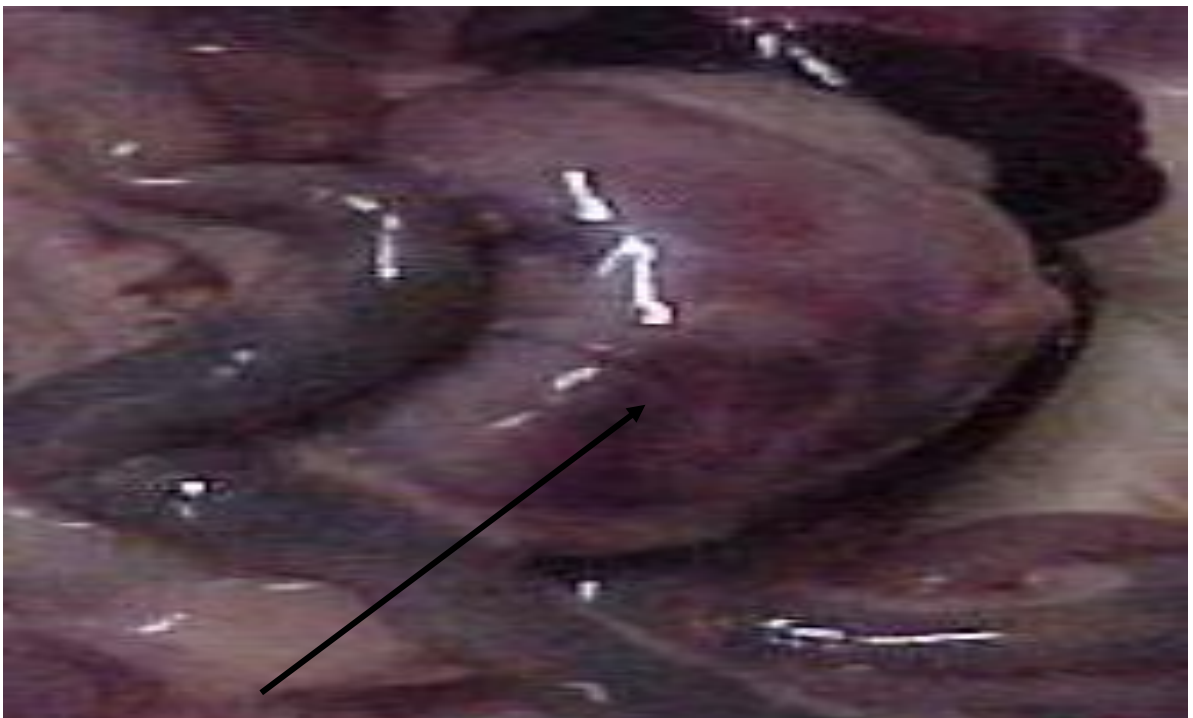

Figure 7.3. Arrow showing gastric ulceration from chemical burns following 50 mg/kg oral capsaicin.

7.4. DISCUSSION

For a medication to impact on coagulation, it has to affect the Virchow's triad of the blood vessel, blood flow and blood viscosity (Virchow, 1856 and 1858, Brotman, *et al.*, 1981). The flow is influenced by the rheology of blood and the container. Considering Newtonian fluids, Fung reviewed the various factors influencing flow as represented below:

$$\text{Flow Rate} = (p_1 - p_2) \times d^4 \times \pi / 128 \times l \times \eta \quad (\text{Fung, 1993})$$

Where p_1 = pressure at the entry of a vessel, p_2 = pressure at the exit of a vessel, and d^4 = double square of the diameter of the vessel, $p_1 - p_2$ = pressure gradient across a vessel, l = length of the vessel and the viscosity of the Newtonian fluid.

Considering this mathematical relationship, one will discover the interaction of the inner and the external diameters of the vessel, the pressure gradient in the flowing liquid, length of the vessel as well as the viscosity on the flow. To flow, the fluid has to overcome a resistive force, which is twice as great as the diameter of the vessel and frictional forces produced by viscosity. Although blood is a non-Newtonian fluid, the role of viscosity as well as vessel narrowing in the capillary and other microcirculation, is essential for the processes of diapedesis and platelet plugging in homeostasis (Chin, 2001; Byung, 1990). The platelets, microaggregates from white corpuscles and clotting factors, could be viewed as responsible for the viscosity, the pressure head being provided upstream by peripheral vascular resistance and the central pump of the heart, while the length and consistency of vessel calibre greatly relate the other variables in the formula. For capsaicin to affect coagulation, it has to influence one or more of the three notable variables of the triad, i.e., the flow, the vessel or the constituents.

The role of capsaicin in the flow of blood has not been substantiated. Available evidence suggests that it may cause vasodilation, presenting as 'goose flesh' in

Wistar rats following i.p administration. Jaiarj *et al.*, (1998) also observed that capsaicin does increase platelet adhesion. It is debatable if this increase is statistically or clinically significant. Furthermore, the effects of capsaicin on clotting factors have received inconclusive evidence.

The standard methods of coagulation monitoring include measurements of bleeding time, prothrombin time (PT), or the measurement of Internationalised Normalised Ratio (INR). Bleeding time is the best estimate for platelets' qualitative function, but it lacks correlation with clinical bleeding, hence, the little value with its use. In addition, bleeding time estimates may be more difficult to assess in laboratory animals. But platelets count is useful for the estimation of quantitative function. However, the quantitative estimation of platelets has little to do with the function of platelets. The PT and INR are useful to estimate extrinsic and common pathways. The intrinsic and common pathways can be assessed by the partial prothromboplastin time (PTT), activated partial thromboplastin time (aPTT), and the activated clotting time. For the purpose of this study, the platelets counts, as well as the INR, were used as tests of extrinsic and common pathways. Intraperitoneal administration of capsaicin without any direct or intrinsic vessel injury was expected to affect intrinsic pathway, the extrinsic pathway, and the common pathway in a similar manner; hence the use of common indicators such as the platelets count and the INR.

The results obtained in this study show that platelets number was within normal range in the 'test' animal groups. Although platelet adhesion was found in the study by Jaiarj *et al.*, (1998), the present investigation could not document any platelet clumping, rouleaux formation or any increased adhesion in the 'test' animal groups. However, the trend of INR in the animals showed dose-dependent increase. This may reflect the tendency for capsaicin to influence the clotting factors through the common pathway, or the extrinsic coagulatory pathway. However, there have been reports of capsaicin affecting the release of Hageman factor-calcium. Calcium is a rate-limiting catalyst at various phases of coagulation (Stoelting *et al.*, 2002).

The discussion on coagulation and anti-platelet activity cannot be laid to rest without considering the role of prostaglandins in renal and gastro-intestinal

functions. Inhibition of prostaglandin in the stomach and the kidneys has led to gastric ulcer or haemorrhage, and nephrotoxicity. This is because prostaglandin is a modulator of gastric mucosal blood flow, and it is important for the maintenance of renal glomerular blood flow. Although INR is prolonged by capsaicin, renal function in a parallel study remained normal following prolonged exposure to capsaicin.

The effect of capsaicin on coagulation provides alternate non-antiprostaglandin mechanisms of thromboprophylaxis without the inherent nephrotoxicity and gastropathy common with most currently-used antithrombotic anti-platelet agents at therapeutic doses. Alternative non-oral and parenteral routes might improve the side-effect profile of capsaicin by the use of subcutaneous, intramuscular, or as enteric-coated capsules. The exact factor, or plasma proteins altered in the coagulatory cascade by capsaicin is beyond the scope of the present study.

7.5. CONCLUSION

This study shows that capsaicin has dose-dependent prolongation on the INR. This may be due to inhibition of platelet adhesion, or indirectly, due to haemoconcentration. This view supports the work of Jaiarj *et al.* (1998) which shows that capsaicin has antithrombotic effects. Unlike the report of Jaiarj *et al.* (1998), however, the present study suggests that the anti-thrombotic effect of capsaicin is related to its effects on the common and/or the extrinsic pathway, rather than any antiplatelet activity. Addition of capsicum to meals may achieve the required thromboprophylaxis, especially in the population at risk.

7.7 REFERENCES

- Ariga, T. Oshiba, S. and Tamada, T. (1981). Platelet aggregation inhibitor in garlic. *Lancet*: 150-151.
- Boullion, D.J. (1981) Garlic as a platelet inhibitor. *Lancet*; 1:776-777.
- Brotman, D. J. Deitcher, S. R. Lip, G.Y. and Matzdorff, A.C. (2004) Virchow's triad revisited. *Southern Medical Journal*, Birmingham, Alabama, 97 (2): 213-214.
- Byung, C.E. (1990). Generalization of the Hagen–Poiseuille velocity profile to non-Newtonian fluids and measurement of their viscosity. *American Journal of Physics*; (8)1: 83-84.
- Chin, C. W. (2001). Computational rheology for pipeline and annular flow: Non-Newtonian flow modeling for drilling. *Technology*: 272-274.
- De Smet, P. (2002). Herbal remedies. *New England Journal of Medicine*; 347: 2046-2047
- Fesselden, J.M. Wittenborn, W. and Clarke, L. (2001). Ginkgo biloba: A case report of herbal medicine and bleeding postoperatively from a laparoscopic cholecystectomy. *American Surgery*; 67: 33- 35.
- Fung, Y.C. (1993). *Biomechanics: Mechanical properties of living tissues*. Medical; 592-593.

- Garges, H.P. Varia, I. and Doraiswamy, P.M. (1998). Cardiac complications and delirium associated with valerian root withdrawal. *Journal of American Medical Association*; 280: 1566-1568
- Gebhardt, R. (1993). Multiple inhibitory effects of garlic extracts on cholesterol biosynthesis in hepatocytes. *Lipids*; 26: 613-615
- Greuwald, J. (2000) (ed) *Physicians' desk reference for herbal medicines*, 2nd ed. Montvale, New Jersey Medical Economics.
- Jaiarj, P. Saichompoo, S. Wongkrajang, Y. Vongswan, N. Peungvicha, P. and Jiratchariyakul, W. (1998). Cardiovascular actions of capsaicinoids extract. *Thai Capsicum Thai Journal of phytopharmacy*; 5(2): 1-13.
- Petrovitch, C.T. (2002). An Approach to the patient who may have bleeding disorder. *American Society of Anaesthesia Annual Refresher Course*; 174: 1-6.
- Mohammed, S.F. and Woodward, S.C. (1986). Characterization of a potent inhibitor of platelet aggregation and release reaction isolated from *Allium ativum* (garlic). *Thrombosis Research*; 44: 793-796
- Rose, K.D. Croissant, P.D. Parliamet, C.F. and Levin, M.B. (1990) Spontaneous spinal epidural hematoma with associated platelet dysfunction from excessive garlic ingestion: A case report. *Neurosurgery* 26: 880-882.
- Rowin, J. Lewis, S.L. (1996). Spontaneous bilateral subdural hematomas associated with chronic ginkgo biloba ingestion. *Neurology* 46: 17775-17777
- Rubin, R.N. (2001). Hematological diseases. *National Medical Series for Independent Study- Medicine* 4th ed-Lippincott Williams & Wilkins-Philadelphia: 109-154

- Stoelting, R.K. and Dierdorf, S.F. (2002) Anaesthesiology and co-existing diseases. 4th ed. Churchill Livingstone. New York: 490-492.
- Virchow, R. L. K. (1858) Die Cellular pathologie in ihrer Begründung auf physiologische und pathologische Gewebelehre. Berlin, A. Hirschwald, 1858. English translation by F. Chance: Cellular Pathology. Philadelphia, J. B. Lippincott, 1963.
- Virchow, R. L. K. (1856) Thrombose und Embolie. Gefässentzündung und septische Infektion In: Gesammelte Abhandlungen zur wissenschaftlichen Medicin. Frankfurt am Main, Von Meidinger & Sohn:219-732 . English translation by A. C. Matzdorff and W. R. Bell: Thrombosis and Emboli. Canton, Massachusetts, Science History Publications, 1998.
- Weil, A. (1981). Eating Chilies. The marriage of the Sun and Moon. Houghton Mifflin Company: 28-36.
- Yuan, C.S. and Bieber, E.J. (eds.) (2003). Textbook of complimentary and alternative Medicine. New York, Parthenon.

CHAPTER 8

Effects of Capsaicin on cardiovascular function using Legendorff's heart preparation

SUMMARY: The present study investigated the effects of capsaicin on the myocardial contractility using Legendorff's apparatus. The results showed biphasic effects with concentration-dependent increases in the heart rate from a capsaicin concentration of 0.05 µg/ml up to a concentration of 0.3 µg/ml ($P < 0.001$), and decreases in the mean heart rate from a concentration of 0.3- 1 µg/ml ($P < 0.001$). The slope of the left ventricular diastolic pressure per unit change in time (dp/dt) showed a concentration-dependent reduction in the left ventricular contraction when treated with capsaicin at a concentration range of 0.05-1 mcg/ml ($P < 0.001$). Unlike earlier studies, the bulk of the evidence from this study showed that capsaicin extract may not be the best agent to protect the heart against ischaemia-reperfusion injury.

8.1. INTRODUCTION

Capsaicin has been in use for over 5000 years by the human race, notably as spices (Weil, 1981). Not until recently has research efforts been directed towards its nature and physiological actions. Significant progress had been made in the understanding of the actions of capsaicin in humans, notably on the central nervous system (CNS), gastrointestinal tract (GIT), and pain management. The pharmacodynamic effects of capsaicin on the cardiovascular system remain elusive. Some actions of capsaicin on

the heart were attributed to an interaction with K⁺ channels (Castle, 1992), liberation of neuropeptides, most notably calcitonin-gene-related-peptide (CGRP) from the vanilloid-sensitive innervation of the heart (De Siqueira, et al., 2006; Franco-Cereceda et al., 1988; 1991; Ono *et al.*, 1989). The possibility of a direct effect of capsaicin on the heart via a cardiac vanilloid receptor (VR), or through interaction of vanilloid receptors with purinergic receptors and subsequent release of nitric oxide (NO), leading to vasodilatation were considered. Evidence abound in the literature that Ca²⁺ ions are released through 1, 4, 5 inositol phosphatase by the release of phospholipase C, or through interaction of the vanilloid receptors with cannabinoids.

This study was designed to investigate the effects of capsaicin on heart rate, cardiac contractile force, coronary perfusion, ischaemic-reperfusion effects, with the aim of obtaining a better understanding of the effects of capsaicin on the myocardium.

8.2. METHODS

8.2.1. ANIMALS

Experiments were performed on male Wistar rats (250-300 g body weight). The rats were maintained under standard laboratory conditions of light, temperature, and relative humidity. The animals were fed with standard pellet diet and drinking tap water *ad libitum*, and kept in the Biomedical Resource Unit of the University of KwaZulu- Natal, Durban. The animals' hearts were harvested following passive euthanasia subsequent to cervical vertebrae disarticulation.

8.2.2. MYOCARDIAL STUDIES

Six rats' hearts were prepared and treated with 0.05-1 µg/ml of capsaicin extract in a 50-ml Lagendorff's apparatus. Seven concentrations of capsaicin extract were administered, including CFE, 0.05, 0.1, 0.2, 0.4, 0.6, 0.8 and 1.0 µg/ml, respectively. The end points measured were changes in the heart rate, coronary

perfusion pressure, and the left ventricular contractions, using a constantly perfused rat heart in Langendorff's apparatus.

Following treatments, the hearts were exposed to 30-min ischaemia followed by 60-min reperfusion. The hearts were then treated with 1% triphenyltetrazolium chloride (TTC) (Holmbom, *et al.*, 1993); an agent that stains tissues and allows them to retain their architecture. Histopathological slides of the hearts were prepared and examined for evidence of ischaemia and/or infarction, using a simple microscope. The results were compared with the controls with the help of a Pathologist.

8.3. RESULTS

The results show a concentration-dependent and significant increase in the heart rate from a capsaicin concentration of 0.05 $\mu\text{g/ml}$ to a concentration of 0.3 $\mu\text{g/ml}$ ($P < 0.001$). Thereafter, there was a concentration-dependent decrease in the mean heart rates from a concentration of 0.3 to a concentration of 1 $\mu\text{g/ml}$ ($P < 0.001$). Statistical calculations were done using Graph Pad Prism 4 software and the Microsoft excel.

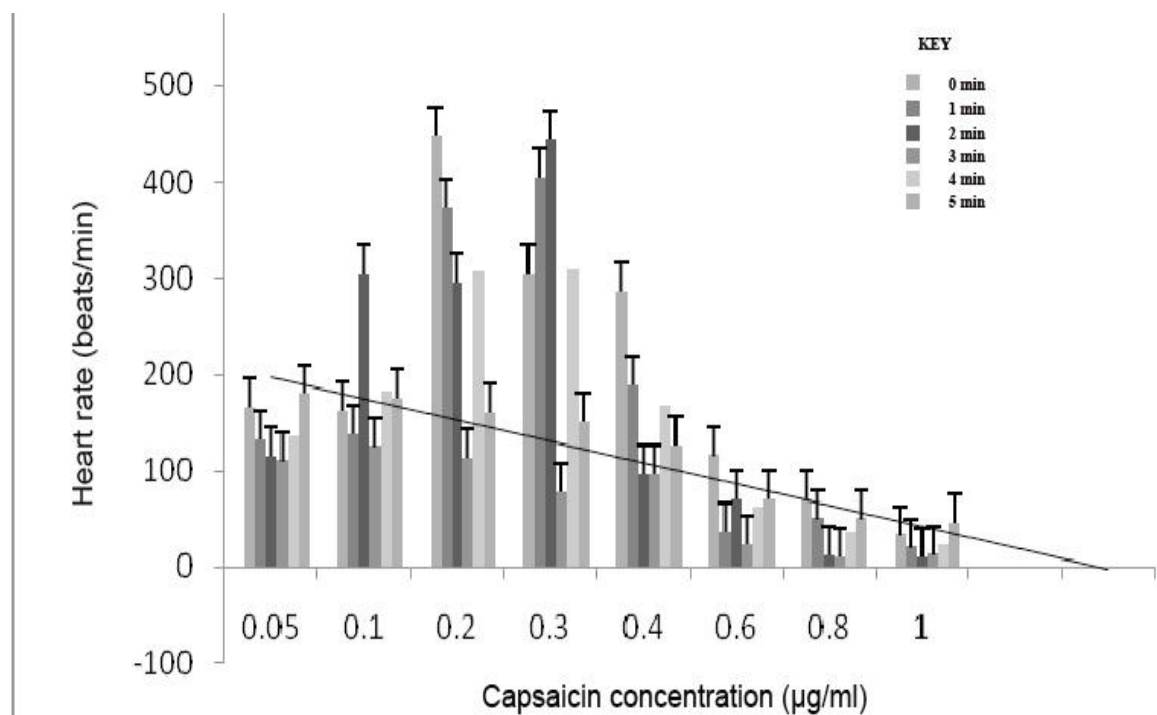

Figure 8.1. Biphasic chronotropic effects of CFE on rats' hearts.

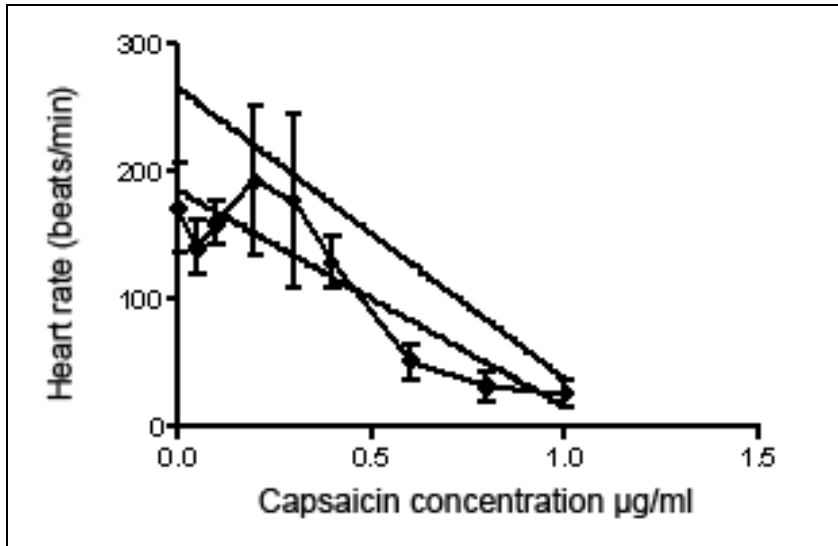

Figure 8.2. Regression analysis of capsaicin. Effects of escalated concentrations of capsaicin extract (CFE, 0.05-1.0 $\mu\text{g/ml}$) on rats' hearts using Langendorff's apparatus.

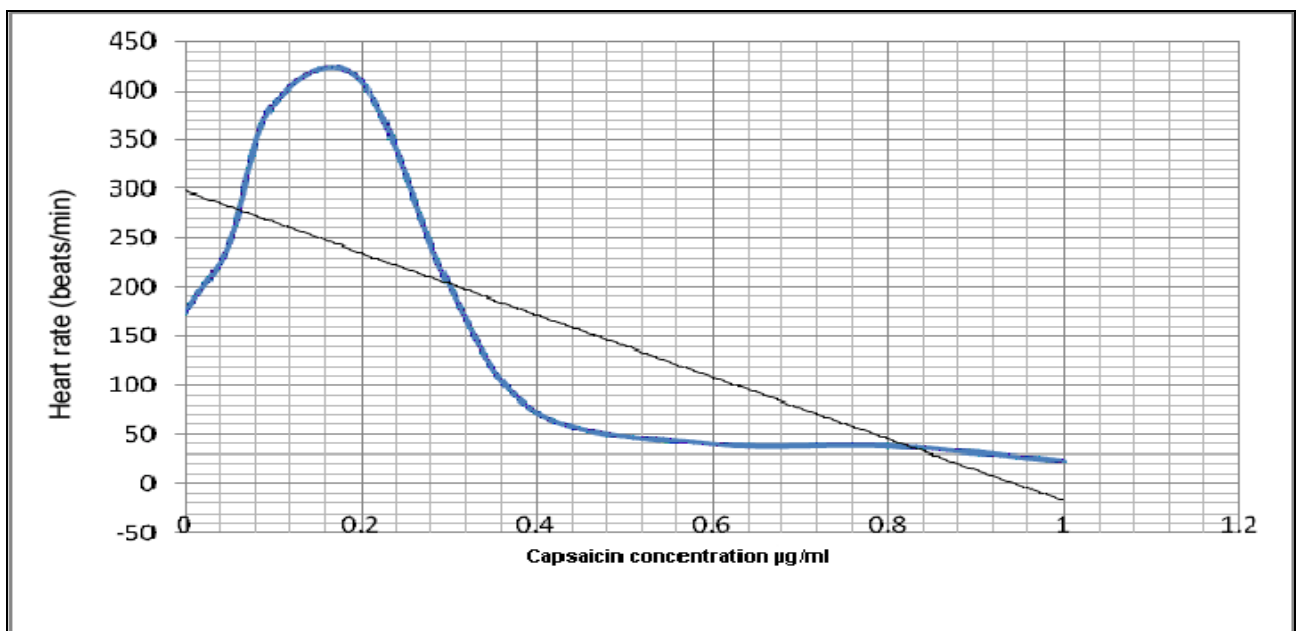

Figure 8.3. Best line of fit for a slope running from y to x axis showing a drop in the heart rate following capsaicin administration.

Left ventricular diastolic pressures (in unit time) were computer-generated using the ADT PowerLab data acquisition. It showed a concentration-dependent reduction in left ventricular contraction.

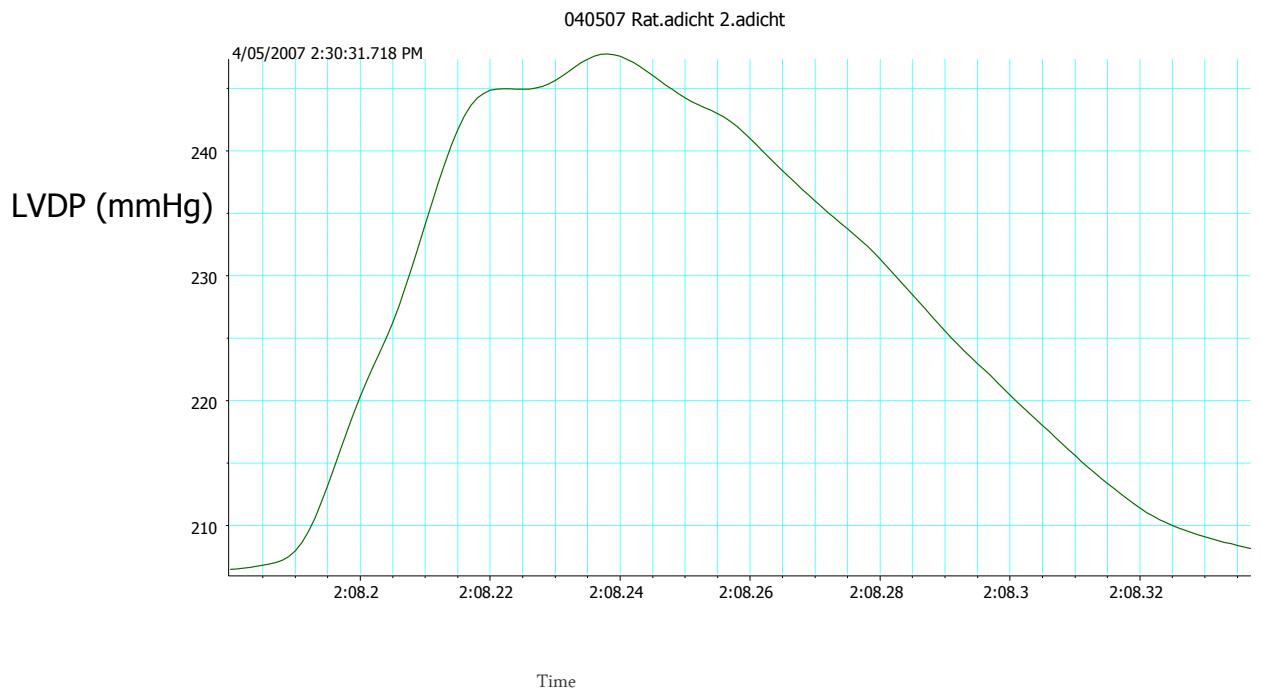

Figure 8.4.1. LVDP/Time curve at 2 min.

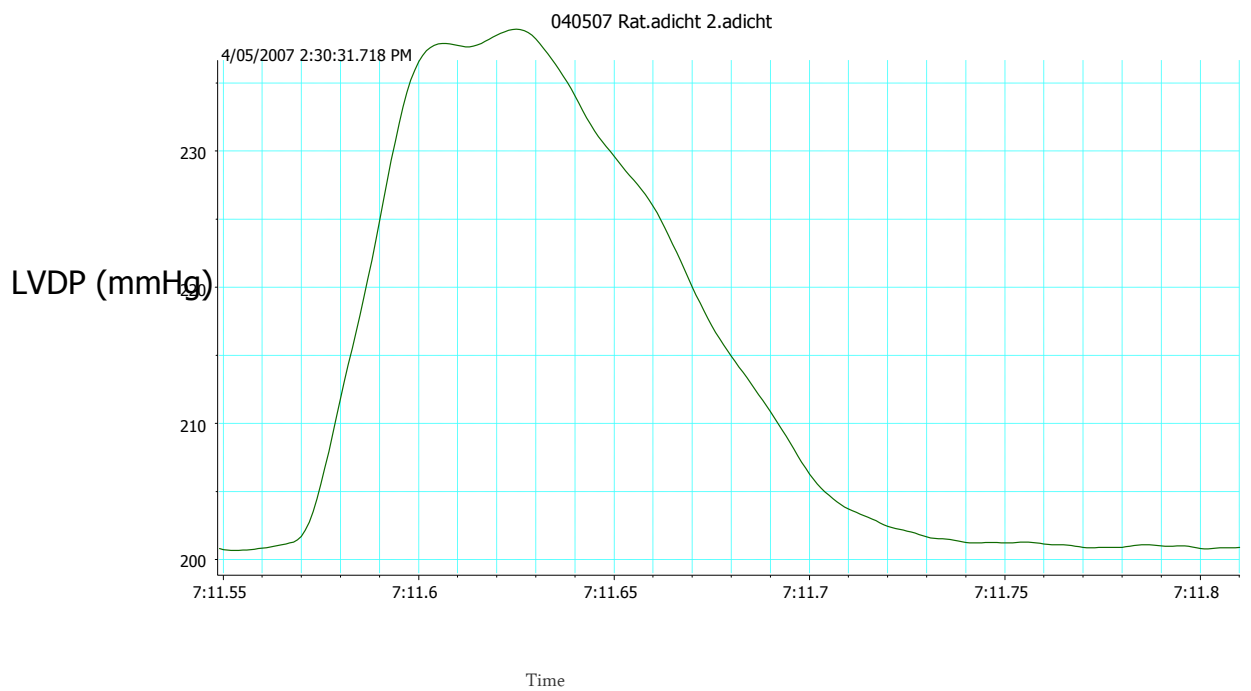

Figure 8.4.2. LVDP/Time curve at 7 min.

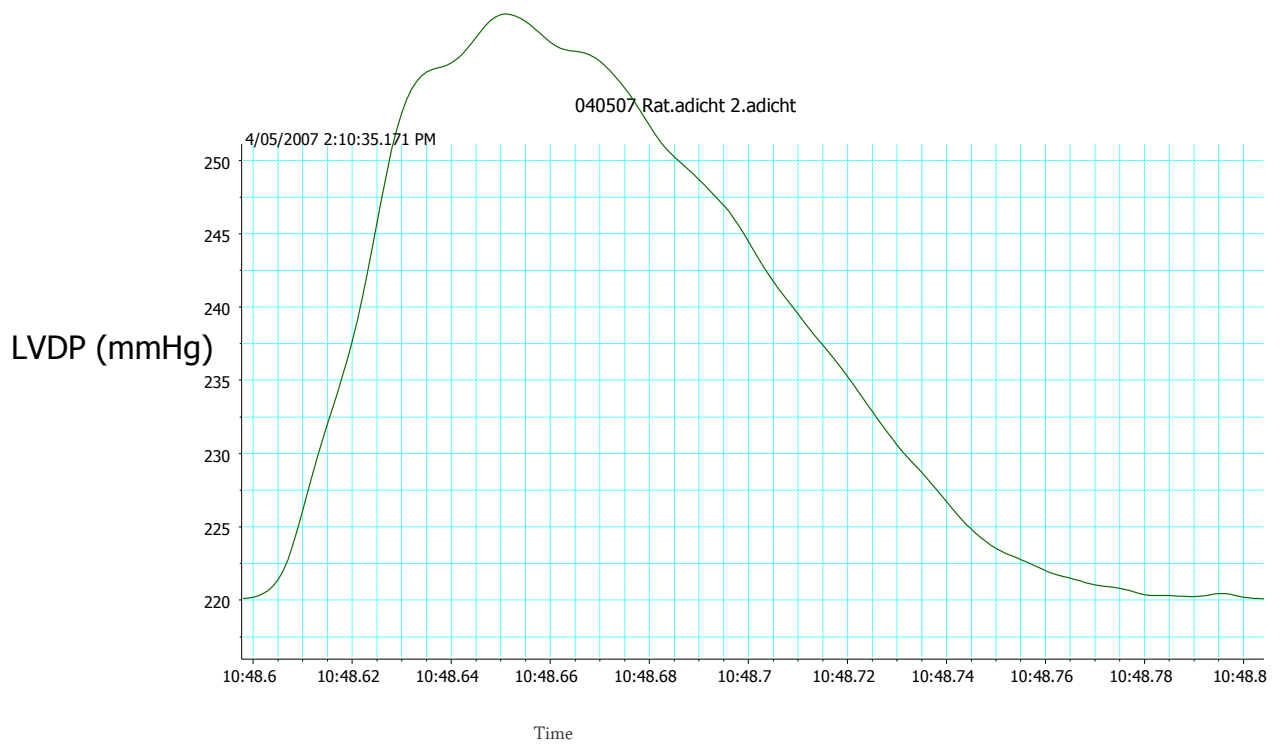

Figure 8.4.3. LVDP/Time curve at 10 min.

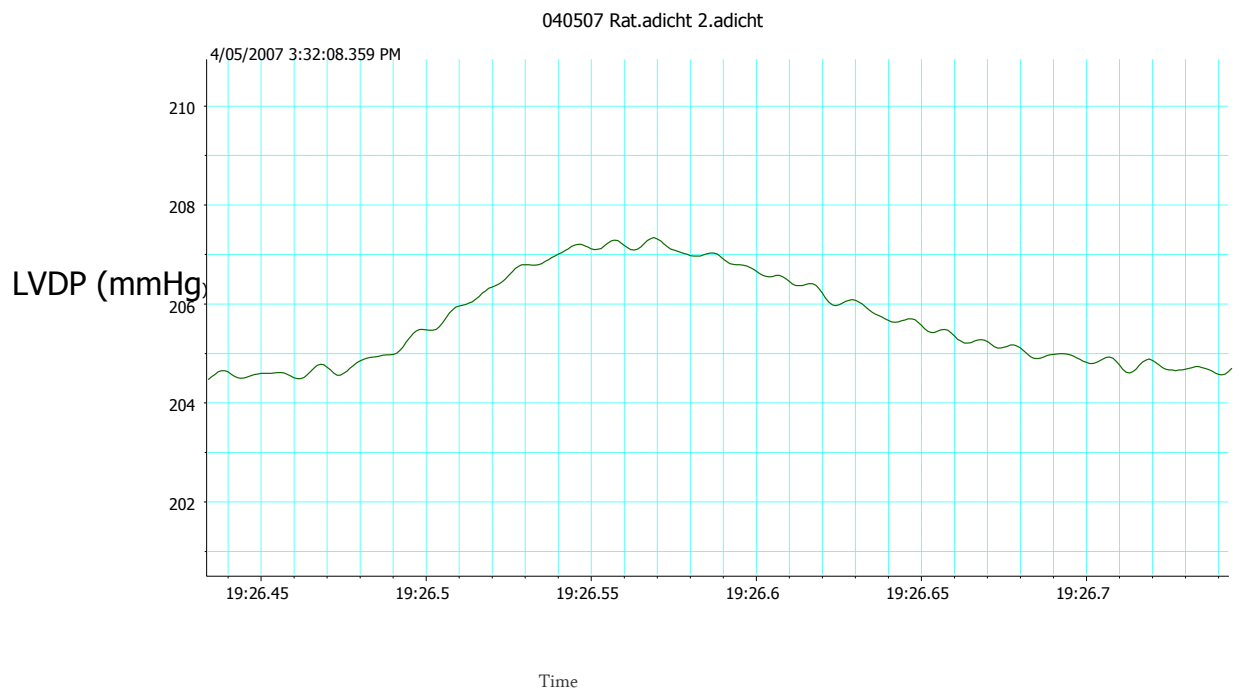

Figure 8.4.4. LVDP/Time curve at 19 min.

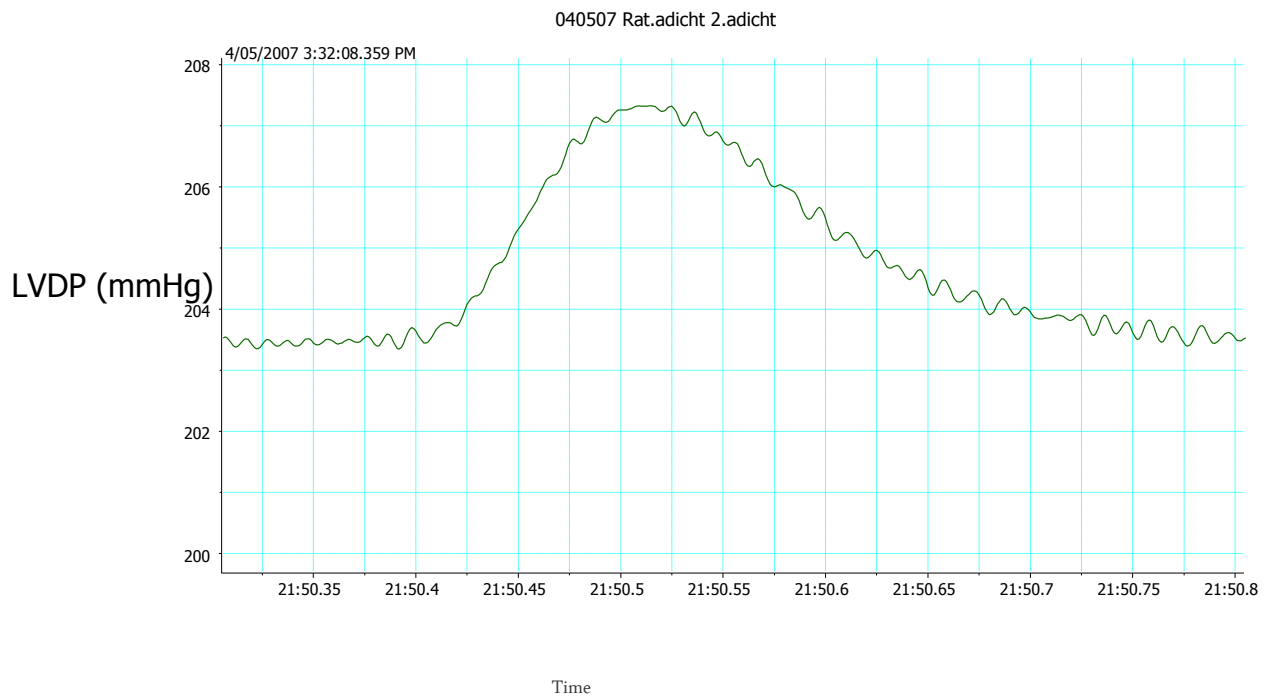

Figure 8.4.5. LVDP/Time curve at 21 min.

The slope of these curves (dp/dt) were computed and analysed. This parameter is a measure of the left ventricular contraction. The result obtained shows a concentration-dependent reduction in the left ventricular contraction when treated with capsaicin at a concentration range of 0.05-1 mcg/ml ($P < 0.001$).

Figure 8.5. Mean changes in rats' dp/dt in relation to capsaicin treatments using Langendorff's apparatus

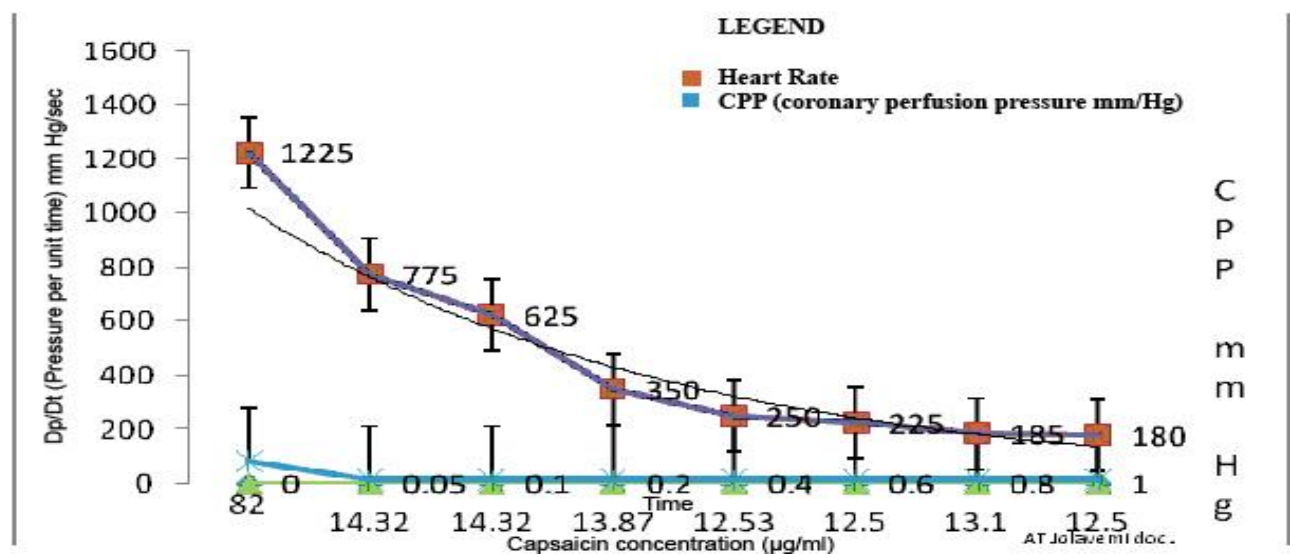

Figure 8.5a. Mean changes in rats' dp/dt in relation to capsaicin treatments using Langendorff's apparatus.

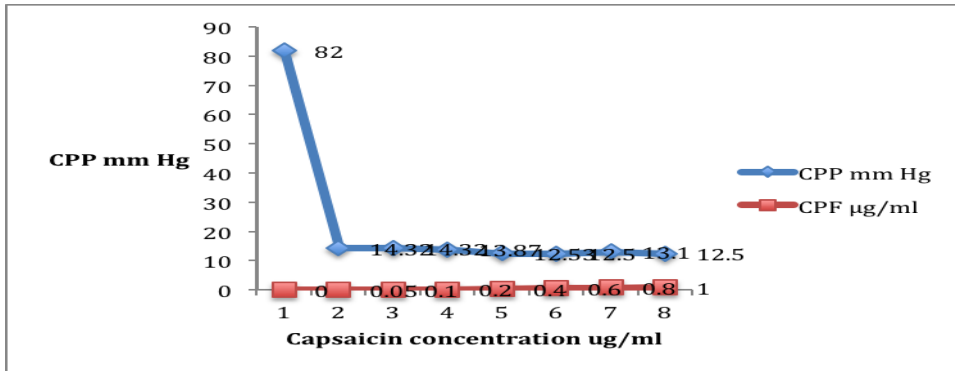

Figure 8.5b showing reduction in the CPP with increasing doses of capsaicin

8.3.2. Effects of Capsaicin on ischaemic-reperfusion injury

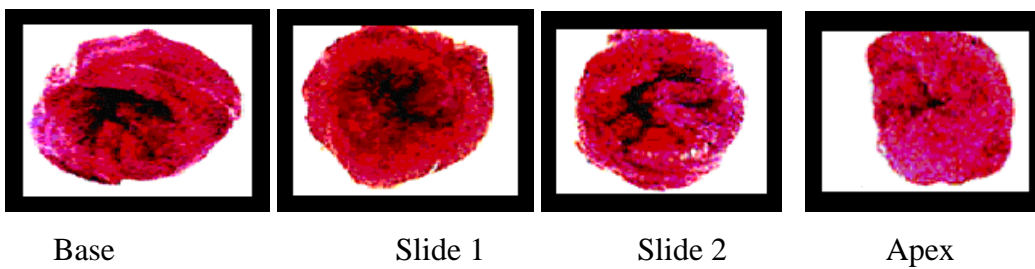

Figure 8.6.1. Pathological slides for control rats.

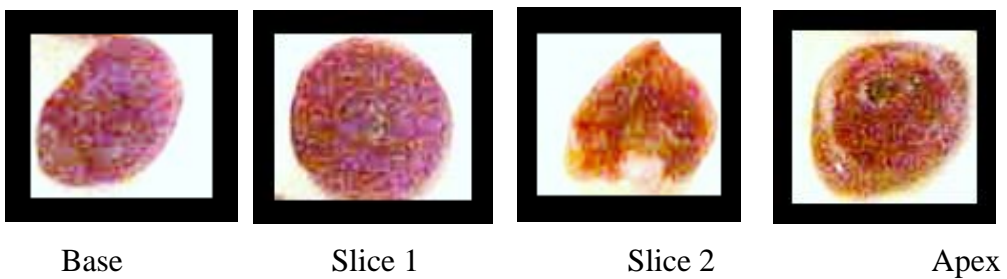

Figure 8.6.2. Pathological slides for rat 2, showing reduction in the uptake of TTC stain by infarcted tissue.

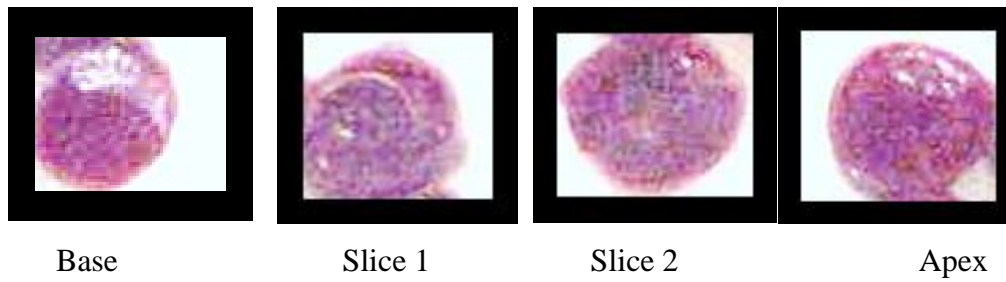

Figure 8.6.3. Pathological slides for rat 3- Better uptake in TTC stain shows better protected cardiac muscles.

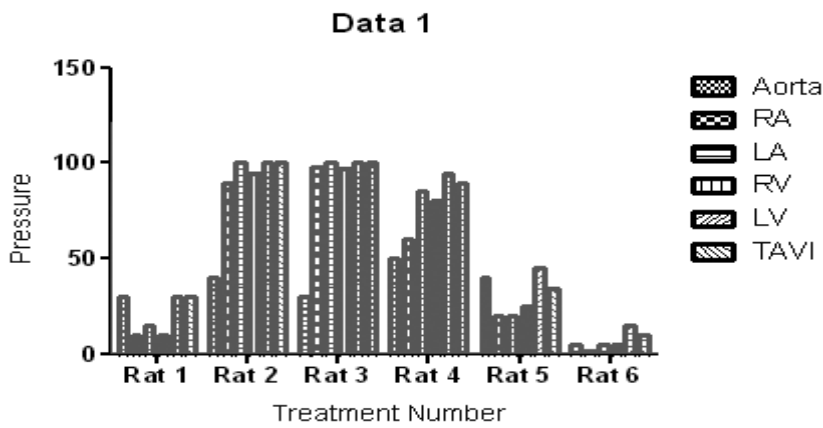

Figure 8.7. Degree of myocardial ischaemia and/or infarction at specific sites caused by ischaemia-reperfusion injury following 2-hr reperfusion in capsaicin-pretreated rat hearts.

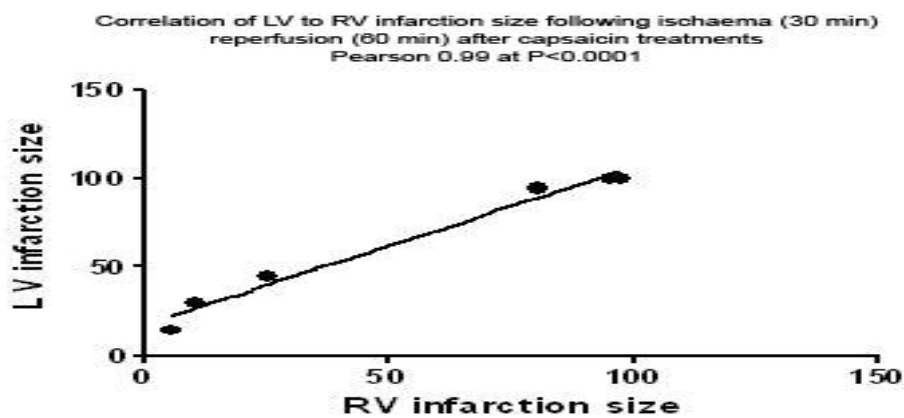

Figure 8.8. Correlation between infarct size of left and right ventricles following ischaemic reperfusion injury in capsaicin pretreated rat hearts.

8.4. DISCUSSION

Capsaicin acts on vanilloid receptors, which are groups of receptors that are heat sensitive. In the recent past, significant progress has been made in the molecular and functional characterization of the sub-family now known as “transient receptor potential” including TRP V1 (capsaicin-bound vanilloid receptor), and “transient receptor potential melastatin” -TRPM (Fleig and Penner, 2004). TRPM channels are involved in several physiological and pathological states in electrically-excitabile and non-excitabile cells. This fact has generated an intense interrogation on possible medicinal uses of capsaicin, and in drug discovery.

Available evidence in the literature about the changes in heart rate following capsaicin administration is mixed. Majority of reports show an increase in heart rate with increasing doses of capsaicin. A positive chronotropic and inotropic effects of calcitonin-gene-related-peptide (CGRP) and capsaicin was found in the study by Franco-Cereceda and Lundberg (1985). The investigators suggested that release of CGRP from local sensory nerves within the heart underlies the cardio-stimulatory response to capsaicin. Injection of capsaicin into *area postrema* in rats led to significant increases in the heart rate, blood pressure and renal sympathetic nerve activity (Xue and He, 2000). Using a single capsaicin dose of 0.1µl, Nemeth *et al.*, (2001) noted that the heart rate and coronary perfusion decreased significantly in streptozotocin-induced diabetic rats. The question remains as to why capsaicin could increase heart rate and blood pressure at a certain time and equally cause paradoxical reduction of these variables at other times in the same animals. Chang *et al.*, (2000) shed light on the possible hypothesis for these paradoxical effects of capsaicin. When used alone at a dose of 100 nmol, capsaicin caused tachycardia due to the release of tachykinins. However, capsaicin at the same dose caused bradycardia following pre-treatment with CRGP (Chang *et al.*, 2000). It was deduced that these capsaicin effects were mediated through the axon reflex which stimulated the cholinergic neurons of intrinsic cardiac ganglia.

Furthermore, application of some capsaicin doses (1, 3, 10, 30, 100 and 300 micrograms) by Quest *et al.*, (1984) to cerebro-ventricular regions of chloralose-anesthetized cats, the 4th ventricle or the *cistern magna*, resulted in significant

increases in the heart rate and blood pressure. Similar treatment and restriction of capsaicin treatments into the fore-brain ventricles failed to elicit any significant increase in the heart rate or blood pressure. This observation led the investigators to conclude that the area on ventral surface of the medulla is extraordinarily sensitive to capsaicin, and may serve as the site of capsaicin-induced changes in cardiovascular function.

Moreover, Malinowska *et al.*, (2001) observed in their study, that activation of vanilloid receptors on sensory vagal nerves elicits rapid bradycardia and hypotension (Bezold-Jarisch reflex). Recent *in vitro* experiments revealed that the endogenous cannabinoid ligand, anandamide acts as an agonist at the vanilloid VRI receptors. Malinowska *et al.*, (2001) also discovered that intravenous injection of anandamide, its stable analogue methanandamide, and the vanilloid receptor agonist capsaicin, produced a dose-dependent immediate and short-lasting decrease in heart rate and blood pressure in the following rank order of potencies: capsaicin > methanandamide > anandamide. Malinowska *et al.* (2001) concluded that the endogenous cannabinoid receptor agonist anandamide, and its stable analogue methanandamide, induce reflex bradycardia and hypotension (phase I) by activating vanilloid VRI receptor. Whereas the mechanism underlying the brief vasopressor effect (phase II) is unknown, the prolonged hypotension (phase III) probably results from stimulation of the cannabinoid CB1 receptor.

In another development, the TRPM ion channel sub-family was found by Fleig and Penner (2004) to have a profound effect on the regulation of ion homeostasis by mediating direct influx of Ca^{2+} and Mg^{2+} ions entry, and subsequent determination of the potential of the cell membrane. Ambdukhar (2006) suggested that the Ca^{2+} signalling microdomains were important platforms for the assembly and regulation of the TRPC channels. On the basis of these theories, it could be speculated that the alteration of Ca^{2+} and Mg^{2+} homeostasis by capsaicin acting on the vanilloid receptors (TRPM sub-family of receptors), the calcitonin-gene-related-peptides, vasointestinal peptides (VIPs), and cannabinoid receptors, would explain the changing behavioural patterns of capsaicin. Thus, capsaicin could produce sweet and bitter, sharp or non-sharp taste, analgesia and hyperalgesia, bradycardia or

tachycardia, hypotension or transient increase in blood pressure at cellular, molecular, tissue and systemic level.

A plausible explanation for the dose-dependent positive chronotropic effect of capsaicin could be its ability to release calcium. Moreover, release of magnesium from cardiomyocytes might contribute to bradycardia, reduction in coronary perfusion pressure, and hypotension from reduction in afterload. In the same vein, alteration in the electrolytes may lead to arrhythmias.

In order to retain the architecture of the tissue, triphenyltetrazolium chloride (TTC) macroscopic staining was done following ischaemia-reperfusion studies. In comparison with the control, the results show evidence of ischaemia and segmental infarction with diffuse area of necrosis. The degree of infarction/necrosis varied from 10%-100% ($P < 0.0001$). Expectedly, the infarction was worse in both ventricles and least in the right atrium and the aorta.

Results from earlier studies show that capsaicin protects ischaemic hearts from ischaemia-reperfusion injury. The bulk of the evidence from this study shows that the myocardium was irreversibly damaged after ischaemia-reperfusion, following pretreatment with capsaicin. Although incremental doses of capsaicin were used, this should rather protect against ischaemia-reperfusion based on 'multiple-hit theory', rather than the contrary.

On the contrary, the reperfusion period of 60 minutes might be questioned as being insufficient. In earlier studies, Schwarz *et al.* (2000) observed that there was no statistical significance between a reperfusion time of 60 and 90 minutes, using triphenyltetrazolium chloride (TTC) macroscopic staining of rat hearts in ischaemia-reperfusion studies. Furthermore, TTC had been found to provide a distinct demarcation between viable myocardium (which stains as red), and the non-viable myocardium, staining as pale pink, blue, or reddish-brown (Greve and Saetersdal, 1991; Figure 2-9).

In clinical studies, the use of beta-blockers and angiotensin converting-enzyme-inhibitors (ACEI) have shown tremendous benefits from reduction in the heart rate, thereby improving oxygen demand and supply ratio as in beta-blockers, and

reduction of the destructive neurohumoral modeling, following ischaemia by the use of ACEI, respectively, (Grolleau-Raoux, 1976; Hearse, *et al.*, 1985; Kroll and Knight, 1984; Michael, *et al.*, 1999). In this study, the heart rate reduced significantly, but with paradoxical and poor inotropic effects at very low heart rates. It could be inferred that capsaicin is able to reduce heart rate, as well as impede myocardial performance at high doses. The evidence of arrhythmias, ineffective contraction from significant reductions of dp/dt max, poses a challenge to the efficacy of high doses of capsaicin in myocardial ischaemia. Capsaicin may have its benefits at low doses in ischaemia, probably from a primary release of magnesium, followed by a massive release of calcium in ischaemia, causing more damage, and lipid peroxidation resulting in deleterious inflammatory response syndrome to myocardial ischaemia (Turnstall, *et al.*, 1986; Sun, *et al.*, 1995; White, *et al.*, 1983; Yamashita, *et al.*, 1998; Yang, *et al.*, 1996).

8.5. CONCLUSION

Capsaicin has a biphasic effect on the cardiovascular system. At low doses, there was tachycardia, probably from the release of tachykinin with calcium as the secondary messenger. This was followed by a dose-dependent bradycardia at higher doses, probably from the release of magnesium ions. Possible evidence of cross-talk between capsaicin-activated vanilloid receptors and calcitonin-gene-related-peptides system could be inferred. The reduction in myocardial contractility, heart rate and coronary perfusion supports a tendency for hypotension, as alluded to by earlier workers (Jaiarj *et al.*, 1998). While 33% of the studied hearts had less than 20% infarction, further work is needed to establish the role of capsaicin as a cardio-protective agent in ischaemia-reperfusion injury.

8.7. REFERENCES

- Castle, N.A. (1992) Differential inhibition of Potassium currents in rat ventricular myocytes by capsaicin. *Cardiovascular Research*; 26:1137-1144
- Chang, Y., Hoover, D.B., Hancock, J.C. (2000) Endogenous tachykinins cause bradycardia by stimulating cholinergic neurons in the isolated guinea pig heart *American Journal of Physiology Regulation and Integral Comparative Physiology* 278 (6): R1483-R1489
- De Siqueira, R.J.B., Leal-Cardoso, J.H, Couture, L. R. (2006) Role of capsaicin-sensitive sensory nerves in mediation of the cardiovascular effects of the essential oil *Croton zehntner* leaves in anaesthetized rats. *Clinical and Experimental Pharmacology and Physiology* 33 (3), 238–247.
- Fleig, A., Penner, R. (2004) The TRPM ion channel subfamily: Molecular, biophysical and functional features. *Trends in Pharmacological Sciences*: 633-639.
- Franco-Cereceda, A., Lundberg, J. M. (2004) The role of neuropeptide Y in the bovine fetal cardiovascular response to reduced oxygenation. *The Journal of Physiology*. 546 (3), 891–901.
- Greve, G., Saetersdal, T. (1991) Problems related to infarct size measurement in the rat heart. *Acta Anatomica*;142: 366-373.
- Grolleau-Raoux, D. (1976) Drug protection of the myocardium during cardiac surgery. *Annals of Anesthesiology French*; 17(2):1411-1421.
- Hearse, D.J, Erol, C., Robinson, L.A., Maxwell, M.P., Braimbridge, M.V. (1985) Developments in cardioprotection- “polarized arrest as an alternative to depolarized arrest. *Journal Thorac Cardiovascular Surgery*; 89 (3):428-438

- Holmbom, B., Naslund, U., Eriksson, A., Virtanen, I., Thornell, L.E. Comparison of triphenyltetrazolium chloride (TTC) staining versus detection of fibronectin in experimental myocardial infarction. *Histochemistry*. 1993; 99:265–275.
- Jaiarj, P. Saichompoo, S. Wongkrajang, Y. Vongswan, N. Peungvicha, P. and Jiratchariyakul, W. (1998). Cardiovascular actions of capsaicinoids extract. *Thai Capsicum Thai Journal of phytopharmacy*; 5(2): 1-13.
- Kroll, D.A., Knight, P.R. (1984) Antifibrillatory effects of volatile anesthetics in acute occlusion/reperfusion arrhythmias. *Anesthesiology*; 61(6):657-661
- Kuzuya, T., Hoshida, S., Yamashita, N., Fuji, H., Oe, H., Hori, M., Kamada, T., Tada, M. (1993) Delayed effects of sublethal ischemia on the acquisition of tolerance to ischemia. *Circulatory Research*. 1993; 72:1293–1299.
- Malinowska, B. Kwolek, G. and Gothert, M. (2001) Anandamide and methanandamide induce both vanilloid VR1- and cannabinoid CB1 receptor-mediated changes in heart rate and blood pressure in anaesthetized rats. *Nauyn-Schmiedeberg's Archives of Pharmacology*. 364: 562–569.
- Marshall, I. (1992) Mechanism of vascular relaxation by the calcitonin gene-related peptides. *Annals of the New York Academy of Sciences*; 657 (1), 204–214
- Michael, I Z., Thomas, T., Eliana, .L, Ellis, J., Marina, K., Carol, P.H., David, R., Jeffrey SH. (1999) Beneficial effects from [beta]-adrenergic blockade in elderly patients undergoing noncardiac surgery. *Anesthesiology*. 91(6):1674
- Nemeth, J. Srivasky, Z. Oroszi, G. (2001) Impaired capsaicin-induced decrease in the heart rate and coronary flow in isolated heart of diabetic rat. *Acta Physiologica Hungarica*: 207-218

- Ono, K., Delay, M., Makajme, T., Irisawe, H., Giles, W. (1989) Calcitonin-gene-related-peptides regulates calcium current in heart muscle. *Nature* 340:721-724
- Qiu, Y., Tang, X.L., Park, S.W., Sun, J.Z., Kalya, A., Bolli, R. (2001) The early and late phases of ischemic preconditioning: A comparative analysis of their effects on infarct size, myocardial stunning, and arrhythmias in conscious pigs undergoing a 40-minute coronary occlusion. *Circulation Research*. 997; 80:730–742.
- Quest, J.A., Diasi-Souza, J. N., Holton, J.R. (2004). Bronchial, cardiovascular and secretory responses after central administration of capsaicin in the guinea pig. *Naunyn-Schmiedeberg's Archives of Pharmacology*; 65-69
- Remphis, A., Scheffold, T., Karrer, O., Zehelein, J., Hamm, C., Grunig, E., Bode, C., Kubler, W., Katus, H.A. (1994) Assessment of reperfusion of the infarct zone after acute myocardial infarction by serial cardiac troponin T measurements in serum. *British Heart Journal*; 71:242–248.
- Schwarz, E.R., Somoano, Y., Hale, S.L. and Kloner, R.A. (2000). What is the required reperfusion period for assessment of myocardial infarct size using triphenyltetrazolium chloride staining in the rat? *Journal of Thrombosis and Thrombolysis* Springer Netherlands 2000:181-187.
- Sun, J.Z., Tang, X.L., Knowlton, A.A., Park, S.W., Qiu, Y., Bolli, R. (1995) Late preconditioning against myocardial stunning. An endogenous protective mechanism that confers resistance to postischemic dysfunction 24 h after brief ischemia in conscious pigs. *Journal Clinical Investigation*. 1995; 95: 388–403.

- Tunstall, J., Busselen, P., Rodrigo, G.C., Chapman, R.A. (1986) The calcium paradox of the heart. *Journal Molecular Cell Cardiology*; 18(3):241-254
- Weil, A. (1981) *Eating Chilies. The Marriage of the Sun and Moon*. Houghton Mifflin Company : 28-36.
- White, B.C., Winegar, C.D., Wilson, R.F., Krause, G.S. (1983) Calcium blockers in cerebral resuscitation. *Journal of Trauma*; 23(9):788-794
- Xue, B.J., He, R.R. (2000) Changes in heart rate, blood pressure and renal sympathetic nervous system activity induced by microinjection of capsaicin into area postrema in anesthetized Sprague-Dawley rats. *Sheng Li, Xue Bao*; 52(5):435-439.
- Yamashita, N., Hoshida, S., Taniguchi, N., Kuzuya, T., Hori, M.A. (1998) "Second window of protection" occurs 24 h after ischemic preconditioning in the rat heart. *Journal of Molecular Cell Cardiology*. ;30:1181–1189.
- Yang, X.M., Baxter, G.F., Heads, R.J., Yellon, D.M., Downey, J.M., Cohen, M.V. (1996) Infarct limitation of the second window of protection in a conscious rabbit model. *Cardiovascular Research*; 31: 777–783.

CHAPTER 9

CONCLUSION and RECOMMENDATIONS

Summary: This chapter assesses the extent to which the objectives of this study were achieved. Furthermore, it considers the inferences that could be drawn from the studies and then suggests whether the Null Hypothesis or the Alternative to Null Hypothesis is true. In line with the objectives laid out, studies were carried out to determine the analgesic, anti-inflammatory, coagulatory, gastrointestinal (GIT) and the cardiovascular effects of capsaicin.

9.1. ANALGESIC EFFECTS OF CAPSAICIN

The analgesic and behavioural effects of capsaicin were examined in mice. The ‘hot plate’ and the ‘acetic acid’ test methods showed *in vivo*, statistically significant analgesic effects. The main side-effect was transient episodes of hyperalgesia following intraperitoneal administrations of capsaicin. The capsaicin-induced hyperalgesia is consistent with the findings of Baumann (1991). This may be due to massive release of Substance P from its vesicles, followed by depletion. Consequently, depletion of Substance P results in analgesia. Therefore, it is recommended to inform patients of possible hyperalgesia, or to mix topical capsaicin cream with lignocaine or any other local anaesthetic, prior to its use. This study rejects the Null Hypothesis (i.e., that capsaicin has no analgesic effect) as false, and accepts the alternative to Null Hypothesis (i.e., that capsaicin has analgesic effect).

9.2. CAPSAICIN and INFLAMMATION

As earlier indicated, capsaicin has proved very useful in intractable pain of inflammatory origin, such as from osteoarthritis, pruritus, psoriasis, rheumatism, and complex regional pain syndrome (Winter *et al.*, 1995; Woolf, 1998; Yakish, 1999; Yoshimura *et al.*, 2000). This study has shown that capsaicin has anti-

inflammatory effect of statistical significance comparable to the anti-inflammation produced by diclofenac. This is due to inhibition of Substance P. In chronic inflammatory conditions, it was found that there is an associated up-regulation of Substance P receptors (De AK *et al.*, 1990); Velazquez *et al.*, 2002).

The present study accepts the alternative to Null Hypothesis, and rejects the Null hypothesis (i.e., that capsaicin has anti-inflammatory effects). In this sense, capsaicin and other vanilloid receptor agonists offer alternative analgesics and anti-inflammatory agents without the widespread side-effects of non-steroidal antiinflammatory drugs (NSAIDs) at clinical doses.

9.3. CAPSAICIN and BLOOD COAGULATION

The study on blood coagulation showed a dose-dependent increase in internationalised normalised ratio (INR), suggesting an increase in bleeding time and anticoagulation. This is consistent with the findings of Jaiarj, *et al.*, (1998). But unlike the latter, platelet adhesion was not increased. It could be inferred that the use of capsaicin or *Capsicum* could have a thromboprophylactic effect.

Furthermore, biochemical renal function did not change following chronic administration of capsaicin. This observation has not been reported before in the literature. As suggested earlier, the use of capsaicin in anticipated clotting problems, such as in long flights, could prove beneficial without the side-effects of clinical bleeding in the body, renal dysfunction, or GIT erosion as for NSAIDs.

9.4. CAPSAICIN and CARDIOVASCULAR SYSTEM

In this study, the effects of capsaicin on the heart rate, myocardial contractility, blood pressure, coronary perfusion, and coronary ischaemia-reperfusion injury were investigated. Earlier, a biphasic effect was reported on both the heart rate and the inotropic index (dp/dt).

Based on normal physiological function; and the blood pressure formula, reduction in coronary perfusion will lead to reduction in stroke volume from reduction in aortic root pressure.

Mean Arterial Pressure (MAP) = Cardiac Output (CO) x Total Peripheral Resistance (TPR),

This leads to reduction in the blood pressure. Previous studies showed that capsaicin leads to vasodilation and hypotension (Jaiarj, *et. al.*, 1998).

The reduction in inotropic index (dp/dt) following administration of capsaicin might depict a process of myocardial stunning or hibernation following treatment with capsaicin. The extent to which this phenomenal reduction in heart rate and contractility protects the heart requires further evaluation. Moreover, the post-ischaemia/reperfusion triphenyltetrazolium (TTC) stains showed only partial, statistically insignificant ($p>0.05$) myocardial preservation. These observations, have not been reported by other workers, and further studies will, therefore, be required.

9.5. SIDE EFFECTS

In this study, the notable side-effects of capsaicin as alluded to previously include hyperalgesia and irritation to the eyes up to corneal ulceration. Other side effects include sweating from vasodilataion, gastrointestinal erosion, and diarrhoea in high concentrations. It is important to re-design other capsaicin-related drugs that will be devoid of these side-effects, while preserving the potent analgesia, anti-inflammatory, anti-coagulatory as well as better cardiovascular profiles of capsaicin. Such available analogues include Olvanil (Breneman *et al.*, 1992); Nuvanil (Brand *et al.*, 1990), and Civamide, which are more potent than capsaicin, with better side-effect profiles (Hua *et al.*, 1997).

9.6. DRUG DESIGN

In order to design an acceptable analogue of capsaicin, it is essential to study the physico-chemical structure of currently related, agents to capsaicin, and determine which side-chain produces the undesirable side-effects, such as hyperalgesia. A re-designing of capsaicin will then be effected by removing the offending peptide or side-chain. In the same vein, nuvanil offers an alternative, more soluble and orally administered capsaicin analogue.

9.7. CONCLUSION

Capsaicin and its analogues constitute a class of agents with potential attributes to compete favourably with currently-available analgesic and anti-inflammatory drugs (Aasvang, 2009), and keenly compete with anticoagulant-antiplatelets without their undesirable side-effects. These potential benefits of capsaicin and its analogues might have been well observed ages ago. Capsaicin also showed calminative effects on GIT smooth muscles, as well as reduction of heart rate at low doses. This will be of benefit in borderline myocardial ischaemia by favouring oxygen supply over demand. Its anti-inflammatory effects might show promising effects in inflammatory bowel diseases.

9.8. RECOMMENDATIONS

CHROMATOGRAPHIC EXTRACTION

For now, this method of extraction appears to be the safest and cheapest method which can achieve up to 97-98% capsaicin as confirmed by Nuclear Magnetic Resonance. Further work has to be done to prove whether or not it is on a commercial scale. Chromatography will remain the best option.

NEUROPHARMACOLOGICAL AND ANTINFLAMMATORY STUDIES

The temperature of the analgesiometer needs standard control at 40 °C. It is also essential to standardise the period of the day during which the studies are carried out in order to reduce the effects of diurnal variation on the physiology of the animals.

CAPSAICIN and MUSCLES

In the light of the results obtained from the present study, it is recommended that more elaborate human studies in the use of capsaicin in inflammatory bowel disease, colonic cancers, which hitherto had been incurative, be carried out. Also the use of homeopathic doses of capsaicin in heart rate control and cardioprotection should be investigated.

CAPSAICIN and ANTICOAGULATION

There is confounding evidence resulting from this study to show that capsaicin has a role in anticoagulation pathway. But further questions need to be asked, including the direct or indirect effects of capsaicin on platelets, clotting factors and the vessels. Further work will have to be done to clear these grey areas.

Since this study was not aimed to compare capsaicin with the new vanilloid agonists, further studies are needed to establish if these vanilloid agonists will be more suitable analgesics, anti-inflammatory, anticoagulant, cardiac and gastrointestinal agents on account of efficacy and side-effect profiles.

9.9. REFERENCES

- Aasvang, E.K. Hansen, J.B. Malmstrom, J. Asmussen, T. Gennevois, D. Struys, M.M. Kehlet, H. (2009) The effect of wound instillation of a novel purified capsaicin formulation on postherniotomy pain: a double-blind, randomized, placebo-controlled study. *Anesthesia Analgesia*; 107 (1):9-10
- Baumann, T.K. Simone, D.A. Shn, C.N. and LaMotte, R.H. (1991). Neurogenic hyperalgesia: The search for the primary cutaneous afferent fibers that contribute to capsaicin-induced pain and hyperalgesia. *Journal of Neurophysiology*; 66(1): 212-227.
- Brand, L.M. Skare, K.I. Loomans, M.E. Reller, H.H. Schwen, R.J. Lade, D.A. Bohne, R.L. Maddin, C.S. Moorehead, D.P. Fanelli, R. Chiabrando, C. Castelli, M.G. and Tai, H.H. (1990). Anti-inflammatory pharmacology and mechanism of the orally active capsaicin analogs, NE-19950 and NE-28345. *Agents and Clinical Research*; 31: 329-340.
- Breneman, D.L. Cardone, J.S. Blumack, R.F. Lather, R.M. Searle, E.A. and Pollack, V.E. (1992). Topical capsaicin treatment of hemodialysis-related pruritus. *Journal of the American Academy of Dermatology*; 26: 91-94.
- Castagliuolo, I. Keates, A.C. Qiu, B. Kelly, C.P. Nikulasson, S. Leeman, S.E. and Pothoulakis, C. (1997). Increased Substance P responses in dorsal root ganglia and intestinal macrophages during clostridium difficile toxin A enteritis in rats. *Proceedings of National Academy of Sciences U S A*; 29; 94(9):4788-93.
- De, A.K. and Ghosh, J.J. (1990). Inflammatory responses induced by Substance P in rat paw. *Indian Journal of Experimental Biology*; 28 (10): 946-948.
- Donnerer, J. Bartho, L. Holzer, P. and Lembeck, F. (1984). Intestinal peristalsis associated with release of Substance P. *Neuroscience*; 11: 913-918.

- Holzer, P. (1991). Capsaicin: Cellular targets, mechanisms of action, and selectivity for thin sensory neurons. *Pharmacological Reviews*; 43: 143-201.
- Hua, X.Y. Chen, P. Hwang, J. and Yaksh, T.L. (1997). Antinociception induced by civamide: An orally active Capsaicin analogue. *Pain*; 71 (3): 313-322.
- Jaiarj, P. Saichompoo, S. Wongkrajang, Y. Vongswan, N. Peungvicha, P. and Jiratchariyakul, W. (1998). Cardiovascular actions of capsaicinoids extract from Thai capsicum. *Thai Journal of phytopharmacy*; 5(2): 1-13.
- Mantyh, C.R. Gates, T.S. Zimmerman, R.P. Welton, M.L. Passaro, E.P. Jr. Vigna, S.R. Maggio, J.E. Kruger, L. and Mantyh, P.W. (1988). Receptor binding sites for Substance P, but not substance K or neuromedin K, are expressed in high concentrations by arterioles, venules, and lymph nodules in surgical specimens obtained from patients with ulcerative colitis and Crohn disease. *Proceedures of National Academy of Science U S A*; 85(9): 3235-9.
- McCafferty, D.M. Sharkey, K.A. and Wallace, J.L. (1994). Beneficial effects of local or systemic lidocaine in experimental colitis. *American Journal of Physiology*; 266: G560-567).
- Otsuka, M. and Yoshioka, K. (1993). Neurotransmitter functions of mammalian tachykinins. *Physiology Reviews*; 73: 229-308.
- Pothoulakis, C. Castagliuolo, I. LaMont, J.T. Jaffer, A. O'Keane, J.C. Snider, R.M. and Leeman, S.E. (1994). CP-96,345, a Substance P antagonist, inhibits rat intestinal responses to clostridium difficile toxin A but not cholera toxin. *Proceedures of National Academy of Science U S A*; 91 (3): 947.
- Velaquez, R.A. McCarson, K.E. Cai, Y. Kovacs, K.J. Shi, Q. Evensjo, M. and Larson, A.A. (2002). *European Journal of NeuroScience*; 16 (2): 229-241.

- Winter, J. Bevan, S. and Campbell, EA. (1995). Capsaicin and pain mechanisms; *British Journal of Anaesthesia*; 75: 157-168.
- Woolf, C.J. Bennett, G.J. Doherty, M. Dubner, R. Kidd, B. Koltzenburg, M. Lipton R. Loeser, J.D. Payne, R. and Torcbjork, E (1998). Towards a mechanism-based classification of pain? *Pain*; 77: 227-229.
- Yakish, T.L. (1999). Spinal systems and pain processing: Development of novel analgesic drugs with mechanistically defined models. *Trends Pharmacological Science*; 20: 329-337
- Yoshimura, M. Yonehara, N. Ito, T. Kawai, Y. and Tamura, T. (2000). Effects of topically applied capsaicin cream on neurogenic inflammation and thermal sensitivity in rats. *Journal of the Peripheral Nervous System*. ; 5 (2): 116-117.

APPENDIX 1

Publications from Study

(I) Peer reviewed Journals

1. Jolayemi A.T. (2007) Analgesic effects of capsaicin in witstar rats is superior to morphine or diclofenac. *Regional Anaesthesia and Pain Medicine*; 32 (5):324-324.
2. Jolayemi A.T. (2008) Cross-talk between the vanilloid and cholinergic receptors in guinea-pig ileum. Is capsaicin a partial cholinergic agonist? *Anaesthesia and Intensive Care*; 36 (4):596-596.

(II) Abstracts and Posters to International Congresses

Jolayemi A. T. Posters and Abstracts to World Congress of Anaesthesia (Feb 29-March 02 2007)

Pain

Anti-inflammatory effects of capsaicin in Witstar rats-a need for review of definition of non steroidal, anti-inflammatory agents

Adebayo T Jolayemi

Department of Anaesthesia, Portland Hospital Victoria State Australia

The anti-inflammatory property of Capsaicin (CPF) and *Capsicum frutescens* Linn. [Solanaceae] aqueous fruit extract (CFE) in rabbits.

Sixty rats 250-300 g were divided into 4 groups. Group A was the control (2 ml of 0.9 % saline) and group B consisted of 10 rats that received i.p. diclofenac (100 mg/kg) as the positive control. Pre-procedural general anaesthesia was established using .25 ml each of hypnoval (midazolam) and anaket (ketamine) i.m. followed by baseline measurements of the circumference of both the right and left feet. Inflammation was induced in rats' hind paw following sub-plantar injection of albumin with 0.5-ml/kg fresh egg albumin. The circumference of the right fore paw was repeatedly measured in time intervals of ½, 1, 2, 4, and 12 hours respectively. The blood levels of C reactive protein and Cortisol were also measured. Data obtained were pooled and analysed using repeated ANOVA, in a general linear model with the CPSS software.

Compared to the diclofenac (DIC) group, the degree of inhibition of paw oedema by ethyl acetate extract of *Capsicum frutescens* Linn. [Solanaceae] and synthetic capsaicin (Fluka-biotechnika) was statistically significant ($P < 0.05 > 0.0001$). The

reduction of morning corticosterone levels in the extract or capsaicin pre-treated compared to the control animals was statistically significant ($p < 0.015$). The C - reactive protein levels were significantly 10 times higher in the treated samples showing an immune response to the phlogistic agents.

Capsaicin in this study shows an anti-inflammatory property reaching a peak level at 4 hours following administration.

1. Capsaicin study group. (1999). Treatment of painful diabetic neuropathy with topical capsaicin. A multi-centre, double blind, vehicle-controlled study. *Archives of Internal Medicine*, 151:2225-2229.
2. Carpenter S E, Lynn B. (1981) Vascular and sensory responses of human skin to mild injury after topical treatment with capsaicin. *British Journal of Pharmacology*, 73:755-758.

Pharmacology

Cardiovascular effects of Capsaicin Laggendorffs rat heart models

Adebayo T Jolayemi

Department of Anaesthesia; Portland Hospital; Victoria Australia

The aim of this study is to investigate the effects of capsaicin on the heart rate and myocardial contractility and the coronary perfusion.

Six rat hearts were prepared and treated using a 50 ml Laggendorffs Apparatus. Seven doses (0.05, 0.1, 0.2, 0.4, 0.6, 0.8 and 1.0 mcg/ml) were administered respectively.

The results show a dose-dependent increase in the heart rate from a dose of 0.05 mcg/ml up to a dose of 0.3mcg/ml CAPs at $P < 0.001$, (probably from the release of tachykinins with Calcium as the secondary messenger). This was followed by a dose-dependent bradycardia at higher doses from a dose of 0.3- 1 mcg/ml at $P < 0.001$., probably from the release of Magnesium ions. Possible evidence of cross-talk between Capsaicin-activated vanilloid receptors and Calcitonin related gene peptides system could be inferred. The (dp/dt) were computed and analysed. The result shows a dose dependent reduction in the left ventricular contraction within a dose range of 0.05-1 mcg/ml at $P < 0.001$.The coronary perfusion pressure dropped by 67 % from a non-treated to a dose of 0.05mcg/ml. Thereafter the CPP dropped inconsistently by 4-8 % between each dose treatments from 0.1-1 mcg/ml. This may infer a tendency for coronary dilatation and consequently on the mean arterial blood pressure. Statistical analysis was done using Graph prism pad software and the Microsoft excel.

Capsaicin had shown biphasic effects on the heart rate. The dose dependent reduction in the contractility, heart rate and the coronary perfusion supports a tendency for hypotension as alluded to by earlier workers.

1. MALINOWSKA B., KWOLEK G. & GOTHERT M. (2001) Anandamide and methanandamide induce both vanilloid VR1- and cannabinoid CB1 receptor-mediated changes in heart rate and blood pressure in anaesthetized rats. *Nauyn-Schmiedebergs Arch. Pharmacol.* 364: 562-569

Coagulation

The effects of Capsaicin on coagulation and renal function

Adebayo T Jolayemi

Department of Anaesthesia, Portland City, Victoria State Australia

The aim of this study to investigate the effects of capsaicin and *Capsicum frutescens* LINN. [SOLANACEAE] aqueous fruit extract of South African origin on coagulation and renal function in Witstar rats.

Experimental design was a double-blind, placebo-controlled, parallel study. Witstar rats weighing 250–300 g were divided into two groups A (n=12) and B. Group B consisted of 3 treatment groups of 12 animals per group. They had similar demographics and kept under standard laboratory care. The animals received 2.5, 5.0, or 10.0 mg/kg i.p.i respectively. Following treatment, 1.5-2 cc blood was collected by intracardiac puncture following deep ether anaesthesia. The blood specimen were analysed for serum urea, creatinine, platelets, as well as the INR (internationalised normalised ratio).

The result shows dose-dependent increase in INR in the groups compared to the control. There mean INR of 1 ± 0.1 , 1.4 ± 0.1 and 2.0 ± 0.3 respectively for the treatment groups of 2.5, 5.0 and 10 mg/kg was statistically significant ($P<0.05$). The platelets count, serum urea and creatinine levels were essentially normal. Figure1: shows dose-dependent increase in INR from 5-10 mg/kg i.p.i.capsaicin. This study shows that capsaicin has dose-dependent effects on the INR and not on the platelets. Unlike the earlier report by Jaiarj et. al. (1998) which shows that capsaicin has antithrombotic effects, this study shows that the anti thrombotic effect of capsaicin is related to its effects on the common or the extrinsic pathway rather than any antiplatelet activity.

In clinical doses, Capsaicin has antithrombotic but no nephrotoxic effects.

Jaiarj P, Saichompoo S, Wongkrajang Y, Vongswan N, Peungvicha P, Jiratchariyakul W (1998) Cardiovascular actions of capsaicinoids extract from Thai capsicum *Thai Journal of phytopharmacy*, 5(2):1-13.

Vascular anaesthesia

Capsaicin effects on myocardial ischaemic reperfusion in Witstar rat using Laggendorff's heart model.I

Adebayo T Jolayemi

Department of Anaesthesia, Portland Hospital, Victoria, Australia

The aim of the study is to investigate the effects of capsaicin on myocardial ischaemic reperfusion injury

Six rat hearts were prepared and treated using 0.05-1 mcg/ml in a 50 ml Laggendorffs Apparatus. The ECG, heart rate, coronary perfusion and the dp/dt were monitored during the treatments. Following treatments with 0.05, 0.1, 0.2, 0.4, 0.6, 0.8 and 1.0 mcg/ml Capsaicin, the hearts were exposed to 30 min ischaemia followed by 60 min reperfusion. The hearts were then treated with 1% triphenyltetrazolium chloride (TTC). Histopathological slides of the heart were prepared and examined for evidence of ischaemia and or infarction. The results were compared with the control.

The result shows an infarction rate of between 10-100% in the sections. The ventricles were more affected with ischaemia-infarction compared to the atria, base or the apex of the heart. In 33 % of the studied heart sections, the degree of global infarction was less than 20 %. The infarction of the ventricles was 95-100% in 50% of the slides. The correlation between right and left ventricular reperfusion injury was 1 at $p < 0.0001$.

Although certain areas of the heart were spared of myocardial ischaemic-reperfusion injury, further work is needed to establish the role of capsaicin as a cardio-protective agent in ischaemic-reperfusion injury.

Xue BJ, He RR (2000) Changes in heart rate, blood pressure and renal sympathetic nervous system activity induced by microinjection of capsaicin into area postrema in anesthetized Sprague-Dawley rats. Sheng Li, Xue Bao, 52(5):435-439.

(III) **Publications submitted to ISI-recognized or SAPSE-rated journals**

Central and peripheral analgesic effects of *Capsicum frutescens* LINN. [SOLANACEAE] aqueous fruit extract and capsaicin in mice is comparable to analgesia by Morphine and superior to analgesia by Diclofenac.

A. T. Jolayemi^{a*} J. A. O. Ojewole^b

Anti-inflammatory effects of *Capsicum frutescens* Linn [Solanaceae] aqueous fruit extract in rats

A. T. Jolayemi^{a*} J. A. O. Ojewole^b

Capsaicin, its potential medicinal uses, and side effects

A. T. Jolayemi^{a*} J. A. O. Ojewole^b

The effects of capsaicin on coagulation

A. T. Jolayemi^{a*} J. A. O. Ojewole^b

Capsaicin effects on myocardial ischaemic reperfusion injury in Wistar rat using Laggendorffs heart model

A. T. Jolayemi^{a*} J. A. O. Ojewole^b

Effects of capsaicin on the cardiovascular function in isolated rat hearts using Laggendorff's heart preparation

A. T. Jolayemi^{a*} J. A. O. Ojewole^b

Peri operative uses of capsaicin

A. T. Jolayemi^{a*} J. A. O. Ojewole^b

Pharmacological effects of capsaicin on gastrointestinal smooth muscles

A. T. Jolayemi^{a*} J. A. O. Ojewole^b

Appendix II

Equipments used in the Study



Figure A.1. Giant conical Pyrex bottle containing insoluble mass of *Capsicum* after filtration.



Figure A.2. Simple Liquid Chromatography set-up



Figure A.3. low heat of DCA-primed insoluble mass to extract capsaicinoids.



Figure A.4. Fumes Chamber to reduce atmospheric pollution of the Laboratory



Figure A. 5. Hot Plate Analgesimeter

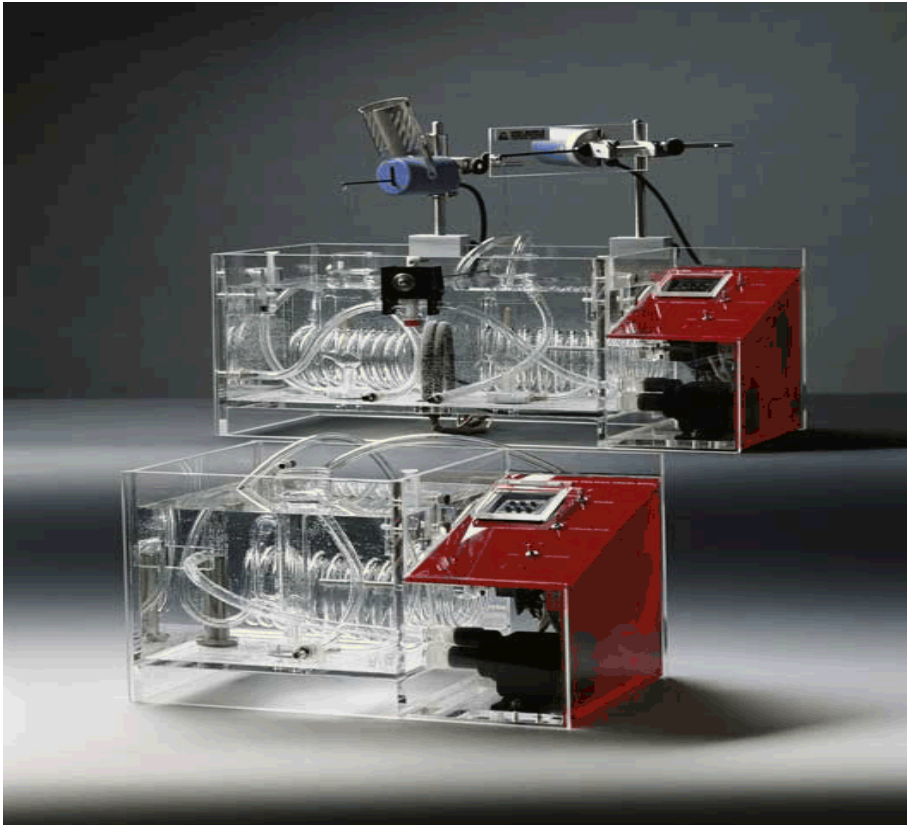

Figure A. 6. Ugo-Baseille Twin Chamber with and without mounted forced displacement transducer

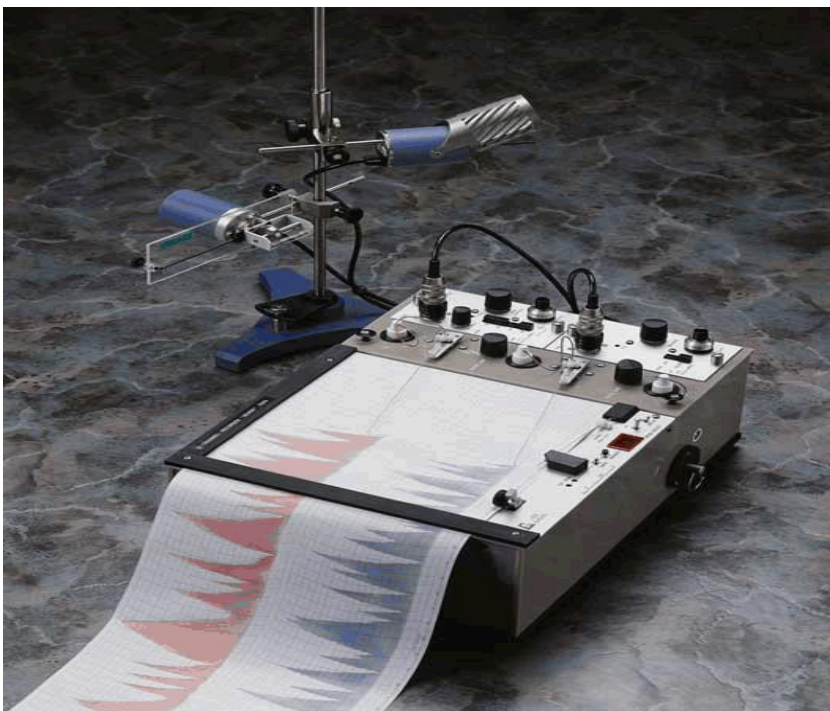

Figure A. 7. Gemini 7070 Recorder in action

Appendix II b –AD Equipments for Laggendorff’s Isolated Heart Experiments



Figure A.8. Minipuls 3 peristaltic pump



Figure A. 09. Lagendorff Apparatus and Thermostat Controller



Figure A. 10. STH Pump Controller

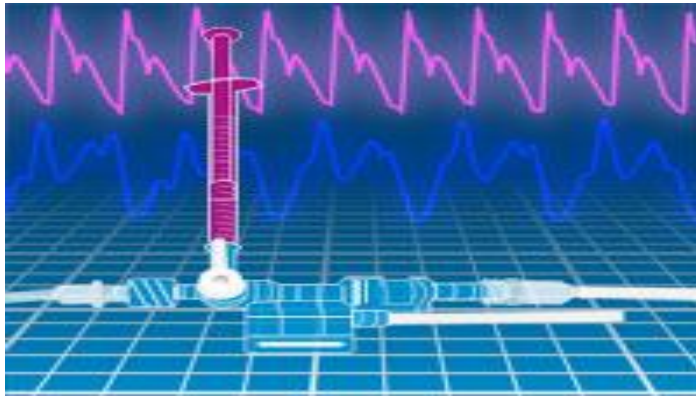

Figure A. 11. Atrial and Ventricular Pressure Monitor and Transducer.

PowerLab for Data acquisition Set-up

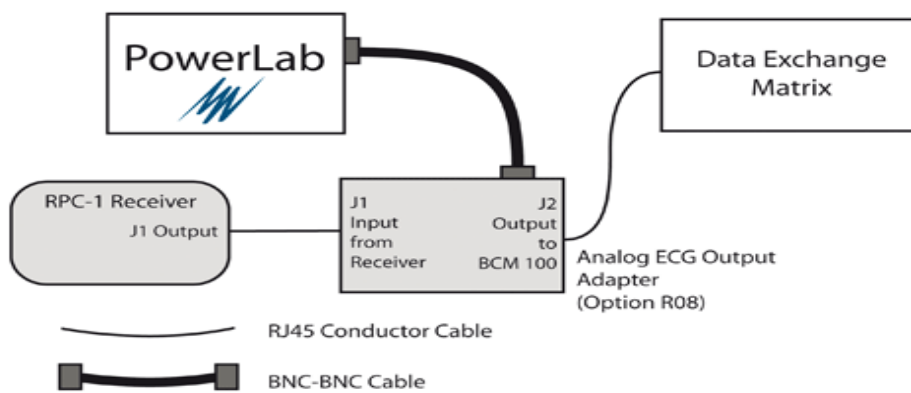

Figure A. 12. Above: Example equipment set-up for acquiring an ECG signal to both a Data Exchange Matrix and acquisition



Figure A. 13. Powerlab Chart



Figure A. 14. Set-up for preparing Krebs's Cycle

Appendix III

Dissected Animals



Figure A.15. Guinea-pig.



Figure A.16. Day-old chick



Figure A.17. Dissected guinea-pig intestine



Figure A.18. Dissected rabbit



Figure A. 19. Rat dissected to harvest both the heart and intestine

Appendix IV

Experimental Set-ups

Set-up for GIT Experiments



Figure A.20. Showing set-up for Ugo Baseille Organ twin-bath and Recorder.

Isolated Heart Muscle Experiments



Figure A.21. Langendorff constant pressure non-recirculating

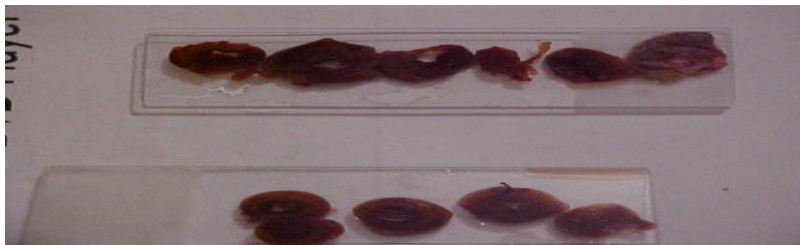

Figure A. 22. Showing some histology slides of TTC stained reperused rats heart muscles

Appendix V- Experimental Data (Mean values shown in n=10)

Table A.5.1a. Concentration-response of ACh ($\mu\text{g/ml}$) with and without fixed doses of capsaicin in chick oesophagus.

Dose ACh	ACh	ACh + 20 $\mu\text{g/ml}$	
		CPF	ACh + 40 $\mu\text{g/ml}$ CPF
5	3	2	1
10	9	3	1
20	26	8	2
40	33	15	8
60	42	20	12
80	54	30	14
160	70	35	16

Table A.5.1b. % maximal contraction of chick oesophagus to ACh ($\mu\text{g/ml}$) with and without fixed doses of CPF.

Dose ACh	ACh	ACh + 20 $\mu\text{g/ml}$ CPF	ACh + 40 $\mu\text{g/ml}$ CPF
5	4.5	3	1
10	12.5	4.5	2
20	30	15	8
40	48	30	26
60	60	48	45
80	80	55	35
160	100	50	20

Table A.5.2a. Concentration-response of ACh ($\mu\text{g/ml}$) with and without fixed doses of CPF in isolated rabbit duodenum.

Dose ACh	ACh	ACh + 20 $\mu\text{g/ml}$ CPF	ACh + 40 $\mu\text{g/ml}$ CPF
5	0	0	0
10	10	3	1
20	22	7	3
40	34	11	4.5

60	40	12	5
80	53	13	7
160	65	18	12

Table A.5.2b. % maximal contraction of rabbit duodenum to ACh ($\mu\text{g/ml}$) with and without fixed doses of CPF.

Dose ACh	ACh + 20 $\mu\text{g/ml}$		
	ACh	CPF	ACh + 40 $\mu\text{g/ml}$ CPF
5	0	0	0
10	15	5	2
20	34	11	5
40	53	17	7
60	63	18.5	8
80	82	20	11
160	100	27	18.5

Table A.5.3a. Concentration-response of ACh ($\mu\text{g/ml}$) with and without fixed doses of CPF in isolated guinea-pig ileum.

Dose ACh	ACh alone	ACh + 40 $\mu\text{g/ml}$	
		ACh + 20 $\mu\text{g/ml}$ CPF	CPF
5	0	0	0
10	2	1.2	2
20	8	4	2
40	20	12	5
60	35	14	14
80	58	29	24
160	72	50	24

Table A.5.3b. % maximal contraction of isolated guinea-pig ileum to ACh ($\mu\text{g/ml}$) with and without fixed doses of CPF.

Dose ACh	ACh	ACh + 20 µg/ml	
		CPF	ACh + 40 µg/ml CPF
5	0	0	0
10	3	2	2
20	11	6	3
40	28	17	7
60	49	19	19
80	81	40	33
160	100	70	33

Table A.5.4. Concentration-response of capsaicin (CPF) (µg/ml) with or without fixed doses of Atropine (ATR) and the percentage inhibition of contraction in isolated guinea-pig ileum.

Dose CPF	CPF + ATR	CPF + ATR	%age inhibition
5	0	0	0
10	6	1.5	75
20	7	2.5	70
40	8	3	62.5
60	10.5	4	58
80	25	22	12

Table A.5.5. Concentration-response of capsaicin (CPF) (µg/ml) with or without fixed doses of ondasetron in isolated guinea-pig ileum shows no predictable interaction.

Dose	CPF	CPF + OND
------	-----	-----------

5	1	20
10	5	1
20	5	4
40	8	6
80	14	2.5

Table A.5.6. Mean heart rate response to six treatments of CPF (0.05-1µg/ml)

<i>Control</i>	<i>T1</i>	<i>T2</i>	<i>T3</i>	<i>T4</i>	<i>T5</i>	<i>T6</i>
166	162	448	305	286	116	70
132	137	373	405	188	36	50
115	305	295	444	96	70	11
126	125	113	77	96	23	10
135	182	307	308	167	61	35
134	165	287	375	203	87	26

Appendix VI

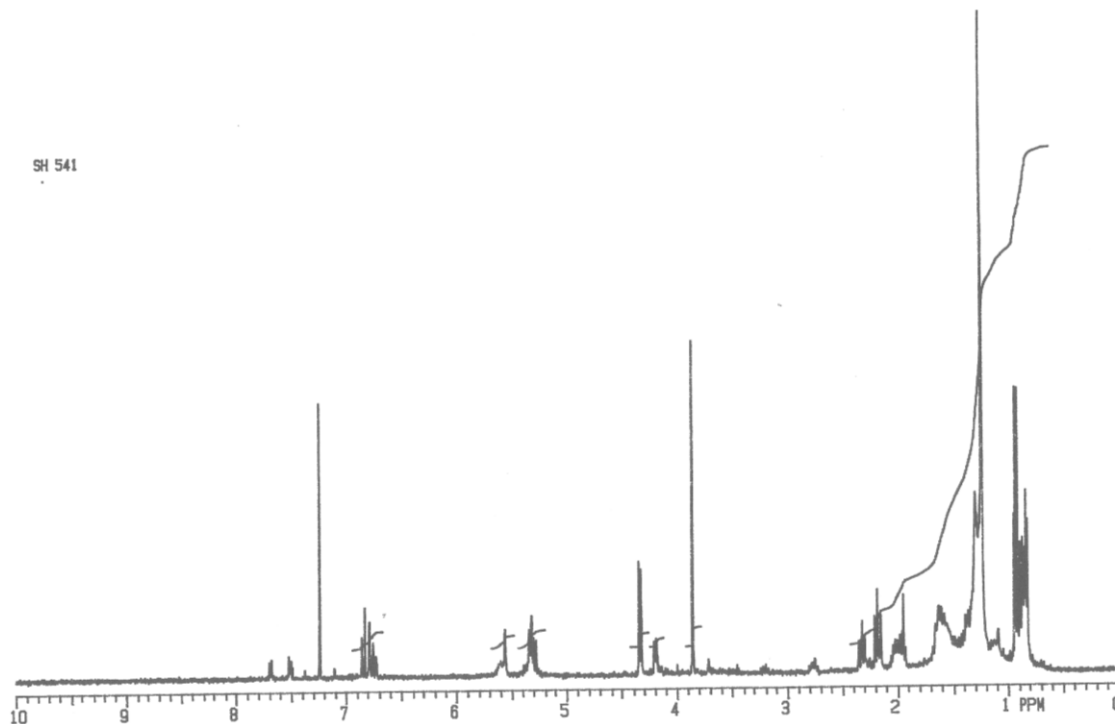

NMR profile of capsaicin-courtesy of Prof Shode, Department of Organic Chemistry UKZN/2005

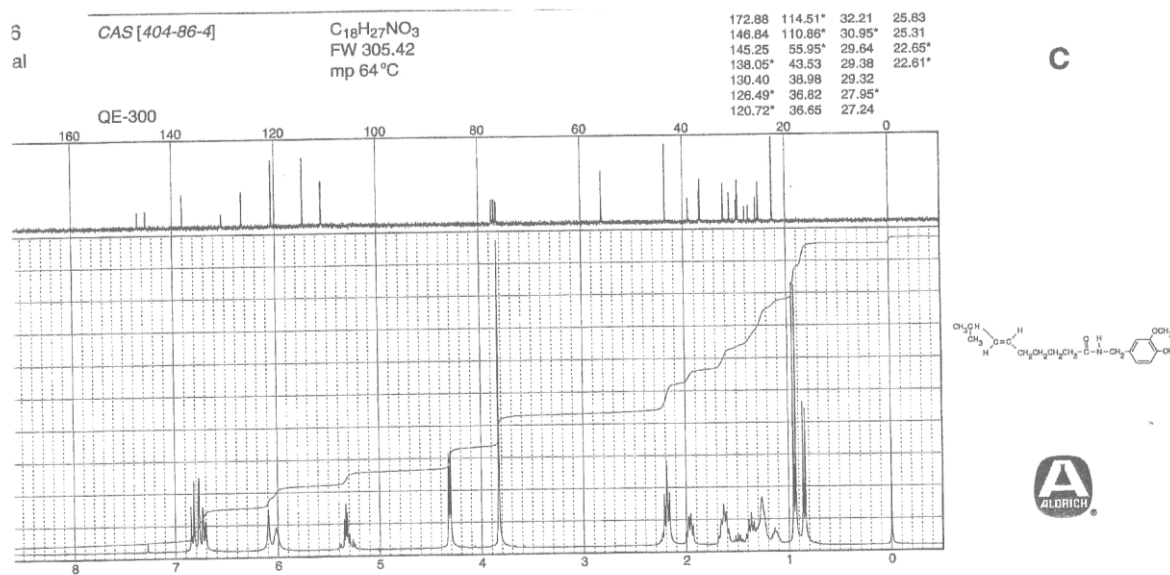

Figure A.VI.1. Nuclear Magnetic Resonance Identification of capsaicin- courtesy of Prof. Francis O. Shode and Department of Organic Chemistry UKZN/2005.

Appendix VI I

SI Units for Clinical Data (as advised by JAMA Journal of American Medical Association to Authors).

The following table provides factors for converting conventional units to SI units for selected clinical data. Source:

Conversion: to convert from the conventional unit to the SI unit, **multiply** by the conversion factor; to convert from the SI unit to the conventional unit, **divide** by the conversion factor.

Component	Conventional Unit	Conversion Factor	SI Unit
Acetaminophen	µg/mL	6.62	µmol/L
Acetoacetic acid	mg/dL	0.098	mmol/L
Acetone	mg/dL	0.172	mmol/L
Acid phosphatase	units/L	1.0	U/L
Alanine	mg/dL	112.2	µmol/L
Alanine aminotransferase (ALT)	units/L	1.0	U/L
Albumin	g/dL	10	g/L
Alcohol dehydrogenase	units/L	1.0	U/L
Aldolase	units/L	1.0	U/L
Aldosterone	ng/dL	0.0277	nmol/L
Alkaline phosphatase	units/L	1.0	U/L
Aluminum	ng/mL	0.0371	µmol/L
Aminobutyric acid	mg/dL	97	µmol/L
Amitriptyline	ng/mL	3.61	nmol/L
Ammonia (as NH ₃)	µg/dL	0.587	µmol/L
Amylase	units/L	1.0	U/L
Androstenedione	ng/dL	0.0349	nmol/L
Angiotensin I	pg/mL	0.772	pmol/L
Angiotensin II	pg/mL	0.957	pmol/L
Anion gap	mEq/L	1.0	mmol/L
Antidiuretic hormone	pg/mL	0.923	pmol/L
Antithrombin III	mg/dL	10	mg/L
alpha ₁ -Antitrypsin	mg/dL	0.184	µmol/L
Apolipoprotein A	mg/dL	0.01	g/L
Apolipoprotein B	mg/dL	0.01	g/L
Arginine	mg/dL	57.4	µmol/L
Asparagine	mg/dL	75.7	µmol/L
Aspartate aminotransferase (AST)	units/L	1.0	U/L
Bicarbonate	mEq/L	1.0	mmol/L
Bilirubin	mg/dL	17.1	µmol/L
Blood gases (arterial)			

Paco ₂	mm Hg	1.0	mm Hg
pH	pH units	1.0	pH units
Pao ₂	mm Hg	1.0	mm Hg
Bromide	mg/dL	0.125	mmol/L
C-peptide	ng/mL	0.333	nmol/L
C1 esterase inhibitor	mg/dL	10	mg/L
C3 complement	mg/dL	0.01	g/L
C4 complement	mg/dL	0.01	g/L
Calcitonin	pg/mL	1.0	ng/L
Calcium	mg/dL	0.25	mmol/L
	mEq/L	0.50	mmol/L
Carbon dioxide	mEq/L	1.0	mmol/L
Carboxyhemoglobin	% of hemoglobin saturation	0.01	Proportion hemoglobin
Carotene	µg/dL	0.0186	µmol/L
Ceruloplasmin	mg/dL	10	mg/L
Chloride	mEq/L	1.0	mmol/L
Cholesterol	mg/dL	0.0259	mmol/L
Citrate	mg/dL	52.05	µmol/L
Copper	µg/dL	0.157	µmol/L
Coproporphyrins (urine)	µg/24 hr	1.527	nmol/d
Corticotropin (ACTH)	pg/mL	0.22	pmol/L
Cortisol	µg/dL	27.59	nmol/L
Cotinine	ng/mL	5.68	nmol/L
Creatine	mg/dL	76.26	µmol/L
Creatine kinase (CK)	units/L	1.0	U/L
Creatinine	mg/dL	88.4	µmol/L
Creatinine clearance	mL/min	0.0167	mL/s
Cyanide	mg/L	23.24	µmol/L
Dehydroepiandrosterone (DHEA)	ng/mL	3.47	nmol/L
Desipramine	ng/mL	3.75	nmol/L
Diazepam	µg/mL	3.512	µmol/L
Digoxin	ng/mL	1.281	nmol/L
Epinephrine	pg/mL	5.46	pmol/L
Erythrocyte sedimentation rate	mm/h	1.0	mm/h
Estradiol	pg/mL	3.671	pmol/L
Estriol	ng/mL	3.467	nmol/L
Estrone	ng/dL	37	pmol/L
Ethanol (ethyl alcohol)	mg/dL	0.217	mmol/L
Ethylene glycol	mg/L	16.11	µmol/L
Ferritin	ng/mL	2.247	pmol/L
alpha -Fetoprotein	ng/mL	1.0	µg/L
Fibrinogen	mg/dL	0.0294	µmol/L
Fluoride	µg/mL	52.6	µmol/L
Folate	ng/mL	2.266	nmol/L

Follicle-stimulating hormone	mIU/mL	1.0	IU/L
Fructose	mg/dL	55.5	µmol/L
Galactose	mg/dL	55.506	µmol/L
Glucagon	pg/mL	1.0	ng/L
Glucose	mg/dL	0.0555	mmol/L
Glutamine	mg/dL	68.42	µmol/L
gamma -Glutamyltransferase (GGT)	units/L	1.0	U/L
Glycated hemoglobin (glycosylated hemoglobin A _{1c} , A _{1c})	% of total hemoglobin	0.01	Proportion of hemoglobin
Glycerol (free)	mg/dL	108.59	µmol/L
Glycine	mg/dL	133.3	µmol/L
Haptoglobin	mg/dL	0.10	µmol/L
Hematocrit	%	0.01	Proportion of 1.0
Hemoglobin (whole blood)	g/dL	10.0	g/L
Mass concentration		0.6206	mmol/L
High-density lipoprotein cholesterol (HDL-C)	mg/dL	0.0259	mmol/L
Histidine	mg/dL	64.45	µmol/L
Homocysteine (total)	mg/L	7.397	µmol/L
Human chorionic gonadotropin (HCG)	mIU/mL	1.0	IU/L
Hydroxybutyric acid	mg/dL	96.05	µmol/L
Hydroxyproline	mg/dL	76.3	µmol/L
Immunoglobulin A (IgA)	mg/dL	0.01	g/L
Immunoglobulin D (IgD)	mg/dL	10	mg/L
Immunoglobulin E (IgE)	mg/dL	10	mg/L
Immunoglobulin G (IgG)	mg/dL	0.01	g/L
Immunoglobulin M (IgM)	mg/dL	0.01	g/L
Insulin	µIU/mL	6.945	pmol/L
Iron, total	µg/dL	0.179	µmol/L
Iron binding capacity, total	µg/dL	0.179	µmol/L
Isoleucine	mg/dL	76.24	µmol/L
Isopropanol	mg/L	0.0166	mmol/L
Lactate (lactic acid)	mg/dL	0.111	mmol/L
Lactate dehydrogenase	units/L	1	U/L
Lactate dehydrogenase isoenzymes (LD ₁ -LD ₅)	%	0.01	Proportion
Lead	µg/dL	0.0483	µmol/L
Leucine	mg/dL	76.237	µmol/L
Lipase	units/L	1.0	U/L
Lipids (total)	mg/dL	0.01	g/L
Lipoprotein (a)	mg/dL	0.0357	µmol/L
Lithium	mEq/L	1.0	mmol/L
Low-density lipoprotein cholesterol (LDL-C)	mg/dL	0.0259	mmol/L
Luteinizing hormone (LH, leutropin)	IU/L	1.0	IU/L

Lysine	mg/dL	68.5	μmol/L
Magnesium	mg/dL	0.411	mmol/L
	mEq/L	0.50	mmol/L
Manganese	ng/mL	18.2	nmol/L
Methanol	mg/L	0.0312	mmol/L
Methemoglobin	% of total hemoglobin	0.01	Proportion of hemoglobin
Methionine	mg/dL	67.02	μmol/L
Myoglobin	μg/L	0.0571	nmol/L
Nicotine	mg/L	6.164	μmol/L
Nitrogen, nonprotein	mg/dL	0.714	mmol/L
Norepinephrine	pg/mL	0.00591	nmol/L
Ornithine	mg/dL	75.67	μmol/L
Osmolality	mOsm/kg	1.0	mmol/kg
Osteocalcin	μg/L	0.171	nmol/L
Oxalate	mg/L	11.1	μmol/L
Parathyroid hormone	pg/mL	1.0	ng/L
Phenobarbital	mg/L	4.31	μmol/L
Phenylalanine	mg/dL	60.54	μmol/L
Phenytoin	μg/mL	3.96	μmol/L
Phosphorus	mg/dL	0.323	mmol/L
Plasminogen	mg/dL	0.113	μmol/L
	%	0.01	Proportion of 1.0
Plasminogen activator inhibitor	mIU/mL	1.0	IU/L
Platelets (thrombocytes)	$\times 10^3/\mu\text{L}$	1.0	$\times 10^9/\text{L}$
Potassium	mEq/L	1.0	mmol/L
Pregnanediol (urine)	mg/24h	3.12	μmol/d
Pregnanetriol (urine)	mg/24 h	2.97	μmol/d
Progesterone	ng/mL	3.18	nmol/L
Prolactin	μg/L	43.478	pmol
Proline	mg/dL	86.86	μmol/L
Prostate-specific antigen	ng/mL	1.0	μg/L
Protein, total	g/dL	10.0	g/L
Prothrombin	g/L	13.889	μmol/L
Prothrombin time (protime, PT)	s	1.0	s
Protoporphyrin, erythrocyte	μg/dL	0.01777	μmol/L
Pyruvate	mg/dL	113.6	μmol/L
Quinidine	μg/mL	3.08	μmol/L
Red blood cell count	$\times 10^6/\mu\text{L}$	1.0	$\times 10^{12}/\text{L}$
Renin	pg/mL	0.0237	pmol/L
Reticulocyte count	% of RBCs	0.01	Proportion of 1.0
Salicylate	mg/L	0.00724	mmol/L
Serine	mg/dL	95.2	μmol/L
Serotonin (5-hydroxytryptamine)	ng/mL	0.00568	μmol/L
Sodium	mEq/L	1.0	mmol/L

Somatomedin-C (insulinlike growth factor)	ng/mL	0.131	mol/L (factor II)
Somatostatin	pg/mL	0.611	pmol/L
Taurine	mg/dL	79.91	μmol/L
Testosterone	ng/dL	0.0347	nmol/L
Theophylline	μg/mL	5.55	μmol/L
Thiocyanate	mg/L	17.2	μmol/L
Threonine	mg/dL	83.95	μmol/L
Thyroglobulin	ng/mL	1.0	μg/L
Thyrotropin (thyroid-stimulating hormone, TSH)	mIU/L	1.0	mIU/L
Thyroxine, free (T ₄)	ng/dL	12.87	pmol/L
Thyroxine, total (T ₄)	μg/dL	12.87	nmol/L
Transferrin	mg/dL	0.01	g/L
Triglycerides	mg/dL	0.0113	mmol/L
Triiodothyronine			
Free (T ₃)	pg/dL	0.0154	pmol/L
Resin uptake	%	0.01	Proportion
Total (T ₃)	ng/dL	0.0154	nmol/L
Troponin I (cardiac)	ng/mL	1.0	μg/L
Troponin T (cardiac)	ng/mL	1.0	μg/L
Tryptophan	mg/dL	48.97	μmol/L
Tyrosine	mg/dL	55.19	μmol/L
Urea nitrogen	mg/dL	0.357	mmol/L
Uric acid	mg/dL	59.48	μmol/L
Valine	mg/dL	85.5	μmol/L
Vasoactive intestinal polypeptide	pg/mL	1.0	ng/L
Vitamin A (retinol)	μg/dL	0.0349	μmol/L
Vitamin B ₆ (pyridoxine)	ng/mL	4.046	nmol/L
Vitamin B ₁₂ (cyanocobalamin)	pg/mL	0.738	pmol/L
Vitamin C (ascorbic acid)	mg/dL	56.78	μmol/L
Vitamin D			
1,25-Dihydroxyvitamin D	pg/mL	2.6	pmol/L
25-Hydroxyvitamin D	ng/mL	2.496	nmol/L
Vitamin E	mg/dL	23.22	μmol/L
Vitamin K	ng/mL	2.22	nmol/L
Warfarin	μg/mL	3.247	μmol/L
White blood cell count	x 10 ³ /μL	1.0	x 10 ⁹ /L
White blood cell differential count (number fraction)	%	0.01	Proportion
Zinc	μg/dL	0.153	μmol/L

