

Aspects of distance and domination in graphs

V. Smithdorf

December 1995

Abstract

The first half of this thesis deals with an aspect of domination; more specifically, we investigate the vertex integrity of n -distance-domination in a graph, i.e., the extent to which n -distance-domination properties of a graph are preserved by the deletion of vertices, as well as the following: Let G be a connected graph of order p and let $\emptyset \neq S \subseteq V(G)$. An S - n -distance-dominating set in G is a set $D \subseteq V(G)$ such that each vertex in S is n -distance-dominated by a vertex in D . The size of a smallest S - n -dominating set in G is denoted by $\gamma_n(S, G)$. If S satisfies $\gamma_n(S, G) = \gamma_n(G)$, then S is called an n -distance-domination-forcing set of G , and the cardinality of a smallest n -distance-domination-forcing set of G is denoted by $\theta_n(G)$. We investigate the value of $\theta_n(G)$ for various graphs G , and we characterize graphs G for which $\theta_n(G)$ achieves its lowest value, namely, $\gamma_n(G)$, and, for $n = 1$, its highest value, namely, $p(G)$. A corresponding parameter, $\eta(G)$, defined by replacing the concept of n -distance-domination of vertices (above) by the concept of the covering of edges is also investigated.

For $k \in \{0, 1, \dots, \text{rad}(G)\}$, the set S is said to be a k -radius-forcing set if, for each $v \in V(G)$, there exists $v' \in S$ with $d_G(v, v') \geq k$. The cardinality of a smallest k -radius-forcing set of G is called the k -radius-forcing number of G and is denoted by $\rho_k(G)$. We investigate the value of $\rho_{\text{rad}(G)}$ for various classes of graphs G , and we characterize graphs G for which $\rho_{\text{rad}(G)}$ and $\rho_k(G)$ achieve specified values. We show that the problem of determining $\rho_k(G)$ is NP-complete, study the sequences $(\rho_0(G), \rho_1(G), \rho_2(G), \dots, \rho_{\text{rad}(G)}(G))$, and we investigate the relationship between $\rho_{\text{rad}(G)}(G)$ and $\rho_{\text{rad}(G)}(G + e)$, and between $\rho_{\text{rad}(G)}(G + e)$ and the connectivity of G , for an edge e of the complement of G .

Finally, we characterize integral triples representing realizable values of the triples (γ, i, p) , (γ, γ_t, i) , (γ, γ_c, p) , (γ, γ_t, p) and $(\gamma, \gamma_t, \gamma_c)$ for a graph.

Preface

The research on which this thesis is based was carried out in the Department of Mathematics and Applied Mathematics, University of Natal, Durban, from April 1993 to November 1995, under the supervision of Professor Henda C. Swart and the co-supervision of Dr Peter A. Dankelmann.

Unless specifically indicated to the contrary in the text, this thesis represents the author's own work and has not been submitted in any form to another university.

Acknowledgements

My foremost thanks go to Prof. Henda C. Swart for being so unquestionably “for” me during the time of research for this thesis, and for always being someone I could count on to give me encouragement and the strength to continue on the occasions when my stamina, enthusiasm, and interest flagged. It was very reassuring to know that her caring and guiding hand was always there.

I am most grateful to Dr Peter Dankelmann for the beautiful research techniques and ideas that he shared with me.

I owe my parents a huge debt of thanks for their fantastic support during every minute of my studies; for all their love and encouragement and selfless caring; for all the things they did, known and unknown to me, to make my life easier and enable me to focus on my studies.

Many thanks go to my godmother Hazel Peters, to Mary Jane Prentice and to my friends, particularly Johnny and Janet, who were so often and so consistently interested in, and supportive of, my research and my goals, and to those friends and acquaintances who offered much appreciated support and encouragement during the sometimes trying last few weeks of completion: Karl Brincat, Carole Broderick, Beverly McCarney, Laura Godson, Joanne Puren, and Lovell Southey.

I would like to thank Prof. J. H. Swart for the use of facilities in his department, as well as Dale Haslop for her unfailing friendliness and willingness to help me, particularly with typing. Thank you also to Dave Erwin who gave up his time and energy so willingly to help me master the rudiments of LaTeX.

Finally, I would like to express my appreciation to Mr Frank Fisher, Dr Jannie Pretorius, Dr Kuku Voyi, Dr Roger Jones and John Strachan for their continued support and interest in my studies, as well as to AECI (Pty) Ltd for generous financial support over the last four years, and to the University of Natal for the award of Graduate Assistantships and Doctoral Scholarships.

To my parents

Contents

1	Introduction	1
1.1	Aspects of Distance and Domination in Graphs	1
1.2	Definitions and Notation	3
2	Domination-Forcing Sets in Graphs	6
2.1	Introduction	6
2.2	Domination-forcing sets of G	7
2.3	Graphs G for which $\theta(G) = \gamma(G)$	13
2.4	More graphs with prescribed parameters	18
2.5	θ and domination-critical graphs	21
2.6	Covering-Forcing Sets	22
2.6.1	Introductory definitions and examples	22
2.6.2	Bounds and relations involving $\alpha(G)$	24
2.7	Edge-Domination by Edges	26
3	Aspects of n-Distance Domination	27
3.1	Introduction	27
3.2	The integrity of n -distance-domination	28
3.3	n -Distance-Domination-Forcing Sets of Graphs	34
3.3.1	Some Initial Results	41
3.3.2	More Graphs with Prescribed Parameters	44
4	Radius-Forcing Sets in Graphs	48
4.1	Introduction	48
4.2	The radius-forcing number of a graph	52
4.3	NP-Completeness considerations	59
4.4	Randomly k -forcing graphs	61
4.5	The effect on $\rho(G)$ of adding an edge	64
4.6	k -Radius-forcing sets	66

5	Characterizing sets of domination parameters	73
5.1	Introduction	73
5.2	Characterizing the realizable triples (γ, i, p) , (γ, γ_t, i) , (γ, γ_c, p) and (γ, γ_t, p)	84
5.3	Characterizing the realizable triples $(\gamma, \gamma_t, \gamma_c)$	93
	Bibliography	101

Chapter 1

Introduction

1.1 Aspects of Distance and Domination in Graphs

The roots of domination theory may be traced back to the nineteenth century, when the notion of dominating set of queens on a chessboard was first considered [dJ]. Domination theory was formally initiated by Ore in 1962 [Ore62] and Berge in 1973 [Ber73], and soon thereafter, many related concepts were introduced, such as total domination [CDH80], independent domination [AL78] and connected domination [SW79]. (For survey papers on domination, see [CH75], [Coc78], [LW80], [HLP85] and [Hen]; see also the comprehensive collection of papers in [HL91]. For a comprehensive bibliography of papers on dominating sets in graphs, see the bibliography compiled by Hedetniemi and Laskar [HL90].)

Domination theory is applicable to diverse fields, such as communication theory, political science, social network theory, experimental sciences, coding theory and computer science. As a simple example, let the vertices of G represent entities that may or may not be in direct communication with each other, where two vertices of G are adjacent if a direct communication link exists between the corresponding entities. For instance, the vertices may represent intersections in a street grid of a city, where adjacent vertices represent intersections that are exactly on city block apart; or centres in a transmission network where adjacent vertices represent centres that are within receiving range of each other. Computers in a microprocessor network may be represented by vertices which are adjacent if transferral of information between the corresponding computers can be accomplished in a single unit of time. Members of a human, animal or bacteriological population may be represented by vertices that are adjacent if, for example, the corresponding members can communicate directly or are adjacent in a food network or differ from each other within

some prescribed limits. A minimum dominating set then represents a smallest set D of entities such that each entity not contained in D is able to communicate directly with a member of D . For instance, the vertices in D may represent intersections in a street grid where facilities (fire hydrants, telephones, police posts, etc.) may be placed such that every inhabitant of the city is within a city block of such a facility. The vertices in D may denote a smallest subset of centres from which radio signals can be transmitted to reach all centres in the relevant network, or smallest sets of computers from which stored data can be communicated within unit time to all computers in a network. A minimum dominating set may represent a smallest subgroup of a human population, a minimum dominating set may correspond to a smallest representative subset of the population. If some subset S of vertices is of particular importance, the smallest number of vertices dominating each vertex in S is of interest (see [Vol88] and [Vol90]). (For discussion on some applications of domination, see, for example, Berge [Ber73], Liu [Liu68], Cockayne and Hedetniemi [CH77] and Kalbfleisch, Stanton, and Horton [KSH71].) A survey of results which are relevant to this thesis is presented in the appropriate chapters.

The concepts of distance between two vertices in a graph and the eccentricity, diameter and radius of a graph as well as the many applications of these concepts are so well-known as to require no introduction (see, for example, [BH90]). Less well-known or new concepts will be introduced where relevant in the text.

In Chapters 2, 3 and 4, we are mainly concerned with domination-forcing, n -distance-domination-forcing and radius-forcing sets of a graph G : A subset S of $V(G)$ is said to be *domination-forcing* (or *n -distance-domination-forcing*) if S is not dominated (or n -distance-dominated) by any set of vertices in G of cardinality smaller than $\gamma(G)$ (or $\gamma_n(G)$, respectively). A set $S \subseteq V(G)$ is *radius-forcing* in G (or, more generally, *k -radius-forcing*) in G if no vertex in G is at a distance less than $\text{rad}(G)$ (or k , respectively) from all vertices in S . Minimum cardinalities of such sets are investigated.

Various domination-related parameters of a graph may not in general vary independently of each other. In the last chapter, we characterize integral triples representing realizable values of the triples (γ, i, p) , (γ, γ_t, i) , (γ, γ_c, p) , (γ, γ_t, p) and $(\gamma, \gamma_t, \gamma_c)$ for a graph, where γ , i , γ_t and γ_c denote the domination number and, respectively, the independent, total and connected domination numbers.

1.2 Definitions and Notation

The basic text for the graph theory terminology and symbols used in this thesis is Chartrand and Lesniak's "Graphs and Digraphs" (second edition) [CL86]. We clarify our basic definitions as follows. In what follows, let G denote a graph. We shall use $p(G)$, $q(G)$, $V(G)$ and $E(G)$ to denote the order, size, vertex set and edge set, respectively, of G .

- If $v \in V(G)$, we denote the degree of v in G by $\deg_G v$; the minimum degree of G is given by $\delta(G) = \min\{\deg_G v; v \in V(G)\}$, and the maximum degree by $\Delta(G) = \max\{\deg_G v; v \in V(G)\}$.
- The complement \bar{G} of G is the graph with $V(\bar{G}) = V(G)$ and $E(\bar{G}) = \{uv; u, v \in V(G), u \neq v, uv \notin E(G)\}$.
- We define the (open) *neighbourhood* $N_G(v)$ of a vertex v in G to be $N_G(v) = \{w \in V(G); vw \in E(G)\}$. The *closed neighbourhood* $N_G[v]$ of v in G is the set $N_G[v] = N_G(v) \cup \{v\}$.
- A set $D \subseteq V(G)$ is a *dominating set* if, for all $v \in V(G) - D$, $N_G(v) \cap D \neq \emptyset$, i.e., every vertex of G is in D or has a neighbour in D .
- A set $T \subseteq V(G)$ is a *total dominating set* of G if, for all $v \in V(G)$, $N_G(v) \cap T \neq \emptyset$, i.e., a total dominating set is a dominating set in which each vertex is dominated by a vertex other than itself.
- A set $S \subseteq V(G)$ of vertices is an *independent set* of G if no two vertices in S are adjacent. A set $F \subseteq E(G)$ of edges is independent if no two edges in F are adjacent in G .
- A set $S \subseteq V(G)$ is *irredundant* if, for each $v \in S$, $N_G[v] \not\subseteq \bigcup_{w \in S-v} N_G[w]$, i.e., each vertex in S has a private neighbour. If, furthermore, S is not properly contained in any irredundant set, it is said to be *maximal irredundant*.
- The *irredundance number*, $\text{ir}(G)$, of G is the minimum number of vertices in a maximal irredundant set of G .
- The *domination number*, $\gamma(G)$, of G is the minimum number of vertices in a dominating set of G . If S is a minimum dominating set of G , we shall call S a $\gamma(G)$ -set.

- A vertex v of G is said to be a *critical* vertex of G if $\gamma(G - v) < \gamma(G)$. If $\gamma(G - u) < \gamma(G)$ for every vertex u of G and $\ell = \gamma(G)$, then G is said to be an ℓ -*vertex-critical* graph, or, more generally, a *vertex-domination-critical* graph (see [BCD84]).
- The *total domination number*, $\gamma_t(G)$, of G is the minimum number of vertices in a total dominating set of G .
- The *independent domination number*, $i(G)$, of G is the minimum number of vertices in an independent dominating set (equivalently, in a maximal independent set) of G .
- The *independence number*, $\beta(G)$, is the maximum number of vertices in an independent set of G .
- The *vertex covering number*, $\alpha(G)$, of G is the minimum number of vertices in a set S such that every edge has at least one vertex in S .
- The *edge covering number*, $\alpha_1(G)$, of a graph G without isolated vertices is the minimum number of edges in a set F of edges of G for which $V(G) = V(\langle F \rangle_G)$.
- The *matching number*, $\beta_1(G)$, of G is the maximum number of edges in an independent set.
- For $n \in \mathbf{N}$, $n \geq 2$, the wheel $W(n)$ on n spokes is defined to be C_3 if $n = 2$ and, for $n \geq 3$, the graph obtained from a n -cycle $C_n : v_1, v_2, \dots, v_n$ by the addition of a new vertex v and the edges vv_i for each i , $1 \leq i \leq n$.
- For $n \in \mathbf{N}$ and $m_i \in \mathbf{N}$ for i , $1 \leq i \leq n$, we denote the complete n -partite graph by K_{m_1, m_2, \dots, m_n} . We refer to the particular case $K_{1, n}$ as a *star*; we shall define $K_{1, 0}$ to mean K_1 .
- We shall say that a graph H has been obtained from the graph G by the contraction of an edge uv if $V(H)$ is obtained from $V(G)$ by the identification of the vertices u and v of G to form a vertex, say w , and if $E(H) = \{xy \in E(G); \{x, y\} \cap \{u, v\} = \emptyset\} \cup \{wx; x \notin \{u, v\}, \{ux, vx\} \cap E(G) \neq \emptyset\}$.
- We let $k(F)$ denote the number of components of a graph F .
- For $k, \ell \in \mathbf{N}$, $S(k, \ell)$ will denote the double star obtained from the disjoint union of stars $K_{1, k}$ and $K_{1, \ell}$ with central vertices u and v , respectively, by the insertion of the edge uv . Furthermore, $S_{m, n}(k, \ell)$ will denote the graph

obtained from $S(k, \ell)$ by subdividing each edge of $K_{1,k} \cup K_{1,\ell}$ $m - 1$ times and the edge uv $n - 1$ times.

- We shall use the notation $G \circ K_1$ to denote the corona of G and K_1 , i.e., the graph obtained from G by appending an end-vertex to each vertex of G .
- For a family G_1, G_2, \dots, G_n of graphs, we shall use the notation $G_1 + G_2 + \dots + G_n$ to denote the graph H where $V(H) = \bigcup_{i=1}^n V(G_i)$ and where $E(H) = \bigcup_{i=1}^n E(G_i) \cup \bigcup_{i=1}^{n-1} \{uv; u \in V(G_i), v \in V(G_{i+1})\}$.
- For a set S and $k \in \mathbb{N}$ with $k \leq |S|$, the term k -subset (or, more briefly, k -set) shall be used to mean any subset of S of cardinality k .
- If $S, T \subseteq V(G)$, we denote by $[S, T]_G$ the set of edges $uv \in E(G)$ with $u \in S$ and $v \in T$.
- The girth $g(G)$ is the size (or order) of a smallest cycle in G , if G is not a tree. If G is a tree, we set $g(G) = \infty$.
- For any positive integer k , a subset S of $V(G)$ is said to be a k -packing of G if the distance between each pair of distinct vertices in S exceeds k ; i.e., if $d_G(u, v) > k$ for all $u, v \in S$ with $u \neq v$. Any largest k -packing of G is called a *maximum k -packing* of G and its cardinality is known as the k -packing number of G , denoted by $P_k(G)$ (see [MM75]). We shall deal with 2-packings of G which are also known simply as *packings* of G and note that 1-packings of G are independent sets of vertices of G . We also observe that, if P is a packing and D a dominating set of G , then each vertex in $P - D$ is adjacent to at least one vertex in $D - P$ and no vertex in $D - P$ is adjacent to two vertices in $P - D$, hence $|P| \leq |D|$ and so $P_2(G) \leq \gamma(G)$.
- A subset S of $V(G)$ that is both a dominating set and a packing of G is called an *efficient dominating set* of G and has the property that each vertex of G is dominated by exactly one vertex of S ; i.e., $\sum_{v \in D} (1 + \deg v) = p(G)$.
- Given disjoint graphs G and H and vertices $x \in V(G)$ and $y \in V(H)$, the (x, y) -coalescence of G and H , denoted by $(G, x) \diamond (H, y)$, is the graph obtained from G and H by identifying the vertices x and y . If the identified vertices of G and H , respectively, are understood, we write simply $G \diamond H$ instead of $(G, x) \diamond (H, y)$.

Other definitions will be given as needed throughout the chapters.

Chapter 2

Domination-Forcing Sets in Graphs

2.1 Introduction

In 1992, Peter J. Slater proposed, in a private communication, the investigation of some kind of measure of the structural properties of a graph which help to determine the domination number of the graph. Specifically, he proposed the study of those sets of vertices of a graph G which can be dominated in G by no fewer than $\gamma(G)$ vertices and, particularly, of the size of the smallest such sets. The study of these sets, called γ -forcing sets, was initiated in [Smi92], is considerably extended in this chapter and generalized in Chapter 3. Formal definitions are as follows.

Definition 2.1.1. Let S and T be subsets of $V(G)$ and H a subgraph of G . Then, S is said to *dominate* T (or H) in G or said to be a *T -dominating set in G* if each vertex in T (or H) is an element of S or is adjacent in G to an element of S ; this is expressed symbolically by $S \rightarrow T$ (or $S \rightarrow H$). If S does *not* dominate T (or H) in G , we write $S \not\rightarrow T$ (or $S \not\rightarrow H$). (Note that it is not required that $S \subseteq T$; hence, a T -dominating set in G is not necessarily a dominating set of $\langle T \rangle_G$.) A T -dominating set in G of minimum cardinality is called a *minimum T -dominating set in G* and its cardinality, denoted by $\gamma(T, G)$, is called the *T -domination number in G* .

Our purpose is the investigation of smallest subsets of vertices of a graph G which cannot be dominated by subsets of $V(G)$ containing fewer than $\gamma(G)$ vertices.

Definition 2.1.2. Let G be a graph. A set $S \subseteq V(G)$ for which $\gamma(S, G) = \gamma(G)$ is called a *domination-forcing set of G* or (briefly) a *γ -forcing set of G* . (Clearly,

such a set exists for every graph G as $\gamma(V(G), G) = \gamma(G)$.) A γ -forcing set of G of minimum cardinality is known as a $\theta(G)$ -set and its cardinality, denoted by $\theta(G)$, is called the γ -forcing number of G .

2.2 Domination-forcing sets of G

Examples 2.2.1. 1. If $G \cong K_p$ and $T \subseteq V(G)$, $T \neq \emptyset$, then $\gamma(T, G) = 1 = \gamma(G)$, any singleton subset of $V(G)$ being a T -dominating set in G . So, any singleton subset of $V(G)$ is a $\theta(G)$ -set and $\theta(G) = 1$.

2. If $G \cong K_{m,n}$, $2 \leq m \leq n$, with partite sets V_1 and V_2 , then, for $T \subseteq V(G)$ such that $|T \cap V_i| \geq 2$ for $i \in \{1, 2\}$, we have $\gamma(T, G) = 2 = \gamma(G)$, whereas $\gamma(T, G) = 1$ if $|T \cap V_i| \leq 1$ for some $i \in \{1, 2\}$. Hence, any 4-set of vertices containing two vertices from each of the partite sets of G is a smallest γ -forcing set of G and hence a $\theta(G)$ -set; so $\theta(G) = 4$.

3. If $G \cong \bar{K}_p$ and $T \subseteq V(G)$, $T \neq \emptyset$, then $\gamma(T, G) = |T|$. Hence, $V(G)$ is the only γ -forcing set of G and so $\theta(G) = p$.

4. For the 9-cycle $C_9 : v_1, v_2, \dots, v_9, v_1$ if $T_1 = \{v_2, v_5, v_8\}$ and $T_2 = \{v_1, v_2, v_3\}$, then $\gamma(T_1, C_9) = 3 = \gamma(C_9)$ and $\gamma(T_2, C_9) = 1$. Since $\gamma(T, C_9) < 3$ for any 2-set of $V(C_9)$, it follows that $\theta(C_9) = 3$.

Hence, we note that there exist graphs G having proper subsets T of $V(G)$ for which $\gamma(T, G) = \gamma(G)$.

5. Let G be any graph that contains an induced subgraph isomorphic to P_3 (for example, if G is connected and non-complete with $p(G) \geq 3$), and let x, y, z be an induced path in G . Then, $T = \{x, z\}$ is such that $\gamma(\langle T \rangle_G) = 2 \neq 1 = \gamma(T, G)$.

6. $G \cong P_3$ and $H \cong K_1 \cup K_2$ are the non-complete graphs of smallest order for which the order exceeds the γ -forcing number. Any $S \subseteq V(G)$ with $S \neq \emptyset$ is a γ -forcing set of G (so $\theta(G) = 1$) and the subsets of $V(H)$ containing at least one vertex from each component of H are γ -forcing sets of H (so $\theta(H) = 2$).

7. If $G \cong S(m, n)$ ($2 \leq m \leq n$) with central vertices u and v , adjacent to the end-vertices u_1, u_2, \dots, u_m and v_1, v_2, \dots, v_n , respectively, and $S = \{u_1, v_1\}$, then $\gamma(S, G) = 2 = \gamma(G)$ and S is (obviously) a $\theta(G)$ -set.

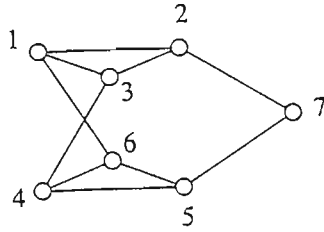

Figure 2.1: A graph with $\theta(G)$ -set S satisfying $\gamma(\langle S \rangle_G) > \gamma(S, G)$

It is immediately obvious that, for any graph G and $S \subseteq V(G)$, $\gamma(S, G) \leq \min\{\gamma(G), \gamma(\langle S \rangle_G)\}$. Except for Example 2.2.1. 5, the examples given above all have the property that, for any $\theta(G)$ -set S , $\gamma(\langle S \rangle_G) = \gamma(S, G) (= \gamma(G))$. That this is not true for every graph G is shown by Example 2.2.1. 5 and by the following example, in which is exhibited a graph G and a $\theta(G)$ -set S for which $\gamma(\langle S \rangle_G) > \gamma(S, G) (= \gamma(G))$.

Example 2.2.2. 1. The graph G shown in Figure 2.1 has domination number 2 and $\{2, 5\}$ is a minimum dominating set of G . Since the vertices in every pair of distinct, non-adjacent vertices in G have a common neighbour, $\gamma(T, G) = 1$ if $T \subseteq V(G)$ and $1 \leq |T| \leq 2$; hence, $\theta(G) \geq 3$. As the set $S = \{1, 4, 7\}$ satisfies $\gamma(S, G) = |\{2, 4\}| = 2 = \gamma(G)$ and $|S| = 3$, it follows that $\theta(G) = 3$ and that S is a $\theta(G)$ -set; furthermore, since S is independent, $\gamma(\langle S \rangle_G) = 3 > \gamma(S, G) = \gamma(G) = 2$.

We next investigate the relationship between $\theta(G)$ and $\gamma(G)$ for a graph G . Let G be a graph with an efficient dominating set D ; then, no two vertices of D are adjacent or have a common neighbour in G . Hence, each vertex in any D -dominating set in G dominates at most one vertex of D , so that, if D' is a minimum D -dominating set in G , we have $\gamma(D, G) = |D'| \geq |D|$. Since $D \rightarrow D$, we have $\gamma(D, G) \leq |D|$, whence it follows that $\gamma(D, G) = |D|$. Consequently, since $\gamma(D, G) \leq \gamma(G) \leq |D|$, D is a *minimum* dominating set of G .

Proposition 2.2.3. For any graph G ,

- (a) $\gamma(G) \leq \theta(G)$, and
- (b) $\gamma(G) = \theta(G)$ if G has an efficient dominating set.

Proof. Let G be any graph.

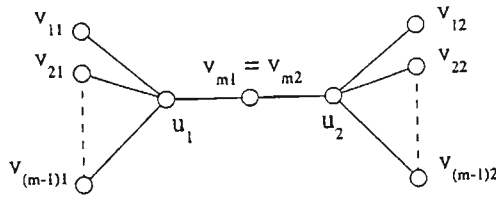

Figure 2.2: A graph with $\theta = \gamma$ having no efficient dominating set

- (a) If $S \subseteq V(G)$ and $|S| < \gamma(G)$, then $\gamma(S, G) \leq \gamma(\langle S \rangle_G) \leq |S| < \gamma(G)$ and S is not a $\theta(G)$ -set. Hence, for any $\theta(G)$ -set S , $\theta(G) = |S| \geq \gamma(G)$.
- (b) If G has an efficient dominating set D , then, as remarked above, $\gamma(D, G) = |D| = \gamma(G)$. Hence, D is a γ -forcing set of G and $\theta(G) \leq |D| = \gamma(G)$, which, with (a) yields $\theta(G) = \gamma(G)$.

□

That the (sufficient) condition given in Proposition 2.2.3(b) is not necessary to ensure that $\theta(G) = \gamma(G)$ may be seen by consideration of the graph G in Figure 2.2, obtained from $G_1 \cup G_2$ with $G_1, G_2 \cong K_{1,m}$, where G_i has centre u_i and end-vertices $v_{1i}, v_{2i}, \dots, v_{mi}$, by identifying v_{m1} and v_{m2} ($m \geq 3$). The only minimum dominating set of G is $D = \{u_1, u_2\}$ and $S = \{v_{11}, v_{12}\}$ satisfies $\gamma(S, G) = 2 = \gamma(G) = |S|$, whence S is a $\theta(G)$ -set and $\theta(G) = 2 = \gamma(G)$. Certainly, D is not an efficient dominating set of G (since $d(u_1, u_2) = 2$), and so *no* dominating set of G is efficient.

We shall show next that, for any given positive integer $j \in \mathbb{N}$, there exists a graph G for which $\gamma(G) = 2, \theta(G) - \gamma(G) = j$ and $p(G) - \theta(G) \geq j + 1$.

Example 2.2.4. For $j, t \in \mathbb{N}$ with $t \geq j + 1$, let $m = \binom{t}{j}$ and define the graph $J_{t,j}$ as follows:

Let $J_1 \cong K_t, J_2 \cong K_m$ and $J_3 \cong K_1$, with $V(J_1) = \{u_1, u_2, \dots, u_t\}, V(J_2) = \{v_1, \dots, v_m\}$ and $V(J_3) = \{w\}$, and let A_1, A_2, \dots, A_m be the m distinct subsets of $V(J_1)$ that have cardinality j . Let $V(J_{t,j}) = V(J_1) \cup V(J_2) \cup V(J_3)$ and $E(J_{t,j}) = E(J_1) \cup E(J_2) \cup \{wv_i; i = 1, 2, \dots, m\} \cup F$, where $F = \bigcup_{i=1}^m \{v_i u; u \in A_i\}$. (See Figure 2.3.)

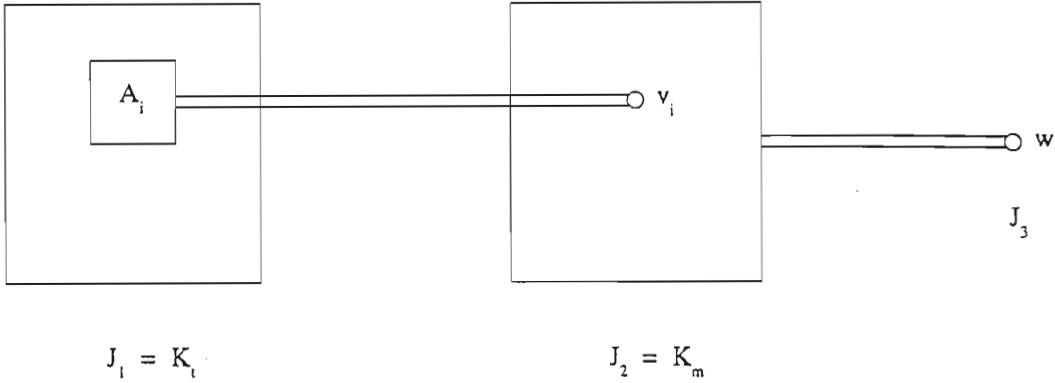

Figure 2.3: The graph $J_{t,j}$

Proposition 2.2.5. For $t, j \in \mathbb{N}$, $t \geq j + 1$ and $G \cong J_{t,j}$,

- (a) $\gamma(G) = 2$, and
- (b) $\theta(G) = j + 2$ and
- (c) $p(G) = t + \binom{t}{j} + 1 \geq 2t + 1 \geq 2\theta(G) - 1$.

Proof. Let t, j and G satisfy the hypothesis of the proposition; assume that the vertices of G are labelled as those of $J_{t,j}$ in Example 2.2.4.

- (a) Since $\Delta(G) < p(G) - 1$, it follows that $\gamma(G) \geq 2$; hence, as $\{u_1, w\} \rightarrow G$, $\gamma(G) = 2$.
- (b) Let $B \subseteq V(G)$ such that $|B \cap V(J_1)| \leq j$. Then, there exists $k \in \{1, 2, \dots, m\}$ such that $B \cap V(J_1) \subseteq A_k$; consequently, $\{v_k\} \rightarrow B$ and $\gamma(B, G) = 1$. Hence, it follows that, if S is a $\theta(G)$ -set (so $\gamma(S, G) = 2$), then $|S \cap V(J_1)| \geq j + 1$. Furthermore, $S \not\subseteq V(J_1)$ since, otherwise, $\{u_1\} \rightarrow S$ and $\gamma(S, G) = 1$; so $S - V(J_1) \neq \emptyset$ and $\theta(G) = |S| \geq (j + 1) + |S - V(J_1)| \geq j + 2$. To show that $\theta(G) \leq j + 2$, let $T = \{u_1, u_2, \dots, u_{j+1}, w\}$. Then, $\gamma(T, G) \geq 2$ since, otherwise, if there exists $y \in V(G)$ with $\{y\} \rightarrow T$, then $y \notin V(J_2) \cup V(J_3)$ (as no vertex in $V(J_2) \cup V(J_3)$ is adjacent to $j + 1$ vertices in $V(J_1)$) and so $y \in V(J_1)$, whence $\{y\} \not\rightarrow \{w\}$, contradicting $\{y\} \rightarrow T$. So $\gamma(G) = 2 \leq \gamma(T, G) \leq \gamma(G)$; i.e., $\gamma(T, G) = \gamma(G)$ and T is a γ -forcing set of G , whence $\theta(G) \leq |T| = j + 2$. Hence, $\theta(G) = j + 2$.

(c)

$$\begin{aligned}
p(G) &= t + \binom{t}{j} + 1 \\
&= t + t \frac{(t-1)(t-2)\dots(t-j+1)}{j(j-1)\dots 2 \cdot 1} + 1 \\
&\geq t + t + 1 = 2t + 1 \geq 2j + 3 = 2\theta(G) - 1.
\end{aligned}$$

□

We remark that, for $t = 2, j = 1$, we obtain a graph $J_{t,j}(= J_{2,1})$ of smallest possible order (namely, $p(J_{2,1}) = 5$), and we have $\theta(J_{2,1}) = 3$ and $\gamma(J_{2,1}) = 2$. In this case,

$$\frac{\theta(J_{2,1})}{p(J_{2,1})} = \frac{3}{5} > \frac{1}{2}.$$

In general, if $t = j + 1$, then

$$\frac{\theta(J_{j+1,j})}{p(J_{j+1,j})} = \frac{j+2}{2j+3} = \frac{1}{2} + \frac{1}{4j+6} \in \left(\frac{1}{2}, \frac{3}{5}\right]$$

and

$$\lim_{j \rightarrow \infty} \frac{\theta(J_{j+1,j})}{p(J_{j+1,j})} = \frac{1}{2}.$$

If $t = j + 2$, then $p(J_{t,j}) = j + \binom{j+2}{j} + 1$ and

$$\lim_{j \rightarrow \infty} \frac{\theta(J_{j+2,j})}{p(J_{j+2,j})} = 0;$$

furthermore, for any fixed $j \in \mathbf{N}$, we see from Proposition 2.2.5 (b) and (c) that

$$\lim_{t \rightarrow \infty} \frac{\theta(J_{t,j})}{p(J_{t,j})} = 0.$$

In the above example, $\gamma(J_{t,j}) = 2$. We shall show that, for prescribed $n \geq 2$, M and N , there exists a graph G for which $\gamma(G) = n, \theta(G) - \gamma(G) \geq M$ and $p(G) - \theta(G) \geq N$.

Example 2.2.6. For $t, j \in \mathbf{N}$ with $n \geq 2, t \geq (n-1)(j+1), m = \binom{t}{j}$, let $G_1, G_2, \dots, G_{n-1} \cong J_{t,j}$ (see Example 2.2.4) and, in G_i , let $V_{1i}, V_{2i}, u_{1i}, u_{2i}, \dots, u_{ti}, v_{1i}, v_{2i}, \dots, v_{mi}$ and w_i correspond to $V(J_1), V(J_2), u_1, u_2, \dots, u_t, v_1, v_2, \dots, v_m$ and w , respectively, in $J_{t,j}$, for $i = 1, 2, \dots, n-1$. Let $J_{t,j,n}$ be the graph obtained from G_1, G_2, \dots, G_{n-1} by identifying the vertices $v_{i1}, v_{i2}, \dots, v_{i(n-1)}$ to form a new vertex v_i^n corresponding to the vertex $v_i \in V(J_2)$ in $J_{t,j}$, for $i = 1, 2, \dots, m$. Denote the resulting set $\{v_1^n, v_2^n, \dots, v_m^n\}$ by V_2^n , and the subset of V_{1i} corresponding to A_k by A_{ki} ($i \in \{1, \dots, n-1\}, k \in \{1, \dots, m\}$). (Note that $J_{t,j,2} = J_{t,j}$.)

Proposition 2.2.7. For $t, j, n \in \mathbb{N}$ with $t \geq (n-1)(j+1)$, $n \geq 2$, and $G \cong J_{t,j,n}$,

(a) $\gamma(G) = n$,

(b) $\theta(G) = (n-1)(j+1) + 1 = \gamma(G) + (n-1)j$, and

(c) $p(G) = (n-1)(t+1) + \binom{t}{j} = \theta(G) + (n-1)(t-j) + \binom{t}{j} - 1$.

Proof. Let t, j, n and G satisfy the hypothesis of the proposition; assume that the vertices of G are labelled as in Example 2.2.6.

(a) That $\gamma(G) \leq n$ follows from the observation that $\{v_1^n, u_{11}, u_{12}, \dots, u_{1(n-1)}\} \rightarrow G$. If there exists a dominating set D of G with $|D| \leq n-1$, then $D \not\subseteq \bigcup_{i=1}^{n-1} V_{1i}$ (otherwise $D \not\rightarrow \{w_1, w_2, \dots, w_{n-1}\}$; hence, $D \cap V_{1i} = \emptyset$ for at least one value of $i \in \{1, 2, \dots, n-1\}$. So, V_{1i} is dominated by (at most $n-1$) vertices in $D \cap V_2^n$; however,

$$|N_G(D \cap V_2^n) \cap V_{1i}| \leq |D \cap V_2^n| \cdot j \leq (n-1)j < t = |V_{1i}|,$$

so that $D \cap V_2^n \rightarrow V_{1i}$ is impossible. So, any dominating set of G has cardinality at least n . So, $\gamma(G) = n$.

(b) Let S be a $\theta(G)$ -set. Suppose $|S \cap \bigcup_{i=1}^{n-1} V_{1i}| < (n-1)(j+1)$. Then, for at least one $i_0 \in \{1, 2, \dots, n-1\}$, we have $|S \cap V_{1i_0}| \leq j$. Let $k \in \{1, 2, \dots, m\}$ with $S \cap V_{1i_0} \subseteq A_{ki_0}$ and let $i_1, i_2, \dots, i_\ell \in \{1, 2, \dots, n-1\}$ be the indices i for which $S \cap V_{1i} \neq \emptyset$ and $i \neq i_0$. Then, clearly, $\{u_{1i_1}, u_{1i_2}, \dots, u_{1i_\ell}, v_k^n\} \rightarrow S$ (even if $S \cup (V_2^n \cup \{w_1, w_2, \dots, w_{n-1}\}) \neq \emptyset$), whence $\gamma(S, G) \leq |\{u_{1i_1}, \dots, u_{1i_\ell}, v_k^n\}| \leq n-1$, a contradiction. So $|S \cap \bigcup_{i=1}^{n-1} V_{1i}| \geq (n-1)(j+1)$. Furthermore, $S \not\subseteq \bigcup_{i=1}^{n-1} V_{1i}$, since otherwise $\{u_{11}, u_{12}, \dots, u_{1(n-1)}\}$ is an S -dominating set in G (contrary to $\gamma(S, G) = n$). So

$$|S| > |S \cap \bigcup_{i=1}^{n-1} V_{1i}| \geq (n-1)(j+1);$$

i.e., $\theta(G) \geq (n-1)(j+1) + 1$.

Let the set $V(J_1)$ in $J_{t,j}$ be partitioned into n subsets U'_1, U'_2, \dots, U'_n , where $|U'_i| = j+1$ for $i \in \{1, 2, \dots, n-1\}$ and $|U'_n| = t - (n-1)(j+1)$. Let U_i be the subset of V_{1i} corresponding to U'_i for $i = 1, 2, \dots, n-1$, and let $U = \bigcup_{i=1}^{n-1} U_i$, $S = U \cup \{w_1\}$; so $|S| = (n-1)(j+1) + 1$. We shall show that

$\gamma(S, G) = n$. Let D be a minimum S -dominating set in G and suppose that $|D| \leq n - 1$. We may assume that $D \cap \{w_1, \dots, w_{n-1}\} = \emptyset$, since otherwise $D \cap \{w_1, \dots, w_{n-1}\}$ may be replaced by $\{v_1^n\}$ in D , yielding an S -dominating set in G which is not larger than D . Say $|D \cap \left(\bigcup_{i=1}^{n-1} V_{1i}\right)| = k$ and $|D \cap V_2^n| = \ell$; then $k + \ell = |D| \leq n - 1$ and $\ell \geq 1$ (as D dominates w_1).

Each vertex of D in $\bigcup_{i=1}^{n-1} V_{1i}$ dominates $j + 1$ vertices of S (viz., those in some U_i) and each vertex of $D \cap V_2^n$ dominates w_1 and at most j vertices in $S - \{w_1\}$. Hence the number of vertices in S dominated by D is at most

$$k(j + 1) + \ell j + 1 \leq k(j + 1) + (n - 1 - k)j + 1;$$

however, D dominates S , so $|S| \leq k(j + 1) + (n - 1 - k)j + 1$, i.e.,

$$(n - 1)(j + 1) \leq k(j + 1) + (n - 1 - k)j = k + j(n - 1).$$

It follows that $k \geq n - 1$ which (with $\ell \geq 1$) yields $|D| \geq n$, a contradiction. So $\gamma(S, G) = n$ and the desired result (b) follows.

The result in (c) is obvious. □

2.3 Graphs G for which $\theta(G) = \gamma(G)$

We present next a series of elementary results culminating in the characterization of graphs G having $\theta(G) = \gamma(G)$. Recall that we always have $P_2(G) \leq \gamma(G) \leq \theta(G)$.

Proposition 2.3.1. *If graphs F, G and H satisfy $F \subset G \subset H$, then $\gamma(F, H) \leq \gamma(F, G)$.*

Proof. The result follows immediately from the observation that every F -dominating set in G is also an F -dominating set in H . □

In [MM75], Meir and Moon proved that $P_2(T) = \gamma(T)$ for every tree T . This result was extended by Erwin [Erw95], who proved that $P_2(G) = \gamma(G)$ for connected graphs G in which all blocks are complete, i.e., connected block graphs.

Proposition 2.3.2. *For every connected block graph G , $\theta(G) = \gamma(G)$; hence, for every tree T , $\theta(T) = \gamma(T)$.*

Proof. Let G be any graph. If S is a maximum 2-packing of G , then, by the result of Erwin given above, $|S| = \gamma(G)$. Clearly, $\gamma(S, G) = |S| = \gamma(G)$, so that S is a γ -forcing set of G . Thus, $\theta(G) \leq |S| = \gamma(G)$. However, $\theta(H) \geq \gamma(H)$ for every graph H . Hence, $\theta(G) = \gamma(G)$. \square

Proposition 2.3.3. *If G is a graph for which $\gamma(G) = \theta(G)$, then any $\theta(G)$ -set is a 2-packing (and, hence, $P_2(G) = \gamma(G) = \theta(G)$).*

Proof. Let G be a graph for which $\gamma(G) = \theta(G)$, and suppose there is a $\theta(G)$ -set S and vertices $u, v \in S$ with $d_G(u, v) \leq 2$. If $uv \in E(G)$, then $S - \{u\} \rightarrow S$. If $d_G(u, v) = 2$ and w is a common neighbour of u and v , then $(S - \{u, v\}) \cup \{w\} \rightarrow S$. In either case, $\gamma(S, G) \leq |S| - 1 < |S| = \theta(G) = \gamma(G) = \gamma(S, G)$ which is impossible. Hence every $\theta(G)$ -set is a 2-packing in G . \square

Proposition 2.3.4. *If G is a graph for which $P_2(G) = \gamma(G)$, then $\theta(G) = \gamma(G)$.*

Proof. Let G be a graph for which $P_2(G) = \gamma(G)$, and let S be a 2-packing of G with $|S| = \gamma(G)$. The proof now proceeds as the last part of the proof of Proposition 2.3.3. \square

Theorem 2.3.5. *Let G be a graph. Then, $\theta(G) = \gamma(G)$ if and only if $P_2(G) = \gamma(G)$.*

Proof. The theorem is a direct consequence of Propositions 2.3.3 and 2.3.4. \square

We remark, as an aside, that there exist graphs G which satisfy $P_2(G) = \gamma(G)$, but which have the property that no maximum packing of G has a single vertex in common with a minimum dominating set of G . For example, let $G_0 \cong S(3, 3)$, let d_1, d_2 denote the central vertices of G_0 , and let p_1, p_2 denote any two vertices of G_0 of degree one at distance 3. Then, the only minimum dominating set of G_0 is $\{d_1, d_2\}$, and, furthermore, if d_1 or d_2 belongs to a 2-packing P of G_0 , then $|P| = 1$; however, in fact, $P_2(G_0) = 2$ (for example, $P = \{p_1, p_2\}$ is a (maximum) packing of G_0). On the other hand, if graph G has an efficient dominating set $S \subseteq V(G)$, then S is simultaneously a $P_2(G)$ -set, a $\gamma(G)$ -set and a $\theta(G)$ -set.

We have shown that, if any two of the quantities $\gamma(G)$, $\theta(G)$, $P_2(G)$ are equal, then the third quantity equals the first two. We show next that deciding equality of these parameters is an NP-complete problem.

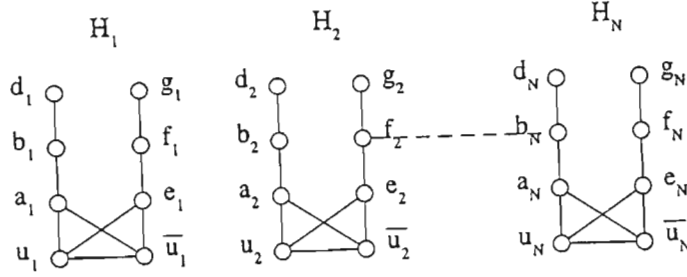

Figure 2.4: The literal subgraphs of G

From Garey and Johnson [GJ84], we know that the restricted 3-satisfiability problem is NP-complete.

Problem 3SAT

INSTANCE: Set $\mathcal{U} = \{u_1, u_2, \dots, u_N\}$ of variables, collection \mathcal{C} of clauses over \mathcal{U} such that each clause $c \in \mathcal{C}$ has $|c| = 3$ and, for each i , $1 \leq i \leq N$, there are at most 5 clauses in \mathcal{C} that contain either u_i or \bar{u}_i

QUESTION: Is there a truth assignment for \mathcal{U} such that each clause $c \in \mathcal{C}$ has at least one true literal?

Problem P2GT

INSTANCE: Graph $G = (V, E)$.

QUESTION: Is $P_2(G) = \gamma(G) = \theta(G)$? (Equivalently, is $P_2(G) = \gamma(G)$?)

Theorem 2.3.6. *Problem P2GT is NP-complete.*

Proof. Clearly, there exists a non-deterministic-polynomial time algorithm for finding a 2-packing set $P \subseteq V(G)$ and a $\gamma(G)$ -set $D \subseteq V(G)$ with $|P| = |D|$. We show next how a polynomial time algorithm for the P2GT problem could be used to solve 4SAT in polynomial time.

Let $\mathcal{C} = (u_{11} \vee u_{12} \vee u_{13}) \wedge (u_{21} \vee u_{22} \vee u_{23}) \wedge \dots \wedge (u_{M1} \vee u_{M2} \vee u_{M3})$ where $u_{ij} \in \{u_h, \bar{u}_h; 1 \leq h \leq N\}$, $1 \leq i \leq M, 1 \leq j \leq 3$ and where u_h or \bar{u}_h appears at most five times in \mathcal{C} for $1 \leq h \leq N$; so $M \leq \frac{5N}{3}$. Construct a graph $G = G(\mathcal{C})$ from \mathcal{C} as follows. As in Figure 2.4, let subgraph H_i , containing 8 vertices, correspond to literal u_i ($1 \leq i \leq N$). Next, for each clause $c_j = (u_{j1} \vee u_{j2} \vee u_{j3})$, $1 \leq j \leq M$, add to $H_1 \cup H_2 \cup \dots \cup H_N$ 18 new vertices connected as illustrated in Figure 2.5 where subgraph K_j corresponds to clause c_j . Note that Z_j, T_j and X_j are joined to u_{j1}, u_{j2} ,

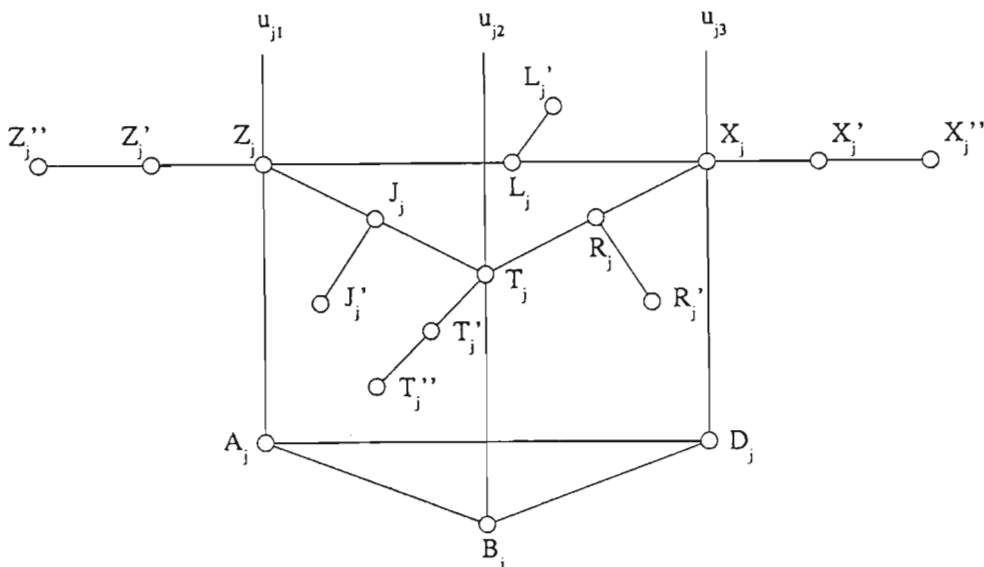

Figure 2.5: 18 additional vertices in subgraph K_j for clause $c_j = \{u_{j1} \vee u_{j2} \vee u_{j3}\}$

and u_{j3} , respectively. Graph G has $8N + 18M \leq 8N + 18 \left(\frac{5N}{3}\right) = 38N$ vertices and can be constructed from \mathcal{C} in polynomial time. The proof will be completed once we have shown that \mathcal{C} has a satisfying truth assignment $t : \mathcal{U} \rightarrow \{T, F\}$ if and only if $P_2(G) = \gamma(G)$. First, note the following lemma whose proof will follow the theorem's proof.

Lemma 2.3.7. $\gamma(G) = 3N + 7M$.

Now, first assume that \mathcal{C} has a satisfying truth assignment t . Define $P \subseteq V(G)$ as follows. Let P contain d_i and g_i for $1 \leq i \leq N$, and, from each K_j with $1 \leq j \leq M$, put Z''_j, T''_j, J'_j, L'_j and R'_j in P . For $1 \leq i \leq N$, if $t(u_i) = T$ (that is, u_i is true), put \bar{u}_i in P ; otherwise, we have $t(\bar{u}_i) = T$ and put u_i in P . Finally, for $1 \leq j \leq M$: if $t(u_{j1}) = T$ (so $u_{j1} \notin P$), put A_j in P ; otherwise, if $u_{j2} \notin P$, then we put B_j in P ; otherwise (i.e., if $u_{j1} \notin P$ and $u_{j2} \notin P$), then we must have $t(u_{j3}) = T$ and $u_{j3} \notin P$ and we put D_j in P . Then, P is a packing and $P_2(G) = |P| = 3N + 7M = \gamma(G)$.

Conversely, assume $P_2(G) = \gamma(G) = 3N + 7M$, and let $P \subseteq V(G)$ be a packing of order $3N + 7M$. Note, for example, that P must contain exactly one of a_i, b_i , and d_i , and we could replace a_i or b_i in P by d_i . In general, we can assume that P contains d_i and g_i for $1 \leq i \leq N$, and $Z''_j, T''_j, X''_j, J'_j, L'_j$ and R'_j for $1 \leq j \leq M$. Now, for P to have order $3N + 7M$, it must contain exactly one of u_i and \bar{u}_i for $1 \leq i \leq N$ and exactly one of A_j, B_j and D_j for $1 \leq j \leq M$. Define truth assignment $t : \mathcal{U} \rightarrow \{T, F\}$

by letting $t(u_i) = T$ if and only if $u_i \notin P$ (that is, if and only if $\bar{u}_i \in P$). Then, for clause c_j , $1 \leq j \leq M$, without loss of generality (WLOG) assume $B_j \in P$; then $u_{j2} \notin P$, so $t(u_{j2}) = T$. That is, t is a satisfying truth assignment for \mathcal{C} . \square

Proof of Lemma 2.3.7. Defining $D \subseteq V(G)$ by having $\mathcal{C} \cap V(H_i) = \{b_i, f_i, u_i\}$, $1 \leq i \leq N$, and $\mathcal{D} \cap V(K_j) = \{Z'_j, T'_j, X'_j, J_j, L_j, R_j, A_j\}$, $1 \leq j \leq M$, gives us a dominating set of order $3N + 7M$; so, $\gamma(G) \leq 3N + 7M$.

Let D be a minimum dominating set for G . Then, D contains one of d_1 and b_1 , and we could replace d_1 by b_1 and, in general, we can assume D contains $b_i, f_i, Z'_j, T'_j, X'_j, J_j, L_j$ and R_j for each i , $1 \leq i \leq N$, and j , $1 \leq j \leq M$. Clearly, for $1 \leq j \leq M$, $|\mathcal{D} \cap \{A_j, B_j, D_j\}| \leq 1$, and if $|\mathcal{D} \cap \{A_j, B_j, D_j\}| = 1$, then we could replace Z_j by u_{j1} , T_j by u_{j2} , and/or X_j by u_{j3} in D . That is, we can assume that $|\mathcal{D} \cap \{A_j, B_j, D_j\}| = 1$ implies $|\mathcal{D} \cap \{Z_j, T_j, X_j\}| = 0$. Also, $|\mathcal{D} \cap \{A_j, B_j, D_j\}| = 0$ implies $\{Z_j, T_j, X_j\} \subseteq D$. Therefore, if $|\mathcal{D} \cap \{A_j, B_j, D_j\}| = 1$ for each j , $1 \leq j \leq M$, then, since u_i is dominated by D for each i , $1 \leq i \leq N$, we have $\mathcal{D} \cap \{a_i, e_i, u_i, \bar{u}_i\} \neq \emptyset$ for each i , $1 \leq i \leq N$. This implies $|D| = 3N + 7M$.

Thus, the proof of the lemma will be complete if we show that, when $\{Z_j, T_j, X_j\} \subseteq D$ for some j , $1 \leq j \leq M$, we can modify D to contain one of A_j, B_j, D_j . To that end, suppose $j \in \{1, 2, \dots, M\}$ is such that $\{Z_j, T_j, X_j\} \subseteq D$. If, for example, u_{j1} is dominated not only by Z_j but by some other vertex in D , then $(\mathcal{D} - \{Z_j, T_j, X_j\}) \cup \{A_j, u_{j2}, u_{j3}\}$ is also a dominating set. Thus, we may assume that $Z_j \in D$ implies Z_j is the sole dominator of u_{j1} (as is T_j for u_{j2} and X_j for u_{j3}). Without loss of generality, assume $\{Z_1, T_1, X_1\} \subseteq D$ and $u_{12} = u_1$. T_1 uniquely dominates u_1 , which implies that \bar{u}_1 is dominated only by vertices in the set $\{Z_j, T_j, X_j; 1 \leq j \leq M\}$; in fact, we may assume that \bar{u}_1 is dominated by a single vertex in $\{Z_j, T_j, X_j; 1 \leq j \leq M\}$ since if, for example, Z_{k_1} and T_{k_2} both dominate \bar{u}_1 for some $k_1, k_2 \in \{1, 2, \dots, M\}$, then we could replace, say, T_{k_2} by B_{k_2} . Without loss of generality, suppose that \bar{u}_1 is uniquely dominated by Z_2 . T_2 is the sole dominator of u_{22} —without loss of generality, assume $u_{22} = u_2$ —and we may assume that Z_3 is the sole dominator of \bar{u}_2 , and so on. In brief, we can assume that G has edges $T_\ell u_\ell, \bar{u}_\ell Z_{\ell+1}$ for $1 \leq \ell \leq k$ for some k , $1 \leq k \leq N - 1$, where $\{Z_j, T_j, X_j\} \subseteq D$, $1 \leq j \leq k + 1$. For $1 \leq j \leq k + 1$, in D replace T_j by u_j , replace Z_j by A_j , and replace X_j by u_{j3} . The resulting set is also a dominating set of G of order $3N + 7M$. \square

We close this section by remarking that, in Section 4.3, we prove that, for the set of all graphs H having $\text{rad}(H) = \gamma(H) = 2$, the decision problem associated with

determining $\theta(H)$ is NP-complete (see Theorem 4.3.3).

2.4 More graphs with prescribed parameters

With the following two results, we investigate further the possibility of prescribing the values of $\theta(G)$, $\gamma(G)$, $\theta(G) - \gamma(G)$ for a graph G .

Lemma 2.4.1. *For any graph G of order p and domination number γ , there exists a graph H containing G as an induced subgraph, with $p(H) = p + \gamma$ and $\theta(H) = \gamma(H) = \gamma$.*

Proof. Let G be any graph of order p and domination number γ , and let D be a minimum dominating set of G . Let $V(G) = \{v_1, v_2, \dots, v_p\}$ and, without loss of generality, suppose that $D = \{v_1, v_2, \dots, v_\gamma\}$. We produce a new graph H from G by adding γ new vertices $u_1, u_2, \dots, u_\gamma$, and the edge $u_i v_i$ for each $i \in \{1, 2, \dots, \gamma\}$. No vertices in the set $S = \{u_1, u_2, \dots, u_\gamma\}$ have a common neighbour in H . Hence, if T is any S -dominating set in H , then each vertex of T dominates at most one vertex of S , and we have $|T| \geq |S|$, and thus $\gamma(S, H) \geq |S|$. However, S dominates itself, whence $\gamma(S, H) \leq |S|$. Thus, $\gamma(S, H) = |S| = \gamma$. That $\gamma(H) = \gamma$ follows from $\gamma(H) \leq \gamma$ (since D dominates H) and $\gamma(H) \geq \gamma(S, H) = \gamma$. Thus, it follows that $\gamma(S, H) = \gamma(H)$, i.e., S is a γ -forcing set. So, $\theta(H) \leq |S| = \gamma = \gamma(H)$. Since $\theta(F) \geq \gamma(F)$ for all graphs F , we have $\theta(H) = \gamma(H) = \gamma$, as required. \square

We recall that, for a connected graph H , $\gamma(H) \leq \frac{1}{2}p(H)$.

Theorem 2.4.2. *Let $\gamma, p \in \mathbf{N}$.*

- (a) *If $p \geq \gamma$, there exists a graph H with $p(H) = p$ and $\gamma(H) = \gamma = \theta(H)$.*
- (b) *If $p \geq 2\gamma$, there exists a connected graph H with $p(H) = p$ and $\gamma(H) = \gamma = \theta(H)$.*

Proof. Let $\gamma, p \in \mathbf{N}$ with $p \geq \gamma$. If $p = \gamma$, then $H \cong \bar{K}_p$, and H has the required properties. If $2\gamma > p > \gamma \geq 2$, let $H \cong \bar{K}_{\gamma-1} \cup K_{1, p-\gamma}$; then $\gamma(H) = \gamma$ and any γ -set of vertices containing a vertex from each component of H is a γ -forcing set of H , so that $\theta(H) = \gamma$, as required. If $p \geq 2\gamma$, then, for $t = \gamma$, the graph H in Figure 2.6 has $p(H) = p$ and $\gamma(H) = \gamma = \theta(H)$. \square

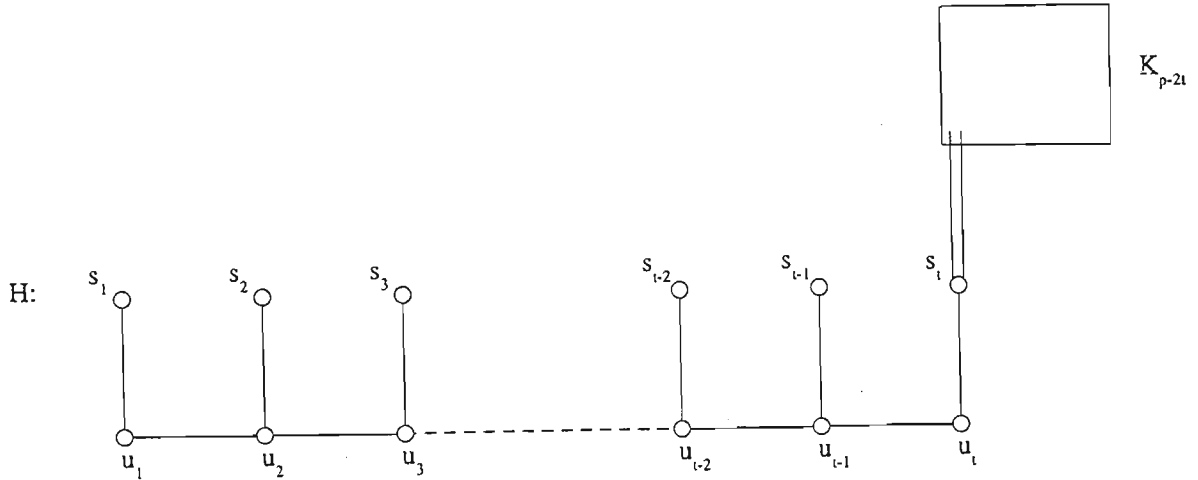

Figure 2.6: A connected graph with $p \geq 2\gamma$

Finally, we observe that, for any $k \in \mathbb{N}$, there exists a graph G with $\theta(G) - \gamma(G) = k$; for instance, the graph $G = kH$, where H is the graph in Figure 2.1, satisfies $\theta(G) - \gamma(G) = k[\theta(H) - \gamma(H)] = k(3 - 2) = k$.

We consider next the value of the parameter θ for cycles. (Note that the following theorem provides a non-empty graph G , namely C_{3k+1} , for which the bound $\theta(G) = p(G)$ is attained.)

Theorem 2.4.3. *Let $n \in \mathbb{N}$ with $n \geq 3$. Then*

$$\theta(C_n) = \begin{cases} \gamma(C_n) = \frac{n}{3} & \text{if } n \equiv 0 \pmod{3} \\ n & \text{if } n \equiv 1 \pmod{3} \\ \frac{1}{3}(2n - 1) & \text{if } n \equiv 2 \pmod{3} \end{cases}.$$

Proof. Let $n \in \mathbb{N}$ with $n \geq 3$, and let $C_n : u_0, u_1, \dots, u_n (= u_0)$. Suppose first that $n \equiv 0 \pmod{3}$. Clearly, $D = \{u_0, u_3, u_6, \dots, u_{n-3}\}$ is an efficient dominating set of C_n , and hence (by our comments preceding Proposition 2.2.3), $\gamma(D, C_n) = |D| = \frac{n}{3} = \gamma(C_n)$; so, $\theta(C_n) \leq |D| = \gamma(C_n)$. By Proposition 2.2.3, $\gamma(C_n) \leq \theta(C_n)$. Hence, $\theta(C_n) = \gamma(C_n)$ for $n \equiv 0 \pmod{3}$.

Suppose now that $n \equiv 1 \pmod{3}$. Let $\emptyset \neq R \subset V(C_n)$. Clearly, $\langle R \rangle \subset C_n - v$ for some $v \in V(C_n)$. Hence, $\gamma(R, C_n) \leq \gamma(R, C_n - v) \leq \gamma(C_n - v) = \frac{n-1}{3} < \lceil \frac{n}{3} \rceil = \gamma(C_n)$. Thus, $\theta(G) \geq |R| + 1$ for all $\emptyset \neq R \subset V(C_n)$, i.e., $\theta(C_n) \geq p(C_n)$. So, $\theta(C_n) = n$.

Finally, suppose that $n \equiv 2 \pmod{3}$, say, $n = 3k + 2$ for some $k \in \mathbb{N}$. Let $S = \{u_0, u_{3i-1}, u_{3i}; i = 1, \dots, k\}$; then $|S| = 2k + 1$ and $\gamma(S, C_n) \leq \gamma(C_n) = k + 1$. Furthermore, if $T \subseteq V(C_n)$ and $T \rightarrow S$, then each vertex in T dominates at most two vertices in S and so $|T| \geq \lceil \frac{1}{2}|S| \rceil = k + 1$. It follows that $\gamma(S, C_n) = k + 1 = \gamma(C_n)$; hence S is a γ -forcing set of C_n and $\theta(C_n) \leq |S| = 2k + 1$.

To show that $\theta(C_n) = 2k + 1$, we assume that a γ -forcing set R of C_n exists with $|R| \leq 2k$. Let $T = V(C_n) - R$; then $t = |T| \geq k + 2$.

We observe that T is an independent set in C_n : Otherwise, if T contains two adjacent vertices, u_i and u_{i+1} , then $C_n - \{u_i, u_{i+1}\}$ is a path P of order $3k$ containing all the vertices in R and $\gamma(R, C_n) \leq \gamma(R, P) \leq \gamma(P) = k < \gamma(C_n)$, a contradiction.

It follows that $\langle R \rangle$, the subgraph of C_n induced by R , is the union of t paths, P_1, P_2, \dots, P_t . For $i \in \{1, \dots, t\}$, let ℓ_i denote the order of P_i , and let j_i be the smallest index of a vertex u_{j_i} in $V(P_i)$ and label the paths so that $j_1 < j_2 < \dots < j_t$. Denote by m_j the number of components of $\langle R \rangle$ of order j ($j \in \{1, 2, \dots\}$) and note that, as $2k \geq |R| \geq m_1 + 2(t - m_1) = 2t - m_1 \geq 2k + 4 - m_1$, it follows that $m_1 \geq 4$.

That there cannot be a sequence of components of $\langle R \rangle$, namely $P_i, P_{i+1}, \dots, P_{i+\ell}$ ($\ell \geq 1$), with $\ell_i = \ell_{i+\ell} = 1$ and $\ell_j = 2$ for $j, i + 1 \leq j \leq i + \ell - 1$ (if $\ell \geq 2$) may be seen as follows: Assume that such a sequence of paths exists and let $N = N[V(P_i) \cup \dots \cup V(P_{i+\ell})]$. Let $Q' = \langle N \rangle$ and $Q'' = \langle V(C_n) - N \rangle$; then Q' and Q'' are paths of order $3\ell + 2$ and $3(k - \ell)$, respectively. The set $R \cap V(Q')$ is dominated by the set of ℓ vertices of T between v_{j_i} and $v_{j_{i+\ell}}$ in Q' , hence $\gamma(R \cap V(Q'), Q') \leq \ell$, while $\gamma(R \cap V(Q''), Q'') \leq \gamma(Q'') = k - \ell$. So $\gamma(R, C_n) \leq \gamma(R \cap V(Q'), Q') + \gamma(R \cap V(Q''), Q'') \leq \ell + (k - \ell) = k < \gamma(C_n)$, a contradiction.

We may therefore conclude that, if P_i and $P_{i+\ell}$ are trivial components of $\langle R \rangle$ ($\ell > 0$), there exists a component P_j of $\langle R \rangle$ of order $\ell_j \geq 3$ such that $i < j < i + \ell$. Consequently, $m_1 \leq m_3 + m_4 + \dots$ and we obtain

$$\begin{aligned} 2k \geq |R| &\geq m_1 + 2(t - m_1 - m_3 - m_4 \dots) + 3(m_3 + m_4 + \dots) \\ &= 2t - m_1 + (m_3 + m_4 + \dots) \geq 2t \geq 2k + 4, \end{aligned}$$

from which contradiction it follows that $\theta(C_n) \geq 2k + 1$.

We may therefore conclude that $\theta(C_n) = \frac{1}{3}(2n - 1)$ if $n \equiv 2 \pmod{3}$. \square

2.5 θ and domination-critical graphs

The next proposition reveals that the graphs G for which the upper bound on $\theta(G)$, namely, $p(G)$, is actually attained are precisely the vertex-domination-critical graphs, i.e., graphs G such that $\gamma(G - u) < \gamma(G)$ for all $u \in V(G)$. (Moreover, a graph H will be called k -vertex-critical if $\gamma(H) = k$ and $\gamma(G - v) < k$ for every vertex $v \in V(H)$.)

Theorem 2.5.1. *For a graph G , $\theta(G) = p(G)$ if and only if G is vertex-domination-critical.*

Proof. Let G be a graph. Suppose first that $\theta(G) = p(G)$. Let $v \in V(G)$, and let $S = V(G) - \{v\}$. Since $\theta(G) = p(G)$ and $|S| < p(G)$, it follows that $\gamma(S, G) < \gamma(G)$, i.e., there is some set $T \subseteq V(G)$ with $|T| < \gamma(G)$ such that $T \rightarrow \langle S \rangle = G - v$, but $T \not\rightarrow G$, hence $v \notin T$ and $\gamma(G - v) \leq |T| = \gamma(G) - 1$. Since v is an arbitrary vertex of G , the vertex-domination-criticality of G follows.

Conversely, suppose G is vertex-domination-critical. Let $\emptyset \neq S \subset V(G)$, and let $v \in V(G) - S$. By the vertex-domination-criticality of G , there is a subset $T \subseteq V(G) - \{v\}$ such that $|T| < \gamma(G)$ and $T \rightarrow G - v$. So, since $S \subseteq V(G) - \{v\}$, we have $T \rightarrow S$ and $\gamma(S, G) \leq |T| < \gamma(G)$. Hence, the only γ -forcing set of G is $V(G)$, and $\theta(G) = p(G)$ follows. \square

Corollary 2.5.2. *Let G and H be graphs and $G \diamond H$ any coalescence of G and H . Then $\theta(G \diamond H) = p(G \diamond H)$ if and only if $\theta(G) = p(G)$ and $\theta(H) = p(H)$.*

Proof. Let G and H be graphs. Suppose first that $\theta(G) = p(G)$ and $\theta(H) = p(H)$. By Theorem 2.5.1, both G and H are vertex-domination-critical. Hence, by Lemma 5 of [BCD84], $G \diamond H$ is vertex-domination-critical. The desired result now follows from Theorem 2.5.1.

Conversely, suppose $G \diamond H$ is a coalescence of G and H satisfying $\theta(G \diamond H) = p(G \diamond H)$. By Theorem 2.5.1, $G \diamond H$ is vertex-domination-critical, and so (again by Lemma 5 of [BCD84]) it follows that both G and H are vertex-domination-critical. Hence, it follows from Theorem 2.5.1 that $\theta(G) = p(G)$ and $\theta(H) = p(H)$. \square

Next we give a sufficient condition for a coalescence H to satisfy $P_2(H) = \gamma(H)$.

Proposition 2.5.3. *Let F be a graph with $P_2(F) = \gamma(F)$. Let G be a graph with $P_2(G) = \gamma(G)$ and the further property that G contains a critical vertex, v say, and a maximum packing P with $v \in P$. Then, for any vertex u belonging to a maximum packing of F ,*

$$P_2((F, u) \diamond (G, v)) = P_2(F) + P_2(G) - 1 = \gamma(F) + \gamma(G) - 1 = \gamma((F, u) \diamond (G, v)).$$

Proof. Let F and G be graphs satisfying the hypothesis of the proposition. Let v be a critical vertex of G that belongs to a maximum packing P_1 of G ; let P_2 be a maximum packing of F and let $u \in P_2$. Let D_1 be a minimum dominating set of F and D_2 a minimum dominating set of $G - v$; then, clearly, $D_1 \cup D_2 \rightarrow H = (F, u) \diamond (G, v)$, whence $\gamma(H) \leq |D_1| + |D_2| = \gamma(F) + \gamma(G) - 1$. Since $\gamma(I \diamond J) \geq \gamma(I) + \gamma(J) - 1$ for all graphs I and J and coalescence $I \diamond J$ of I and J (see [BCD84]), we have $\gamma(H) = \gamma(F) + \gamma(G) - 1$. Furthermore, $P_1 \cup P_2$ is obviously a 2-packing of H , whence $P_2(H) \geq |P_1 \cup P_2| = |P_1| + |P_2| - 1 = \gamma(F) + \gamma(G) - 1 = \gamma(H)$. By our comments on page 5, it then follows that $P_2(H) = P_2(F) + P_2(G) - 1$. \square

Corollary 2.5.4. *Let F be a graph with $\theta(F) = \gamma(F)$. Let G be a graph with $\theta(G) = \gamma(G)$ and the property that G contains a critical vertex v and a maximum packing containing v . Then, for any vertex u belonging to a maximum packing of F ,*

$$\theta((F, u) \diamond (G, v)) = \gamma((F, u) \diamond (G, v)).$$

Proof. The corollary follows immediately from Propositions 2.3.4 and 2.5.3. \square

Proposition 2.5.5. *Let $k \in \mathbf{N}$. Then, there exists a connected graph G with $\theta(G) = p(G)$ and $\theta(G) - \gamma(G) \geq k$.*

Proof. Let $k \in \mathbf{N}$. Let $H \cong K_{i+2}$, where $i = 2\lceil \frac{1}{2}k \rceil$ and let F be a 1-factor of H . Then (by Theorem 1 of [BCD84]), $G = H - F$ is 2-vertex-critical, so that, by Theorem 2.5.1, $\theta(G) = p(G) \geq k + 2$. Thus, $\theta(G) - \gamma(G) \geq (k + 2) - 2 = k$. \square

2.6 Covering-Forcing Sets

2.6.1 Introductory definitions and examples

Consider a graph G representing the street grid of a city. Suppose police officers are to be stationed at the intersections of streets and that each officer can see along

each street emanating from his/her intersection for a distance of one block (i.e., up to the next intersection along the street). If we are to select a smallest set of intersections from which officers can observe every section of every street, we obviously wish, equivalently, to identify a minimum (vertex) cover of G . Recall that we denote the covering number of G by $\alpha(G)$ and the independence number of G by $\beta(G)$, and that $\alpha(G) + \beta(G) = p(G)$ (Gallai [Gal59]). A minimum covering of G will also be denoted briefly as an $\alpha(G)$ -cover.

We generalise, in a sense, the definition of a covering of a graph as follows.

Definition 2.6.1. For a graph G and any set $F \subseteq E(G)$, a *covering of F in G* (or an *F -covering in G*) is a set $K \subseteq V(G)$ such that every edge in F has at least one end in K . The cardinality of a smallest such F -covering in G will be denoted by $\alpha(F, G)$ and called the *F -covering number in G* .

Note that, for a graph G , with $T \subseteq V(G)$ and $F \subseteq E(G)$, there is an essential difference between $\gamma(T, G)$ and $\alpha(F, G)$: the value of $\gamma(T, G)$ is *not* necessarily equal to $\gamma(\langle T \rangle_G)$, whereas $\alpha(F, G) = \alpha(\langle F \rangle_G)$.

Definition 2.6.2. For a graph G , a *covering-forcing set of G* (or, more briefly, an *α -forcing set of G*) is any subset F of $E(G)$ such that $\alpha(G, F) = \alpha(G)$. The cardinality of a smallest α -forcing set of G is called the *α -forcing number of G* , denoted by $\eta(G)$, and each such smallest α -forcing set is known as an $\eta(G)$ -set.

Examples 2.6.1. 1. For any $m \in \mathbf{N}$, $\alpha(K_{1,m}) = \eta(K_{1,m}) = 1$.

2. For any $m, n \in \mathbf{N}$, with $m \leq n$, $G = mK_2$ or $G = K_{m,n}$ has $\alpha(G) = m$ and $\eta(G) = m$, any maximum matching of G being a smallest α -forcing set of G .

3. Let $p \in \mathbf{N}$ and consider $G = K_p$. Then, $\beta(G) = 1$ and $\alpha(G) = p - 1$. Let $F \subset E(G)$ and let $e = uv \in E(G) - F$. Then, $V(G) - \{u, v\}$ covers $E(G) - \{e\} \supseteq F$, so that $\alpha(F, G) \leq p - 2 < \alpha(G)$. Hence, if $F' \subseteq E(G)$ satisfies $\alpha(F', G) = \alpha(G)$, then $F' = E(G)$. So, $\eta(G) = q(G)$.

4. Notice that, for any graph G and $F \subseteq E(G)$, $\alpha(\langle F \rangle_G) = \alpha(G - (E(G) - F))$ and that $\eta(G)$ is the smallest number of edges of G , in a set F say, for which the spanning graph H of G with edge set F has $\beta(H) = \beta(G)$. This is possibly a more interesting interpretation of $\eta(G)$ than the definition, and gives rise to the equivalent observation that, for a graph G , the quantity $q(G) - \eta(G)$ is the

largest number of edges that can be removed from G to produce a graph with independence number no larger than $\beta(G)$.

5. The graph G in Figure 2.1 is such that $\alpha(G) = 4$, $\eta(G) = 5$ and $q(G) = 10$.

Proof. Obviously, $\beta(G) = 3$ and $\alpha(G) = 4$. Furthermore, a maximum matching of G has cardinality three. So any set of four edges can be covered with three vertices and we have $\eta(G) \geq 5$. Let $S = \{12, 23, 31, 46, 57\}$; then $\langle S \rangle_G \cong K_3 \cup 2K_2$ and $\alpha(S, G) = \alpha(\langle S \rangle_G) = 4 = \alpha(G)$; so $\eta(G) = 5$. \square

2.6.2 Bounds and relations involving $\alpha(G)$

Proposition 2.6.2. *For any graph G , $\alpha(G) \leq \eta(G) \leq q(G)$.*

That the above bounds are sharp is seen from Examples 2.6.1. 1 and 2.6.1. 2. In fact, it is easy to see that a graph G satisfies $\eta(G) = q(G)$ if and only if either G is not empty and $\alpha(F, G) < \alpha(G)$ for every proper subset F of $E(G)$, or G is empty.

Proposition 2.6.3. *Given $N \in \mathbb{N}$, there exists a graph G with $q(G) - \eta(G) \geq N$.*

Proof. Let $N \in \mathbb{N}$. For $t, j \in \mathbb{N}$ with $t \geq j + 1$, consider the graph $J_{t,j}$ described in Example 2.2.4. Since $\beta(T_{t,j}) = 2$, we have $\alpha(J_{t,j}) = p(J_{t,j}) - \beta(J_{t,j}) = \binom{t}{j} + t + 1 - 2 = m + t - 1$. Let $E' = E(J_{t,j}) - [V(J_1), V(J_2)]$. Then, it is easily seen that $\alpha(E', J_{t,j}) = m + t - 1 = \alpha(J_{t,j})$, whence E' is an α -forcing set of $J_{t,j}$, and $\eta(J_{t,j}) \leq |E'| = q(J_{t,j}) - mj$. Hence, $q(J_{t,j}) - \eta(J_{t,j}) \geq mj$. An appropriate choice of t and j yields the desired result. \square

For the next result, we recall that $\beta_1(G)$ denotes the cardinality of a maximum matching of a graph G . For every graph G , we have $\beta_1(G) \leq \alpha(G) \leq \eta(G)$.

Proposition 2.6.4. *For any graph G , $\alpha(G) = \eta(G)$ if and only if $\beta_1(G) = \alpha(G)$.*

Proof. Let G be a graph of order p . Since $\alpha(\bar{K}_p) = \eta(\bar{K}_p) = \beta_1(\bar{K}_p) = 0$, we shall assume that G is non-empty. Let M be a matching of G with $|M| = \beta_1(G)$. Then (since $\alpha(G)$ vertices suffice to cover all edges in M and since no vertex of G covers two edges in M), $\alpha(G) \geq |M| = \beta_1(G)$.

Suppose $\alpha(G) = \eta(G)$. Then any $\eta(G)$ -set F contains $\alpha(G)$ edges and is hence a matching (since $\alpha(F, G) = \alpha(G) = |F|$). So $\beta_1(G) \geq \alpha(G)$, and the desired result

follows.

Conversely, suppose $\beta_1(G) = \alpha(G)$ and let F be a maximum matching of G . Then, $\alpha(F, G) = |F| = \beta_1(G) = \alpha(G)$ and F is an α -forcing set. So, $\eta(G) \leq |F| = \alpha(G)$. However, $\eta(G) \geq \alpha(G)$. So, $\eta(G) = \alpha(G)$. \square

Corollary 2.6.5. *For $n \in \mathbf{N}$,*

$$\begin{aligned}\eta(C_{2n}) &= \alpha(C_{2n}) = n, \quad n \geq 2 \\ \eta(C_{2n+1}) &= q(C_{2n+1}) = 2n + 1, \quad n \geq 1\end{aligned}$$

Proof. Let $n \in \mathbf{N}$. Clearly, $\alpha(C_{2n}) = \beta_1(C_{2n}) = n$, so that, by Proposition 2.6.4, $\eta(C_{2n}) = \alpha(C_{2n}) = n$. Let $G \cong C_{2n+1}$ and let $e = uv \in E(G)$. Then $\alpha(E(G) - \{e\}, G) = n < n + 1 = \alpha(C_{2n+1})$, so that $E(G)$ is the only α -forcing set of G , and $\eta(C_{2n+1}) = q(C_{2n+1}) = 2n + 1$. \square

Corollary 2.6.6. *For any bipartite graph G , $\eta(G) = \alpha(G)$.*

Proof. König showed that $\beta_1(G) = \alpha(G)$ for every bipartite graph G (see [CL86]). \square

Corollary 2.6.7. *For every tree T , $\eta(T) = \alpha(T)$.*

Proposition 2.6.8. *For any graph G with no isolated vertices, $\alpha(G) \geq \gamma(G)$.*

That equality does not, in general, hold in Proposition 2.6.8 is illustrated by Proposition 2.6.9.

Proposition 2.6.9. *For any $n \in \mathbf{N}$, there exists a (connected) graph G satisfying $\alpha(G) - \gamma(G) = n$.*

Proof. Let $n \in \mathbf{N}$ and consider the wheel $W(2n)$ on $2n$ spokes. Clearly, a set consisting of a maximum independent set of $W(2n)$, together with the central vertex of $W(2n)$, forms a smallest cover of G , so that $\alpha(G) = n + 1$; obviously, $\gamma(G) = 1$. \square

We recall that a nonempty graph G satisfies $\eta(G) = q(G)$ if and only if $\alpha(F, G) < \alpha(G)$ for every $F \subset E(G)$. In particular, a nonempty graph G satisfying $\eta(G) = q(G)$ has the property that $\alpha(G - e) < \alpha(G)$ for every $e \in E(G)$. This suggests the following definition.

Definition 2.6.3. A nonempty graph G is said to be α -minimal if $\alpha(G - e) < \alpha(G)$ for each edge e of G . So, G is α -minimal if and only if $\eta(G) = q(G)$.

Examples 2.6.10. 1. Any cycle of odd order is α -minimal, by the proof of Corollary 2.6.5.

2. For any $m \in \mathbf{N}$, the graph mK_2 is α -minimal.

3. By our comments in Example 2.6.1. 3, any complete graph is α -minimal.

2.7 Edge-Domination by Edges

Our concepts of domination-forcing sets and covering-forcing sets in section A and B, respectively, were based on the idea of a set of vertices of a graph G dominating a set of vertices, namely $V(G)$, and a set of vertices of a graph G dominating a set of edges, namely $E(G)$. We now turn our attention naturally to sets of *edges* that dominate the edge set of a graph. This concept may be motivated as follows. Consider that we have constructed a graph H that models a street grid (in the natural way), with a view to assigning police cars or officers to patrol the streets of the city. Suppose that the police relax the condition that a police officer be present in every “street block” (i.e., edge in H) and instead require simply to find a smaller set F of street-blocks to which to assign patrol cars/police officers whose task it will be to travel back and forth along the street-block and, at each end, look up each of the “adjacent” street-blocks not actually patrolled. The set U of edges of H that the police have to locate, then, is one such that each edge of H *not* in U is adjacent to an edge in U . Let $\gamma'(H)$ denote the cardinality of the smallest such set U . However, if we let G' be the line graph $\mathcal{L}(H)$ of H , we notice that $\gamma'(H) = \gamma(G')$. This essentially brings us back to the problems discussed in Sections 2.1 and 2.2, and so we will not pursue further the topic of edge-domination by edges.

Chapter 3

Aspects of n -Distance Domination

3.1 Introduction

In [BHNS83], Bauer et al. introduced the idea of μ -stability, which, for an arbitrary parameter μ of a graph G , is the minimum number of vertices in a set $S \subseteq V(G)$ such that $\mu(G - S) \neq \mu(G)$. More specifically, for a parameter μ for which there exist $S_1, S_2 \subseteq V(G)$ with $\mu(G - S_1) > \mu(G)$ and $\mu(G - S_2) < \mu(G)$, the parameters $\mu^+(G)$ and $\mu^-(G)$ were defined, where $\mu^+(G) = \min\{|S|; \mu(G - S) > \mu(G), S \subseteq V(G)\}$ and $\mu^-(G) = \min\{|S|; \mu(G - S) < \mu(G), S \subseteq V(G)\}$. In [BHNS83], Bauer et al. continued with an investigation of γ -stability, γ^+ and γ^- . Similar notions gave rise to the parameters $\gamma^{+'}(G) = \min\{|F|; \mu(G - F) > \mu(G), F \subseteq E(G)\}$ and $\gamma^{-'}(G) = \min\{|F|; \mu(G - F) < \mu(G), F \subseteq E(G)\}$ for a graph G ; results on these parameters were given in [FJKR91] and [HR94]. Also along the lines of consideration of the domination number of a graph with vertices removed, Brigham, Chinn and Dutton ([BCD84], [BCD88]) investigated vertex-domination-critical graphs, which are graphs G with the property that $\gamma(G - v) < \gamma(G)$ for every vertex $v \in V(G)$. What we do in the first section of this chapter is generalize some of the work of [BHNS83] by considering the effect on the n -distance domination number of the removal of vertices.

Definition 3.1.1. Let G be a graph, $D \subseteq V(G)$, $n \in \mathbf{N}$, and $u, v \in V(G)$. The set D n -distance dominates the graph G (abbreviated by $D \xrightarrow{n} G$) or is an n -distance dominating set of G if, for each $x \in V(G)$, there exists $x' \in D$ such that $d_G(x, x') \leq n$. If it is not true that $D \xrightarrow{n} G$, we write $D \not\xrightarrow{n} G$. If D is a smallest n -distance dominating set of G (abbreviated by $D \xrightarrow{n, \min} G$), then D is called a *minimum n -distance dominating set* of G and its size will be denoted in this thesis by $\gamma_n(G)$, the n -distance domination number of G . (In [MM75], Meir and Moon used $C_n(G)$)

to denote the n -distance domination number of G .) If it is not true that $D \xrightarrow{n, \min} G$, we write $D \not\xrightarrow{n, \min} G$. Furthermore, if $d_G(u, v) \leq n$, then we shall say that u is an n -distance neighbour (or, more briefly, an n -neighbour) of v ; also, $N_G^n[v]$ will denote the set $\{y \in V(G); d_G(y, v) \leq n\}$, called the *closed n -neighbourhood of v* and $N_G^n(v)$ the set $N_G^n[v] - \{v\}$, called the *open n -neighbourhood of v* . Finally, if $v \in D$ and $u \in V(G) - D$, we say that u is a *private n -neighbour* of v if $N_G^n(u) \cap D = \{v\}$.

3.2 The integrity of n -distance-domination

Parameters $\gamma^+(G)$, the minimum number of vertices whose removal from G produces a graph H with $\gamma(H) > \gamma(G)$, and $\gamma^-(G)$, the minimum number of vertices whose removal from G produces a graph H with $\gamma(H) < \gamma(G)$, were introduced by Bauer et al in [BHNS83]. We define now analogous parameters for the more general concept of n -distance domination.

Definition 3.2.1. Let G be a graph and let $n \in \mathbf{N}$. If there exists a subset S of $V(G)$ such that $\gamma_n(G - S) > \gamma_n(G)$ ($\gamma_n(G - S) < \gamma_n(G)$, respectively), then $\gamma_n^+(G)$ ($\gamma_n^-(G)$, respectively) is defined to be the size of a smallest such set S ; otherwise, we define $\gamma_n^+(G)$ ($\gamma_n^-(G)$, respectively) to be $p(G)$. We shall say that S is a $\gamma_n^+(G)$ -set (a $\gamma_n^-(G)$ -set, respectively) if $|S| = \gamma_n^+(G)$ and $\gamma_n(G - S) > \gamma_n(G)$ (if $|S| = \gamma_n^-(G)$ and $\gamma_n(G - S) < \gamma_n(G)$, respectively).

While it is true that the n -distance domination number of a graph is equal to the (1-distance-)domination number of the n^{th} power of that graph, it is a simple matter to verify that, in general, for a vertex v of a graph G and $n \geq 2$, $G^n - v \not\cong (G - v)^n$ (consider, for example, a path), whence $\gamma_n(G - v) = \gamma((G - v)^n) \neq \gamma(G^n - v)$. This observation motivates our study of the difference $|\gamma_n(G - S) - \gamma_n(G)|$ for subsets S of vertices of graphs G .

As a means of shortening the text, we shall say that the removal of a set S of vertices from a graph G has decreased (or increased, respectively) the n -distance domination number when we mean that the removal of the set S from G has resulted in a graph H with $\gamma_n(H) < \gamma_n(G)$ (or $\gamma_n(H) > \gamma_n(G)$, respectively).

As well as a generalized domination parameter γ_n , we can define a generalized total domination parameter γ_n^t as follows.

Definition 3.2.2. For an integer $n \geq 2$, a set D of vertices of a graph is defined to be a *total n -distance dominating set* of G if every vertex v in G is at distance at most n from at least one vertex in $D - \{v\}$. The *total n -distance domination number*, $\gamma_n^t(G)$, of a graph G is the minimum cardinality of a total n -distance dominating set of G .

Some general bounds on γ_n and γ_n^t are to be found in [HOS91] as follows.

Theorem 3.2.1 (Henning, Oellermann, Swart [HOS91]). *Let $n \in \mathbf{N}$ and let G be a graph, of order p . Then*

1. *If $p \geq n + 1$ and G is connected, then $\gamma_n(G) \leq \frac{p}{n+1}$.*
2. *If $n \geq 2$ and G is connected, then $\gamma_n^t(G) \begin{cases} = 2 & \text{if } 2 \leq p \leq 2n + 1 \\ \leq \frac{2p}{2n+1} & \text{if } p \geq 2n + 1. \end{cases}$*
3. *If $p \geq n + 1 \geq 3$ and G and \bar{G} are both connected, then*

$$\begin{aligned} 2 \leq \gamma_n(G) + \gamma_n(\bar{G}) &\leq \frac{p}{n+1} + 1, \\ 1 \leq \gamma_n(G) \cdot \gamma_n(\bar{G}) &\leq \frac{p}{n+1}, \\ \gamma_n^t(G) + \gamma_n^t(\bar{G}) &= 4 && \text{if } p \leq 2n + 1, \\ 4 \leq \gamma_n^t(G) + \gamma_n^t(\bar{G}) &\leq \frac{2p}{2n+1} + 2 && \text{if } p \geq 2n + 2, \\ \gamma_n^t(G) \cdot \gamma_n^t(\bar{G}) &= 4 && \text{if } p \leq 2n + 1, \text{ and} \\ 4 \leq \gamma_n^t(G) \cdot \gamma_n^t(\bar{G}) &\leq \frac{4p}{2n+1} && \text{if } p \geq 2n + 2. \end{aligned}$$

4. *If $p \geq n + 1 \geq 3$ and neither G nor \bar{G} has isolated vertices, then*

$$\gamma_n^t(G) + \gamma_n^t(\bar{G}) \leq p + 2,$$

and

$$\gamma_n^t(G) \cdot \gamma_n^t(\bar{G}) \leq 2p.$$

The following definitions will be useful for our first two results.

Definition 3.2.3. Let G be a graph, $n \in \mathbf{N}$, $A \subseteq V(G)$ with $A \xrightarrow{n, \min} G$, and $v \in A$. We define the set $A_n^*(v)$ of private n -neighbours of v in $V(G) - A$ by

$$A_n^*(v) = \{u \in V(G) - A; N_G^n(u) \cap A = \{v\}\}.$$

Furthermore, we define

$$m_n(G) = \min\{|A_n^*(v)|; A \xrightarrow{n, \min} G, v \in A\}.$$

Note that, for a graph G and $n \in \mathbb{N}$, $m_n(G) = 0$ if and only if there exists A , $A \xrightarrow{n, \min} G$, and $v \in A$ such that $A_n^*(v) = \emptyset$, i.e., such that $A - \{v\} \xrightarrow{n} G - v$ and (since A is a *minimum* n -distance dominating set) $A \cap N_G^n(v) = \emptyset$ (i.e., the only vertex of G *not* n -distance dominated by $A - \{v\}$ is v). Observe also that the definitions of $A_n^*(v)$ and $m_n(G)$ yield immediately the upper bound $p(G) - \gamma_n(G)$ for $m_n(G)$, which is attained by, for example, the graphs obtained from any star by the subdivision $n - 1$ times of each edge. In fact, we have the following.

Proposition 3.2.2. *Let $n \in \mathbb{N}$ and let G be a graph without isolated vertices. Then $m_n(G) \leq p(G) - \gamma_n(G)$ with equality if and only if $\gamma_n(G) = 1$.*

Proof. Let $n \in \mathbb{N}$ and let G be a graph with $\delta(G) \geq 1$. If $\gamma_n(G) = 1$, then $D_n^*(v) = V(G) - D$ for every minimum n -distance dominating set $D = \{y\}$ of G , so that $m_n(G) = |V(G) - D| = p(G) - \gamma_n(G)$. For the converse, suppose that $\gamma_n(G) = k \geq 2$, and let $A \xrightarrow{n, \min} G$. Note that, since G has no isolated vertices, $\gamma_n(G) < p(G)$. So, if $A_n^*(v_0) = \emptyset$ for some $v_0 \in A$, then $m_n(G) = 0 < p(G) - \gamma_n(G)$ and we are done. So, suppose $A_n^*(v) \neq \emptyset$ for each of the $k \geq 2$ vertices v of A . Then, since the sets $A_n^*(v)$, $v \in A$, are mutually disjoint and are subsets of $V(G) - A$, it follows that $|A_n^*(v)| < p(G) - \gamma_n(G)$ for each $v \in A$, and $m_n(G) \leq \min\{|D_n^*(v)|; v \in D, D \xrightarrow{n, \min} G\} < p(G) - \gamma_n(G)$. \square

We now present an upper bound for $\gamma_n^-(G)$ in terms of $m_n(G)$.

Proposition 3.2.3. *For any graph G and $n \in \mathbb{N}$, $\gamma_n^-(G) \leq m_n(G) + 1$.*

Proof. Let $n \in \mathbb{N}$, let G be a graph, and let $A \xrightarrow{n, \min} G$, $v \in A$ be such that $m_n(G) = |A_n^*(v)|$. Now, $A - \{v\} \xrightarrow{n} G - A_n^*(v) - v$, i.e., $\gamma_n(G - A_n^*(v) - v) \leq |A - \{v\}| < \gamma_n(G)$. So, $\gamma_n^-(G) \leq |A_n^*(v) \cup \{v\}| = m_n(G) + 1$. \square

The upper bound in Proposition 3.2.3 is sharp: Construct a (connected) graph G as follows. Let $k, t \in \mathbb{N}$ with $t \geq 3$ and let $C : w_1, w_2, \dots, w_{k(2n+1)+t}$ be a $(k(2n+1)+t)$ -cycle. Let $v, z_0, z_1, \dots, z_{k-1}$ be $k + 1$ new vertices; for i , $0 \leq i \leq k - 1$, join z_i and $w_{n+1+i(2n+1)}$ by an edge and subdivide this edge $n - 1$ times. Finally, for each j , $k(2n + 1) + 1 \leq j \leq k(2n + 1) + t$, join v and w_j by an edge and subdivide this edge $n - 1$ times. Since $A = \{w_{n+1+i(2n+1)}; 0 \leq i \leq k - 1\} \cup \{v\} \xrightarrow{n, \min} G$,

$\gamma_n(G) = k + 1$. Furthermore, for i , $0 \leq i \leq k - 1$, $|A_n^*(w_{n+1+i(2n+1)})| = 3n$ and $|A_n^*(v)| = nt$, so that $m_n(G) = \min\{3n, nt\} = 3n$. Also, since, for any i , $0 \leq i \leq k - 1$, $\gamma_n(G - A_n^*(w_{n+1+i(2n+1)}) - \{w_{n+1+i(2n+1)}\}) = \gamma_n(G) - 1$, and $\gamma_n(G - A_n^*(v) - \{v\}) = \gamma_n(G) - 1$, it follows that $\gamma_n^-(G) = \min\{|A_n^*(w_{n+1+i(2n+1)})| + 1, |A_n^*(v)| + 1; 0 \leq i \leq k - 1\} = 3n + 1 = m_n(G) + 1$.

Proposition 3.2.3 provides a characterization of graphs G having $\gamma_n^-(G) = 1$, as follows.

Corollary 3.2.4. *For any graph G and $n \in \mathbf{N}$, $\gamma_n^-(G) = 1$ if and only if $m_n(G) = 0$.*

Proof. Let G be any graph and $n \in \mathbf{N}$. If $m_n(G) = 0$, then $\gamma_n^-(G) = 1$ follows from the last proposition. Conversely, if $\gamma_n^-(G) = 1$, let $v \in V(G)$ such that $\gamma_n(G - v) < \gamma_n(G)$ and $B \xrightarrow{n, \min} G - v$, then $B \xrightarrow{n} N_G^n(v)$ (and $B \not\xrightarrow{n} v$), so that $B \cup \{v\} \xrightarrow{n, \min} G$ and $(B \cup \{v\})_n^*(v) = \emptyset$. So $m_n(G) = 0$. \square

We can (simultaneously) prescribe $\gamma_n, \gamma_n^-, \gamma_n^+$, as the next proposition shows.

Proposition 3.2.5. *Given $n, k, t, \ell \in \mathbf{N}$ with $k \geq 3$, there exists a graph G with $\gamma_n(G) = k$, $\gamma_n^-(G) = \ell$, and $\gamma_n^+(G) = t$.*

Proof. Let $n, k, t, \ell \in \mathbf{N}$ with $k \geq 3$; let $m \in \mathbf{N}$ be such that $m > t$ and $2m > \ell$; let $F \cong K_\ell$. For $0 \leq i \leq 2n$, $1 \leq j \leq k - 1$, $(i, j) \neq (1, 1)$, let $G_{i,j} \cong K_m$; let $G_{1,1} \cong K_t$. For $0 \leq i \leq n$, let $G'_{i,k-1} \cong G_{i,k-1}$. For $1 \leq j \leq k - 2$, let $H_j = G_{0,j} + G_{1,j} + G_{2,j} + \cdots + G_{2n,j}$. Let $H'_{k-1} = G_{0,k-1} + G_{1,k-1} + G_{2,k-1} + \cdots + G_{2n,k-1} + F$. Let $H''_{k-1} = G'_{0,k-1} + G'_{1,k-1} + G'_{2,k-1} + \cdots + G'_{n,k-1}$. Let H_{k-1} be obtained from H'_{k-1} and H''_{k-1} by the identification of the vertices of $G_{n,k-1}$ and $G'_{n,k-1}$. Let $G''' = \left(\bigcup_{j=1}^{k-2} H_j\right) \cup H_{k-1}$ (see Figure 3.1). Then,

$$\begin{aligned}\gamma_n(G''') &= k \\ \gamma_n^+(G''') &= t\end{aligned}$$

and

$$\gamma_n^-(G''') = \min\{(2n + 1)m, 2m, \ell\} = \ell.$$

\square

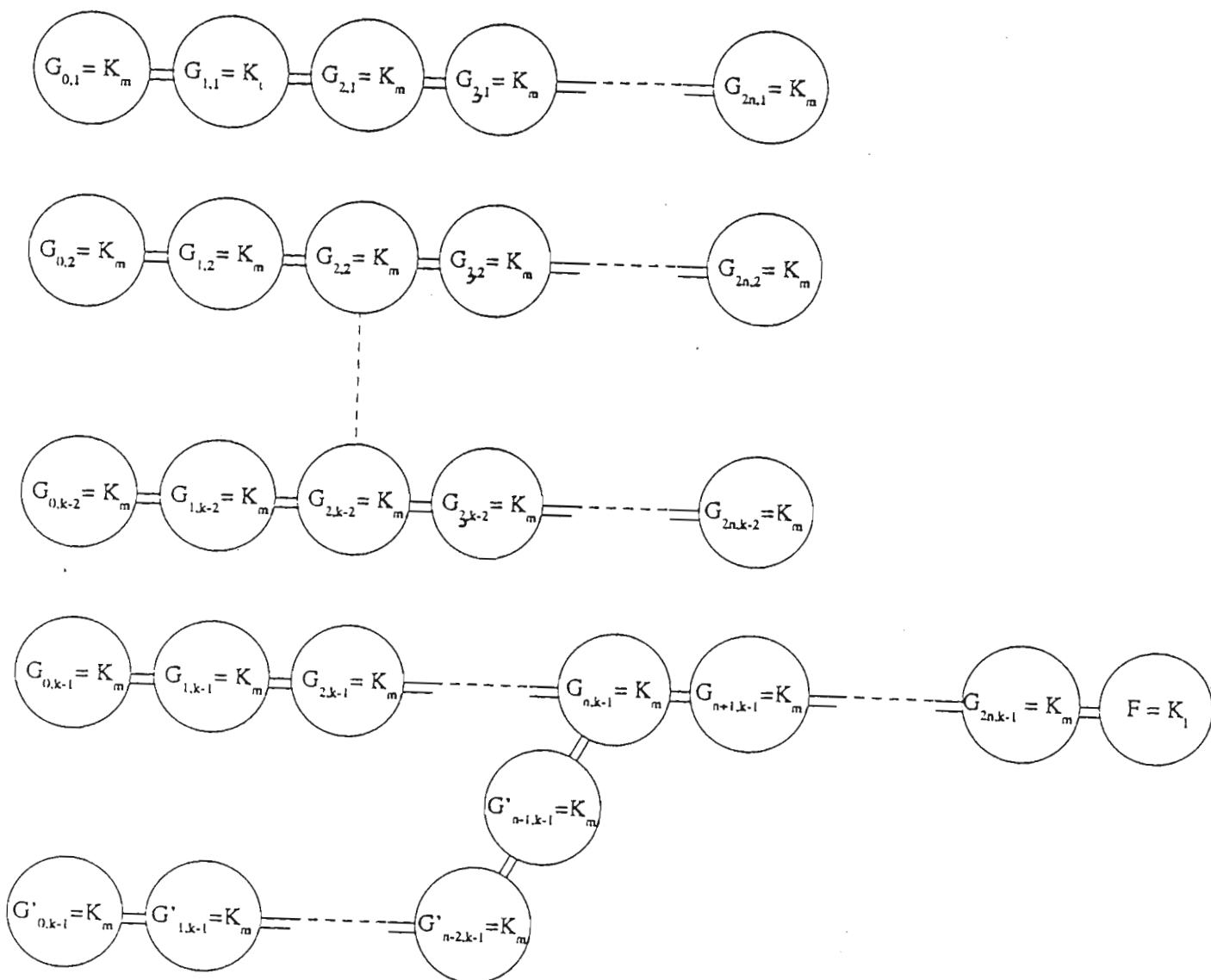

Figure 3.1: The graph G''' of Proposition 3.2.5

For the graph G''' described in the previous proposition, the $\gamma_n^+(G)$ -set $V(G_{1,1})$ has the property that $\gamma_n(H - V(G_{1,1})) - \gamma_n(H) = 1$. In the following proposition, we describe a family of graphs F for which we can prescribe the difference $\gamma_n(F - T) - \gamma_n(F)$ for a $\gamma_n^+(F)$ -set T , as well as the value of $\gamma_n^+(F)$.

Proposition 3.2.6. *Given $n, \ell, t \in \mathbf{N}$ with $\ell \geq 2$, there exists a graph G with $\gamma_n^+(G) = t$ and a t -set S of G such that $\gamma_n(G - S) - \gamma_n(G) = \ell$.*

Proof. Let $\ell, t, n \in \mathbf{N}$. For $1 \leq j \leq \ell + 1$, $1 \leq i \leq n$, let $G_{0,j} \cong K_t$, $G_{i,j} \cong K_{t+1}$, and let $H_j = G_{0,j} + G_{1,j} + \dots + G_{n,j}$. Finally, form H from $H_1, H_2, \dots, H_{\ell+1}$ by identifying the vertices in $G_{0,j}$, $1 \leq j \leq \ell + 1$ to form a set V_0 of t vertices. Then, $\gamma_n(H) = 1$ and a smallest vertex-cutset is V_0 . So, $\gamma_n^+(H) = t$ and $\gamma_n(H - V_0) = \ell + 1$. \square

That the difference $\gamma_n(G - S) - \gamma_n(G)$, where $n \in \mathbf{N}$, G is a graph, and S is a $\gamma_n^-(G)$ -set, cannot be made arbitrarily large is shown by the next theorem, which shows that, if $n \in \mathbf{N}$ and $T \subseteq V(G)$ is minimal such that $\gamma_n(G - T) < \gamma_n(G)$ for a graph G , then in fact $\gamma_n(G - T) = \gamma_n(G) - 1$. First, we introduce the following definition.

Definition 3.2.4. Let $n \in \mathbf{N}$, let G be a graph, and let $v \in V(G)$. Then, v is an n -distance-domination-critical vertex of G (or, briefly, an n -critical vertex of G) if $\gamma_n(G - v) < \gamma_n(G)$.

Lemma 3.2.7. *For any $n \in \mathbf{N}$, graph G , $v \in V(G)$, and any subset S of $N_G[v]$ containing v , $\gamma_n(G - S) \geq \gamma_n(G) - 1$.*

Proof. For $n \in \mathbf{N}$, G a graph, v a vertex of G , $S \subseteq N_G[v]$ with $v \in S$, and any $D \xrightarrow{n, \min} G - S$, we have $D \cup \{v\} \xrightarrow{n} G$, whence $\gamma_n(G) \leq \gamma_n(G - S) + 1$. \square

Corollary 3.2.8. *For any $n \in \mathbf{N}$, graph G , n -critical vertex v of G and any subset S of $N_G[v]$ containing v , $\gamma_n(G - S) = \gamma_n(G) - 1$.*

Proof. Let $n \in \mathbf{N}$, let G be a graph with an n -critical vertex v of G and $S \subseteq N_G[v]$, $v \in S$. If $D \xrightarrow{n, \min} G - v$, then $|D| = \gamma_n(G) - 1$ (by Lemma 3.2.7) and $N_G^n[v] \cap D = \emptyset$ (otherwise, $D \xrightarrow{n} G$). Thus, $D \subseteq V(G) - N_G^n[v]$ and so $D \subseteq V(G) - S$. Since $D \xrightarrow{n} G - S$, $\gamma_n(G - S) \leq |D| = \gamma_n(G) - 1$. By Lemma 3.2.7, the desired result follows. \square

Theorem 3.2.9. *Let $n \in \mathbf{N}$, let G be a graph, and let W be a minimal set of vertices of G such that $\gamma_n(G - W) < \gamma_n(G)$. Then, $\gamma_n(G - W) = \gamma_n(G) - 1$ and $\gamma_n(G - Y) = \gamma_n(G)$ for any $(|W| - 1)$ -subset Y of W .*

Proof. Let $n \in \mathbf{N}$, let G be a graph and let W be a minimal subset of $V(G)$ for which $\gamma_n(G - W) < \gamma_n(G)$. Let Y be any $(|W| - 1)$ -subset of W . Then, for $\{u\} = W - Y$, it follows, by our choice of W and Y that $\gamma_n(G - Y) \geq \gamma_n(G)$ and that u is an n -critical vertex of $G - Y$. So, by Corollary 3.2.7,

$$\gamma_n(G - Y) - 1 \leq \gamma_n((G - Y) - u) \leq \gamma_n(G) - 1 \leq \gamma_n(G - Y) - 1, \quad (3.2.1)$$

whence the desired results follow. \square

That, for any $n, k \in \mathbf{N}$, graphs G with $v \in V(G)$ exist for which $\gamma_n(G - v) - \gamma_n(G) \geq k$ may be seen by considering any star $K_{1,k+1}$ with central vertex v .

The final result of this section gives an upper bound on $\gamma_n^+(G)$ or $\gamma_n^-(G)$.

Proposition 3.2.10. *For all $n \in \mathbf{N}$ and graphs G , $\min\{\gamma_n^+(G), \gamma_n^-(G)\} \leq \delta(G) + 1$.*

Proof. Let $n \in \mathbf{N}$ and let G be a graph. Let v be a vertex of minimum degree in G . If $G \cong K_p$, then, by definition, $\gamma_n^+(G) = \gamma_n^-(G) = p(G) = \delta(G) + 1$. Suppose now that $G \not\cong K_p$; then $N_G[v] \neq V(G)$. If $\gamma_n(G - N_G[v]) > \gamma_n(G)$, $\gamma_n^+(G) \leq \delta(G) + 1$, and if $\gamma_n(G - N_G[v]) < \gamma_n(G)$, $\gamma_n^-(G) \leq \delta(G) + 1$. In either case, $\min\{\gamma_n^+(G), \gamma_n^-(G)\} \leq \delta(G) + 1$. If $\gamma_n(G - N_G[v]) = \gamma_n(G)$, then $\gamma_n(G - N_G(v)) = \gamma_n(\{v\} \cup (G - N_G[v])) = 1 + \gamma_n(G - N_G[v]) > \gamma_n(G)$; so $\gamma_n^+(G) \leq \delta(G)$ and $\min\{\gamma_n^+(G), \gamma_n^-(G)\} \leq \delta(G) + 1$ holds immediately. \square

3.3 n -Distance-Domination-Forcing Sets of Graphs

The concept of packings in a graph was generalized to n -packings by Meir and Moon [MM75].

Definition 3.3.1. For $n \in \mathbf{N}$, $v \in V(G)$ and $S \subseteq V(G)$, S is said to be an n -packing of G if $N_G^n[v] \cap S = \{v\}$ for every vertex v in S , i.e., if $d_G(v, u) > n$ for every pair u, v of distinct vertices in S . An n -packing of G of maximum cardinality is said to be a *maximum n -packing* of G and its cardinality, denoted by $P_n(G)$, is called the

n -packing number of G .

Let S and T be subsets of $V(G)$ and H a subgraph of G ; then T is said to be an n -distance dominating set of S (or H) in G (equivalently, T n -distance dominates S (or H) in G) if $S \subseteq N_G^n[T]$ (or $V(H) \subseteq N_G^n[T]$). This is expressed symbolically by $T \xrightarrow{n} S$ (or $T \xrightarrow{n} H$), and, for brevity, T is also known as an S - (or H -) n -distance dominating set in G . If $S \not\subseteq N_G^n[T]$ (or $V(H) \not\subseteq N_G^n[T]$), then we write $T \not\xrightarrow{n} S$ (or $T \not\xrightarrow{n} H$). An S - n -distance dominating set in G of minimum cardinality is known as a *minimum S - n -distance dominating set* in G and its cardinality, denoted by $\gamma_n(S, G)$, as the *S - n -distance domination number* in G .

Let $n \in \mathbf{N}$ and $S \subseteq V(G)$; we denote by $\pi(G, S, n)$ the set of all paths in G , of length at most n , between pairs of (not necessarily distinct) vertices in S . The subgraph H of G , defined by letting $V(H) = \bigcup\{V(P); P \in \pi(G, S, n)\}$ and $E(H) = \bigcup\{E(P); P \in \pi(G, S, n)\}$, will be denoted by $\langle S, n \rangle_G$.

For $k, \ell \in \mathbf{N}$, recall that $S(k, \ell)$ denotes the double star obtained from the disjoint union of stars $K_{1,k}$ and $K_{1,\ell}$ with central vertices u and v , respectively, by the insertion of the edge uv . Furthermore, for $m, n \in \mathbf{N}$, $S_{m,n}(k, \ell)$ denotes the graph obtained from $S(k, \ell)$ by subdividing each edge of $K_{1,k} \cup K_{1,\ell}$ $m - 1$ times and the edge uv $n - 1$ times.

Examples 3.3.1. (a) For any $n, p \in \mathbf{N}$ the graph G obtained from K_p by subdividing each edge at most $\lfloor \frac{n}{2} \rfloor$ ($n \geq 2$) times is such that $\gamma_n(T, G) = 1 = \gamma_n(G)$ for any $\emptyset \neq T \subseteq V(G)$. In fact, $\gamma_n(T, H) = 1 = \gamma_n(H)$ for any graph H , and any $T \subseteq V(H)$, if $\text{diam}(H) \leq n$.

(b) Let $m, n \in \mathbf{N}$ with $2 \leq m \leq n$, and let $G \cong K_{m,n}$ with partite sets V_1 and V_2 ; let $\emptyset \neq T \subseteq V(G)$ and let $k \in \mathbf{N}$. Recall that, if $k = 1$, then $\gamma_k(T, G) = 2 = \gamma_k(G)$ if $|T \cap V_i| \geq 2$ for each $i \in \{1, 2\}$ and $\gamma_k(T, G) = 1$, otherwise. If $k \geq 2$, then $\gamma_k(T, G) = 1 = \gamma_k(G)$ for any $\emptyset \neq T \subseteq V(G)$.

Notice that the above example shows that, for any $n \in \mathbf{N}$, there exists a graph G having proper subsets T of $V(G)$ for which $\gamma_n(T, G) = \gamma_n(G)$.

(c) Let $n \in \mathbf{N}$, and let G be any graph containing vertices u and v such that $n < d_G(u, v) \leq 2n$. Let x be any vertex of G with $d_G(u, x), d_G(v, x) \leq n$. Then, $T = \{u, v\}$ is such that $\langle T, n \rangle_G = \langle T \rangle_G \cong \bar{K}_2$ so that $\gamma_n(\langle T, n \rangle_G) = \gamma_n(\langle T \rangle_G) = \gamma(\langle T \rangle_G) = 2$. On the other hand, $\{x\} \xrightarrow{n} T$. So, $\gamma_n(T, G) = 1 < \gamma_n(\langle T, n \rangle_G)$.

It is possible to extend results pertaining to the domination-forcing number to the n -distance-domination-forcing number. For ease of reading, we supply full details in the remainder of this chapter.

Definition 3.3.2. Let G be a graph and let $n \in \mathbf{N}$. A set $S \subseteq V(G)$ for which $\gamma_n(S, G) = \gamma_n(G)$ is called an n -distance-domination-forcing set of G or (briefly) a γ_n -forcing set of G . (Clearly, such a set S exists for every graph G and every $n \in \mathbf{N}$ since $\gamma_n(V(G), G) = \gamma_n(G)$.) An n -distance-domination-forcing set of G of minimum cardinality is known as a $\theta_n(G)$ -set and its cardinality, denoted by $\theta_n(G)$, is called the n -distance-domination-forcing number (or, more briefly, γ_n -forcing number) of G .

Examples 3.3.2. (d) For any graph G with $\text{diam}(G) \leq n$, $\gamma_n(G) = 1$, and for any $\emptyset \neq T \subseteq V(G)$, $\gamma_n(T, G) = 1$; in particular, this holds for T a singleton, so $\theta_n(G) = 1$.

(e) Let $m, n, k \in \mathbf{N}$ with $2 \leq m \leq n$ and let $G \cong K_{m,n}$. If $k = 1$, then $\gamma_k(G) = 2$ and $\theta_k(G) = 4$ (see Example 3.3.1). If $k \geq 2$, then clearly $\gamma_k(G) = 1$ and $\theta_k(G) = 1$.

(f) If $p, n \in \mathbf{N}$, then $V(G)$ is the only γ_n -forcing set of \bar{K}_p and $\theta_n(\bar{K}_p) = p$.

(g) Clearly, for $n, k \in \mathbf{N}$, we have $\gamma_n(P_1) = 1$ and $\gamma_n(P_k) = \left\lceil \frac{k-1}{2n} \right\rceil$ for $k \geq 2$. We will show later that $\theta_n(P_k) = \gamma_n(P_k)$ for all $n, k \in \mathbf{N}$.

It is immediately obvious that, for any graph G , $n \in \mathbf{N}$, and $S \subseteq V(G)$, $\gamma_n(S, G) \leq \min\{\gamma_n(G), \gamma_n(\langle S, n \rangle_G)\}$. In Examples (a) – (f), each graph G has the property that, for any $n \in \mathbf{N}$ and any $\theta_n(G)$ -set S , $\gamma_n(\langle S, n \rangle_G) = \gamma_n(S, G)$ ($= \gamma_n(G)$). That this property is not possessed by every graph is shown by the following example, in which is exhibited a graph G and a $\theta_n(G)$ -set S for which $\gamma_n(\langle S, n \rangle_G) > \gamma_n(S, G)$ ($= \gamma_n(G)$).

Example 3.3.3. (h) Let $n \in \mathbf{N}$ and let $G \cong C_{3n+3}$. For any $v \in V(G)$, $e(v) = \left\lfloor \frac{3n+3}{2} \right\rfloor = n+1 + \left\lfloor \frac{n+1}{2} \right\rfloor > n$; thus, no 1-subset of $V(G)$ n -distance-dominates G , and $\gamma_n(G) \geq 2$. However, the end-vertices of any diametral path of G clearly n -distance-dominate G ; so, $\gamma_n(G) = 2$. We now determine $\theta_n(G)$. Since the eccentricity of any vertex of G is $n+1 + \left\lfloor \frac{n+1}{2} \right\rfloor \leq 2n$, it follows that, for any two distinct vertices u, v of G , $d_G(u, v) \leq 2n$, and there exists a vertex $w \in V(G)$ with $d_G(w, v), d_G(w, u) \leq n$, i.e., $\{w\} \xrightarrow{n} \{u, v\}$. So, $\theta_n(G) \geq 3$. We now

exhibit a 3-subset S of $V(G)$ with $\gamma_n(S, G) = 2$ and $|S| = 3$. Suppose $G : u_0, u_1, \dots, u_{3n+2}, u_0$ and let $S = \{u_0, u_{n+1}, u_{2n+2}\}$. Assume that $\gamma_n(S, G) = 1$ and that $\{x\} \xrightarrow{n} S$; let $i \in \{0, 1, \dots, 3n+2\}$ be the index such that $x = u_i$. In particular, $\{x\} \xrightarrow{n} \{u_0, u_{n+1}\}$, so we must have $i \in \{0, 1, \dots, n+1\}$ (otherwise, $d(x, u_0) > n$ or $d_G(x, u_{n+1}) > n$). However, a similar argument using the fact that $\{x\} \xrightarrow{n} \{u_{n+1}, u_{2n+2}\}$ shows $i \in \{n+1, n+2, \dots, 2n+2\}$; this is not possible. So, $\gamma_n(S, G) \geq 2$; since $\{u_1, u_{2n+2}\} \xrightarrow{n} S$, we have $\gamma_n(S, G) = 2 = \gamma_n(G)$, and S is a γ_n -forcing set. Hence, by our earlier inequality, $\theta_n(G) = 3$ and S is a $\theta_n(G)$ -set. Notice that $\gamma_n(\langle S, n \rangle_G) = \gamma_n(\overline{K_3}) = 3 > 2 = \gamma_n(S, G)$.

Before going on to investigate the relationship between $\theta_n(G)$ and $\gamma_n(G)$ for a graph G and $n \in \mathbb{N}$, we introduce the notion of efficiency for n -distance dominating sets. For $n \in \mathbb{N}$, an n -distance dominating set D of a graph G is said to be efficient if, for any $v \in V(G)$, $d_G(v, d) \in \{0, 1, \dots, n\}$ for exactly one element d of D , i.e. if every vertex of G is n -distance dominated by a unique vertex of D .

Now, let $n \in \mathbb{N}$ and let G be a graph with an efficient n -distance dominating set D ; then, for every two distinct vertices u and v of D , we have $d_G(u, v) > n$ and, for every vertex w of G that satisfies $d_G(u, w) \leq n$, we have $d_G(v, w) > n$. Hence, each vertex in any D - n -distance dominating set in G n -distance dominates at most one vertex of D ; hence, if D' is a minimum D - n -distance dominating set in G , we have $\gamma_n(D, G) = |D'| \geq |D|$. Since the set D n -distance dominates itself, we have $\gamma_n(D, G) \leq |D|$, whence it follows that $\gamma_n(D, G) = |D|$. Consequently, since $\gamma_n(D, G) \leq \gamma_n(G) \leq |D|$, we have that the efficient n -distance dominating set D is a minimum n -distance dominating set in G .

Proposition 3.3.4. *For any graph G and $n \in \mathbb{N}$,*

- (1) $\gamma_n(G) \leq \theta_n(G)$, and
- (2) $\gamma_n(G) = \theta_n(G)$ if G has an efficient n -distance dominating set.

Proof. Let G be any graph and let $n \in \mathbb{N}$. We first prove (1). If $S \subseteq V(G)$ and $|S| < \gamma_n(G)$, then $\gamma_n(S, G) \leq \gamma_n(\langle S, n \rangle_G) \leq |S| < \gamma_n(G)$, and S is not a $\theta_n(G)$ -set. Hence, for any $\theta_n(G)$ -set S , $\theta_n(G) = |S| \geq \gamma_n(G)$.

To prove (2), suppose that G has an efficient n -distance dominating set D ; then $\gamma_n(D, G) = |D| = \gamma_n(G)$ (by our preceding remarks). Hence, D is a γ_n -forcing set of G and $\theta_n(G) \leq |D| = \gamma_n(G)$, which, with (1), yields $\gamma_n(G) = \theta_n(G)$. \square

That the (sufficient) condition given in the above proposition is not necessary to ensure equality between the γ_n -forcing number and the n -distance domination number of a graph can be seen by consideration of a graph $G \cong S_{n,n}(m, m)$ for any $n, m \in \mathbf{N}$ with $m \geq 2$. Denote the two vertices of degree $\Delta(G)$ by u and v . The only minimum n -distance dominating set of G is $D = \{u, v\}$ and, for any two vertices x and y in G satisfying $d(x, y) \geq 2n+1$, we have $S = \{x, y\}$ satisfying $\gamma_n(S, G) = 2 = \gamma_n(G) = |S|$, whence S is a $\theta_n(G)$ -set and $\theta_n(G) = 2 = \gamma_n(G)$. However, D is certainly not an efficient n -distance dominating set of G (since $d_G(u, v) \leq n$), and so, by our previous remark, *no* n -distance dominating set of G is efficient.

We shall show next that, for any given positive integers j, t with $j < t$, there exists a graph G for which $\gamma_n(G) = 2$, $\theta_n(G) - \gamma_n(G) = j$ and $p(G) - \theta_n(G) \geq 2t + 1$.

Definition 3.3.3. For $n, j, t \in \mathbf{N}$ with $t \geq j + 1$, let $m = \binom{t}{j}$ and define the graph $J(t, j; n)$ to be the graph obtained from the graph $J_{t,j}$ defined in Example 2.2.4 by subdividing $n - 1$ times every edge in $[V(J_1), V(J_2)]$ and $[V(J_2), \{w\}]$.

Proposition 3.3.5. For $n, t, j \in \mathbf{N}$, $t \geq j + 1$ and $G \cong J(t, j; n)$,

- (1) $\gamma_n(G) = 2$,
- (2) $\theta_n(G) = j + 2 = \gamma_2(J(t, j; n)) + j$,
- (3)
$$\begin{aligned} p(G) &= t + \binom{t}{j} [(n - 1)(j + 1) + 1] + 1 \\ &\geq [\theta_n(G) - 1][1 + \binom{t}{j}(n - 1)] + \binom{t}{j} + 1. \end{aligned}$$

Proof. Let t, j, n and G satisfy the hypotheses of the proposition, respectively, and assume that the vertices of G are labelled as in the definition of $J(t, j; n)$.

- (1) We show first that $\gamma_n(G) > 1$. Notice that $e_G(w) = 2n$, $e_G(v_i) = n + 1$ for all $i = 1, 2, \dots, m$; $e_G(u_j) = 2n$ for all $j = 1, 2, \dots, t$ and $e_G(x) \geq n + 1$ for any $x \in V(G) - (J_1 \cup J_2 \cup J_3)$. So, every vertex of G has eccentricity greater than n in G , which implies that no single vertex of G n -distance dominates G . So, $\gamma_n(G) \geq 2$. Since $\{u_1, w\} \xrightarrow{n} G$, we have $\gamma_n(G) = 2$.
- (2) Let $B \subseteq V(G)$ such that $|B \cap V(J_1)| \leq j$. Then, there exists $k \in \{1, 2, \dots, m\}$ such that $B \cap V(J_1) \subseteq A_k$; consequently, $\{v_k\} \xrightarrow{n} B$ and $\gamma_n(B, G) = 1$. Hence, it follows that, if S is a $\theta_n(G)$ -set (so, $\gamma_n(S, G) = 2$), then $|S \cap V(J_1)| \geq j + 1$. Furthermore, $S \not\subseteq V(J_1)$ (since, otherwise, $\{u_1\} \xrightarrow{n} S$); so $S - V(J_1) \neq \emptyset$ and

$\theta_n(G) = |S| \geq j + 1 + |S - V(J_1)| \geq j + 2$. To show that $\theta_n(G) \leq j + 2$, we let $T = \{u_1, u_2, \dots, u_{j+1}, w\}$. Then, $\gamma_n(T, G) \geq 2$, as can be seen as follows. If there exists $y \in V(G)$ with $\{y\} \xrightarrow{n} T$, then $y \notin V(J_2) \cup V(J_3)$ (as no vertex in $V(J_2) \cup V(J_3)$ is within distance n from $j + 1$ vertices in $V(J_1)$) and so $y \in V(J_1)$ whence $\{y\} \not\xrightarrow{n} \{w\}$, contradicting $\{y\} \xrightarrow{n} T$. Since $\{u_1, w\} \xrightarrow{n} T$, we have $\gamma_n(T, G) = 2 = \gamma_n(G)$ and T is a γ_n -forcing set of G , whence $\theta_n(G) \leq |T| = j + 2$. Hence, $\theta_n(G) = j + 2$.

$$\begin{aligned}
(3) \quad p(G) &= t + \binom{t}{j} + (n-1) \cdot j \cdot \binom{t}{j} + \binom{t}{j} \cdot (n-1) + 1 \\
&= t + \binom{t}{j} [1 + j(n-1) + (n-1)] + 1 \\
&= t + \binom{t}{j} [(n-1)(j+1) + 1] + 1 \\
&\geq j + 1 + \binom{t}{j} [(n-1)(j+1) + 1] + 1 \\
&= (j+1) [1 + \binom{t}{j} (n-1)] + \binom{t}{j} + 1.
\end{aligned}$$

So,

$$p(G) \geq [\theta_n(G) - 1] [1 + \binom{t}{j} (n-1)] + \binom{t}{j} + 1.$$

□

In the above example, $\gamma_n(J(t, j; n)) = 2$. We shall show that, for prescribed $k \geq 2$, $n, M, N \in \mathbf{N}$, there exists a graph G for which $\gamma_n(G) = k$, $\theta_n(G) - \gamma_n(G) = (k-1)(j+1) + 1 - k = j(k-1) \geq N$ and

$$\begin{aligned}
p(G) - \gamma_n(G) &= (k-1) [t + \binom{t}{j} (n-1)(j+1)] + k - 1 + \binom{t}{j} \\
&\quad - (k-1)(j+1) - 1 \\
&= (k-1) [t + \binom{t}{j} (n-1)(j+1) - j] - 1 \geq M.
\end{aligned}$$

Definition 3.3.4. For $t, j, k, n \in \mathbf{N}$ with $k \geq 2, t \geq j, m = \binom{t}{j}$, let $G_1, G_2, \dots, G_{k-1} \cong J(t, j; n)$ and, in G_i , let $V_{1i}, V_{2i}, u_{1i}, u_{2i}, \dots, u_{ti}, v_{1i}, v_{2i}, \dots, v_{mi}$ and w_i correspond to $V(J_1), V(J_2), u_1, u_2, \dots, u_t, v_1, v_2, \dots, v_m$ and w , respectively, in $J(t, j; n)$ for $i = 1, 2, \dots, k-1$. Let $J_k(t, j; n)$ be the graph obtained from G_1, G_2, \dots, G_{k-1}

by identifying the vertices $v_{i1}, v_{i2}, \dots, v_{i(k-1)}$ to form a new vertex v_i^k corresponding to the vertex $v_i \in V(J_2)$ in $J(t, j; n)$, for $i = 1, 2, \dots, m$. Denote the resulting set $\{v_1^k, v_2^k, \dots, v_m^k\}$ by V_2^k , and the subset of V_{1i} corresponding to A_ℓ by $A_{\ell i}$ ($i \in \{1, 2, \dots, k-1\}$, $\ell \in \{1, \dots, m\}$). (Note that $J_2(t, j; n) = J(t, j; n)$.)

Proposition 3.3.6. *For $t, j, k, n \in \mathbf{N}$ with $k \geq 2$, $t \geq (k-1)jn + 1$, $m = \binom{t}{j}$ and $G \cong J_k(t, j; n)$, we have*

- (1) $\gamma_n(G) = k$,
- (2) $\theta_n(G) = (k-1)(j+1) + 1$, and
- (3) $p(G) = (k-1) \left[t + \binom{t}{j} (n-1)(j+1) + 1 \right] + \binom{t}{j}$.

Proof. Let n, t, j, k and G satisfy the hypothesis of the proposition; assume that the vertices of G are labelled as in Definition 3.3.3. For ease of notation, for each $i \in \{1, 2, \dots, k-1\}$, let I_i denote the set of all internal vertices of paths joining a vertex of V_{1i} and a vertex of V_2^k .

- (1) That $\gamma_n(G) \leq k$ follows from the observation that $\{v_1^k, u_{11}, u_{12}, \dots, u_{1(k-1)}\} \xrightarrow{n} G$. If there exists an n -distance dominating set D of G with $|D| \leq k-1$, then $D \not\subseteq \bigcup_{i=1}^{k-1} (V_{1i} \cup I_i)$ (otherwise, $D \xrightarrow{n} \{w_1, w_2, \dots, w_{k-1}\}$; hence, $D \cap (V_{1\ell} \cup I_\ell) = \emptyset$ for at least one value of $\ell \in \{1, 2, \dots, k-1\}$). So, $V_\ell \cup I_\ell$ is n -distance dominated by (at most $k-1$) vertices in $D \cap V_2^k$; however,

$$|N_G(D \cap V_2^k) \cap (V_{1\ell} \cup I_\ell)| \leq |D \cap V_2^k|jn \leq (k-1)jn < t = |V_{1\ell}| \leq |V_{1\ell} \cup I_\ell|,$$

so that $D \cap V_2^k \xrightarrow{n} V_{1\ell} \cup I_\ell$ is impossible. Hence, any n -distance dominating set of G has cardinality at least k . So, $\gamma_n(G) = k$.

- (2) Let S be a $\theta_n(G)$ -set. Suppose $|S \cap \bigcup_{i=1}^{k-1} (V_{1i} \cup I_{1i})| < (k-1)(j+1)$. Then, for at least one $i_0 \in \{1, 2, \dots, k-1\}$, we have $|S \cap (V_{1i_0} \cup I_{i_0})| \leq j$. Let $\ell \in \{1, 2, \dots, m\}$ be such that $S \cap V_{1i_0} \subseteq A_{\ell i_0}$. Notice that every vertex of I_{i_0} is within distance n of $v_{i_0}^k$. Let $i_1, i_2, \dots, i_r \in \{1, 2, \dots, k-1\}$ be the indices i for which $S \cap (V_{1i} \cup I_i) \neq \emptyset$ and $i \neq i_0$. Then (since $u_{1i_v} \xrightarrow{n} I_{i_v}$ for $v, 1 \leq v \leq r$), clearly $T = \{v_{i_0}^k\} \cup \{u_{1i_v}; 1 \leq v \leq r\} \xrightarrow{n} S$, whence $\gamma_n(S, G) \leq |T| \leq k-1$, a contradiction.

So,

$$|S \cap \bigcup_{i=1}^{k-1} (V_{1i} \cup I_i)| \geq (k-1)(j+1).$$

Furthermore, $S \not\subseteq \bigcup_{i=1}^{k-1} (V_{1i} \cup I_i)$, since, otherwise, $\{u_{1v}; 1 \leq v \leq k-1\} \xrightarrow{n} S$ (contrary to $\gamma_n(G) = k$). So,

$$|S| > |S \cap \bigcup_{i=1}^{k-1} (V_{1i} \cup I_i)| \geq (k-1)(j+1),$$

i.e., $\theta_n(G) \geq (k-1)(j+1) + 1$.

For $i = 1, 2, \dots, k-1$, define $U_i = \{u_{vi}; 1 \leq v \leq j+1\}$. Then, clearly, for $U = \bigcup_{i=1}^{k-1} U_i$, $\gamma_n(U, G) = k-1$, the set $\{u_{1v}; 1 \leq v \leq k-1\}$ being a minimum U - n -distance dominating set in G . In fact, the set $U \cup \{w_1\}$ constitutes a set S_0 of cardinality $(k-1)(j+1) + 1$ that has $\gamma_n(S_0, G) = k$. So, $\theta_n(G) \leq (k-1)(j+1) + 1$, and the desired result follows.

(3)

$$\begin{aligned} p(G) &= (k-1)t + \binom{t}{j} + \binom{t}{j}(k-1)j(n-1) + \binom{t}{j}(n-1)(k-1) + (k-1) \\ &= (k-1) \left[t + \binom{t}{j}j(n-1) + \binom{t}{j}(n-1) + 1 \right] + \binom{t}{j} \\ &= (k-1) \left[t + \binom{t}{j}(n-1)(j+1) + 1 \right] + \binom{t}{j}. \end{aligned}$$

□

3.3.1 Graphs for which $\theta_n(G) = \gamma_n(G)$

The following result is obvious.

Proposition 3.3.7. *If $n \in \mathbb{N}$ and graphs F, G and H satisfy $F \subset G \subset H$, then $\gamma_n(F, H) \leq \gamma_n(F, G)$.*

Proposition 3.3.8. *For every $n \in \mathbb{N}$ and every tree T , $\theta_n(T) = \gamma_n(T)$.*

Proof. Let $n \in \mathbb{N}$ and let T be any tree. If \mathcal{P} is a maximum $2n$ -packing of T , then, by a result of Meir and Moon [MM75], $|\mathcal{P}| = \gamma_n(T)$. Clearly, $\gamma_n(\mathcal{P}, T) = |\mathcal{P}| = \gamma_n(T)$, so that \mathcal{P} is a γ_n -forcing set of T . Thus, $\theta_n(T) \leq |\mathcal{P}| = \gamma_n(T)$. However, $\theta_m(G) \geq \gamma_m(G)$ for every graph G and $m \in \mathbb{N}$. Hence, $\theta_n(T) = \gamma_n(T)$. □

Corollary 3.3.9. *For $n \in \mathbb{N}$ and T a tree, any maximum $2n$ -packing of T is a $\theta_n(T)$ -set.*

Proposition 3.3.10. *For any $n \in \mathbf{N}$ and any graph G , $P_{2n}(G) \leq \gamma_n(G)$.*

Proof. Let $n \in \mathbf{N}$ and let G be a graph. Let D be an n -distance dominating set of G and P a $2n$ -packing of G . Say, $D = \{d_1, d_2, \dots, d_m\}$, $P = \{p_1, p_2, \dots, p_k\}$. Let $R = P \cap D$. Then, for every vertex p in $P - R$, there is a vertex, say d_p , in $D - R$ such that $d(p, d_p) \leq n$. Clearly, though, by the definition of a $2n$ -packing, $d_p \neq d_{p'}$ for distinct $p, p' \in P - R$. So, $|P - R| \leq |D - R|$; hence, $|P| \leq |D|$. Since P and D are an arbitrary $2n$ -packing and n -distance dominating set, respectively, the result follows. \square

Proposition 3.3.11. *If $n \in \mathbf{N}$ and G is a graph for which $\gamma_n(G) = \theta_n(G)$, then any $\theta_n(G)$ -set is a $2n$ -packing, and hence $P_{2n}(G) \geq \theta_n(G) = \gamma_n(G)$, so that $P_{2n}(G) = \gamma_n(G)$.*

Proof. Let $n \in \mathbf{N}$, let G be a graph for which $\gamma_n(G) = \theta_n(G)$, and suppose there is a $\theta_n(G)$ -set S and vertices $u, v \in S$ with $d_G(u, v) \leq 2n$. Then, for a vertex x of G with $d_G(u, x), d_G(v, x) \leq n$, we have $(S - \{u, v\}) \cup \{x\} \xrightarrow{n} S$, which implies $\gamma_n(S, G) \leq |S| - 1 < |S| = \theta_n(G) = \gamma_n(G) = \gamma_n(S, G)$, an absurdity. So, no such $\theta_n(G)$ -set exists, and the desired result follows. \square

Proposition 3.3.12. *If $n \in \mathbf{N}$ and G is a graph for which $P_{2n}(G) = \gamma_n(G)$, then $\theta_n(G) = \gamma_n(G)$.*

Proof. Let $n \in \mathbf{N}$, let G be a graph for which $P_{2n}(G) = \gamma_n(G)$, and let S be a $2n$ -packing of G with $|S| = \gamma_n(G)$. The proof now proceeds as the last part of the proof of Proposition 3.3.8. \square

Corollary 3.3.13. *Let $n \in \mathbf{N}$ and let G be a graph. Then, $\theta_n(G) = \gamma_n(G)$ if and only if $P_{2n}(G) = \gamma_n(G)$.*

We remark, as an aside, that there exist graphs G which satisfy $P_{2n}(G) = \gamma_n(G)$, but which have the property that no maximum $2n$ -packing of G has a single vertex in common with a maximum n -distance dominating set of G . For example, for $m, n, \ell \in \mathbf{N}$ with $2 \leq m \leq \ell$, let $G \cong S_{n,n}(m, \ell)$, and let $\{u, v\}$ be the set of vertices of G of degree $\Delta(G)$; as mentioned before, $\{u, v\}$ is the only minimum n -distance dominating set of G . If u or v belongs to a $2n$ -packing P of G , then $|P| = 1$; however, in fact, $P_{2n}(G) = 2$ (for example, any set consisting of an end-vertex at distance n from u and an end-vertex at distance n from v is a $2n$ -packing of G). On the other

hand, there also exist graphs G with $P_{2n}(G) = \gamma_n(G)$ that possess an n -distance dominating set that is a $2n$ -packing (in other words (by Proposition 3.3.10) a *minimum* n -distance dominating set that is simultaneously a *maximum* $2n$ -packing); for example, consider a graph $H \cong S_{n,2n+1}(m, \ell)$, where the two vertices of degree $\Delta(H)$ constitute a $2n$ -packing of H that is also an n -distance dominating set of H .

We consider this simple observation.

Observation. Let $n \in \mathbb{N}$ and let G be a graph. If any of the two quantities $\gamma_n(G)$, $\theta_n(G)$, $P_2(G)$ are equal, then the third quantity equals the first two.

We close this section by looking at n -distance-critical vertices.

Definition 3.3.5. Let $n \in \mathbb{N}$, let G be a graph and let $v \in V(G)$. Then, we define v to an n -distance-critical vertex of G if $\gamma_n(G - v) < \gamma_n(G)$. If every vertex of G is an n -distance-critical vertex of G , we say that G is an n -distance-domination-critical graph.

The next proposition reveals that the graphs G for which the upper bound on $\theta_n(G)$, namely $p(G)$, is actually attained are precisely the n -distance-domination-critical graphs.

Proposition 3.3.14. For a graph G and $n \in \mathbb{N}$, $\theta_n(G) = p(G)$ if and only if G is n -distance-domination-critical.

Proof. Let $n \in \mathbb{N}$ and let G be a graph. Suppose first that $\theta_n(G) = p(G)$. Let $v \in V(G)$ and let $S = V(G) - \{v\}$. Since $|S| < p(G) = \theta_n(G)$, it follows that $\gamma_n(S, G) < \gamma_n(G)$, i.e. there is some set $T \subseteq V(G)$ with $|T| < \gamma_n(G)$ such that $T \xrightarrow{n} \langle S \rangle_G = G - v$. Thus, $\gamma_n(G - v) < \gamma_n(G)$. Since v is an arbitrary vertex of G , the n -distance-domination-criticality of G follows.

Conversely, suppose G is n -distance-domination-critical. Let $\emptyset \neq S \subset V(G)$ and let $v \in V(G) - S$. By the n -distance-domination-criticality of G , there is a subset $T \subseteq V(G) - \{v\}$ such that $|T| < \gamma_n(G)$ and $T \xrightarrow{n} G - v$. So, since $S \subset V(G) - \{v\}$, we have $T \xrightarrow{n} S$ and $\gamma_n(S, G) \leq |T| < \gamma(G)$. Hence, the only n -distance-forcing set of G is $V(G)$, and $\theta_n(G) = p(G)$ follows. \square

3.3.2 More Graphs with Prescribed Parameters

In the following two propositions, we investigate further the possibility of prescribing the values of $\theta_n(G)$ and $\gamma_n(G)$ for a graph G .

Lemma 3.3.15. *For any $n \in \mathbb{N}$ and for any graph G of order p and n -distance domination number γ_n , there exists a graph H with $p(H) = p + \gamma_n$ and $\theta_n(H) = \gamma_n(H) = \gamma_n$.*

Proof. Let $n \in \mathbb{N}$, let G be any graph of order p and n -distance domination number γ_n , and let D be a minimum n -distance dominating set of G . Let $V(G) = \{v_1, v_2, \dots, v_p\}$ and, without loss of generality, suppose that $D = \{v_1, v_2, \dots, v_{\gamma_n}\}$. We produce a new graph H from G by adding γ_n new vertices $u_1, u_2, \dots, u_{\gamma_n}$ and joining the vertex u_i to the vertex v_i by a path P_i of length n ($1 \leq i \leq \gamma_n$) such that $V(P_i) \cap V(P_j) = \emptyset$ for distinct $i, j \in \{1, 2, \dots, \gamma_n\}$.

Now, notice that, for no pair u, v of distinct vertices in the set $S = \{u_1, u_2, \dots, u_{\gamma_n}\}$ does there exist a vertex $x \in V(G)$ with $d(u, x), d(v, x) \leq n$. Hence, if T is any S - n -distance dominating set in H , then each vertex of T n -distance dominates at most one vertex of S and we have that $|T| \geq |S|$; and thus $\gamma_n(S, H) \geq |S|$. However, $S \xrightarrow{n} S$, whence $\gamma_n(S, H) \leq |S|$. Thus, $\gamma_n(S, H) = |S| = \gamma_n$. That $\gamma_n(H) = \gamma_n$ follows from $\gamma_n(H) \leq \gamma_n$ (since $D \xrightarrow{n} H$) and $\gamma_n(H) \geq \gamma_n(S, H) = \gamma_n$.

Thus it follows that $\gamma_n(S, H) = \gamma_n(H)$, i.e., S is a γ_n -forcing set. So, $\theta_n(H) \leq |S| = \gamma_n = \gamma_n(H)$. Since $\theta_n(F) \geq \gamma_n(F)$ for all graphs F , we have $\theta_n(H) = \gamma_n(H) = \gamma_n$, as required. \square

Proposition 3.3.16. *Given any $n, \gamma_n, p \in \mathbb{N}$ with $p \geq \gamma_n$, there exists a graph H with $p(H) = p$ and $\gamma_n(H) = \gamma_n = \theta_n(H)$.*

Proof. Let $n, p, \gamma_n \in \mathbb{N}$ with $p \geq \gamma_n$. If $p = \gamma_n$, let $H \cong \bar{K}_p$ and H has the required properties. If $\gamma_n < p \leq (2n+1)\gamma_n$, then let H be the union of γ_n paths, each of order at most $2n+1$, such that the order of H is p . Then, clearly, $\theta_n(H) = \gamma_n = \gamma_n(H)$. Suppose now that $p > (2n+1)\gamma_n$. Let $p' = p - \gamma_n$, and define a graph G by $G \cong F \cup T$, where T is any tree with $\gamma_n(T) = 1$ and $F \cong \bigcup_{i=1}^{\gamma_n-1} P_{b_i}$, where $1 \leq b_i \leq 2n+1$ for each $i \in \{1, 2, \dots, \gamma_n\}$ and $\sum_{i=1}^{\gamma_n-1} b_i + p(T) = p'$. Then, $p(G) = p'$ and $\gamma_n(G) = \gamma_n$, and, by the previous proposition, there is a graph H (obtainable from G) with $\gamma_n(H) = \gamma_n = \theta_n(H)$ and $p(H) = p' + \gamma_n = p$. \square

We end this section by presenting and proving the values of $\theta_2(G)$ for all cycles G . The results for θ_1 were given in Theorem 2.4.3.

Theorem 3.3.17. *Let $m \in \mathbf{N}$ with $m \geq 3$. Then*

$$\theta_2(C_m) = \begin{cases} \frac{m}{5} = \gamma_2(C_m) & \text{if } m \equiv 0 \pmod{5} \\ m & \text{if } m \equiv 1 \pmod{5} \\ \frac{1}{5}(3m - 1) & \text{if } m \equiv 2 \pmod{5} \\ \frac{1}{5}(2m - 1) & \text{if } m \equiv 3 \pmod{5} \\ \frac{1}{5}(2m - 3) & \text{if } m \equiv 4 \pmod{5}. \end{cases}$$

Proof. Let $m \in \mathbf{N}$ with $m \geq 3$, and let $C_m : u_0, u_1, \dots, u_m (= u_0)$. By inspection, the results are easily seen to hold for m satisfying $3 \leq m \leq 7$, so we assume now that $m \geq 8$. Suppose first that $m \equiv 0 \pmod{5}$. Clearly, $D = \{u_0, u_5, u_{10}, \dots, u_{m-5}\}$ is a 4-packing of C_m , and hence $\gamma_2(D, C_m) = |D| = \frac{m}{5} = \gamma_2(C_m)$; so (by Proposition 3.3.12), $\theta_2(C_m) = \gamma_2(C_m) = \frac{m}{5}$ follows.

Suppose now that $m \equiv 1 \pmod{5}$. Let $\emptyset \neq R \subset V(C_m)$. Clearly, $\langle R \rangle_{C_m} \subset C_m - v$ for some $v \in V(C_m)$. Hence, $\gamma_2(R, C_m) \leq \gamma_2(R, C_m - v) \leq \gamma_2(C_m - v) = \frac{m-1}{5} < \left\lceil \frac{m}{5} \right\rceil = \gamma_2(C_m)$. Thus, $\theta_2(C_m) = p(C_m) = m$.

Suppose now that $m \equiv 2 \pmod{5}$; say, $m = 5k + 2$ for some $k \in \mathbf{N}$. (So, $k \geq 2$.) Let $S = \{u_{5i}, u_{5i+2}, u_{5i+3}; 0 \leq i \leq k-1\} \cup \{u_{5k}\}$. Then, $|S| = 3k + 1$. If $T \subseteq V(C_m)$ and $T \xrightarrow{2} S$, then each vertex in T 2-distance dominates (at most) three vertices of S , and so $|T| \geq \left\lceil \frac{1}{3}|S| \right\rceil = k + 1$. Since $D = \{u_{5i+1}; 0 \leq i \leq k\} \xrightarrow{2} S$, we have $\gamma_2(S, C_m) \leq |D| = k + 1$. Hence, $\gamma_2(S, C_m) = k + 1 = \gamma_2(C_m)$; so, S is a γ_2 -forcing set of C_m and $\theta_2(C_m) \leq |S| = 3k + 1 = \frac{1}{5}(3m - 1)$.

To show that $\theta_2(C_m) = 3k + 1$, we assume that a γ_2 -forcing set R of C_m exists with $|R| \leq 3k$. Let $T = V(C_m) - R$; then $t = |T| \geq (5k + 2) - 3k = 2k + 2$, and T contains at least one vertex—without loss of generality, assume $u_0 \in T$.

We note that there exists no subset $\{x, y\}$ of T such that $d_G(x, y) \equiv 1 \pmod{5}$. (Otherwise, if such a set exists; then $C_m - \{x, y\}$ is either a path P' of order $5k$ with $R \subseteq V(P')$ so that $\gamma_2(R, C_m) \leq \gamma_2(P') = k < \gamma_2(C_m)$, or the union of two paths P_1 and P_2 where $R \subseteq V(P_1) \cup V(P_2)$, $p(P_1) + p(P_2) = 5k$, $p(P_1) \equiv 0 \pmod{5}$ and $p(P_2) \equiv 0 \pmod{5}$, so that $\gamma_2(R, C_m) \leq \gamma_2(R \cap P_1, P_1) + \gamma_2(R \cap P_2, P_2) = k <$

$\gamma_2(C_m)$, a contradiction.) Hence, since we have assumed $u_0 \in T$, we must have $R_1 = \{u_{5i+1}; 0 \leq i \leq k\} \subseteq R$. Further, since no component of $\langle T \rangle$ is non-trivial, we have that, for each $i \in \{0, 1, \dots, k-1\}$, $|\{u_j; 5i+2 \leq j \leq 5i+5\} \cap R| \geq 2$. However, then $|R| \geq |R_1| + 2k = 3k + 1$, which is contrary to our assumption that $|R| \leq 3k$. Hence, $\theta_2(C_m) = 3k + 1 = \frac{1}{5}(3m - 1)$, as required.

Suppose next that $m \equiv 3 \pmod{5}$; say, $m = 5k + 3$ for some $k \in \mathbf{N}$. Let $S = \{u_0\} \cup \{u_{5i+3}, u_{5i+6}; 0 \leq i \leq k-1\}$. Then, any vertex of C_m 2-distance dominates at most two vertices of S , so that $\gamma_2(S, C_m) \geq \left\lceil \frac{1}{2}|S| \right\rceil = \left\lceil \frac{2k+1}{2} \right\rceil = k + 1$. Since $D = \{u_{5i+2}; 0 \leq i \leq k\}$ 2-distance dominates S , we have $\gamma_2(S, C_m) \leq k + 1$, so that, finally, $\gamma_2(S, C_m) = k + 1 = \gamma_2(C_m)$ and we have that S is a γ_2 -forcing set of C_m . Thus, $\theta_2(C_m) \leq |S| = 2k + 1$.

We show now that $\theta_2(C_m) \geq 2k + 1$. Suppose that there exists a γ_2 -forcing set R of C_m with $|R| \leq 2k$. As before, let $T = V(C_m) - R$; then $|T| \geq 3k + 3$.

We observe that there exists no subset $\{u, v, w\}$ of T such that $\langle \{u, v\} \rangle \cong K_2$ and $d(\{u, v\}, 2) \equiv 1 \pmod{5}$. (Otherwise if such a set exists, then $C_m - \{u, v, w\}$ is either a path P' of order $5k$ with $R \subseteq V(P')$ and $\gamma_2(R, C_m) \leq k < \gamma_2(C_m)$, or the union of two paths P_1 and P_2 where $R \subseteq V(P_1) \cup V(P_2)$, $p(P_1) + p(P_2) = 5k$, $p(P_1) \equiv 0 \pmod{5}$ and $p(P_2) \equiv 0 \pmod{5}$, so that $\gamma_2(R, C_m) \leq \gamma_2(R \cap P_1, P_1) + \gamma_2(R \cap P_2, P_2) \leq k < \gamma_2(C_m)$, a contradiction.) In particular, then, $\langle T \rangle$ has no component of order 3 or more.

Now, T is clearly not independent, since, otherwise $|T| \leq \beta(C_m) = \left\lfloor \frac{5k+3}{2} \right\rfloor$, contrary to the fact that $|T| \geq 3k + 3$. So, $\langle T \rangle$ has at least one component of order 2; without loss of generality, suppose that $\{u_0, u_1\}$ is the vertex set of this component. Then, in light of the result proved in the previous paragraph, we must have $R_1 = \{u_{5i+2}; 0 \leq i \leq k\} \subseteq R$. Now, since $\langle T \rangle$ has no (path) component of order 4, we must have, for each $i \in \{0, 1, \dots, k-1\}$, $|\{u_j; 5i+3 \leq j \leq 5i+6\} \cap R| \geq 1$. However, then $|R| \geq |R_1| + k = 2k + 1$, which is contrary to our assumption that $|R| \leq 2k$.

Suppose, finally, that $m \equiv 4 \pmod{5}$; say, $m = 5k + 4$ for some $k \in \mathbf{N}$. Let $S = \{u_3\} \cup \{u_{5i}, u_{5i+3}; 1 \leq i \leq k\}$. Clearly, any vertex of C_m 2-distance dominates at most two vertices of S , so that $\gamma_2(S, C_m) \geq \left\lceil \frac{1}{2}|S| \right\rceil = \left\lceil \frac{2k+1}{2} \right\rceil = k + 1$. Since $D = \{u_0\} \cup \{u_{5i-1}, 1 \leq i \leq k\} \xrightarrow{2} S$, we have $\gamma_2(S, C_m) \leq |D| = k + 1$. Hence, $\gamma_2(S, C_m) = k + 1 = \gamma_2(C_m)$, so, S is a γ_2 -forcing set of C_m and $\theta_2(C_m) \leq |S| = 2k + 1$.

To show that $\theta_2(C_m) = 2k + 1$, we assume that a γ_2 -forcing set R of C_m exists with $|R| \leq 2k$. Let $T = V(C_m) - R$; then, $|T| \geq (5k + 4) - 2k = 3k + 4$. We observe that there exists no subset $\{a, b, c, d\}$ of T such that $\langle \{a, b\}, \{c, d\} \rangle \cong K_2$ and $d(\{a, b\}, \{c, d\}) \equiv 1 \pmod{5}$, or $\langle \{a, b, c\} \rangle \cong P_3$ and $d(\{a, b, c\}, d) \equiv 1 \pmod{5}$. So, certainly, no component of T has order 4 or more. Certainly, T is not independent (otherwise, $3k + 4 \leq |T| \leq \left\lfloor \frac{5k+4}{2} \right\rfloor = 2k + 2 + \left\lfloor \frac{k}{2} \right\rfloor$).

We consider two cases.

Case 1: Suppose T contains a component isomorphic to P_3 ; without loss of generality, suppose that $\{u_0, u_1, u_2\}$ is the vertex set of this component. Then, we must have $R_1 = \{u_{5i+3}; 0 \leq i \leq k\} \subset R$. Since $\langle T \rangle$ has no components of order 4, we have, for each $i \in \{0, 1, \dots, k-1\}$, $|\{u_j; 5i+4 \leq j \leq 5i+7\} \cap R| \geq 1$. However, then $|R| \geq |R_1| + k = 2k + 1$, contrary to our assumption that $|R| \leq 2k$.

Case 2: Suppose that every component of $\langle T \rangle$ has order 1 or 2. Since T is not independent, $\langle T \rangle$ has at least one component of order 2; without loss of generality, suppose that $\{u_0, u_1\}$ is the vertex set of this component. Then, for each $i \in \{0, 1, \dots, k\}$, $\{u_{5i+2}, u_{5i+3}\} \cap R \neq \emptyset$. Since $\langle T \rangle$ has no component of order 3, we have, for each $i \in \{0, 1, \dots, k-1\}$, $|\{u_j; 5i+4 \leq j \leq 5i+6\} \cap R| \geq 1$. However, then $|R| \geq k + \sum_{i=0}^k |\{u_{5i+2}, u_{5i+3}\} \cap R| \geq 2k + 1$, a contradiction. \square

Thus the sensitivity of the parameter γ_n to subdivision or contraction of an edge is revealed: For any $k \in \mathbf{N}$, the cycles C_{5k} and C_{5k+1} satisfy $p(C_{5k+1}) - p(C_{5k}) = 1$, $\gamma_n(C_{5k+1}) - \gamma_n(C_{5k}) = \left\lfloor \frac{5k+1}{2n+1} \right\rfloor - \left\lfloor \frac{5k}{2n+1} \right\rfloor \leq 1$, yet $\theta_n(C_{5k+1}) - \theta_n(C_{5k}) = 4k + 1$.

Chapter 4

Radius-Forcing Sets in Graphs

4.1 Introduction

Let G be a connected graph of order p and vertex set $V(G)$. Suppose that the vertices of G represent p facilities in which essential data or materials are storeable (for example, warehouses, rooms, computers in an information network). Two vertices in G are joined by an edge if the corresponding facilities are linked or adjacent or somehow “close” to each other. Suppose that it has been determined that, for some $k \in \mathbf{N}$, if a disaster or failure of some kind occurs at a facility (represented by a vertex v , say), then all facilities represented by vertices at distance at most $k - 1$ from v will be jeopardized. The problem at hand now is to select the smallest possible subset of $V(G)$ so that, if our essential material is stored in the facilities corresponding to this subset, then our system, in the most economical way, has the property that our material, or information, is retrievable from somewhere in the system even in the case when an arbitrary facility fails. One option, of course, is to design G to have radius at least k and to store all essential data in *each* facility, but this is an expensive option. However, if $\text{rad}(G) \geq k$ and if S is a smallest subset of $V(G)$ with the property that, for each $w \in V(G)$, there exists $w' \in S$ such that $d_G(w, w') \geq k$, then selecting the $|S|$ facilities represented by S as the set of facilities at which to store our essential data will produce a choice that may be considerably cheaper, but which still provides the required security. In the first five sections of this chapter, we deal with the specific case $k = \text{rad}(G)$; in the two sections that follow, we consider general k .

Definition 4.1.1. Let G be a (connected) graph, let $a, v \in V(G)$ and $A, S \subseteq V(G)$. We define the generalized *eccentricity* $e_G(a, S)$ of a with respect to S in G by

$$e_G(a, S) = \max\{d_G(a, s); \quad s \in S\}$$

and the *radius* $\text{rad}(S, G)$ of S in G by

$$\text{rad}(S, G) = \min\{e_G(v, S); \quad v \in V(G)\}.$$

We say that S is a *k-radius-forcing set* of G if $\text{rad}(S, G) \geq k$; the size of a smallest *k-radius-forcing set* is denoted by $\rho_k(G)$ and called the *k-radius-forcing number* of G . A $\text{rad}(G)$ -radius-forcing set of G will be referred to more briefly as a *radius-forcing set* of G .

Notice that $\rho(G)$, the size of a smallest set S with $\text{rad}(S, G) = \text{rad}(G)$, can be seen as the smallest number of vertices in a subset S of $V(G)$ such that each vertex of G is at distance at least $\text{rad}(G)$ from some vertex in S .

In [Faj88], Fajtlowicz introduced the class of graphs called *r-ciliates* and the following notion of *r-criticality*.

Definition 4.1.2. For $a, b \in \mathbb{N}$ with $p \geq 3$, let $C_{b,a}$ be a graph obtained from b disjoint copies of P_{a+1} by linking together one end-vertex of each in a cycle C_b . For $r, a \in \mathbb{N}$ with $r \geq a$, the graphs $C_{2a, r-a}$ are called *r-ciliates*. A graph is *r-critical* if it has radius r and every proper induced connected subgraph has radius strictly smaller than r .

Finally, for a connected graph G of radius r , we define the graph G^* to be the graph given by $V(G^*) = V(G)$ and $uv \in E(G^*)$ if and only if $d_G(u, v) \geq r$. Notice that this graph G^* provides a link between total domination and radius-forcing number since, by the definition of ρ , $\gamma_t(G^*) = \rho(G)$. Furthermore, it is not difficult to see that $G^* = \overline{G^{\text{rad}(G)-1}}$. (This graph is a generalization, in a sense, of the antipodal graph $A(G)$ of a graph G defined by R. R. Singleton [Sin68], where $A(G) \subset G^*$ and $uv \in E(A(G))$ if and only if $d_G(u, v) = \text{diam}(G)$.)

Examples 4.1.1. 1. *The trivial graph is the only graph having radius-forcing number equal to 1.*

2. *Any graph having radius 1 has radius-forcing number equal to 2.*

3. If $G \cong K_{m,n}$, $2 \leq m \leq n$, with partite sets V_1 and V_2 , then, for $S \subseteq V(G)$ such that $|S \cap V_i| \geq 2$ for $i \in \{1, 2\}$ we have $\text{rad}(S, G) = 2 = \text{rad}(G)$, whereas $\text{rad}(S, G) \leq 1$ if $|S \cap V_i| \leq 1$ for some $i \in \{1, 2\}$. So, $\rho(G) = 4$.
4. If G is a graph with $\text{rad}(G) = 1$, then $G^* \cong K_{p(G)}$. If G is a graph of radius 2, then $G^* = \overline{G}$. For $n \in \mathbb{N}$, $C_{2n}^* = nK_2$ ($n \geq 2$) and $C_{2n+1}^* = C_{2n+1}$.

Some preliminary results are listed in the following.

Proposition 4.1.2. *Let G be a connected graph and $\emptyset \neq S \subseteq V(G)$; then $\text{rad}(S, G) \leq \text{rad}(G)$.*

Proof. For any $v \in V(G)$, $e_G(v, S) = \max\{d_G(v, w); w \in S\} \leq e_G(v)$. So,

$$\begin{aligned} \text{rad}(S, G) &= \min\{e_G(v, S); v \in V(G)\} \\ &\leq \min\{e_G(v); v \in V(G)\} = \text{rad}(G). \end{aligned}$$

□

Proposition 4.1.3. *Let G be a connected graph and let $S \subseteq V(G)$ such that $\langle S \rangle_G$ is connected. Then,*

$$\text{rad}(S, G) \leq \text{rad}(\langle S \rangle_G).$$

Proof. If G and S satisfy the conditions above, then

$$\begin{aligned} \text{rad}(\langle S \rangle_G) &= \min\{e_{\langle S \rangle_G}(v); v \in S\} \\ &= \min\{\max\{d_{\langle S \rangle_G}(v, s); s \in S\}; v \in S\} \\ &\geq \min\{\max\{d_G(v, s); s \in S\}; v \in S\} \\ &\geq \min\{\max\{d_G(v, s); s \in S\}; v \in V(G)\} \\ &= \min\{e_G(v, S); v \in V(G)\} \\ &= \text{rad}(S, G). \end{aligned}$$

□

That there is a fundamental difference between $\text{rad}(S, G)$ and $\text{rad}(\langle S \rangle_G)$ is illustrated by the following proposition.

Proposition 4.1.4. *Given $n \in \mathbb{N}$, there exists a graph G and $S \subseteq V(G)$ for which $\text{rad}(\langle S \rangle_G) - \text{rad}(S, G) = n$.*

Proof. For $n \in \mathbf{N}$, let G_1 be any graph of radius $n + 1$, $G = K_1 + G_1$ and $S = V(G_1)$. Then, $\text{rad}(\langle S \rangle_G) = \text{rad}(G_1) = n + 1$ and $\text{rad}(S, G) = 1$, so that

$$\text{rad}(\langle S \rangle_G) - \text{rad}(S, G) = n.$$

□

Proposition 4.1.5. *Given $n, m \in \mathbf{N}$ with $n \geq 4$ and $m \leq \frac{n+2}{2}$, there exists a graph G and a set $S \subseteq V(G)$ such that $\text{rad}(S, G) = m$ and $\text{rad}(\langle S \rangle_G) = n$.*

Proof. Let $n, m \in \mathbf{N}$ with $n \geq 4$ and $m \leq \frac{n+2}{2}$. Let G be the graph obtained from $2n + 1$ disjoint copies of P_{m+1} by identifying one set of $2n + 1$ end-vertices of the $2n + 1$ paths to form a vertex v , and by linking up the set S of the remaining $2n + 1$ end-vertices of the $2n + 1$ paths in a path P_{2n+1} . Then, $\text{rad}(S, G) = e_G(v, S) = m$ and $\text{rad}(\langle S \rangle_G) = n$. □

Proposition 4.1.6. *For any connected graph G , connected subgraph H of G , and $\emptyset \neq S \subseteq V(H)$,*

$$\text{rad}(S, G) \leq \text{rad}(S, H).$$

Proof. Let G be a connected graph, let H be a connected subgraph of G and let $\emptyset \neq S \subseteq V(H)$. Certainly, for all $w \in V(H)$, $e_G(w, S) \leq e_H(w, S)$. So

$$\begin{aligned} \text{rad}(S, G) &= \min\{e_G(w, S); w \in V(G)\} \\ &\leq \min\{e_G(w, S); w \in V(H)\} \\ &\leq \min\{e_H(w, S); w \in V(H)\} \\ &= \text{rad}(S, H). \end{aligned}$$

□

Proposition 4.1.7. *If S is a radius-forcing set of a graph G , then any $T \subseteq V(G)$ with $S \subseteq T$ is also a radius-forcing set of G .*

Proof. Let G be a graph, $S \subseteq V(G)$ and $A = T - S$. Then, for any $v \in V(G)$,

$$\begin{aligned} e_G(v, T) &= \max\{d_G(v, w); w \in T\} \\ &= \max\{\max\{d_G(v, w); w \in S\}, \max\{d_G(v, w); w \in A\}\} \\ &= \max\{e_G(v, S), e_G(v, A)\} \\ &\geq e_G(v, S) \geq \text{rad}(G), \end{aligned}$$

and T is a radius-forcing set of G . □

4.2 The radius-forcing number of a graph

As we shall see in Section 4.3, the computation of $\rho(G)$ is an NP-complete problem. Hence, one cannot expect a simple characterization of graphs with given radius-forcing number. Graphs with radius-forcing number two, however, can easily be characterized.

Theorem 4.2.1. *For any connected, non-trivial graph G , $\rho(G) = 2$ if and only if $\text{diam}(G) \geq 2 \text{ rad}(G) - 1$.*

Proof. Let G be a non-trivial, connected graph. Suppose first that $\text{diam}(G) \geq 2 \text{ rad}(G) - 1$. Let $s_1, s_2 \in V(G)$ with $d_G(s_1, s_2) = \text{diam}(G)$. Then, for any $w \in V(G)$,

$$d_G(s_1, w) + d_G(s_2, w) \geq d_G(s_1, s_2) = \text{diam}(G) \geq 2 \text{ rad}(G) - 1,$$

so that at least one of $d_G(s_1, w), d_G(s_2, w)$ is at least $\text{rad}(G)$, and thus $\{s_1, s_2\}$ is a radius-forcing set of G , and $\rho(G) \leq 2$. Since G is connected and non-trivial, the desired result follows.

For the converse, let $S = \{s_1, s_2\}$ be a minimum radius-forcing set. Of course, for all $w \in V(G)$, $e_G(w, S) = \max\{d_G(w, s_1), d_G(w, s_2)\} \geq \text{rad}(G)$. Let $P : (s_1 =) x_0, x_1, \dots, x_m (= s_2)$ be a shortest $s_1 - s_2$ path. Then, for all $i \in \{0, 1, \dots, m\}$, $\max\{d_G(x_i, x_0), d_G(x_i, x_m)\} \geq \text{rad}(G)$; i.e., $\max\{i, m - i\} \geq \text{rad}(G)$ for all $i \in \{0, \dots, m\}$. So $\lceil \frac{m}{2} \rceil = \max\left\{\lceil \frac{m}{2} \rceil, m - \lceil \frac{m}{2} \rceil\right\} \geq \text{rad}(G)$, whence we obtain $\text{diam}(G) \geq m \geq 2 \text{ rad}(G) - 1$. \square

Corollary 4.2.2. *For every non-trivial tree T , $\rho(T) = 2$.*

Proposition 4.2.3. *Every non-trivial interval graph has radius-forcing number 2.*

Proof. Let G be an interval graph and let $[a(v), b(v)]$ be the interval corresponding to the vertex v . Let v', v'' be such that $b(v') = \min\{b(w) | w \in V(G)\}$ and $a(v'') = \max\{a(w) | w \in V(G)\}$. Then, for every vertex $v \in V(G)$, either v' or v'' is an eccentric vertex of v . Hence, $\{v', v''\}$ is a radius-forcing set of G . \square

Moreover, using Theorem 4.2.1, we can quickly calculate $\rho(P)$ for the Petersen graph P : $\text{rad}(P) = 2 = \text{diam}(P) = 2 \text{ rad}(P) - 2$ shows that $\rho(G) \geq 3$. If I is a maximum independent set of one of the 5-cycles C of P , then $V(C) - I$ is a radius-forcing set of P , whence $\rho(P) = 3$.

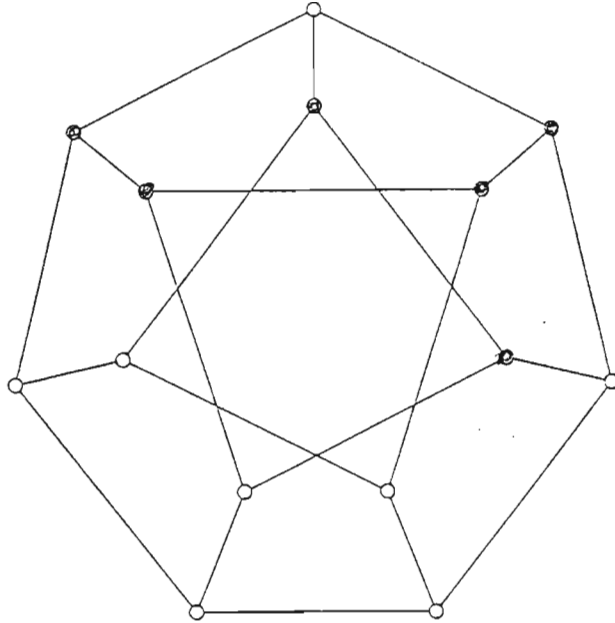

Figure 4.1: A generalized Petersen graph of order 14

Proposition 4.2.4. For the “generalized Petersen graph” GP_7 of order 14 shown in Figure 4.1, $\rho(GP_7) = 4$.

Proof. Since $\text{rad}(GP_7) = 3 = \text{diam}(GP_7) = 2 \text{ rad}(GP_7) - 3$, we have $\rho(GP_7) \geq 3$. We show, in fact, $\rho(GP_7) \geq 4$. Suppose, to the contrary, that there exists a radius-forcing set S of GP_7 of cardinality three. Since the graph GP_7 is 1-transitive, we may assume, without loss of generality, that exactly two of the vertices of S lie on the outer cycle of GP_7 (if the vertices of S all lie on one of the 7-cycle subgraphs of GP_7 , then $\text{rad}(S, G) \leq 2$). Say, $u \in S$. Let T be the set of all vertices at distance 2 or 1 from u (these vertices are bold in our diagram). Then, by our assumption about S , we must have $\{x, y\} \subseteq S$; however, then $e_{GP_7}(u, S) = 2 < \text{rad}(GP_7)$. So, $\rho(GP_7) \geq 4$. Since $\{x, y, r, s\}$ is a radius-forcing set of GP_7 , $\rho(GP_7) = 4$. \square

A characterization of graphs having radius-forcing number 3 appears to be difficult. It is true, however, that a graph with radius-forcing number 3 can have arbitrarily large radius r and maximum possible diameter $2r - 2$ (see Theorem 4.2.1); in fact, the diameter of a graph H with $\rho(H) = 3$ and radius r can be $2r - 2$ or arbitrarily smaller than $2r - 2$, as Proposition 4.2.5 shows. On the other hand, having diameter $2r - 2$ and radius r is not a sufficient condition for a graph to have radius-forcing number 3, as Proposition 4.2.6 shows. Furthermore, that having radius-forcing number 3 does not force a graph to have small girth is a consequence of Proposition 4.2.7,

which shows that arbitrarily large girths (of odd parity) are possible. (Of course, an indirect route to the investigation of the structure of graphs G having $\rho(G) = 3$ is to consider which graphs have total domination number 3; clearly, in any such graph, any minimum total dominating set will induce a path every vertex of which has degree 2 in the graph.)

Proposition 4.2.5. *Given any $a \in \mathbf{N}$, $a \geq 2$, there exists a graph G with $\rho(G) = 3$ and $\text{diam}(G) = 2 \text{rad}(G) - a$.*

Proof. Given $a \in \mathbf{N}$ with $a \geq 2$, let $b \in \mathbf{N}$ with $b \geq \frac{a}{2}$. Construct a graph G from the cycle $C_{3a} : v_0, v_1, \dots, v_{3a-1}, v_0$ and four additional vertices x, u, v , and w by joining the vertices u, v and w to v_0, v_a , and v_{2a} , respectively, with paths $P_{u,0}$, $P_{v,a}$, and $P_{w,2a}$, respectively, of length b , and by joining x to the vertices v_0, v_a, v_{2a} by paths $P_{x,0}$, $P_{x,a}$, and $P_{x,2a}$, respectively, of length a , so that $P_{u,0}, P_{v,a}, P_{w,2a}, P_{x,0}, P_{x,a}$, and $P_{x,2a}$ are mutually internally disjoint. Then, $\text{rad}(G) = a + b$ and $\text{diam}(G) = a + 2b = 2 \text{rad}(G) - a \leq 2 \text{rad}(G) - 2$, whence $\rho(G) \geq 3$. However, $\text{rad}(\{u, v, w\}, G) = \text{rad}(G)$; so, $\rho(G) = 3$. \square

Proposition 4.2.6. *There exists an infinite class of graphs G with $\text{diam}(G) = 2 \text{rad}(G) - 2$ and $\rho(G) > 3$.*

Proof. Let $r \in \mathbf{N}$ with $r \geq 3$ and let G be a graph obtained from the disjoint union of a $2r$ -cycle, $C : u_1, u_2, \dots, u_{2r}, u_1$, and a path of order $2r - 3$, $P : v_1, v_2, \dots, v_{2r-3}$, by identifying the vertices u_3 and v_{r-1} . We note that $e_G(u_i) = r$ for $i \in \{1, 2, 3, \dots, 5\}$ and that $e_G(w) > r$ for $w \in V(G) - \{u_1, u_2, \dots, u_5\}$; so $\text{rad}(G) = r$ and $\text{diam}(G) = r + (r - 2) = 2r - 2$. Furthermore, each of the vertices u_2, u_3, u_4 has a unique eccentric vertex in G , namely u_{2+r}, u_{3+r} and u_{4+r} , respectively. Hence, if S is a minimum radius-forcing set of G , then, as $e_G(u_i, S) \geq r$ for $i \in \{2, 3, 4\}$, it follows that $u_{2+r}, u_{3+r}, u_{4+r} \in S$; furthermore, as $e_G(u_{i+r}, S) \geq r \geq 3$ for $i \in \{2, 3, 4\}$, $S - \{u_{2+r}, u_{3+r}, u_{4+r}\}$ contains at least one vertex and so $\rho(G) = |S| \geq 4$. (More specifically, $\rho(G) = 4$ follows from the observation that $\{u_{r+2}, u_{r+3}, u_{r+4}, v_1\}$ is a radius-forcing set of G .) \square

Proposition 4.2.7. *For any $r \in \mathbf{N}$, $r \geq 3$, let G be obtained by $r - 1$ subdivisions of each spoke of the wheel with $2n$ outer vertices (so there are $r + 1$ vertices (in total) on each spoke), where $n = 2r - 3$ or $n = 2r - 4$. Then, $\text{rad}(G) = r$, $g(G) = 2r + 1$ and $\rho(G) = 3$.*

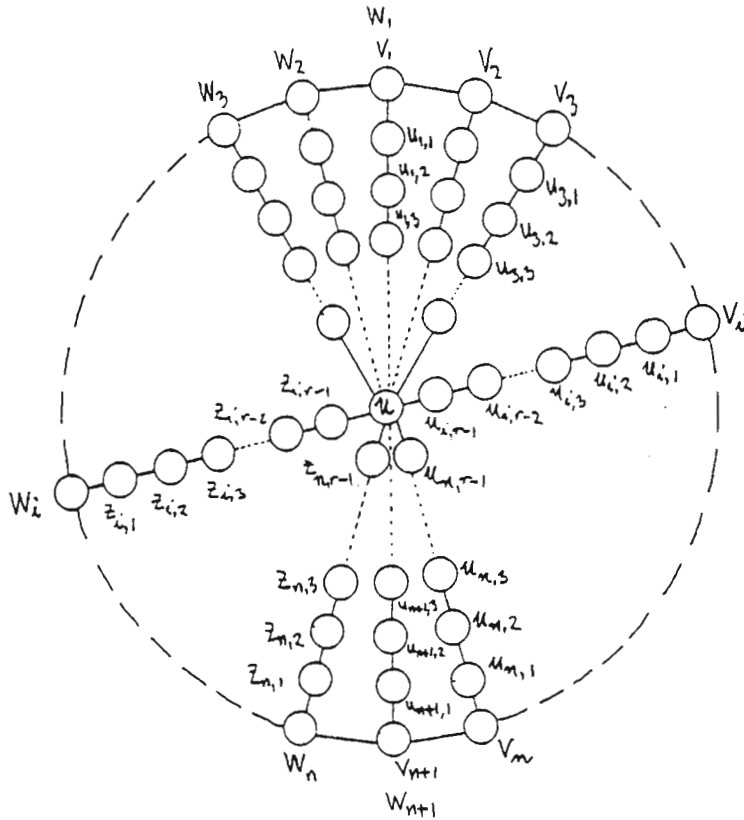

Figure 4.2: A graph with arbitrary odd girth and $\rho = 3$

Proof. Let $r, n \in \mathbb{N}$ and G be as defined above, where the vertices of G are labelled as in Figure 4.2. We see that v_1 is at distance at least r from all vertices in G except those in $S_1 \cup S_2$, where

$$S_1 = \{v_1, v_2, \dots, v_r, w_1, w_2, \dots, w_r\}$$

$$S_2 = \{z_{i,j}, u_{i,j}; 2 \leq i+j \leq r\}.$$

But u is at distance r from all vertices in S_1 and $u_{n+1,1}$ is at distance at least r from all vertices in S_2 . So, $\{v_1, u, u_{n+1,1}\}$ is a radius-forcing set whence $\rho(G) \leq 3$. Since $\text{diam}(G) = n \leq 2r - 3 = 2 \text{rad}(G) - 3$, Theorem 4.2.1 implies $\rho(G) \geq 3$. \square

In [Faj88], Fajtlowicz proved that a graph is r -critical if and only if it is an r -ciliate.

Proposition 4.2.8. *Let G be a radius-critical graph that is neither a path nor a cycle. Then, $G \cong C_{2a,r-a}$ for some $a, r \in \mathbb{N}$, $2 \leq a < r$ and $\rho(G) = 2a$.*

Proof. Let $a, r \in \mathbb{N}$ with $2 \leq a < r$ and let $G \cong C_{2a,r-a}$. It is easy to verify that, in every radius-forcing set of G , each vertex can be replaced by the closest end-vertex. Hence, there is a minimum radius-forcing set containing only end-vertices. On the other hand, no proper subset of the end-vertices is a radius-forcing set. \square

The next proposition presents an infinite class of self-centred graphs G for which $\rho(G) \geq 4$ can be arbitrarily large (and even).

Proposition 4.2.9. *Let $n \in \mathbf{N}$. Then, $\rho(K_2 \times C_{2n+1}) = 2n + 2$.*

Proof. Let $n \in \mathbf{N}$ and let $G \cong K_2 \times C_{2n+1}$. Notice that G is self-centred and that $G^* \cong C_{4n+4}$. Since $\gamma_t(C_{2n+4}) = 2n + 2$, the desired result follows. \square

Having considered graphs of minimum possible radius-forcing number, we now turn to the graphs having maximum possible radius-forcing number.

Theorem 4.2.10. *A graph G satisfies $\rho(G) = p(G)$ if and only if G is a self-centred unique eccentric vertex graph.*

Proof. Let G be a graph with $\rho(G) = p = p(G)$. Since any connected graph F of order at least 3 satisfies $\gamma_t(F) \leq p(F) - 1$, it follows that each component of G^* has at most two vertices and thus $G^* \cong nK_1 \cup mK_2$ for some non-negative integers m, n . But G^* has no isolated vertex. So, $G^* \cong \frac{p}{2}K_2$ and, for every vertex $v \in V(G)$, there is only one vertex G at distance at least $\text{rad}(G)$ from v . Hence, every vertex has a unique eccentric vertex and G is self-centred.

Conversely, suppose G is a self-centred, unique eccentric vertex graph. Then, for any vertex v of G , there is exactly one vertex v^* that is at distance at least $\text{rad}(G)$ from v . So, in G^* , every vertex has degree 1. So, $G^* = mK_2$ for some $m \in \mathbf{N}$ and $\rho(G) = \gamma_t(G^*) = p(G)$, as required. \square

Now, considering the statement of Theorem 4.2.1 that a graph G has $\rho(G) = 2$ if and only if $\text{diam}(G) \geq 2 \text{rad}(G) - 1$, and the statement of Theorem 4.2.10, one may be inclined to believe that, relative to its order, a graph's radius-forcing number is large if the diameter is "close" to the radius. However, for $k, n \in \mathbf{N}$ ($n \geq 2$), the graph F which is the lexicographic product $C_{2n}[K_k]$ of C_{2n} and K_k is such that $\rho(F) = \rho(C_{2n}) = 2n$ and $p(F) = 2kn$, i.e., $\frac{\rho(F)}{p(F)} = \frac{1}{k}$, while $\text{diam}(F) = n = \text{rad}(F)$.

That the simple operation of subdivision of an edge can have the effect of almost halving the radius-forcing number of a graph is illustrated by Proposition 4.2.11. That the contraction of an edge can produce a graph with a radius-forcing number that is an arbitrarily large factor smaller than the the radius-forcing number of the original graph is seen as follows: If $n \geq 2$ is an integer, $G \cong K_{2n}$, F is a perfect

matching of G , $H = G - F$, and $V(H) = A \cup B$ such that $\langle A \rangle_H \cong \langle B \rangle_H \cong K_n$, then the contraction of any edge e of $\langle A \rangle_H$ or $\langle B \rangle_H$ yields a graph G' having $\rho(G') = 2$, while H , being a self-centred, unique eccentric vertex graph, satisfies $\rho(H) = 2n$.

Proposition 4.2.11. *Let $n \in \mathbf{N}$. Then*

$$\begin{aligned}\rho(C_{2n+1}) &= n + 1 \\ \rho(C_{2n}) &= 2n, \quad n \geq 2.\end{aligned}$$

Proof. Let $n \in \mathbf{N}$. For $n \geq 2$, that $\rho(C_{2n}) = 2n$ follows immediately from Theorem 4.2.10. Since C_{2n+1} is self-centred and $C_{2n+1}^* \cong C_{2n+1}$ and $\gamma_t(C_{2n+1}) = n + 1$, $\rho(C_{2n+1}) = n + 1$. \square

The next theorem provides a description of all connected graphs having $\rho(G) = p(G) - 1$. First, we present two lemmas.

Lemma 4.2.12. *If G is a connected graph with $p(G) \geq 4$, then $\gamma_t(G) \leq p(G) - 2$.*

Lemma 4.2.13. *Let G be a connected graph of radius $r \geq 2$ and order p with $\rho(G) = p - 1$. Then p is odd and $V(G) = \{u, v, w\} \cup \{x_{1i}, x_{2i}; \quad i = 1, 2, \dots, \frac{p-3}{2}\}$, where*

- (i) $d_G(u, v) = d_G(u, w) = r$, $d_G(v, w) \leq r$,
- (ii) $d_G(y, x_{ji}) < r$ for $y \in \{u, v, w\}$, $j \in \{1, 2\}$, $i \in \{1, 2, \dots, \frac{p-3}{2}\}$,
- (iii) $d_G(x_{1i}, x_{2i}) = r$, $i = 1, 2, \dots, \frac{p-3}{2}$.

Proof. Let G be a graph of order p having $\rho(G) = p - 1$. Then, no component of G^* has order more than three (by Lemma 4.2.12). Furthermore, at most one component of G^* has order three since any connected graph of order three has total domination number two. So, $G^* = \frac{p}{2}K_2$ or $G^* \cong \frac{p-3}{2}K_2 \cup P_3$ or $G^* \cong \frac{p-3}{2}K_2 \cup K_3$. However, $\gamma_t(\frac{p}{2}K_2) = p \neq \rho(G)$, and the desired result follows. \square

Theorem 4.2.14. *Let G be a connected graph of order p with $\rho(G) = p(G) - 1$.*

- (1) *If $\text{rad}(G) = 1$, then $G \cong K_3$ or $G \cong K_{1,2}$.*
- (2) *If $\text{rad}(G) = 2$, then, for H the complete $\frac{p-1}{2}$ -partite graph $K(3, 2, 2, \dots, 2)$, we have $G \cong H$ or $G \cong H + e$ where $e \in E(\bar{H})$ joins two vertices in the partite set of cardinality 3.*

(3) If $\text{rad}(G) \geq 3$, then $V(G) = \{u, v, w\} \cup \{x_{1i}, x_{2i}; i = 1, 2, \dots, \frac{p-3}{2}\}$ where

(i) $d_G(u, v) = d_G(u, w) = r$, $d_G(v, w) \leq r$,

(ii) $d_G(y, x_{ji}) < r$ for $y \in \{u, v, w\}$, $j \in \{1, 2\}$, $i \in \{1, 2, \dots, \frac{p-3}{2}\}$,

(iii) $d_G(x_{1i}, x_{2i}) = r$, $i \in \{1, 2, \dots, \frac{p-3}{2}\}$.

Proof. Since $\rho(H) = 2$ for any graph H having radius 1, (1) follows immediately. Statement (3) holds by Lemma 4.2.13. Let G be a connected graph of radius two. By Lemma 4.2.13, $V(G) = \{u, v, w\} \cup \{x_{1i}, x_{2i}; 1 \leq i \leq \frac{p-3}{2}\}$ where $d_G(u, v) = d_G(u, w) = 2$, $d_G(v, w) \in \{1, 2\}$, each of u, v and w is adjacent to every vertex of $V(G) - \{u, v, w\}$ and, for each i , $1 \leq i \leq \frac{p-3}{2}$, x_{1i} (respectively, x_{2i}) is adjacent to each vertex of $V(G) - \{x_{2i}\}$ (respectively, $V(G) - x_{1i}$). Clearly, (2) holds. \square

We conclude this section with four bounds on ρ . Based on the observation that $\rho(G) = \gamma_t(G^*) \leq \frac{2}{3}p(G^*)$ (see [CDH80]) for any connected graph of order at least three, it follows that $\rho(G) \leq \frac{2}{3}p(G)$ whenever G is a connected graph of order at least three, having no vertex with a unique eccentric vertex. Three lower bounds are given next.

Proposition 4.2.15. *For a connected graph G of order p , finite radius $r \geq 2$, minimum degree δ , and connectivity κ ,*

1. $\rho(G) \geq \left\lceil \frac{p}{p-1-(r-1)\kappa} \right\rceil$

2. $\rho(G) \geq \begin{cases} \left\lceil \frac{p}{p-[\delta-2]\lfloor \frac{r-1}{3} \rfloor - r} \right\rceil & \text{if } r \geq 4, \\ \left\lceil \frac{p}{p-\delta-2} \right\rceil & \text{if } r = 3, \\ \left\lceil \frac{p}{p-\delta-1} \right\rceil & \text{if } r = 2. \end{cases}$

3. $\rho(G) \geq \left\lceil \frac{p}{t} \right\rceil$ where $t = \max\{|\{y \in V(G); d_G(y, v) \geq r\}|; v \in V(G)\}$.

Proof. Let G , p , r , δ and κ be as described above. Let $v \in V(G)$ and $A_i = \{y \in V(G); d_G(y, v) = i\}$ for i , $1 \leq i \leq e_G(v)$. Clearly, $N_{G^*}(v) = \bigcup_{i=r}^{e_G(v)} A_i$ so that $\deg_{G^*} v = p - 1 - \sum_{i=1}^{r-1} |A_i|$. Observing that $|A_i| \geq \kappa$ for $1 \leq i \leq r - 1$, we have $\Delta(G^*) \leq p - 1 - (r - 1)\kappa$ and so

$$\rho(G) = \gamma_t(G^*) \geq \left\lceil \frac{p}{\Delta(G^*)} \right\rceil \geq \left\lceil \frac{p}{p - 1 - (r - 1)\kappa} \right\rceil.$$

Moreover, observing that, for any j , $2 \leq j \leq r-2$, $|A_{j-1} \cup A_j \cup A_{j+1}| \geq \delta+1$, we have, for $r \geq 4$, that $\Delta(G^*) \leq p-1 - \{\lfloor \frac{r-1}{3} \rfloor (\delta+1) + r-1 - 3 \lfloor \frac{r-1}{3} \rfloor\} = p - (\delta-2) \lfloor \frac{r-1}{3} \rfloor - r$, whence

$$\rho(G) \geq \left\lceil \frac{p}{p - (\delta-2) \lfloor \frac{r-1}{3} \rfloor - r} \right\rceil.$$

For $r = 3$, $\Delta(G^*) \leq p-1 - (\delta+1) = p - \delta - 2$ so that $\rho(G) \geq \left\lceil \frac{p}{p-\delta-2} \right\rceil$; and for $r = 2$, $\Delta(G^*) \leq p-1 - \delta$ so that $\rho(G) \geq \left\lceil \frac{p}{p-\delta-1} \right\rceil$. Result 3 follows from the fact that $\Delta(G^*) = \max\{|A_v|; v \in V(G)\}$, where $A_v = \{y \in V(G); d_G(y, v) \geq r\}$ and $\rho(G) \geq \left\lceil \frac{p(G)}{\Delta(G^*)} \right\rceil$. \square

Consideration of the even cycles shows that the first bound in Proposition 4.2.15 is sharp. To show that the next three are also sharp, let k and δ be positive integers with $\delta \geq 2$, and consider the graph G obtained from a path $P : v_1, v_2, \dots, v_{6k}$ by the replacement of each of the vertices v_{2+3i} ($0 \leq i \leq 2k-1$) by a graph $G_{2+3i} \cong K_{\delta-1}$, the deletion of the edges $v_{1+3i}v_{2+3i}$ and $v_{2+3i}v_{3+3i}$, the addition of the edges av_{1+3i} , av_{2+3i} for all $a \in V(G_{2+3i})$, the addition of two new vertices u and v , where u is joined to v_1 and to every vertex of $V(G_2)$, and where v is joined to v_{6k} and to every vertex of $V(G_{6k-1})$. Then, $\text{rad}(G) = 3k$, $\text{diam}(G) = 6k-1$ (whence $\rho(G) = 2$), $\delta(G) = \delta$, and $p(G) = 2k\delta + 2k + 2$. If $k \geq 2$ (so that $\text{rad}(G) > 3$), then Proposition 4.2.15 gives $\rho(G) \geq \left\lceil \frac{p}{p - [\delta-2] \lfloor \frac{r-1}{3} \rfloor - r} \right\rceil = \left\lceil \frac{2\delta+2+\frac{2}{k}}{\delta+1+\frac{2}{k}} \right\rceil$, where $\left\lceil \frac{2\delta+2+\frac{2}{k}}{\delta+1+\frac{2}{k}} \right\rceil \rightarrow 2$ as $k \rightarrow \infty$. If $k = 1$ (so that $\text{rad}(G) = 3$), Proposition 4.2.15 gives $\rho(G) \geq \left\lceil \frac{p}{p-\delta-2} \right\rceil = 2$. Finally, if H is the graph obtained from G by the deletion of the set $\{v_4\} \cup V(G_5) \cup \{v_6\} \cup \dots \cup V(G_{6k-4}) \cup \{v_{6k-3}\}$ of vertices and the identification of the vertices v_3 and v_{6k-2} , then $\text{rad}(H) = 2$, $\text{diam}(G) = 4$, $\rho(H) = 2$, $\delta(H) = \delta$ and $p(H) = 2\delta + 3$, and Proposition 4.2.15 gives $\rho(G) \geq \left\lceil \frac{p}{p-\delta-1} \right\rceil = \left\lceil \frac{2\delta+3}{p-\delta-1} \right\rceil = 2$.

4.3 NP-Completeness considerations

It would be very interesting to characterize the class of graphs G^* (for a connected graph G) since, if this class is “large enough,” the decision problem RF (see below) associated with $\rho(G)$ would perhaps be NP-complete (since determining $\rho(G)$ is essentially determining $\gamma_t(G^*)$ and the total domination problem is NP-complete ([KM86])). Unfortunately, the problem of characterizing the graphs G^* seems to be very difficult, since it is related to the problem of characterizing powers of graphs (see Section 4.1). Fortunately, that the problem of total domination for bipartite graphs is NP-complete is sufficient to show the NP-completeness of RF.

Definition 4.3.1. We define the Radius-Forcing Number Problem RF as follows:

INSTANCE: A connected graph G , integer $M \geq 1$.

QUESTION: Is $\rho(G) \leq M$?

Theorem 4.3.1. *RF is NP-complete.*

Proof. That RF is in NP follows from the fact that it can be efficiently verified whether a given set of vertices of a connected graph is a radius-forcing set of the graph.

The problem of computing the total domination number for bipartite graphs is NP-complete ([PLH83]). We shall show that RF is NP-complete by showing that BTM is reducible in polynomial time to RF, where BTM shall refer to the problem “Given a non-complete bipartite graph B (without isolated vertices) and a positive integer M , is the total domination number $\gamma_t(B) \leq M$?”

Let B be any non-complete bipartite graph without isolated vertices with partite sets V_1 and V_2 , and let M be a positive integer. Let $G = \overline{B}$ (we can construct G in polynomial time). Notice that, since B is non-complete, G is connected and has radius 2. Hence, by definition of the graph G^* , $B = G^*$ and thus $\gamma_t(B) = \rho(G)$. \square

With the next two results, we show that, for graphs G having radius two and domination number two, we have $\theta(G) = \rho(G) = \gamma_t(\overline{G})$, whence it follows that there is a set of graphs H having radius two and domination number two for which the decision problem associated with determining $\theta(H)$ is NP-hard. Whether the problem of determining $\theta(H)$ for all graphs is in NP is not known. Indeed, given a set $S \subseteq V(G)$, there seems to be no obvious polynomial algorithm to verify that S is a domination-forcing set, since this involves calculating $\gamma(S, G)$ and $\gamma(G)$.

Definition 4.3.2. We define the decision problem THETAP as follows:

INSTANCE: A connected graph G , integer $M \geq 1$.

QUESTION: Is $\theta(G) \leq M$?

Lemma 4.3.2. *If G is a graph for which $\gamma(G) = \text{rad}(G) = 2$, then*

$$\theta(G) = \rho(G) = \gamma_t(\bar{G}).$$

Proof. Observe that, for a graph G with $\gamma(G) = \text{rad}(G) = 2$, we have that $S \subseteq V(G)$ is a radius-forcing set of G if and only if S is a domination-forcing set of G . \square

Theorem 4.3.3. *For the set of all graphs H having $\text{rad}(H) = \gamma(H) = 2$, the decision problem associated with determining $\theta(H)$ is NP-complete.*

Proof. Recall that the decision problem BTM (defined in the proof of Theorem 4.3.1 above), namely, the decision problem associated with determining the total domination number of a bipartite graph, is NP-complete.

For graphs G with $\gamma(G) = 2$, the problem THETAP is in NP since, given a set $S \subseteq V(G)$, it is possible to check in polynomial time whether $\gamma(S, G) = 2$ (i.e., the intersection of the closed neighbourhoods of all the vertices of S is empty) or $\gamma(S, G) = 1$.

We show now that THETAP is NP-hard. Let G be a non-complete bipartite graph with no isolated vertices, let $M \in \mathbf{N}$ and let $H = \bar{G}$ (as we mentioned before, the complement of a graph can be constructed in polynomial time). Then, $\text{rad}(H) = \gamma(H) = 2$ and $\gamma_t(\bar{H}) = k \leq M$ if and only if $\theta(H) = k \leq M$, i.e., $\gamma_t(G) = k \leq M$ if and only if $\theta(H) = k \leq M$. So, the problem of determining $\theta(H)$ for those graphs H that are the complement of a non-complete bipartite graph G with no isolated vertices is NP-hard and thus NP-complete. \square

4.4 Randomly k -forcing graphs

We refer the reader to the motivation provided in Section 4.1 where we discussed the selection of a smallest set of facilities at which to store material to ensure the survival of that material in the event of a disaster occurring at any one of the facilities. Imagine now the situation where the time and cost of finding such a set is sufficiently high to warrant re-evaluation by management of this method of ensuring security (after all, RF is NP-complete). In other words, suppose that there are other factors more important than the size of our security-ensuring collection of facilities. The question is, does there exist a number k such that *every* subset of $V(G)$ of size k is a radius-forcing set (where G is, again, the graph that models our system of facilities).

If such a number k exists, and is not too much bigger than $\rho(G)$, then those other factors can be allowed to determine where our material is stored. Clearly, picking the smallest such k is the most cost-effective. A formal definition is as follows.

Definition 4.4.1. We call a connected graph G a *randomly k -forcing graph* ($k \in \mathbf{N}$) if $\text{rad}(S, G) = \text{rad}(G)$ for every $S \subseteq V(G)$, $|S| = k$ (i.e., every k -set of $V(G)$ is a radius-forcing set of G).

Notice that every connected graph G is a randomly $p(G)$ -forcing graph, which justifies the following definition.

Definition 4.4.2. For a connected graph G , let $\text{rf}(G)$, the *randomly forcing number* of G , denote the smallest k for which G is a randomly k -forcing graph.

Observation. 1. For all connected graphs G , $\rho(G) \leq \text{rf}(G) \leq p(G)$.

2. For all connected graphs G and $\ell \in \mathbf{N}$, $\text{rf}(G) \leq \ell \leq p(G)$, G is randomly ℓ -forcing.

3. For a connected graph G ,

$$\text{rf}(G) = 1 + \max\{\ell \in \mathbf{N}; \exists T \subseteq V(G), |T| = \ell, \text{rad}(T, G) < \text{rad}(G)\}.$$

Proposition 4.4.1. For any connected subgraph H of G satisfying $\text{rad}(H) < \text{rad}(G)$, $\text{rf}(G) > p(H)$.

Proof. For G and H satisfying the hypothesis of the proposition and $S \subseteq V(H)$,

$$\text{rad}(S, G) \leq \text{rad}(S, H) \leq \text{rad}(H) < \text{rad}(G).$$

So, $\text{rf}(G) > \max\{|S|; S \subseteq V(H)\} = p(H)$. □

Corollary 4.4.2. For a connected graph G of order p , radius $r \in \mathbf{N}$ and maximum degree Δ ,

$$\text{rf}(G) \geq p - \Delta(\Delta - 1)^{r-1} + 1.$$

Proof. Let G be a connected graph of order p , finite radius r and maximum degree Δ . Construct a breadth first search tree T rooted at any central vertex c of G , and

let L be the leaves of T that are the eccentric vertices of c . Then, $\text{rad}(G - L) = r - 1$. So, by Proposition 4.4.1,

$$\text{rf}(G) > p - |L| \geq p - \Delta(\Delta - 1)^{r-1}$$

□

The bound given by the above proposition is best possible since it is attained by any Δ -ary tree.

In [PES86], Erdős, Saks and Sós proved that every connected graph of radius r contains a path P_{2r-1} as an induced subgraph, whence the following.

Corollary 4.4.3. *If G is a connected graph, then $\text{rf}(G) \geq 2\text{rad}(G)$.*

Examples 4.4.4. 1. For $n \in \mathbb{N}$, $\text{rad}(P_{2n-1}) < \text{rad}(C_{2n+1}) = n$, so that $\text{rf}(C_{2n+1}) \geq 2n$; obviously, $\text{rf}(C_{2n+1}) = 2n$. Since $\rho(C_{2n}) = 2n$, $\text{rf}(C_{2n}) = 2n$ follows trivially.

2. Any graph G of radius 1 has $\text{rf}(G) = 2$.

3. If v is an end-vertex of an r -ciliate $C_{2a,r-a}$ ($2 \leq a < r$), then $\text{rad}(C_{2a,r-a} - v) < \text{rad}(C_{2a,r-a})$, so that $\text{rf}(C_{2a,r-a}) > p(C_{2a,r-a} - v)$ and it follows that $\text{rf}(C_{2a,r-a}) = p(C_{2a,r-a})$.

4. For $n \in \mathbb{N}$, $\text{rad}(P_{2n-1}) = n - 1 < n = \text{rad}(P_{2n})$, so that $\text{rf}(P_{2n}) > 2n - 1$, and $\text{rf}(P_{2n}) = p(P_{2n})$ follows. Furthermore, $\text{rad}(P_{2n}) = n = \text{rad}(P_{2n+1})$, while $\text{rad}(P_{2n-1}) = n - 1 < \text{rad}(P_{2n+1})$, whence $\text{rf}(P_{2n+1}) \geq 2n$. However, it is easy to see that any $2n$ -set of $V(G)$ is a radius-forcing set of P_{2n+1} . So, $\text{rf}(P_{2n+1}) = p(P_{2n+1}) - 1$.

Obviously, a graph G being randomly $\text{rf}(G)$ -forcing does not imply $\rho(G) = \text{rf}(G)$, which leads naturally to the problem of determining which graphs G do satisfy $\rho(G) = \text{rf}(G)$.

Proposition 4.4.5. *A connected graph G is a randomly a -forcing graph of order p with $a = \rho(G)$ if and only if $a = p$ or $a = 2 < p$ and $\text{rad}(G) = 1$.*

Proof. Let G be a connected graph of order p . If $\rho(G) = p$, then obviously G is randomly $\rho(G)$ -forcing. Otherwise, if $\text{rad}(G) = 1$, then $\rho(G) = 2$ and every pair of

distinct vertices of G form a radius-forcing set, so that G is randomly $\rho(G)$ -forcing. Conversely, suppose that G is randomly a -forcing graph with $a = \rho(G)$. Suppose $a < p$. Then, every a -set of $V(G^*)$ is a minimum total dominating set of G^* . Let D be a minimum total dominating set of G^* ; let $J = \langle D \rangle_{G^*}$. Suppose J contains a path of length greater than one; let $P : x_1, x_2, \dots, x_k$ ($k \geq 3$) be a longest path in J . Then, $N_J(x_1) \subseteq V(P)$ and x_1 has no private neighbour in $V(P)$, so that x_1 must have a private neighbour y (say) in $V(G^*) - D$. Then, $D' = (D - \{x_1\}) \cup \{y\}$ is not a total dominating set (since y has no neighbour in D'); however, this contradicts the fact that $|D'| = a$. Hence, J contains precisely paths of length one. So, $\langle A \rangle_{G^*} \cong \frac{a}{2}K_2$ for every a -set A in $V(G^*)$.

Case 1: Suppose $a \geq 3$ (and hence $p \geq 4$) and G^* is connected. Then, if u, v, w is a path of length 2 in G^* , the set $\{u, v, w\}$ can be extended to an a -set A' of G^* , where $\delta(\langle A' \rangle_{G^*}) \geq 2$, which is impossible.

Case 2: Suppose $a \geq 3$ and G^* is disconnected. Then, by an argument similar to that used in Case 1, it follows that every component of G^* is a copy of K_2 . However, since $a < p$, there exists an a -set A'' in $V(G^*)$ that contains a single vertex of some component of G^* , so that $\delta(\langle A'' \rangle_{G^*}) = 0$, which is impossible.

Case 3: Suppose $a = 2$ (and hence $p \geq 3$). Then, every two vertices of G^* are joined by an edge, so that G^* is complete. Therefore, $\text{rad}(G) = 1$. □

4.5 The effect on $\rho(G)$ of adding an edge

In the following few propositions, we consider the effect on the radius and radius-forcing number of a graph G of the addition of an edge $e \in E(\bar{G})$. Specifically, we show that there are graphs G and $e \in E(\bar{G})$ where (i) $\text{rad}(G + e) = \text{rad}(G)$ and $\rho(G + e) = \rho(G)$, (ii) $0 < \text{rad}(G) - \text{rad}(G + e)$ can be prescribed, and $\rho(G + e) = \rho(G)$, (iii) $\text{rad}(G + e) = \text{rad}(G)$ and $0 < \rho(G + e) - \rho(G)$ can be prescribed, (iv) $0 < \text{rad}(G) - \text{rad}(G + e)$ and $0 < \rho(G + e) - \rho(G)$ can both be prescribed, or (v) $0 < \text{rad}(G) - \text{rad}(G + e)$ and $0 < \rho(G) - \rho(G + e)$ can both be prescribed.

If we add an edge e to a connected graph G such that $\text{rad}(G) = \text{rad}(G + e)$, then every radius-forcing set of $G + e$ is also a radius-forcing set of G . Hence, we have the following.

Proposition 4.5.1. *For any non-complete, connected graph G and $e \in E(\bar{G})$ for which $\text{rad}(G + e) = \text{rad}(G)$,*

$$\rho(G + e) \geq \rho(G).$$

That the ratio $\frac{\rho(G+e)}{\rho(G)}$ can be arbitrarily large or arbitrarily small for a connected graph G and $e \in E(\bar{G})$ is shown by the following.

Proposition 4.5.2. *For any $n \in \mathbf{N}$,*

- (1) *there exists a graph G and $e \in E(\bar{G})$ with $\text{rad}(G) = \text{rad}(G + e)$ and $\frac{\rho(G+e)}{\rho(G)} = n$;*
- (2) *there exists a graph H and $f \in E(\bar{H})$ with $\text{rad}(H) = 2 \text{rad}(H + f)$ and $\frac{\rho(H+f)}{\rho(H)} = \frac{1}{2n}$.*

Proof. Let $n \in \mathbf{N}$. If $G \cong P_{4n-1}$ and $e \in E(\bar{G})$ joins the end-vertices of G , then $\text{rad}(G + e) = \text{rad}(C_{4n-1}) = 2n - 1 = \text{rad}(G)$ and $\frac{\rho(G+e)}{\rho(G)} = \frac{2n}{2} = n$. If $H \cong C_{4n}$ and $f \in E(\bar{H})$ joins the end-vertices of any diametral path in H , then $\text{rad}(H + f) = n = \frac{1}{2} \text{rad}(H)$ and $\frac{\rho(H+f)}{\rho(H)} = \frac{1}{2n}$. \square

Proposition 4.5.2 shows, moreover, that we can simultaneously prescribe $\text{rad}(H + f) - \text{rad}(H)$ and $\rho(H) - \rho(H + f)$. That it is possible to prescribe the differences $\text{rad}(G) - \text{rad}(G + e)$ and $\rho(G + e) - \rho(G)$ for a connected graph G and $e \in E(\bar{G})$ is shown by the following.

Proposition 4.5.3. *For any $n, t \in \mathbf{N}$ with $2 \leq n \leq t - 1$, there exists a connected graph G and $e \in E(\bar{G})$ such that $\text{rad}(G) - \text{rad}(G + e) = n$ and $\rho(G + e) - \rho(G) = t - 1$.*

Proof. Let $n, t \in \mathbf{N}$ with $2 \leq n \leq t - 1$ and let G be the graph obtained from two $2n$ -cycles C_1 and C_2 and a path P_{2t+1} with end-vertices x_1 and x_2 by identifying x_i with a single vertex of C_i ($i = 1, 2$). Then, for $e = x_1x_2$,

$$\text{rad}(G) - \text{rad}(G + e) = n + t - t = n$$

and

$$\rho(G + e) - \rho(G) = t + 1 - 2 = t - 1$$

\square

That $\text{rad}(G)$ and $\text{rad}(G + e)$ can differ for a connected graph G and $e \in E(\bar{G})$ without $\rho(G)$ and $\rho(G + e)$ differing is shown below.

Proposition 4.5.4. *For any $a \in \mathbf{N}$, $a \geq 2$, there exists a graph G with $\text{rad}(G) - \text{rad}(G + e) = a$ and $\rho(G + e) = \rho(G)$.*

Proof. Let $a \in \mathbf{N}$, $a \geq 2$, and let $G \cong P_{4a} : v_0, v_1, \dots, v_{4a-1}$. Then,

$$\text{rad}(G) - \text{rad}(G + v_a v_{3a}) = 2a - a = a$$

and

$$\rho(G) = \rho(G + v_a v_{3a}) = 2$$

(since $\text{diam}(G + v_a v_{3a}) \geq 2 \text{rad}(G + v_a v_{3a}) - 1$ and $\text{diam}(G) \geq 2 \text{rad}(G) - 1$). \square

Finally, an infinite class of graphs G for which there exists $e \in E(\bar{G})$ such that $\text{rad}(G) = \text{rad}(G + e)$ and $\rho(G) = \rho(G + e)$ is the class of r -ciliates:

Proposition 4.5.5. *For any $a, r \in \mathbf{N}$ with $2 \leq a \leq r - 1$, there exists a connected graph G and $e \in E(\bar{G})$ such that $\text{rad}(G) = \text{rad}(G + e) = r$ and $\rho(G + e) = \rho(G) = 2a$.*

Proof. Let $G \cong C_{2a, r-a}$ for $a, r \in \mathbf{N}$ with $2 \leq a \leq r - 1$ and let $e \in E(\bar{G})$ such the e joins two closest end-vertices of G . \square

4.6 k -Radius-forcing sets

Recall that, in Section 4.1, we saw that the radius-forcing number $\rho(G)$ for a connected graph G of order p is the size of a smallest set S of vertices of G such that, for each vertex $v \in V(G)$, there exists $s \in S$ such that $d_G(v, s) \geq \text{rad}(G)$. This definition may be motivated by our example of a network N of p facilities in which essential data or materials are storeable, where N had the property that, if a disaster or failure of some kind occurs at a facility (represented by a vertex v , say), then all facilities represented by vertices at distance at most $\text{rad}(G) - 1$ from v will be jeopardized, and, further, there was the requirement of selecting a smallest collection of facilities on which to spend the funds necessary in order to store the essential data (or materials) with the purpose that our material or information is retrievable from somewhere in the system even in the case when an arbitrary facility fails. We can generalize this situation further with the assumption that, given our constructed network, circumstances (or the nature of the facilities or the nature of the material to be stored) changes, so that, for some $k \in \{1, 2, \dots, \text{rad}(G)\}$, only those facilities represented by vertices within distance $k - 1$ from any given vertex v are in danger should failure occur at the facility represented by v . As we shall show, a smaller

collection of storing facilities need be selected (and hence less financial outlay is required) when conditions are relaxed in this way. In this section and the next, we investigate the value of the parameters ρ_k for general graphs, as well as for specific classes of graphs.

It is simple to see that $\rho_0(G) = 1$, $\rho_1(G) = 2$ and $\rho_i(G) \geq 2$ for $2 \leq i \leq \text{rad}(G)$ for any connected graph G . In fact, it follows immediately from the definition that, for any connected graph G , we must have $\rho_0(G) \leq \rho_1(G) \leq \rho_2(G) \leq \dots \leq \rho_{\text{rad}(G)}(G)$. So, for example, we have

Example 4.6.1. *For any non-trivial tree T , $\rho(T) = 2$ (see Theorem 4.2.1), it follows that $\rho_1(T) = \rho_2(T) = \dots = \rho_{\text{rad}(G)}(T) = 2$.*

The radius of a set S in a connected graph G is related to a distance-domination number of S in G in the following way. (Recall (see Definition 3.3.1) that the n -distance-domination number $\gamma_n(S, G)$ of $S \subseteq V(G)$ is the size of a smallest set $D \subseteq V(G)$ such that every vertex of S is n -distance-dominated by some vertex in D .)

Proposition 4.6.2. *Let G be a connected graph and $\emptyset \neq S \subseteq V(G)$. Then, $\text{rad}(S, G)$ is the smallest k with $\gamma_k(S, G) = 1$.*

Proof. Let G be a connected graph and $\emptyset \neq S \subseteq V(G)$. Suppose first that k is the smallest integer ℓ for which $\gamma_\ell(S, G) = 1$. Then, there exists a vertex $w_0 \in V(G)$ such that every vertex of S is within distance k of w_0 . So, $\text{rad}(S, G) \leq e_G(w_0, S) = \max\{d_G(w_0, s); s \in S\} \leq k$. Suppose $\text{rad}(S, G) = \ell < k$ for some $\ell \in \{0, 1, \dots, k-1\}$. Then, there exists a vertex $y_0 \in V(G)$ such that $\ell = e_G(y_0, S) = \max\{d_G(y_0, s); s \in S\}$, i.e., every vertex of S is within distance ℓ of y_0 . So $\gamma_\ell(S, G) = 1$. However, this contradicts our choice of k . So, $\text{rad}(S, G) \geq k$, and the desired result follows.

Conversely, if $\text{rad}(S, G) = k$, then there exists $v_0 \in V(G)$ with $e_G(v_0, S) = \max\{d_G(v_0, s); s \in S\} = k$, i.e., $\{v_0\}$ k -distance-dominates S . Furthermore, by what we proved above, k is the *smallest* such integer. \square

We give next a characterization of those connected graphs G and integers k , $0 \leq k \leq \text{rad}(G)$, for which $\rho_k(G) = 2$. This theorem generalizes Theorem 4.2.1.

Theorem 4.6.3. *For any connected graph G and $k \in \mathbf{N}$, $k \geq 2$,*

$$\rho_k(G) = 2 \text{ if and only if } \text{diam}(G) \geq 2k - 1.$$

Proof. Let G be a non-trivial, connected graph and let $k \in \{2, 3, \dots, \text{rad}(G)\}$. Suppose first that $\text{diam}(G) \geq 2k - 1$. Let $s_1, s_2 \in V(G)$ with $d_G(s_1, s_2) = \text{diam}(G)$. Then, for any $w \in V(G)$,

$$d_G(s_1, w) + d_G(s_2, w) \geq d_G(s_1, s_2) = \text{diam}(G) \geq 2k - 1,$$

so that at least one of $d_G(s_1, w)$, $d_G(s_2, w)$ is at least k , $\{s_1, s_2\}$ is a k -radius-forcing set, and $\rho_k(G) \leq 2$. Since G is non-trivial and connected, $\rho_k(G) = 2$.

For the converse, let $S = \{s_1, s_2\}$ be a minimum k -radius-forcing set of G . Of course, for all $w \in V(G)$, $e_G(w, S) = \max\{d_G(w, s_1), d_G(w, s_2)\} \geq k$. Let $P : (s_1 =) x_0, x_1, \dots, x_m (= s_2)$ be a shortest $s_1 - s_2$ path. Then, for all $i \in \{0, 1, \dots, m\}$, $\max\{d_G(x_i, x_0), d_G(x_i, x_m)\} \geq k$, i.e., $\max\{i, m - i\} \geq k$ for all $i \in \{0, 1, \dots, m\}$. So, $\lceil \frac{m}{2} \rceil = \max\left\{\lceil \frac{m}{2} \rceil, m - \lceil \frac{m}{2} \rceil\right\} \geq k$, whence we obtain $\text{diam}(G) \geq m \geq 2k - 1$. \square

Moon and Moser [MM66] showed that almost all graphs G have diameter two and we see later (see Theorem 4.6.9) that, for these graphs, $\rho_2(G)$ may be arbitrary. However, Theorem 4.6.3 indicates that $\rho_2(H)$ is determined for any connected graph H having diameter at least 3.

Corollary 4.6.4. *If G is a non-trivial connected graph and $k \in \{1, 2, \dots, \text{rad}(G)\}$ satisfies $\text{rad}(G) \geq 2k - 1$, then $\rho_k(G) = 2$.*

Corollary 4.6.5. *Any connected graph G with $\rho_2(G) \geq 3$ is self-centred of radius two.*

An upper bound on ρ_k is given next.

Proposition 4.6.6. *For any non-trivial connected graph G ,*

$$\rho_k(G) \leq \begin{cases} p(G) - 2[\text{rad}(G) - k - 1] - 1 & \text{if } \kappa(G) = 1 \\ p(G) - [\text{rad}(G) - k - 1]\kappa(G) - 1 & \text{if } \kappa(G) \geq 2 \end{cases}$$

for k , $0 \leq k \leq \text{rad}(G)$.

Proof. Let G be any non-trivial connected graph of radius $r \geq 2$, let $v \in C(G)$, let $A_i = \{u \in V(G); d_G(v, u) = i\}$ for $i, 0 \leq i \leq r$, and let $k \in \{2, 3, \dots, r\}$. Let $S = \bigcup_{i=0}^k A_i$. Clearly, $e_G(v, S) = k$. If there exists $i^*, 1 \leq i^* \leq k$, and $y \in A_{i^*}$ with $e_G(y, S) < k$, then

$$\begin{aligned} e_G(y) &= \max\{e_G(y, S), \max\{d_G(y, t); t \in A_{k+1} \cup \dots \cup A_r\}\} \\ &= \max\{e_G(y, S), \max\{d_G(y, y') + r - k; y' \in A_r\}\} \\ &\leq \max\{e_G(y, S), e_G(y, S) + r - k\} \\ &= e_G(y, S) + r - k < r, \end{aligned}$$

an impossibility. So, $\text{rad}(S, G) = e_G(v, S) = k$ and

$$\rho_k(G) \leq |S| = 1 + \sum_{i=1}^k |A_i| = p(G) - \sum_{i=k+1}^r |A_i|.$$

Now notice that $|A_i| \geq 2$ for each $i, 1 \leq i \leq r - 1$ (since, otherwise, if $|A_{i_0}| = 1$ for some $i_0, 1 \leq i_0 \leq r - 1$, then, for a vertex $x \in A_1$ that lies on a shortest $v - t$ path for any $t \in A_r$, we have $e_G(x) \leq \max\{r - 1, i'\} < r$, which is impossible). So, since $|A_i| \geq \kappa(G)$ for each $i, 1 \leq i \leq r - 1$, it follows that, for $m = \max\{2, \kappa(G)\}$,

$$\rho_k(G) \leq p(G) - [r - k - 1]m - 1$$

□

Of course, for $k = \text{rad}(G)$, Proposition 4.6.6 provides a relationship between $\rho_k(G)$ and $\kappa(G)$. As an aside, we mention that there are graphs H for which $\rho(H)$ and $\kappa(H)$ are entirely independent of each other: For $m \in \mathbb{N}, m \geq 3$, replacing each vertex v_i of a cycle $C_m : v_1, v_2, \dots, v_m, v_1$ by a complete graph $H_i \cong K_t$ so that $\langle V(H_i) \cup V(H_{i+1}) \rangle \cong K_{2t}$ produces a graph H with $\kappa(H) = t$ and $\rho(H) = m$ (if m is even) or $\rho(H) = \frac{m+1}{2}$ (if m is odd).

For the sake of convenience, we introduce the following definition.

Definition 4.6.1. For a connected graph G , we shall refer to the $(\text{rad}(G) + 1)$ -tuple $(\rho_0(G), \rho_1(G), \rho_2(G), \dots, \rho_{\text{rad}(G)}(G))$ as the *radius-forcing sequence* of G .

Examples 4.6.7. Graphs having $(1, 2, 3)$ as their radius-forcing sequence include the graphs in Figure 4.3 (see [BH90]).

Besides the class of trees (see Example 4.6.1), the question of what the radius-forcing sequence of a graph looks like has been settled for the r -ciliates, as we show.

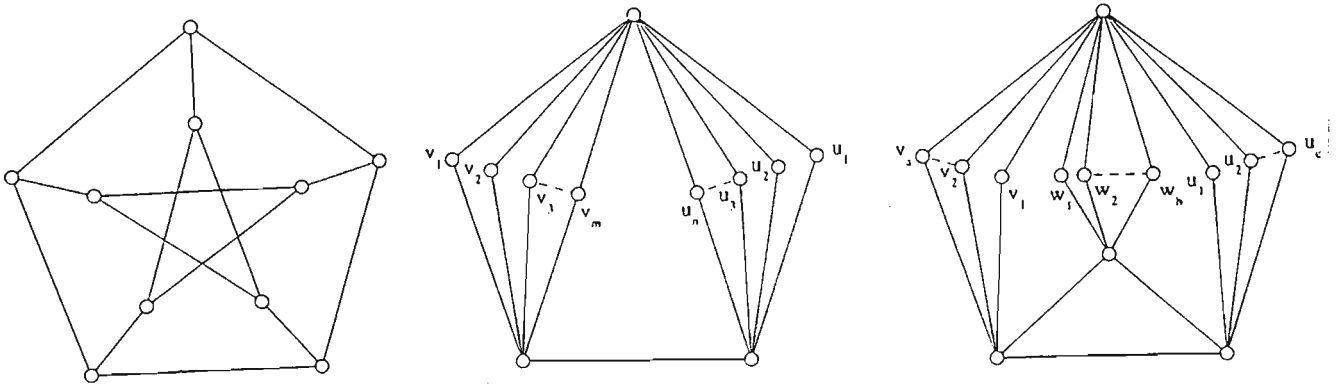

Figure 4.3: Some graphs having $(1,2,3)$ as radius-forcing sequence

Example 4.6.8. If $(1, 2, \rho_2, \dots, \rho_r)$ is the radius-forcing sequence of an r -ciliate $G \cong C_{2a, r-a}$ ($a, r \in \mathbb{N}, 2 \leq a \leq r$), then

$$(1) \rho_i = 2 \text{ for } 2 \leq i \leq \left\lfloor \frac{a}{2} \right\rfloor + r - a,$$

$$(2) \rho_i = j \text{ for } \left\lfloor \frac{2a - q_{j-2} - \left\lfloor \frac{r_{j-2}}{j-1} \right\rfloor}{2} \right\rfloor + r - a + 1 \leq i \leq \left\lfloor \frac{2a - q_{j-1} - \left\lfloor \frac{r_{j-1}}{j} \right\rfloor}{2} \right\rfloor + r - a \text{ where}$$

$$\left. \begin{aligned} 2a &= (j-1)q_{j-2} + r_{j-2}, & 0 \leq r_{j-2} < j-1 \\ 2a &= j \cdot q_{j-1} + r_{j-1}, & 0 \leq r_{j-1} < j \end{aligned} \right\} 3 \leq j \leq a.$$

$$(3) \rho_r = 2a.$$

Proof. That $\rho_r = 2a$ follows from Proposition 4.2.8. Observe that, for a subset S of $V(G)$ of size t , $\text{rad}(S, G)$ is a maximum when S is a set of vertices of the cycle G , if $r = a$, or a set of end-vertices of G , if $a < r$, that are spaced as evenly apart as possible. So, let S be any set of t evenly-spaced vertices of G , that are end-vertices if $a < r$. Suppose that the vertices of the cycle of G are, in order, x_1, x_2, \dots, x_{2a} and suppose that the end-vertices of G (if G has end-vertices) are labelled s_1, s_2, \dots, s_{2a} (if $a = r$, let s_i be an additional label of x_i ($1 \leq i \leq 2a$)), so that s_i is the end-vertex of G closest to x_i ($1 \leq i \leq a$). Then $S = \{s_{i_1}, s_{i_2}, \dots, s_{i_t}\}$ for distinct i_j , $1 \leq j \leq t$. Clearly, for $2a = tq_{t-1} + r_{t-1}$, $0 \leq r_{t-1} < t$, $d = \max\{d_G(x_{i_m}, x_{i_n}); 1 \leq i_m < i_n \leq t\}$ satisfies $d = q_{t-1} + 1$ if $r_t > 0$ and $d = q_{t-1}$ if $r_{t-1} = 0$; without loss of generality, suppose $d = d_G(x_{i_1}, x_{i_2})$. So, $\text{rad}(S, G) = e_G(w, X) + r - a$ where $X = \{x_{i_1}, x_{i_2}, \dots, x_{i_t}\}$ and w is a central vertex of the longest $x_{i_1} - x_{i_2}$ path P in G , which has length $\ell = 2a - q_{t-1} - 1$ if $r_t > 0$ and $\ell = 2a - q_{t-1}$ if $r_{t-1} = 0$, i.e., $\ell = 2a - q_{t-1} - \left\lfloor \frac{r_{t-1}}{t} \right\rfloor$,

and $e_G(w, X) = \text{rad}(P) = \left\lceil \frac{\ell}{2} \right\rceil$. So,

$$\text{rad}(S, G) = \left\lceil \frac{2a - q_{t-1} - \left\lceil \frac{r_{t-1}}{t} \right\rceil}{2} \right\rceil + r - a$$

so that $\rho_i \leq t$ for $2 \leq i \leq \left\lceil \frac{2a - q_{t-1} - \left\lceil \frac{r_{t-1}}{t} \right\rceil}{2} \right\rceil + r - a$ and $\rho_i \geq t + 1$ for $\left\lceil \frac{2a - q_{t-1} - \left\lceil \frac{r_{t-1}}{t} \right\rceil}{2} \right\rceil + r - a + 1 \leq i \leq r$. Results (1) and (2) now follow. (Notice that, if $2a = aq_{a-1} + r_{a-1}$, $0 \leq r_{a-1} < a$, then $r_{a-1} = 0$, $q_{a-1} = 2$ and $\left\lceil \frac{1}{2}(2a - q_{a-1} - \left\lceil \frac{r_{a-1}}{a} \right\rceil) \right\rceil + r - a = r - 1$.) \square

That graphs of radius 2 can have arbitrary radius-forcing number is illustrated by the next result.

Theorem 4.6.9. *The sequence $(1, 2, n)$ is the radius-forcing sequence of some graph for all $n \in \mathbf{N}$, $n \geq 2$.*

Proof. Let $n \in \mathbf{N}$, $n \geq 2$. If $n = 2$, then P_4 has the desired radius-forcing sequence. Suppose $n \geq 3$. Let $A = \{a_1, a_2, \dots, a_n\}$ and B be two disjoint sets of n vertices each. Let B_1, B_2, \dots, B_n be the n distinct subsets of B of size $n - 1$, and form a graph G from an empty graph induced by B and a complete graph induced by A by the insertion of all edges of the form $a_i b$ where $b \in B_i$ ($1 \leq i \leq n$). We will show that $\rho(G) = n$. Notice that $\text{rad}(G) = \text{diam}(G) = 2$.

Suppose $\rho(G) \leq n - 1$; let S be a minimum radius-forcing set of G . Suppose $a_i \in S \cap A$ for some i , $1 \leq i \leq n$. There is only one vertex x for which $d_G(a_i, x) \geq 2$ (and $x \in B$). So, since $|B \cap S| \leq |S| - 1 \leq n - 2 < |B|$, there is a vertex $b' \in B - S$ and $(S - \{a_i\}) \cup \{b'\}$ is also a minimum radius-forcing set of G . In fact, since $|A \cap S| \leq |B - S| - 1$, every vertex $a \in S$ can be replaced by some vertex b_a in B (with $a \neq a'$ implying $b_a \neq b_{a'}$) to produce a new minimum radius-forcing set S' with $S' \subseteq B$ (and $|S'| \leq n - 1$). Now, there exists $i \in \{1, 2, \dots, n\}$ with $S' \subseteq B_i$ and so $e_G(a_i, S') \leq e_G(a_i, B_i) = 1 < \text{rad}(G)$, a contradiction. So, $\rho(G) \geq n$. It is easy to see that $\text{rad}(B, G) = 2 = \text{rad}(G)$. So, $\rho(G) = \rho_2(G) = n$. \square

Notice that it follows immediately from the above theorem that, for any $n \in \mathbf{N}$, there exists a graph G with $\rho(G) = n$. Radius-forcing sequences of length four are characterized next.

Theorem 4.6.10. *For $\rho_2, \rho_3 \in \mathbf{N}$ with $\rho_2, \rho_3 \geq 2$, $(1, 2, \rho_2, \rho_3)$ is the radius-forcing sequence of a graph if and only if $\rho_2 = 2$.*

Proof. The necessity follows from Corollary 4.6.4. To prove that the given condition is sufficient, we let $n \in \mathbf{N}$, $n \geq 2$ be given, let G be the graph described in Theorem 4.6.9, and form the graph G' from G by the subdivision of each edge of G that does not belong to $\langle A \rangle_G$; let C denote the set $V(G') - V(G)$ of these newly introduced vertices. Notice that $\text{rad}(G') = 3$. For j , $1 \leq j \leq n$, let $\{b_j\} = B - B_j$.

Let $i \in \{1, 2, \dots, n\}$. Then, the vertices of G' at distance 1 from a_i are those in $A - \{a_i\}$ and $N_{G'}(a_i)$ ($\subseteq C$). The vertices at distance 2 from a_i are the vertices of $C - N_{G'}(a_i)$ and B_i . The only vertex of G' at distance 3 (or more) from a_i is the vertex b_i . Hence, in any radius-forcing set S of G' , we have $\{b_i; 1 \leq i \leq n\} \subseteq S$, i.e., $|S| \geq n$. So, $\rho(G') \geq n$.

Let $j \in \{1, 2, \dots, n\}$. Then, $d_{G'}(a_j, b_j) = 3$ and $d_{G'}(a_j, b) = 2$, $b \in B_j$. So, $e_{G'}(a_j, B) = 3$. For a vertex $c \in N_{G'}(a_j)$ with $b \in B$ such that $d_{G'}(c, b) = 1$, we have $d_{G'}(c, b') = 3$ for $b' \in B_j - \{b\}$ and $d_{G'}(c, b_j) = 4$; so, $e_{G'}(c, B) = 4$. Finally, $d_{G'}(b, b') = 4$ for any distinct $b, b' \in B$. So, $\text{rad}(B, G') = 3$ and we have $\rho(G') \leq |B| = n$. \square

We conclude this section on k -radius-forcing sets by considering the following problem.

Definition 4.6.2. We define the k -Radius-Forcing Number Problem kRF as follows:

INSTANCE: A connected graph G , integers $k, M \geq 1$.

QUESTION: Is $\rho_k(G) \leq M$?

The NP-completeness of the problem kRF may be proved by a simple and obvious adaptation of the proof used in Section 4.3 to show that the decision problem RF is NP-complete.

Chapter 5

Characterizing sets of domination parameters

5.1 Introduction

Recall that, in a graph G , a vertex subset $D \subseteq V(G)$ is a dominating set if each $v \in V(G) - D$ is adjacent to at least one vertex in D . Having previously considered n -distance domination in graphs, a generalization of the concept of domination obtained by relaxing the requirement of adjacency in the above definition, we next consider some well-known specializations of the domination concept which arise when further restrictions are imposed on the dominating set D .

If $\langle D \rangle_G$, the subgraph induced by a dominating set D of a graph G , is empty or contains no isolated vertex or is connected (whence G is connected) or contains a perfect matching, D is said to be, respectively, an *independent* or *total* or *connected* or *paired dominating set*. The minimum cardinalities of such restricted dominating sets are called the *independent*, *total*, *connected* or *paired domination numbers* of G , denoted by $i(G)$, $\gamma_t(G)$, $\gamma_c(G)$ or $\gamma_p(G)$, respectively.

Examples 5.1.1. 1. For path P_n , we have $\gamma(P_n) = \lceil \frac{n}{3} \rceil = i(P_n)$, $\gamma_t(P_{4k}) = 2k = \gamma_p(P_{4k})$, $\gamma_t(P_{4k+1}) = 2k + 1$, $\gamma_p(P_{4k+1}) = \gamma_t(P_{4k+2}) = \gamma_p(P_{4k+2}) = \gamma_t(P_{4k+3}) = \gamma_p(P_{4k+3}) = 2k + 2$, and $\gamma_c(P_n) = n - 2$ for $n \geq 3$.

2. For the subdivided star $K_{1,t}^*$ on $n = 2t + 1$ vertices obtained by subdividing every edge of the star $K_{1,t}$, we have $\gamma(K_{1,t}^*) = t = i(K_{1,t}^*)$, $\gamma_t(K_{1,t}^*) = t + 1 = \gamma_c(K_{1,t}^*)$, and $\gamma_p(K_{1,t}^*) = 2t$.

3. For the cycle C_n , we have $(\gamma(C_n), \gamma_t(C_n), \gamma_c(C_n), i(C_n)) =$

$$\begin{cases} (\lceil \frac{n}{3} \rceil, 2a, n-2, \lceil \frac{n}{3} \rceil) & \text{if } n = 4a \text{ for some } a \in \mathbf{N} \\ (\lceil \frac{n}{3} \rceil, 2a+1, n-2, \lceil \frac{n}{3} \rceil) & \text{if } n = 4a+1 \text{ for some } a \in \mathbf{N} \\ (\lceil \frac{n}{3} \rceil, 2a+2, n-2, \lceil \frac{n}{3} \rceil) & \text{if } n = 4a+2 \text{ for some } a \in \mathbf{N} \\ (\lceil \frac{n}{3} \rceil, 2a+2, n-2, \lceil \frac{n}{3} \rceil) & \text{if } n = 4a+3 \text{ for some } a \in \mathbf{N} \end{cases}$$

4. For the complete multipartite graph $G = K_{m_1, m_2, \dots, m_t}$, where $t \geq 2$ and $m_i \geq 2$ for $i \in \{1, 2, \dots, t\}$, $(\gamma(G), \gamma_t(G), \gamma_c(G), i(G)) = (2, 2, 2, \min\{m_1, m_2, \dots, m_t\})$.

5. If $k \in \mathbf{N}$ with $k \geq 2$ and $T_{k,h}$ is a complete k -ary tree of height h (i.e., on $h+1$ levels), then

$$(\gamma(T_{k,h}), \gamma_t(T_{k,h}), \gamma_c(T_{k,h}), i(T_{k,h})) = \left(A(k, h), B(k, h), \frac{k^h-1}{k-1}, A(k, h) \right), \text{ where}$$

$$A(k, h) = \begin{cases} \frac{k(k^{h+1}-1)}{k^3-1}, & \text{if } h \equiv 2 \pmod{3} \\ 1 + \frac{k^2(k^h-1)}{k^3-1}, & \text{if } h \equiv 0 \pmod{3} \\ 1 + \frac{k^3(k^{h-1}-1)}{k^3-1}, & \text{if } h \equiv 1 \pmod{3} \end{cases}$$

and

$$B(k, h) = \begin{cases} \frac{k(k+1)(k^{h+1}-1)}{k^4-1}, & \text{if } h \equiv 3 \pmod{4} \\ 1 + \frac{k^2(k+1)(k^h-1)}{k^4-1}, & \text{if } h \equiv 0 \pmod{4} \\ 2 + \frac{k^3(k+1)(k^{h-1}-1)}{k^4-1} & \text{if } h \equiv 1 \pmod{4} \\ 1 + k + \frac{k^4(k+1)(k^{h-2}-1)}{k^4-1} & \text{if } h \equiv 2 \pmod{4} \end{cases}$$

Notice from Examples 5.1.1 1 and 2 that $\gamma_p(P_n) \approx \frac{n}{2}$ while $\gamma_c(P_n) \approx n$, and $\gamma_c(K_{1,t}^*) \approx \frac{n}{2}$ while $\gamma_p(K_{1,t}^*) \approx n$ for $n = 2t + 1$. Specifically, γ_p and γ_c are incomparable. However, $\gamma(G) \leq \gamma_t(G) \leq \gamma_p(G)$ and $\gamma(G) \leq \gamma_t(G) \leq \gamma_c(G)$. That γ_t and i are incomparable can be seen from the tree T in Figure 5.1, where $n \geq 1$, $\gamma_t(T) = 2n + 1$ and $i(T) = n + 1 < \gamma_t(T)$, and from the double star $S = S(a, b)$, $a \leq b$, where $\gamma_t(S) = 2 < a + 1 = i(S)$ if $a \geq 2$, and $\gamma_t(S) = 2 = a + 1 = i(S)$ if $a = 1$.

To date there have been over 880 papers published on domination-related concepts. Survey papers on domination include [CH75], [Coc78], [LW80], [HLP85] and [Hen]. Also, for a comprehensive bibliography of papers on dominating sets in graphs, see the bibliography compiled by Hedetniemi and Laskar [HL90]. Currently, a comprehensive bibliography is being compiled by Theresa W. Haynes and is due to appear in 1996, together with two books on domination by T. W. Haynes and P. J. Slater. We

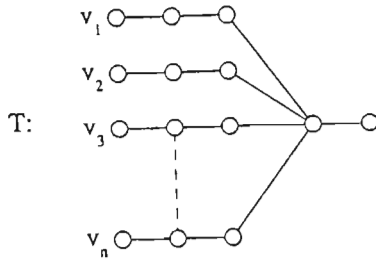

Figure 5.1: A tree illustrating the incomparability of γ_t and i

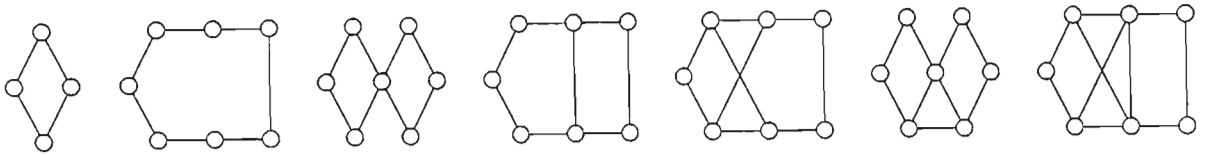

Figure 5.2: The graphs in \mathcal{B}

shall present a brief synopsis of results pertaining to relations between and bounds on the parameters γ , i , γ_t and γ_c .

In [Ore62], Ore showed that, for any graph G of order p with no isolated vertex, $\gamma(G) \leq \frac{1}{2}p(G)$ holds. We give next some further general bounds on γ .

The following result was established independently by Fink et al. in [FJKR85] (for connected graphs) and Payan and Xuong in [PX82] (for general graphs).

Theorem 5.1.2 ([FJKR85, PX82]). *A graph G without isolated vertices has $\gamma(G) = \frac{1}{2}p(G)$ if and only if the components of G are C_4 or $H \circ K_1$ for some connected graph H .*

In [MS89], McCuaig and Shepherd showed that, if we impose some stronger conditions on a graph, the bound $\gamma \leq \frac{1}{2}p$ can be improved.

Theorem 5.1.3. *If G is a connected graph with $\delta(G) \geq 2$ and $G \notin \mathcal{B}$ where \mathcal{B} is the set of graphs in Figure 5.2, then $\gamma(G) \leq \frac{2}{5}p(G)$.*

In [JP72], Jaeger and Payan proved the following Nordhaus-Gaddum type result for the domination number.

Theorem 5.1.4 ([JP72]). *For any graph G ,*

1. $\gamma(G) + \gamma(\bar{G}) \leq p(G) + 1$
2. $\gamma(G) \cdot \gamma(\bar{G}) \leq p(G)$

Further results relating $\gamma(G)$ and $\gamma(\bar{G})$ for a graph G are given in [PX82] as follows.

Theorem 5.1.5 ([PX82]). *If G is a graph, then*

$$(\gamma(G) - 2)(\gamma(\bar{G}) - 1) \leq \delta(\bar{G}) - 1.$$

If equality holds, then

$$\Delta(G) \geq \binom{(\gamma(G) - 2)(\gamma(\bar{G}) - 1) + 1}{\gamma(\bar{G}) - 1}.$$

Furthermore, if G is a graph for which $\gamma(G), \gamma(\bar{G}) \geq 3$, then

$$\gamma(G) \cdot \gamma(\bar{G}) + (\gamma(G) - 3)(\gamma(\bar{G}) - 3) \leq p(G).$$

Joseph and Arumugam [JA] showed that the result in Theorem 5.1.4 can be improved if we impose the condition that both G and \bar{G} have no isolated vertices.

Theorem 5.1.6 (Joseph, Arumugam [JA]). *If G is a graph of order $p \geq 2$ such that G and \bar{G} have no isolated vertices, then $\gamma(G) + \gamma(\bar{G}) \leq \frac{1}{2}(p + 4)$.*

Now, obviously, $\gamma(G) \leq \alpha(G)$, from which follows $\gamma(G) + \beta(G) \leq p(G)$ (as also observed in [MM75] for trees). In [LW80], Laskar and Walikar related α and β to γ .

Theorem 5.1.7 ([LW80]). *If G is a non-trivial graph with no isolates, the following three conditions are equivalent.*

1. $\gamma(G) = \alpha(G)$.
2. $\gamma(G) + \beta(G) = p(G)$.
3. *There exists a minimum dominating set D of G for which $V(G) - D$ is a maximal independent set.*

In [WAS], Walikar et al. proved the following equivalent conditions for trees.

Theorem 5.1.8. *Let T be a tree of order $p \geq 2$. Then the following are equivalent:*

1. $\gamma(T) \cdot \gamma(\bar{T}) = p$.
2. $\gamma(T) = \frac{p}{2}$.
3. $\gamma(T) = \beta(T)$.
4. $T = T \circ K_1$ for some tree T_1 .

In [Pay75], Payan gave some upper bounds on γ in terms of p and δ .

Theorem 5.1.9 ([Pay75]). *Let G be a graph of order p and minimum degree δ . Then*

$$\gamma(G) \leq \frac{\log[\delta + 1]}{\log\left[\frac{1}{1 - \frac{1}{p}(\delta + 1)}\right]} + \frac{p}{\delta + 1}$$

and

$$\gamma(G) \leq \frac{p}{\delta + 1} \sum_{j=1}^{\delta+1} \frac{1}{j} \sim \frac{p \log \delta}{\delta}$$

In the same paper, Payan proved the results given in Theorem 5.1.10 (the first being proved independently by Marcu [Mar85]) and (without proof) stated the result in Theorem 5.1.11. A proof of this latter result is supplied by Flach and Volkman in [FV90] (see Theorems 5.1.13 and 5.1.14).

Theorem 5.1.10 ([Pay75]). *For a graph G without isolated vertices,*

$$\gamma(G) \leq \frac{1}{2} \left(p(G) + 2 - \delta(G) \right)$$

and

$$\gamma(G) \leq \frac{(p(G) - 1 - \Delta(G))(p(G) - 2 - \delta)}{p(G) - 1} + 2.$$

Theorem 5.1.11 ([Pay75]). *For a graph G without isolated vertices not isomorphic to the complement of a one-regular graph or with at least one component not isomorphic to a square,*

$$\gamma(G) \leq \frac{1}{2} \left(p(G) + 1 - \delta(G) \right).$$

In [FV90], Flach and Volkmann established a further two bounds on $\gamma(G)$.

Theorem 5.1.12 ([FV90]). *For a graph G without isolated vertices,*

$$2\gamma(G) \leq p(G) + 1 - \frac{\Delta(G)(\delta(G) - 1)}{\delta(G)}$$

and

$$2\gamma(G) \leq p(G) - (\delta(G) - 2)P_2(G) \leq p(G) - \frac{p(G)(\delta(G) - 2)}{[\Delta(G)]^2 + 1}.$$

Theorem 5.1.13 ([FV90]). *If G is a connected graph and not isomorphic to the complement of a one-regular graph, then $\gamma(G) \leq \frac{1}{2}(p(G) + 1 - \delta(G))$.*

Theorem 5.1.14 ([FV90]). *If G is a disconnected graph without isolated vertices and at least one component not isomorphic to a square, then we have again $2\gamma(G) \leq p(G) + 1 - \delta(G)$.*

Reminiscent of the classical theorem of Turán, Vizing [Viz65] obtained an upper bound on the number of edges in a graph of given order and domination number.

Theorem 5.1.15 (Vizing [Viz65]). *If G is a (p, q) graph with domination number γ at least 2, then*

$$q \leq \left\lfloor \frac{1}{2}(p - \gamma)(p - \gamma + 2) \right\rfloor.$$

In [Viz65], Vizing shows that this bound is sharp by constructing a family of graphs G satisfying $\Delta(G) = p(G) - \gamma(G)$ for which the bound is attained. If $\Delta < p - \gamma$ is added as a condition, then, as Sanchis [San91] shows, Vizing's bound can be improved.

Theorem 5.1.16 (Sanchis [San91]). *If G is a (p, q) graph with domination number γ at least 2 and $\Delta(G) \leq p - \gamma - 1$, then*

$$q \leq \frac{1}{2}(p - \gamma)(p - \gamma + 1).$$

In [Ber62], Berge gave an upper and lower bound on γ in terms of p , q and Δ .

Theorem 5.1.17 ([Ber62]). *If G is a graph, then $p(G) - q(G) \leq \gamma(G) \leq p(G) - \Delta(G)$.*

The upper bound of $p(G) - \Delta(G)$ is attainable by the graph $H \circ K_1$ for any graph H with $\gamma(H) = 1$, while in [WSA78], Walikar et al. showed that $\gamma(G) = p(G) - q(G)$ for a graph G if and only if G is a star. Moreover, in [WSA], Walikar et al. gave a lower bound on γ in terms of p and Δ as follows.

Theorem 5.1.18. *For a graph G ,*

$$\left\lceil \frac{p}{1 + \Delta(G)} \right\rceil \leq \gamma(G) \leq p(G) - \kappa(G).$$

Furthermore, $\gamma(G) = \frac{p}{1 + \Delta(G)}$ if and only if $V(G)$ can be partitioned into subsets V_1 and V_2 with $\gamma(G) = |V_1| = |V_2|$ satisfying all the following conditions:

- (i) V_1 is independent.
- (ii) For $u \in V_2$, there exists a unique $v \in V_1$ such that $N_G(u) \cap V_1 = \{v\}$,
- (iii) $\deg_G(u) = \Delta(G)$ for every $u \in V_1$.

A further bound on γ involving p and q is provided by Vizing in [Viz65].

Theorem 5.1.19. *For a (p, q) graph G , $\gamma(G) \leq p + 1 - \sqrt{1 + 2q}$.*

Before moving on to inequalities involving the independent domination number, we present two final simple upper bounds on γ in terms of independent and covering numbers given by Henning in [Hen].

Theorem 5.1.20 ([Hen]). *If G is a graph with no isolates, then*

$$\gamma(G) \leq \min\{\alpha(G), \alpha_1(G), \beta(G), \beta_1(G)\}$$

and

$$\gamma(G) \leq \frac{\alpha_1(G) + \beta_1(G)}{2} = \frac{p}{2}.$$

A set of vertices of a graph is both independent and dominating if and only if it is a maximal independent set (see [Ber73, p. 309]). For work on these sets, see, for example, [AL78, CH76]. The *independent domination number*, $i(G)$, of a graph G is the smallest cardinality of a maximal independent set of vertices of G . This parameter was introduced by Cockayne and Hedetniemi in [CH76]. We begin our presentation of inequalities involving the independent domination number with a simple (but sharp) upper bound involving the order of a connected bipartite graph.

Proposition 5.1.21. *If G is any connected bipartite graph of order $p \geq 2$, then $i(G) \leq \frac{p}{2}$.*

Proof. The vertex set of every bipartite graph is the union of two independent sets, each of which, in a connected bipartite graph, dominates the other. \square

Obviously, the domination number of a graph provides an immediate lower bound on the independent domination number of the graph. Some upper bounds on i in terms of γ and p are given next. We begin with a result of Bollobás and Cockayne [BC79].

Theorem 5.1.22 ([BC79]). *If G is a graph with no isolated vertices, then*

$$i(G) \leq p(G) - \gamma(G) + 1 - \left\lfloor \frac{p(G) - \gamma(G)}{\gamma(G)} \right\rfloor.$$

We note that, for a graph G , we have $p(G) + 2 - \sqrt{p(G)} \geq p(G) - \gamma(G) + 1 - \left\lfloor \frac{p(G) - \gamma(G)}{\gamma(G)} \right\rfloor$ with equality if and only if $\gamma(G) = \sqrt{p(G)}$; hence, although the bound established by Gimbel and Vestergaard (see below) is sharp, the inequality in Theorem 5.1.22 gives the better bound.

Theorem 5.1.23 (Gimbel, Vestergaard [GV]). *If G is any connected graph of order $p \geq 2$, then $i(G) \leq p + 2 - 2\sqrt{p}$, and this bound is sharp.*

In [BC79], Bollobás and Cockayne also proved

Theorem 5.1.24 ([BC79]). *If G is a graph containing no induced subgraph isomorphic to $K_{1,k+1}$, ($k \geq 2$), then $i(G) \leq (k-1)\gamma(G) - (k-2)$.*

Setting $k = 2$ in the above theorem yields the following sufficient (but not necessary) condition for the independent domination number of a graph to be equal to its domination number.

Corollary 5.1.25 (Allan, Laskar [AL78]). *If a graph G has no induced subgraph isomorphic to $K_{1,3}$, then $\gamma(G) = i(G)$.*

Graphs for which the bound in Theorem 5.1.24 is attained are given in [Hen], in which Henning also points out that, as an immediate consequence of Corollary 5.1.25, every $K_{1,3}$ -free graph is domination perfect, where a graph G is called *domination*

perfect if $\gamma(H) = i(H)$ for every induced subgraph H of G (see [SM79] for the original definition of domination perfect graphs). In [AL78], it was shown that $\gamma(L(G)) = i(L(G))$ for any graph G , extending the result of Mitchell and Hedetniemi [MH77] that $\gamma(L(T)) = i(L(T))$ for any tree T . By describing an infinite class of cubic 3-connected graphs for which $i \neq \gamma$, Mynhardt disproved in [Myn91] a conjecture of Barefoot, Harary and Jones [BHJ91] that $K_{3,3}$ and $C_5 \times K_2$ are the only 3-connected cubic graphs for which the domination and independent domination numbers differ. Also in [Myn91], Mynhardt proved a further conjecture of Barefoot et al. that there exists an infinite class of cubic graphs with connectivity one for which $i - \gamma$ becomes unbounded, by constructing a class of graphs satisfying the given requirements.

Finally, we have an upper bound on $\gamma(G) + i(G)$:

Theorem 5.1.26 ([ALH84]). *If G is a graph with no isolates, then $\gamma(G) + i(G) \leq p(G)$.*

We turn our attention now to the total domination number. The notion of total domination was introduced in [ALH84] and [CDH80]. In [CDH80], Cockayne, Dawes and Hedetniemi proved the following results.

Theorem 5.1.27. *Let G be a graph of order p .*

1. *If G is connected with $p \geq 3$, then $\gamma_t(G) \leq \frac{2p}{3}$.*
2. *If G has no isolates, then $\gamma_t(G) \leq p - \Delta(G) + 1$.*
3. *If G is connected and $\Delta(G) < p - 1$, then $\gamma_t(G) \leq p - \Delta(G)$.*
4. *If G has no isolates and $\Delta(G) < p - 1$, then $\gamma_t(G) + \gamma_t(\bar{G}) \leq p + 2$ with equality if and only if $mK_2 \in \{G, \bar{G}\}$.*

In [ALH84], Allan et al. related the independent domination number and the total domination number (see Theorem 5.1.28), and noted the consequent corollary.

Theorem 5.1.28 ([ALH84]). *If G is a graph each component of which has order at least three, then $i(G) + \gamma_t(G) \leq p(G)$; hence $\gamma(G) + \gamma_t(G) \leq p(G)$.*

In [CDH80], Cockayne, Dawes and Hedetniemi proved also that

Theorem 5.1.29. *If G is a graph without isolates vertices, then*

$$i(G) \leq p(G) + 1 - \left\lceil \frac{p(G) - \gamma_t(G)}{\gamma_t(G)} \right\rceil - \frac{\gamma_t(G)}{2}.$$

The notion of connected domination was introduced by Sampathkumar and Walikar [SW79] in 1979, and besides the elementary relationship $\gamma(G) \leq \gamma_t(G) \leq \gamma_c(G)$, the following results were established for a connected graph G in [SW79].

Proposition 5.1.30. *1. Let e denote the number of end-vertices in a tree with*

$p > 2$ vertices. Then, $\gamma_c(T) = p - e$.

2. Let H be a connected spanning subgraph of a connected graph G . Then, $\gamma_c(G) \leq \gamma_c(H)$.

3. For any connected graph G with $|V(G)| \geq 3$, $\gamma_c(G) \leq p - 2$.

4. Let G be a connected graph with p vertices, q edges and maximum degree Δ , then $\frac{p}{\Delta+1} \leq \gamma_c(G) \leq 2q - p$. Furthermore, $\gamma_c(G) = \frac{p}{\Delta+1}$ if and only if $\Delta = p - 1$, i.e., $\gamma_c(G) = 1$, and $\gamma_c(G) = 2q - p$ if and only if G is a path.

In [Nie74], Nieminen showed that, if $\varepsilon_F(G)$ is the maximum number of end-vertices in any spanning forest of a connected graph G , then $\gamma(G) + \varepsilon_F(G) = p(G)$. In [HL84], S. T. Hedetniemi and R. Laskar established a similar result for connected domination, and also produced results for connected domination similar to those given in Theorem 5.1.27. Specifically, they showed that

Proposition 5.1.31. *1. If $\varepsilon_T(G)$ denotes the maximum number of end-vertices*

in a spanning tree of a connected graph G , then $\gamma_c(G) + \varepsilon_T(G) = p(G)$. Hence, since the problem of determining $\varepsilon_T(G)$ for an arbitrary connected graph G is NP-complete (see [GJ84]), it follows that the problem of determining $\gamma_c(G)$ for an arbitrary connected graph G is NP-complete.

2. $\gamma_c(G) \leq p(G) - \Delta(G)$ for a connected graph G .

3. The problem of determining $\gamma_c(G)$ for an arbitrary connected graph G is NP-complete.

4. For any connected graph G , $\text{diam}(G) - 1 \leq \gamma_c(G)$.

5. Recall that $\beta_1(G)$ denotes the number of edges in a maximum matching of G . Clearly, $\gamma(G) \leq 2\beta_1(G)$. In fact, every connected graph G contains at least one β_1 -set M such that $\langle V(M) \rangle$ is a connected subgraph, whence it follows that, for every connected graph G , $\gamma_c(G) \leq 2\beta_1(G)$.
6. If G is a graph such that both G and \bar{G} are connected, then $\gamma_c(G) + \gamma(\bar{G}) \leq p(G) + 1$. This bound is best possible (consider, for example, C_5). A corollary that followed provided a slightly improved bound for trees: For any tree of order $p \geq 3$, $\gamma_c(T) + \gamma_c(\bar{T}) \leq p(T)$.

In [DM82], Duchet and Meyniel showed

Theorem 5.1.32. *For a connected graph G , $\gamma_c(G) \leq 2\beta(G) - 1$ and $\gamma_c(G) \leq 3\gamma(G) - 2$.*

In [NWDB88], Newman-Wolfe et al. proved the following result concerning $\gamma(G)$ and $\gamma_c(G)$. Note that Proposition 5.1.33 always applies to either G or \bar{G} and that self-complementary H graphs have $\gamma(H) \leq \gamma_c(H) \leq \gamma(H) + 1$.

Proposition 5.1.33 ([NWDB88]). *If G is connected and either $\gamma_c(G) \leq \gamma_c(\bar{G})$ or \bar{G} is disconnected, then $\gamma(G) \leq \gamma_c(G) \leq \gamma(G) + 1$.*

The following sequence involving the lower and upper independence, domination, and irredundance numbers first appeared in Cockayne, Hedetniemi and Miller [CHM78] and is well-known.

$$\text{ir}(G) \leq \gamma(G) \leq i(G) \leq \beta(G) \leq \Gamma(G) \leq \text{IR}(G)$$

Various studies have been concerned with deriving sufficient conditions for two or more of these parameters to be equal. One interesting note is that deciding “Is $i(G) < \beta(G)$?” (that is, is G not well-covered) has been shown to be NP-complete [CS93]. However, the complexity of the question “Is $\gamma(G) \leq \Gamma(G)$?” remains unresolved.

Investigation of sequences $(m_1, m_2, m_3, m_4, m_5, m_6)$ for which there exists a graph G with $\text{ir}(G) = m_1$, $\gamma(G) = m_2$, $i(G) = m_3$, $\beta(G) = m_4$, $\Gamma(G) = m_5$, and $\text{IR}(G) = m_6$ was begun by Cockayne, Favaron, Payan and Thomason [CFPT81], and such sequences were completely characterized by Cockayne and Mynhardt [CM93].

Theorem 5.1.34 ([CM93]). *A sequence $(m_1, m_2, m_3, m_4, m_5, m_6)$ of positive integers is realizable as $(\text{ir}(G), \gamma(G), i(G), \beta(G), \Gamma(G), \text{IR}(G))$ for some graph G if and only if*

$$(i) \quad m_1 \leq m_2 \leq \cdots \leq m_6,$$

$$(ii) \quad m_1 = 1 \text{ implies } m_3 = 1,$$

$$(iii) \quad m_4 = 1 \text{ implies } m_6 = 1, \text{ and}$$

$$(iv) \quad m_2 \leq 2m_1 - 1.$$

In [HSb], triples (a, b, c) for which there exists a connected graph G with $\gamma(G) = a$, $\gamma_t(G) = b$, and $\gamma_p(G) = c$ are characterized. For further results on paired domination, see, for example, [HSb, HSA]. In this chapter, we characterize triples (a, b, c) for which there exists a connected graph H with $(a, b, c) = (\gamma(H), i(H), p(H))$, $(\gamma(H), \gamma_t(H), i(H))$, $(\gamma(H), \gamma_c(H), p(H))$, and $(\gamma(H), \gamma_t(H), p(H))$, respectively.

5.2 Characterizing the realizable triples (γ, i, p) , (γ, γ_t, i) , (γ, γ_c, p) and (γ, γ_t, p)

We begin by characterizing those triples (a, b, c) for which there exists a graph G with $(\gamma(G), i(G), p(G)) = (a, b, c)$. Recall a graph G of order p with no isolated vertex has $\gamma(G) \leq \frac{1}{2}p(G)$. We establish our characterization of the triples $(\gamma(G), i(G), p(G))$ with the following two theorems.

Theorem 5.2.1. *For $a, b, c \in \mathbf{N}$, there exists a non-trivial tree T with $(\gamma(T), i(T), p(T)) = (a, b, c)$ if and only if $1 \leq a \leq b \leq \frac{1}{2}c$.*

Proof. The necessity follows from our comments preceding the statement of the theorem. To prove the sufficiency, let $a, b, c \in \mathbf{N}$ satisfy $1 \leq a \leq b \leq \frac{1}{2}c$. If $a = b$, then $T = T(a, 0, c - 2a, 0, 0, \dots, 0)$ (see Figure 5.3) has $\gamma(T) = a = i(T)$ and $p(T) = c$. Otherwise, $b - a + 1 \geq 1$ and, for $b_1 \in \mathbf{N}$ with $b - a + 1 \leq b_1$, and $b_j \in \mathbf{N} \cup \{0\}$, $2 \leq j \leq a - 1$, with $\sum_{i=1}^{a-1} b_i = c + 1 - a - b$, the tree $T = T(a - 1, b - a + 1, 0, b_1, b_2, \dots, b_{a-1})$ in Figure 5.3 is such that $\gamma(T) = a$, $i(T) = b$, and $p(T) = c$. \square

Theorem 5.2.2. *For $a, b, c \in \mathbf{N}$, there exists a connected graph G with $(\gamma(G), i(G), p(G)) = (a, b, c)$ if and only if*

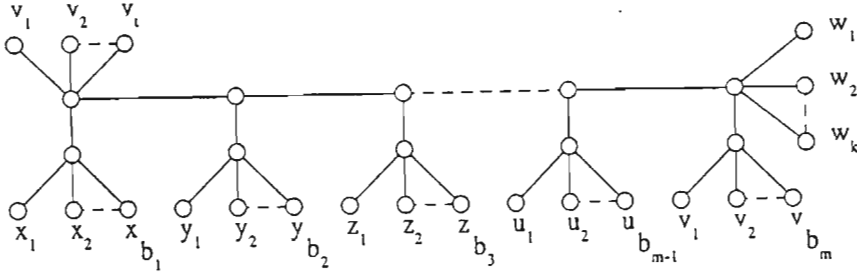

Figure 5.3: A tree $T(m, t, k, b_1, b_2, \dots, b_m)$ with $(\gamma(T), i(T), p(T)) = (a, b, c)$

- (i) $2 \leq a \leq \frac{c}{2}$,
- (ii) $\frac{c}{2} + 1 \leq b \leq c - 1$,
- (iii) $a \leq b$,
- (iv) $b \leq c - a + 1 - \left\lceil \frac{c-a}{a} \right\rceil$, and
- (v) $a + b \leq c$.

Proof. That $i(G) \leq p(G) - 1$ for a graph G without isolated vertices follows from the obvious observation that $i(G) \leq \beta(G)$ and Gallai's result [Gal59] that $\alpha(G) + \beta(G) = p(G)$. For the validity of $i(G) \leq p(G) - \gamma(G) + 1 - \left\lceil \frac{p(G) - \gamma(G)}{\gamma(G)} \right\rceil$, see Theorem 5.1.22, and of $\gamma(G) + i(G) \leq p(G)$, see Proposition 5.1.26. For the converse, suppose that $a, b, c \in \mathbb{N}$ satisfy conditions (i) – (v). For $m_1, m_2, \dots, m_a \in \mathbb{N}$ with $m_1 \geq m_2 \geq \dots \geq m_a$, $\sum_{i=1}^a m_i + a = c$ (whence $m_1 \geq \frac{c-a}{a}$) and $\sum_{i=2}^a m_i = b - 1$, let $G(a, m_1, m_2, \dots, m_a)$ be the graph obtained from the disjoint union of a stars $K_{1, m_1}, K_{1, m_2}, \dots, K_{1, m_a}$ by the pair-wise joining of all the centres of these stars. Then, for $G = G(a, m_1, m_2, \dots, m_a)$, $\gamma(G) = a$, $i(G) = b$, and $p(G) = c$. \square

Next, we characterize the triples (γ, γ_t, i) for which there exists a graph G with $(\gamma(G), \gamma_t(G), i(G)) = (a, b, c)$. First, we have the following proposition.

Proposition 5.2.3. *If G is a graph for which $\gamma_t(G) \in \{2\gamma(G) - 1, 2\gamma(G)\}$, then $\gamma(G) = i(G)$.*

Proof. Let G be a graph for which $\gamma_t(G) \in \{2\gamma(G) - 1, 2\gamma(G)\}$. Let $\gamma = \gamma(G)$, $\gamma_t = \gamma_t(G)$, let D be a minimum dominating set of G , and let the components of $\langle D \rangle_G$ be D_1, D_2, \dots, D_t . (So, $t \leq \gamma$.) We claim that $D_i \cong K_1$ for each i , $1 \leq i \leq t$. Suppose,

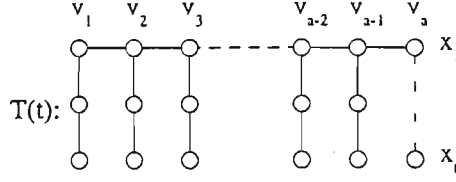

Figure 5.4: A tree $T(t)$ for Case 2 of Theorem 5.2.4 with $(\gamma(T), \gamma_t(T), i(T)) = (a, b, c)$

to the contrary, that $t < \gamma$; without loss of generality, assume that D_1, D_2, \dots, D_ℓ ($1 \leq \ell \leq t$) are the components of $\langle D \rangle_G$ of order at least 2. Then, if, for each vertex $x \in \cup_{i=1}^\ell D_i$, we pick $u_x \in N_G(x)$, it follows that $D \cup \{u_x; x \in D - \cup_{i=1}^\ell D_i\}$ is a total dominating set of G , whence $\gamma_t(G) \leq |D| + t - \ell < 2\gamma - \ell \leq 2\gamma - 1$. This contradicts our assumption. \square

So, we have

Theorem 5.2.4. *For $a, b, c \in \mathbb{N}$, there exists a graph G with $(\gamma(G), \gamma_t(G), i(G)) = (a, b, c)$ if and only if $(a, b, c) = (1, 2, 1)$ or*

- (i) $2 \leq a \leq c$,
- (ii) $2 \leq b$,
- (iii) $a \leq b \leq 2a$, and
- (iv) $a = c$ if $b = 2a$ or $b = 2a - 1$.

In fact, if conditions (i) – (iv) are satisfied, this graph can always be required to be a tree.

Proof. The necessity follows from our earlier comments. To prove the sufficiency, we let $a, b, c \in \mathbb{N}$ satisfying (i) – (iv). We consider four cases.

Case 1: If $(a, b, c) = (1, 2, 1)$, then the star $K_{1,m}$ for any $m \in \mathbb{N}$ realizes (a, b, c) .

Case 2: Suppose $b \in \{2a - 1, 2a\}$ and $a = c$. Then, for $t = 2$ if $b = 2a - 1$, and $t = 3$ if $b = 2a$, the tree $T = T(t)$ in Figure 5.4 has $(\gamma(T), \gamma_t(T), i(T)) = (a, b, c)$.

Case 3: Suppose $2 \leq a \leq c$ and $b = a$. Then, the tree T in Figure 5.5 has $(\gamma(T), \gamma_t(T), i(T)) = (a, b, c)$ for $t \geq c - a + 1$.

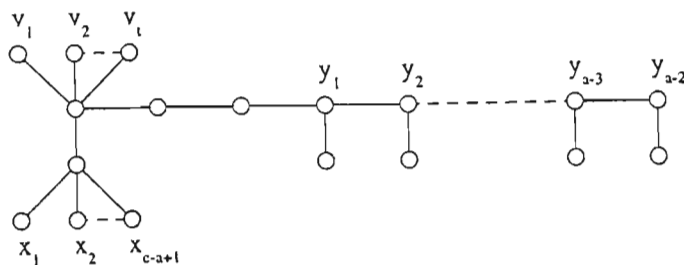

Figure 5.5: A tree T for Case 3 of Theorem 5.2.4 with $(\gamma(T), \gamma_t(T), i(T)) = (a, b, c)$

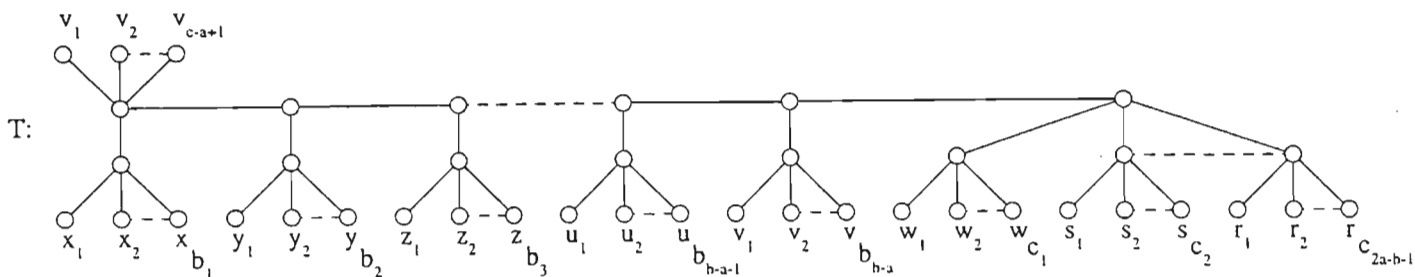

Figure 5.6: A tree T for Case 4 of Theorem 5.2.4 with $(\gamma(T), \gamma_t(T), i(T)) = (a, b, c)$

Case 4: Suppose $3 \leq a + 1 \leq b \leq 2a - 2$ and $a \leq c$. Then, for $b_1, b_2, \dots, b_{b-a} \in \mathbb{N} \cup \{0\}$ with $b_i = 0$ for at most one $i \in \{1, 2, \dots, \gamma_t - \gamma\}$ and $b_1 \geq c - a + 1$, and for $c_1, c_2, \dots, c_{2a-b-1} \in \mathbb{N}$, the tree T in Figure 5.6 has $\gamma(T) = a$, $\gamma_t(T) = b$ and $i(T) = c$. \square

Before going on to give a characterization of the triples (a, b, c) for which there exists a connected graph G with $(\gamma(G), \gamma_c(G), p(G)) = (a, b, c)$, we present some further results concerning the connected domination number. First, we present the following, which may be deduced from Theorem 5.1.2 but for which we now present an alternative proof.

Theorem 5.2.5. *If G is a connected graph of even order $p \geq 2$ and $\gamma(G) = \frac{1}{2}p$, then $\gamma_c(G) = \gamma_t(G) = \frac{p}{2} = \gamma(G)$.*

Proof. Suppose, to the contrary, there exists a connected graph G of even order $p \geq 2$ such that $\gamma(G) = \frac{1}{2}p$ and $\gamma_c(G) > \frac{1}{2}p$. Then, any minimum dominating set of

G induces a disconnected graph in G . Let D be a $\gamma(G)$ -set for which $\langle D \rangle_G$ has the least number of components. Clearly, every vertex in a component of $\langle D \rangle_G$ having order at least two has a private neighbour in $V(G) - D$. Furthermore, every vertex w that is isolated in $\langle D \rangle_G$ has a private neighbour in $V(G) - D$ since, otherwise, if y is an element of the non-empty set of neighbours of w in $V(G) - D$ (non-empty as G is connected and non-trivial), then $|N_G(y) \cap D| \geq 2$ and $D^* = (D - \{w\}) \cup \{y\}$ is a minimum dominating set of G that induces a graph with fewer components than D , a contradiction. So, every vertex of D has a private neighbour in $V(G) - D$; since $|V(G) - D| = \frac{p}{2} = |D|$, it follows that every vertex of D has exactly one private neighbour and that every vertex of $V(G) - D$ is the private neighbour of exactly one vertex of D . Now, suppose that $\langle D \rangle_G$ has a component D' of order at least two. Since G is connected, there exists a shortest path $P : x_0, x_1, \dots, x_r$ which connects a vertex of D' to a vertex in $D - V(D')$; say $x_0 = v \in V(D')$. Then $x_1 = v'$, the private neighbour of v and $x_2 \in V(G) - D$, say $x_2 = w'$, where w' is the private neighbour of $w \in D$. By the minimality of P , w is contained in a component $D'' \neq D'$ of $\langle D \rangle_G$ and P is v, v', w', w . Then, $(D - \{w, v\}) \cup \{w'\}$ is a set of cardinality $\gamma(G) - 1$ that dominates G , a contradiction. So, every vertex of D is isolated in $\langle D \rangle_G$ and has degree one in G . However, since G is connected, $\langle V(G) - D \rangle_G$ is connected and $V(G) - D$ is also a dominating set of G with $|V(G) - D| = \frac{p}{2} = \gamma(G)$, which contradicts our assumption about $\gamma_c(G)$. Hence, it follows that a $\gamma(G)$ -set D exists such that $\langle D \rangle_G$ is connected and consequently $\gamma_c(G) = \gamma(G) = \frac{p}{2}$. \square

Furthermore, in [DM82], Duchet and Meyniel proved that $\gamma_c(G) \leq 3\gamma(G) - 2$ for a connected graph G (see also Theorem 5.3.1 for a proof). Moreover, the following proposition holds.

Proposition 5.2.6. *If G is a connected graph of order $p \geq 2$, then $\gamma_c(G) = p - 2$ if and only if G is a path or a cycle.*

Proof. If $G \cong C_n$ or $G \cong P_n$ for $n \in \mathbb{N}$, $n \geq 3$, then $\gamma_c(G) = p - 2$. Conversely, suppose that G is a connected graph of order $p \geq 3$ with $\gamma_c(G) = p - 2$. By Proposition 5.1.31, $\gamma_c(H) + \varepsilon_T(H) = p(H)$ for any connected graph H , where $\varepsilon_T(H)$ is the maximum number of end-vertices in a spanning tree of H . So, $\gamma_c(G) = p - 2$ implies that $\varepsilon_T(G) = 2$, i.e., every spanning tree of G is a (non-trivial) path. That $\Delta(G) \leq 2$ follows from the observation that, if $\deg_G(v) \geq 3$ for some $v \in V(G)$, then a distance-preserving (breadth-first search) spanning tree of G rooted at v has at least three end-vertices. \square

Corollary 5.2.7. *If G is a connected graph of order $p \geq 3$ with $\gamma_c(G) = p - 2$, then $\gamma(G) = \left\lceil \frac{p}{3} \right\rceil$.*

The following theorem leads to a relationship between γ , γ_c and p .

Theorem 5.2.8. *For a non-trivial tree T of order p and ε_T end-vertices,*

$$\gamma(T) \leq \frac{p + \varepsilon_T}{3}. \quad (5.2.1)$$

Proof. We begin by noting that $\frac{1}{3}(p + \varepsilon_T(T)) = \frac{1}{3}(2p - 1) \geq 1 = \gamma(T)$ for any non-trivial star $T = K_{1,p-1}$, so it remains to show that the inequality 5.2.1 holds for non-trivial trees that are not stars.

We proceed by induction on p . By inspection, it is easily verified that 5.2.1 holds for all non-trivial trees of order $p \leq 6$. Now suppose that 5.2.1 holds for all non-trivial trees of order p and consider a tree T with $p(T) = p \geq 7$ and ε_T end-vertices, where T is not a star. Let $P : v_0, v_1, \dots, v_k$ be a diametral path of T (note that $k \geq 3$, since T is not a star). We consider three cases; in each case we shall define a subtree T' of T and denote by D' a $\gamma(T')$ -set.

Case 1: Suppose $\deg_T v_1 = \deg_T v_2 = 2$. Let $T' = T - \{v_0, v_1, v_2\}$. Then, $D' \cup \{v_1\}$ dominates T and $\varepsilon_{T'} \leq \varepsilon_T$. So, by the inductive hypothesis,

$$\gamma(T) \leq 1 + \gamma(T') \leq 1 + \frac{p(T') + \varepsilon_{T'}}{3} \leq 1 + \frac{p - 3 + \varepsilon_T}{3} = \frac{p + \varepsilon_T}{3}.$$

Case 2: Suppose $\deg_T v_1 \geq 3$. If $\deg_T v_2 \geq 3$, then letting T' be obtained by the removal from T of v_1 and all end-vertices of T adjacent to v_1 and noting that $D' \cup \{v_1\}$ dominates T , we have

$$\gamma(T) \leq 1 + \gamma(T') \leq 1 + \frac{p(T') + \varepsilon_{T'}}{3} \leq 1 + \frac{p - 3 + \varepsilon_T - 2}{3} < \frac{p + \varepsilon_T}{3}.$$

If $\deg_T v_2 = 2$, then letting T' be obtained by the removal from T of v_1, v_2 and all end-vertices of T adjacent to v_1 and noting that $D' \cup \{v_1\}$ is a dominating set of T , we have

$$\gamma(T) \leq 1 + \gamma(T') \leq 1 + \frac{p(T') + \varepsilon_{T'}}{3} \leq 1 + \frac{p - 4 + \varepsilon_T - 1}{3} < \frac{p + \varepsilon_T}{3}.$$

Case 3: Suppose $\deg_T v_1 = 2$ and $\deg_T v_2 \geq 3$. Letting $T' = T - \{v_0, v_1\}$ and noting that $D' \cup \{v_1\}$ dominates T , we have

$$\gamma(T) \leq 1 + \gamma(T') \leq 1 + \frac{p(T') + \varepsilon_T(T')}{3} = 1 + \frac{p - 2 + \varepsilon_T - 1}{3} = \frac{p + \varepsilon_T}{3}.$$

□

Corollary 5.2.9. *For any non-trivial connected graph G ,*

$$3\gamma(G) + \gamma_c(G) \leq 2p(G).$$

Proof. Let G be any non-trivial connected graph, and let T be a spanning tree of G with $\varepsilon_T(G)$ end-vertices. Then, since $\gamma(G) \leq \gamma(T)$, we have, by Proposition 5.1.31 and the above theorem, that

$$\begin{aligned} 3\gamma(G) + \gamma_c(G) &\leq 3\gamma(T) + \gamma_c(G) \\ &\leq p(T) + \varepsilon_T(T) + \gamma_c(G) \\ &= p(G) + \varepsilon_T(G) + p(G) - \varepsilon_T(G) \\ &= 2p(G). \end{aligned}$$

□

We note that Theorem 5.1.2 is also a consequence of Corollary 5.2.9. We can now present a characterization of the triples (a, b, c) for which there exists a graph G with $(\gamma(G), \gamma_c(G), p(G)) = (a, b, c)$.

Theorem 5.2.10. *Given $a, b, c \in \mathbf{N}$, $(\gamma(G), \gamma_c(G), p(G)) = (a, b, c)$ for some connected graph G if and only if $(a, b, c) = (1, 1, c)$ or*

(i) $2 \leq a \leq b$,

(ii) $b \leq c - 3$ or $b = c - 2$ and $a = \lceil \frac{c}{3} \rceil$,

(iii) $a \leq \frac{c}{2}$,

(iv) $b \leq 3a - 2$,

(v) $3a + b \leq 2c$, and hence, if $a = \frac{c}{2}$, then $b = \frac{c}{2}$.

In fact, if conditions (i) – (v) are satisfied, this graph can always be required to be a tree.

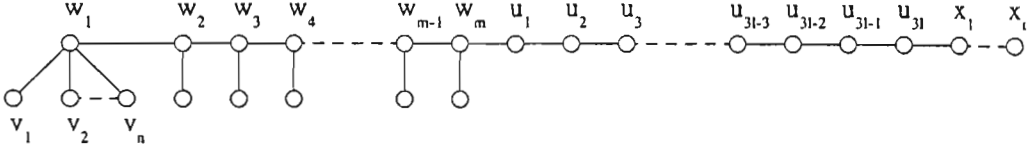

Figure 5.7: The tree $T(n, m, \ell, t)$

Proof. The necessity of the conditions (i) – (v) is clear from the preceding discussion. Suppose now that $a, b, c \in \mathbb{N}$. If $a = 1$, then $a = b = 1$, and $K_{1,c-1}$ realizes (a, b, c) . Suppose now that $a \geq 2$ and that a, b, c satisfy conditions (i) – (v). (Note that this implies that $\frac{1}{2}(2c - b - 3a + 2) \geq 1$.) Consider the tree $T(n, m, \ell, t)$ in Figure 5.7. Then, the tree T described below realizes the triple (a, b, c) as $(\gamma(T), \gamma_t(T), p(T))$.

- If $a = b$, let $T = T(c - 2a + 1, a, 0, 0)$.
- If $b = c - 2$ (and, hence, $a = \lceil \frac{c}{3} \rceil$), let $T = T(0, 0, \lfloor \frac{c}{3} \rfloor, c - 3 \lfloor \frac{c}{3} \rfloor) \cong P_c$.
- If $a = \frac{c}{2}$ (and, hence, $b = \frac{c}{2}$), let $T = T(1, \frac{c}{2}, 0, 0) \cong P_a \circ K_1$.
- If $b = 3a - 2$, let $T = T(0, 0, a, 0) \cong P_{3a}$.

Otherwise, if $b - a \geq 1$ is odd (so that $3a - 2 - b$ is odd and $2c - b - 3a + 3$ is even), let $T = T(\frac{1}{2}(2c - b - 3a + 3), \frac{1}{2}(3a - b - 3), \frac{1}{2}(b - a + 1), 1)$, and, if $b - a \geq 2$ is even (so that $3a - 2 - b$ is even and $2c - b - 3a + 2$ is even), let $T = T(\frac{1}{2}(2c - b - 3a + 2), \frac{1}{2}(3a - b - 2), \frac{1}{2}(b - a), 2)$. \square

Finally, we characterize the triples (a, b, c) for which there exists a connected graph G with $(\gamma(G), \gamma_t(G), p(G)) = (a, b, c)$. First, we make the following simple observation.

Observation. If G is a connected graph of order $p \geq 3$, then $\gamma_t(G) = \frac{2p}{3}$ implies $\gamma(G) = \frac{p}{3}$.

Proof. If G is a connected graph of order $p \geq 3$ for which $\gamma_t(G) = \frac{2p}{3}$, then $\gamma(G) + \gamma_t(G) \leq p$ (see Theorem 5.1.28) implies $\gamma(G) \leq p - \frac{2p}{3} = \frac{p}{3}$, while $2\gamma(G) \geq \gamma_t(G) = \frac{2p}{3}$ implies $\gamma(G) \geq \frac{p}{3}$. \square

Theorem 5.2.11. *Given $a, b, c \in \mathbb{N}$, there exists a non-trivial, connected graph G with $(\gamma(G), \gamma_t(G), p(G)) = (a, b, c)$ if and only if $(a, b, c) = (1, 2, c)$ or*

- (i) $2 \leq a \leq b \leq 2a$,

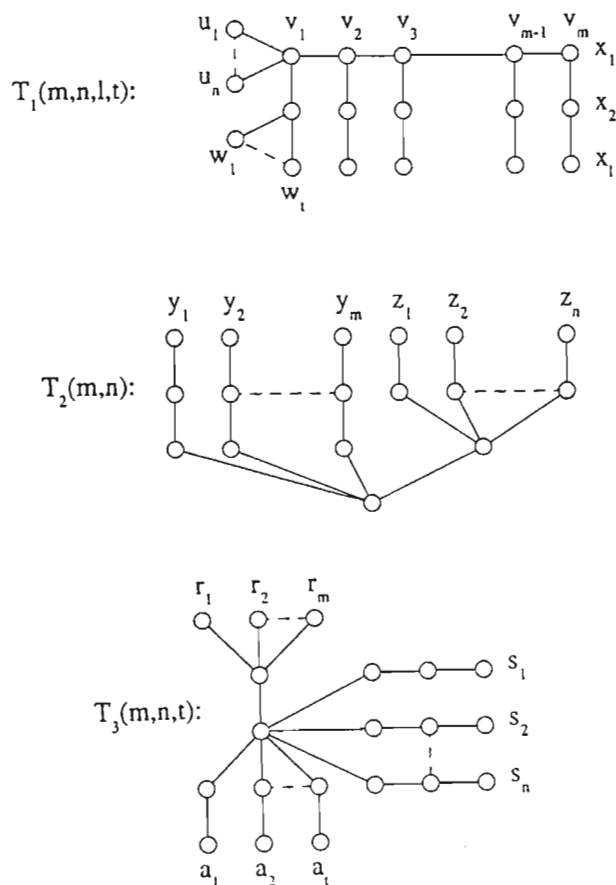

Figure 5.8: The trees $T_1(m, n, \ell, t)$, $T_2(m, n)$ and $T_3(m, n, t)$

(iii) $a + b \leq c$,

(iv) $a \leq \frac{c}{2}$,

(v) $b < \frac{2c}{3}$, or $b = \frac{2c}{3}$ and $a = \frac{c}{3}$.

In fact, if conditions (i) – (v) are satisfied, the graph G can always be required to be a tree.

Proof. The necessity of the conditions (i) – (v) is clear from our preceding discussions. Let $a, b, c \in \mathbb{N}$. If $a = 1$ (so that $b = 2$), the star $K_{1,c-1}$ realizes (a, b, c) . Suppose now that a, b, c satisfy conditions (i) – (v) (then $c \geq 4$). We consider several cases; in doing so, we refer to the trees $T_1(m, n, \ell, t)$, $T_2(m, n)$ and $T_3(m, n, t)$ in Figure 5.8.

Case 1: Suppose $a = b$. Then the tree $T = T_1(a, c-2a, 1, 0)$ has $(\gamma(T), \gamma_t(T), p(T)) = (a, b, c)$.

Case 2: Suppose $b = 2a$ (so that $c \geq 3a$). Then the tree $T = T_1(a, 0, 2, c - 3a + 1)$ has $(\gamma(T), \gamma_t(T), p(T)) = (a, b, c)$. (Notice that this case includes the situation $b = 2a$ and $c = a + b$.)

Case 3: Suppose $a + b = c$, $a \leq b \leq 2a - 1$, $b < \frac{2c}{3}$. Then the tree $T = T_2(b - a, 2a - b - 1)$ realizes (a, b, c) .

Case 4: Suppose $b = \frac{2c}{3}$. Then $a = \frac{c}{3}$ and $T = T_1(a, 0, 3, 1)$ has $(\gamma(T), \gamma_t(T), p(T)) = (a, b, c)$.

Case 5: Suppose $2 \leq a < b < 2a$, $a + b < c$, $a < \frac{c}{2}$, $b < \frac{2c}{3}$. Then the tree $T = T_3(c - a - b + 1, b - a - 1, 2a - b)$ realizes (a, b, c) . \square

5.3 Characterizing the realizable triples $(\gamma, \gamma_t, \gamma_c)$

In this final section, we present a theorem which gives necessary conditions on $\gamma(G)$, $\gamma_t(G)$, and $\gamma_c(G)$ for a connected graph G . Notice that, if $p(G) \geq 2$ for a connected graph G , then $\gamma(G) = 1$ implies that $\gamma_t(G) = 2 = \gamma_c(G)$. While result (iii) follows easily from our proof, recall that it was also proved by Duchet and Meyniel in [DM82].

Theorem 5.3.1. *For any connected graph G ,*

$$(i) \quad \gamma(G) \geq 2 \text{ implies } \gamma(G) \leq \gamma_t(G) \leq \gamma_c(G),$$

$$(ii) \quad \gamma_t(G) \leq 2\gamma(G),$$

$$(iii) \quad \gamma_c(G) \leq 3\gamma(G) - 2, \text{ and}$$

$$(iv) \quad \gamma_c(G) \leq \begin{cases} 2\gamma_t(G) - 2 & \text{if } \gamma_t(G) \text{ is even,} \\ 2\gamma_t(G) - 3 & \text{if } \gamma_t(G) \text{ is odd.} \end{cases}$$

Proof. Let G be a connected graph. That (i) holds is obvious. Result (ii) holds since, if D is any minimum dominating set of G , then we can construct a total dominating set D_t of G as follows: For each vertex $v \in D$, let u_v denote an arbitrary, but fixed, neighbour of v in G . Then let $D_t = D \cup \{u_v; v \in D\}$.

Finally, we prove (iii) and (iv). Let $\emptyset \neq D \subseteq V(G)$, and let $H = \langle D \rangle_G$. Recall that $k(F)$ denotes the number of components of a graph F . Let the components of H be H_1, H_2, \dots, H_t . If D is a minimum dominating set of G , then $t \leq \gamma(G)$, and if D is

a minimum total dominating set of G , then $t \leq \lfloor \frac{1}{2}|D| \rfloor$. Now, for $i \in \{1, 2, \dots, k\}$, let P be a shortest path connecting a vertex in $V(H_i)$ to a vertex in $D_t - V(H_i)$: Say, $P : x_1, x_2, \dots, x_\ell$ ($\ell \geq 3$) with $x_1 \in H_i$, $x_\ell \in H_j$, $i \neq j$. Suppose $\ell > 4$. By the definition of P , $x_3 \notin D$; x_3 is adjacent, of course, to some $h \in H_m$ ($m \in \{1, 2, \dots, t\}$). So, $P' : x_1, x_2, x_3, h$ is shorter than P , and hence P' does not join a vertex in $V(H_i)$ to a vertex in $D_t - V(H_i)$. Thus, $m = i$. However, then $h, x_3, x_4, \dots, x_\ell$ is shorter than P and joins a vertex h in $V(H_i)$ to a vertex $x_\ell \in V(H_j)$, $j \neq i$, a contradiction. So, $\ell \leq 4$ and adding $\{x_2\}$ or $\{x_2, x_3\}$ to D yields a set D' with $k(\langle D' \rangle_G) = t - 1$. So, recalling that H_i is an arbitrary component of $\langle D_t \rangle$, we see that adding at most $2(t - 1)$ vertices to D , we obtain a connected dominating set D_c of G . Hence, if D is a minimum dominating set of G then

$$\gamma_c(G) \leq |D_c| \leq |D| + 2(t - 1) = \gamma(G) + 2t - 2 \leq 3\gamma(G) - 2.$$

If D is a minimum total dominating set and $\gamma_t = 2\ell_e$ or $2\ell_o + 1$ ($\ell_e, \ell_o \in \mathbb{N}$), then

$$\gamma_c(G) \leq |D_c^t| \leq |D_t| + 2(t - 1) = \begin{cases} 2\ell_o + 2t - 1 \leq 4\ell_o - 1 = 2\gamma_t(G) - 3 & \text{if } \gamma_t(G) \text{ is odd,} \\ 2\ell_e + 2t - 2 \leq 4\ell_e - 2 = 2\gamma_t(G) - 2 & \text{if } \gamma_t(G) \text{ is even.} \end{cases}$$

□

We now show that the conditions (i) to (iv) are not only necessary but sufficient as well; in fact, given $\gamma, \gamma_t, \gamma_c$ satisfying (1) – (4) below, we show that not only is there a graph G with $\gamma(G) = \gamma$, $\gamma_t(G) = \gamma_t$, and $\gamma_c(G) = \gamma_c$, but that we can always find such a graph that is a tree.

Theorem 5.3.2. *Given integers a, b, c with*

$$(1) \ 2 \leq a \leq b \leq c,$$

$$(2) \ b \leq 2a,$$

$$(3) \ c \leq 3a - 2, \text{ and}$$

$$(4) \ c \leq \begin{cases} 2b - 2 & \text{if } b \text{ is even} \\ 2b - 3 & \text{if } b \text{ is odd} \end{cases},$$

there exists a tree T with $\gamma(T) = a$, $\gamma_t(T) = b$, and $\gamma_c(T) = c$.

Proof. We proceed by induction on a . Since the possible triples $(\gamma(T), \gamma_t(T), \gamma_c(T))$ for a graph T when $\gamma(T) = 2$ are $(2, 2, 2)$, $(2, 3, 3)$ and $(2, 4, 4)$, which are realized by P_4 , P_5 , and P_6 , respectively, it follows that the desired result holds for $a = 2$. Suppose there exists $a \in \mathbb{N}$, $a \geq 3$, such that, for every $b', c' \in \mathbb{N}$ satisfying

- $2 \leq a - 1 \leq b' \leq c'$,
- $b' \leq 2(a - 1)$,
- $c' \leq 3(a - 1) - 2$,
- $c' \leq \begin{cases} 2b' - 2 & \text{if } b' \text{ is even} \\ 2b' - 3 & \text{if } b' \text{ is odd} \end{cases}$,

there exists a tree T' such that $\gamma(T') = a - 1$, $\gamma_t(T') = b'$, and $\gamma_c(T') = c'$. Now, let $b, c \in \mathbf{N}$ such that (1) – (4) are satisfied. We show that there exists a tree T with $\gamma(T) = a$, $\gamma_t(T) = b$, and $\gamma_c(T) = c$.

We begin by letting $a'' = a - 1$, $b'' = b - 2$, and $c'' = c - 3$. Then

- (i) $a'' \leq b'' \Leftrightarrow a - 1 \leq b - 2 \Leftrightarrow a \leq b - 1$,
- (ii) $b'' \leq c'' \Leftrightarrow b - 2 \leq c - 3 \Leftrightarrow b \leq c - 1$,
- (iii) $b'' \leq 2a'' \Leftrightarrow b - 2 \leq 2a - 2 \Leftrightarrow b \leq 2a$,
- (iv) $c'' \leq 3a'' - 2 \Leftrightarrow c - 3 \leq 3a - 3 - 2 \Leftrightarrow c \leq 3a - 2$, and
- (v) $\begin{cases} c'' \leq 2b'' - 2 \Leftrightarrow c - 3 \leq 2b - 4 - 2 \Leftrightarrow c \leq 2b - 3 & \text{if } b'' \equiv b \equiv 0 \pmod{2} \\ c'' \leq 2b'' - 3 \Leftrightarrow c - 3 \leq 2b - 4 - 3 \Leftrightarrow c \leq 2b - 4 & \text{if } b'' \equiv b \equiv 1 \pmod{2}. \end{cases}$

So, the following conditions hold:

- (i') $a'' \leq b''$ (and $a \leq b - 1$) or $b = a$,
- (ii') $b'' \leq c''$ (and $b \leq c - 1$) or $c = b$,
- (iii') $b'' \leq 2a''$,
- (iv') $c'' \leq 3a'' - 2$ (and $c \leq 3a - 2$),
- (v') $\begin{cases} c'' \leq 2b'' - 2 & \text{(and } c \leq 2b - 3) \text{ or } c = 2b - 2 \text{ if } b'' \equiv b \equiv 0 \pmod{2} \\ c'' \leq 2b'' - 3 & \text{(and } c \leq 2b - 4) \text{ or } c = 2b - 3 \text{ if } b'' \equiv b \equiv 1 \pmod{2}. \end{cases}$

These yield the following eight cases.

Case	(i')	(ii')	(v'), b even	(v'), b odd
1	$a'' \leq b''$	$b'' \leq c''$	$c'' \leq 2b'' - 2$	$c'' \leq 2b'' - 3$
2	$a'' \leq b''$	$b'' \leq c''$	$c = 2b - 2$	$c = 2b - 3$
3	$a'' \leq b''$	$b = c$	$c'' \leq 2b'' - 2$	$c'' \leq 2b'' - 3$
4	$a = b$	$b'' \leq c''$	$c'' \leq 2b'' - 2$	$c'' \leq 2b'' - 3$
5	$a'' \leq b''$	$b = c$	$c = 2b - 2$	$c = 2b - 3$
6	$a = b$	$b = c$	$c'' \leq 2b'' - 2$	$c'' \leq 2b'' - 3$
7	$a = b$	$b'' \leq c''$	$c = 2b - 2$	$c = 2b - 3$
8	$a = b$	$b = c$	$c = 2b - 2$	$c = 2b - 3$

In other words, we have

Case	(i')	(ii')	(v'), b even	(v'), b odd
1	$a'' \leq b''$	$b'' \leq c''$	$c'' \leq 2b'' - 2$	$c'' \leq 2b'' - 3$
2	$b \geq a + 1$	$c \geq b + 1$	$c = 2b - 2$	$c = 2b - 3$
3	$b \geq a + 1$	$b = c$	$c \leq 2b - 3$	$c \leq 2b - 4$
4	$a = b$	$c \geq b + 1$	$c \leq 2b - 3$	$c \leq 2b - 4$
5	$b \geq a + 1$	$b = c$	$c = 2b - 2$	$c = 2b - 3$
6	$a = b$	$b = c$	$c \leq 2b - 3$	$c \leq 2b - 4$
7	$a = b$	$c \geq b + 1$	$c = 2b - 2$	$c = 2b - 3$
8	$a = b$	$b = c$	$c = 2b - 2$	$c = 2b - 3$

Now, since $3 \leq a \leq b$ holds, Case 5 cannot occur, whether b is even or odd, and Case 8 cannot occur if b is even; if b is odd, Case 8 reduces to the case $a = 3 = b = c$, which is realizable by the tree obtained by appending an end-vertex to every vertex of a copy of P_3 . We consider the remaining six cases as follows:

Case 1: Suppose $2 \leq a'' \leq b'' \leq c''$ and $c'' \leq \begin{cases} 2b'' - 2 & \text{if } b'' \text{ is even} \\ 2b'' - 3 & \text{if } b'' \text{ is odd.} \end{cases}$

Then (since (c') and (d') hold), it follows by our inductive hypothesis that there exists a (non-trivial) tree T'' with $\gamma(T'') = a''$, $\gamma_t(T'') = b''$, and $\gamma_c(T'') = c''$. Then, if v is a vertex of T'' that is a neighbour of an end-vertex of T'' , the identification of v with the end-vertex of a copy of P_5 yields a tree T with $\gamma(T) = \gamma(T'') + 1 = a$, $\gamma_t(T) = \gamma_t(T'') + 2 = b$, $\gamma_c(T) = \gamma_c(T'') + 3 = c$.

Case 2: Suppose $a + 1 \leq b$, $b + 1 \leq c$ and $c = \begin{cases} 2b - 2 & \text{if } b \text{ is even} \\ 2b - 3 & \text{if } b \text{ is odd.} \end{cases}$

(So, $b \geq 4$.) Then, if $a = 3$, we have $(a, b, c) = (3, 4, 6)$ or $(a, b, c) = (3, 5, 7)$; the

former is realized by the path P_8 and the latter by P_9 . Suppose now that $a \geq 4$. If $c = b + i$, where i is odd, then the third condition above implies that $b = 2 + i$ if b is even, and $b = 3 + i$ if b is odd, which is absurd. So, $c \geq b + 2$ and b, c have the same parity. Suppose $b \geq a + 2$. In Figure 5.9, k and ℓ are positive integers. If a is even and b is odd, then, since $a = 4$ implies $b = 8$ and $c = 11$, whereas $c \leq 3a - 2$ implies $c \leq 10$, we must have $(a, b, c) = (6, 9, 15)$, which is realizable by the path P_{17} , or $a \geq 8$ and the tree $T_{1.1}$ in Figure 5.9 with $\ell = \frac{1}{2}(b - a - 1)$ and $k = \frac{1}{2}(3a - 2b)$ has $(\gamma(T_{1.1}), \gamma_t(T_{1.1}), \gamma_c(T_{1.1})) = (a, b, c)$. If a is even and b is even, then, since $a = 4$ implies $b = 8$ and $c = 14$, whereas $c \leq 3a - 2$ implies $c \leq 10$, we must have $(a, b, c) = (4, 6, 10)$, which is realized by the path P_{12} , or $a \geq 6$ and the tree $T_{1.2}$ in Figure 5.9 with $\ell = \frac{1}{2}(b - a)$ and $k = \frac{1}{2}(3a - 2b)$ has $(\gamma(T_{1.2}), \gamma_t(T_{1.2}), \gamma_c(T_{1.2})) = (a, b, c)$. If a is odd and b is odd, then either $(a, b, c) = (3, 5, 7)$, which is realizable by P_9 , or $a \geq 7$ and the tree $T_{1.3}$ in Figure 5.9 with $\ell = \frac{1}{2}(b - a)$ and $k = \frac{1}{2}(3a - 2b - 1)$ has $(\gamma(T_{1.3}), \gamma_t(T_{1.3}), \gamma_c(T_{1.3})) = (a, b, c)$. If a is odd and b is even, then $a \geq 7$ and the tree $T_{1.4}$ in Figure 5.9 $\ell = \frac{1}{2}(b - a)$ and $k = \frac{1}{2}(3a - 2b)$ has $(\gamma(T_{1.4}), \gamma_t(T_{1.4}), \gamma_c(T_{1.4})) = (a, b, c)$. If $b = a + 1$ and a is even, then $c = 2(a + 1) - 3 = 2a - 1$, and the tree T_2 in Figure 5.9 has $\gamma(T_2) = a$, $\gamma_t(T_2) = b$, $\gamma_c(T_2) = c$. If $b = a + 1$ and a is odd, then $c = 2a$, and the tree T_3 in Figure 5.9 has $\gamma(T_3) = a$, $\gamma_t(T_3) = a + 1$, $\gamma_c(T_3) = 2a$.

Case 3: Suppose $a + 1 \leq b = c$ and $c \leq \begin{cases} 2b - 3 & \text{if } b \text{ is even} \\ 2b - 4 & \text{if } b \text{ is odd.} \end{cases}$

Then $b \geq 4$. If $b = 2a$, then the tree T_1 in Figure 5.10 has $\gamma(T_1) = a$, $\gamma_t(T_1) = 2a$, and $\gamma_c(T_1) = 2a$. Otherwise, the tree T_2 in Figure 5.10 has $\gamma(T_2) = a$, $\gamma_t(T_2) = b$, and $\gamma_c(T_2) = c$.

Case 4: Suppose $b = a$, $b + 1 \leq c \leq \begin{cases} 2b - 3 & \text{if } b \text{ is even} \\ 2b - 4 & \text{if } b \text{ is odd.} \end{cases}$

Then $a \geq 4$ and, in Figure 5.11, the tree T_1 has $\gamma(T_1) = a$, $\gamma_t(T_1) = b$, $\gamma_c(T_1) = c$ for the case $c - a \equiv 1 \pmod{2}$, and the tree T_2 has $\gamma(T_2) = a$, $\gamma_t(T_2) = b$, $\gamma_c(T_2) = c$, otherwise.

Case 6: Suppose $a = b = c$. Then $a \geq 4$ and the tree T obtained by appending an end-vertex to each vertex of a copy of P_a has $\gamma(T) = a$, $\gamma_t(T) = b$, $\gamma_c(T) = c$.

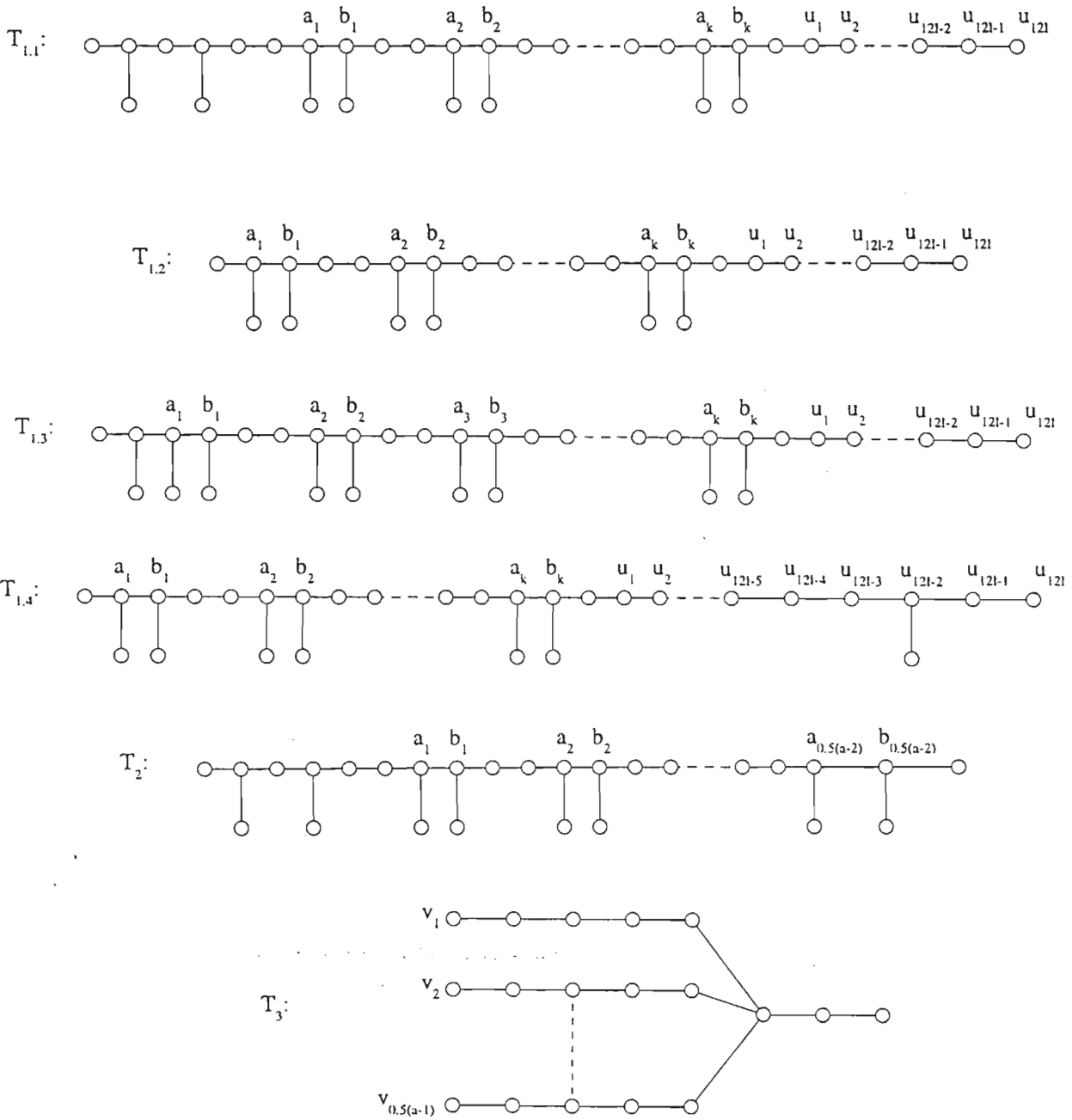

Figure 5.9: The graphs for Case 2

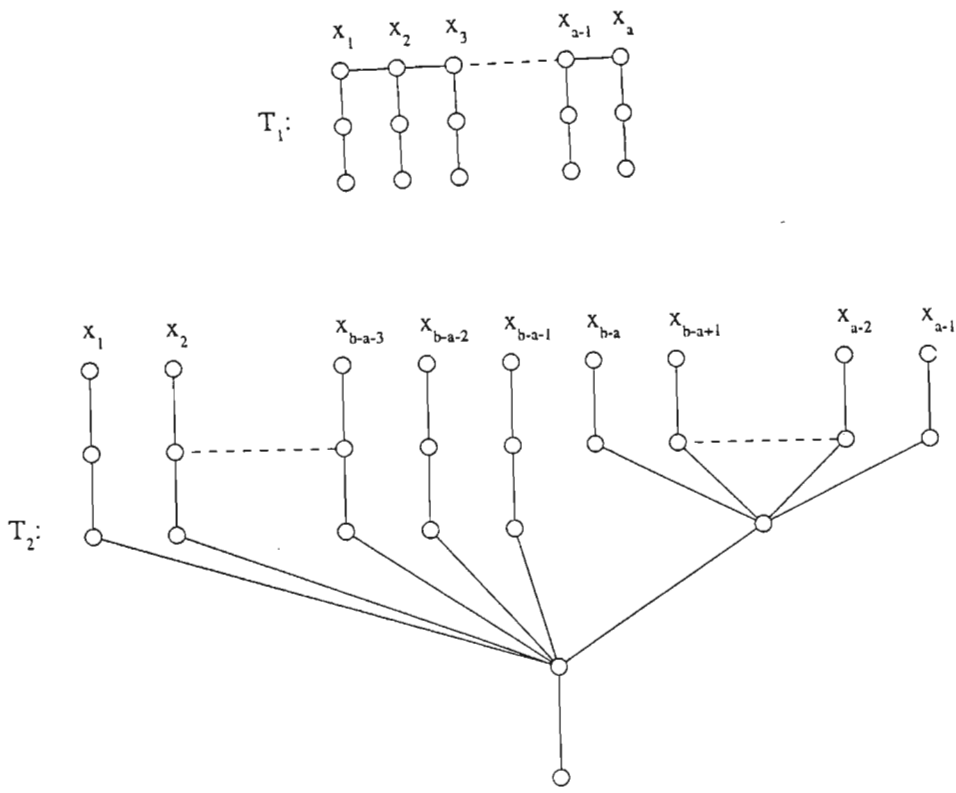

Figure 5.10: The graphs for Case 3

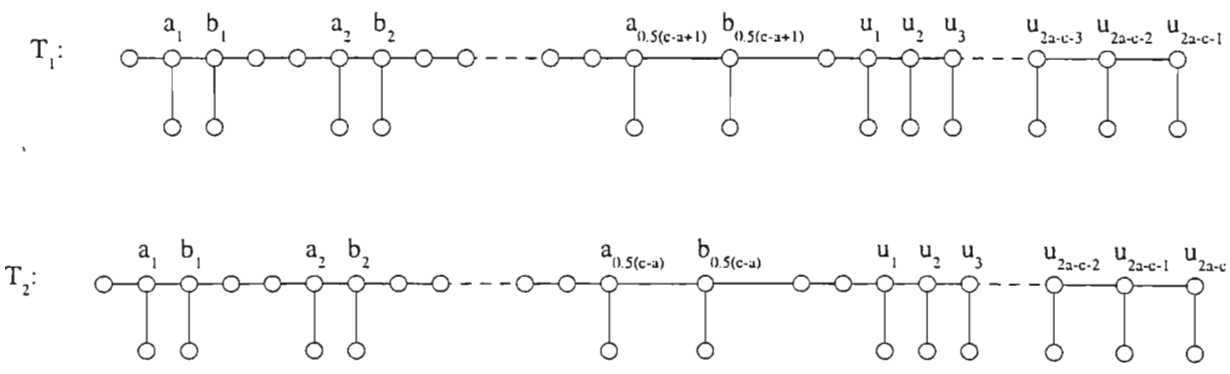

Figure 5.11: The graphs for Case 4

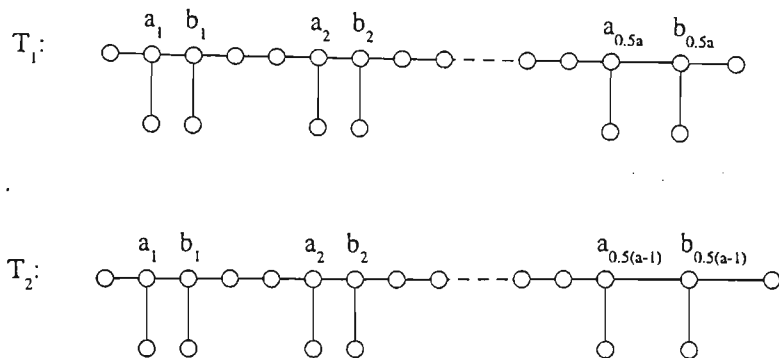

Figure 5.12: The graphs for Case 7

Case 7: Suppose $b = a$ and $b + 1 \leq c = \begin{cases} 2b - 2 & \text{if } b \text{ is even} \\ 2b - 3 & \text{if } b \text{ is odd.} \end{cases}$
 Then the trees T_1 and T_2 in Figure 5.12 realize a, b, c , respectively. □

Bibliography

- [AL78] R. B. Allan and R. Laskar, *On domination and independent numbers of a graph*, Discrete Math. (1978), no. 23, 73–76.
- [ALH84] R. B. Allan, R. Laskar, and S. T. Hedetniemi, *A note on total domination*, Discrete Math. (1984), no. 49, 7–13.
- [BC79] B. Bollobás and E. J. Cockayne, *Graph-theoretic parameters concerning domination, independence, and irredundance*, J. Graph Theory (1979), no. 3, 241–249.
- [BCD84] Robert C. Brigham, Phyllis Z. Chinn, and Ronald D. Dutton, *A study of vertex domination critical graphs*, Tech. Report M-2, Department of Mathematics, University of Central Florida, 1984.
- [BCD88] Robert C. Brigham, Phyllis Z. Chinn, and Ronald D. Dutton, *A study of vertex domination critical graphs*, Networks (1988), no. 18, 173–179.
- [Ber62] C. Berge, *Theory of graphs and its applications*, Methuen, London, 1962.
- [Ber73] C. Berge, *Graphs and Hypergraphs*, North Holland, Amsterdam, 1973.
- [BH90] Fred Buckley and Frank Harary, *Distance in Graphs*, Addison-Wesley, 1990.
- [BHJ91] C. Barefoot, F. Harary, and K. F. Jones, *What is the difference between the dominaton and independent domination numbers of a cubic graph?*, Graphs Combin. (1991), no. 7, 205–208.
- [BHNS83] Douglas Bauer, Frank Harary, Juhani Nieminen, and Charles L. Suffel, *Domination alteration sets in graphs*, J. Graph Theory (1983), no. 47, 153–161.
- [CDH80] E. J. Cockayne, R. M. Dawes, and S. T. Hedetniemi, *Total domination in graphs*, Networks (1980), no. 10, 211–219.

- [CFPT81] E. J. Cockayne, O. Favaron, C. Payan, and A. G. Thomason, *Contributions to the theory of domination, independence, and irredundance in graphs*, Discrete Math. (1981), no. 33, 249–258.
- [CH75] E. J. Cockayne and S. T. Hedetniemi, *Optimal domination in graphs*, IEEE Trans. Circuits and Systems (1975), no. 22, 855–857.
- [CH76] E. J. Cockayne and S. T. Hedetniemi, *Disjoint independent dominating sets in graphs*, Discrete Math. (1976), no. 15, 213–222.
- [CH77] E. J. Cockayne and S. T. Hedetniemi, *Towards a theory of domination in graphs*, Networks (1977), no. 7, 247–261.
- [CHM78] E. J. Cockayne, S. T. Hedetniemi, and D. J. Miller, *Properties of hereditary hypergraphs and middle graphs*, Canad. Math. Bull. (1978), no. 21, 461–468.
- [CL86] Gary Chartrand and Linda Lesniak, *Graphs and Digraphs*, second ed., Wadsworth and Brooks/Cole, Monterey, CA, 1986.
- [CM93] E. J. Cockayne and C. M. Mynhardt, *The sequence of upper and lower domination, independence and irredundance numbers of a graph*, Discrete Math. (1993), no. 122, 89–102.
- [Coc78] E. J. Cockayne, *Domination in undirected graphs - a survey*, Theory and Applications of Graphs in America's bicentennial year (Y. Alavi and D. R. Lick, eds.), Springer (Berlin), 1978, pp. 141–147.
- [CS93] V. Chvátal and P. J. Slater, *A note on well-covered graphs*, Ann. of Discrete Math. (1993), no. 55, 179–182.
- [dJ] C. F. de Jaenisch, *Applications de l'analyse mathématique au jeu des échecs*, Petrograd, 1862.
- [DM82] P. Duchet and H. Meyniel, *On Hadwiger's number and stability number*, Ann. of Discrete Math. (1982), no. 13, 71–74.
- [Erw95] David J. Erwin, *Parameters related to fractional domination in graphs*, Master's thesis, Univ. of Natal, Durban, 1995.
- [Faj88] Siemion Fajtlowicz, *A characterization of radius-critical graphs*, J. Graph Theory (1988), no. 12, 529–532.

- [FJKR85] J. F. Fink, M. S. Jacobson, L. F. Kinch, and J. Roberts, *On graphs having domination number half their order*, Periodica Mathematica Hungarica (1985), no. 16, 287–293.
- [FJKR91] John Frederick Fink, Michael S. Jacobson, Lael F. Kinch, and John Roberts, *The bondage number of a graph*, Topics on Domination (New York), North-Holland, New York, 1991, pp. 47–58.
- [FV90] Peter Flach and Lutz Volkmann, *Estimations for the domination number of a graph*, Discrete Math. (1990), no. 80, 145–151.
- [Gal59] T. Gallai, *Über extreme Punkt-und Kantenmengen*, Ann. Univ. Sci. Budapest, Eötvös Sect. Math. (1959), no. 2, 133–138.
- [GJ84] M. R. Garey and D. S. Johnson, *Computers and Intractability*, W. H. Freeman, San Francisco, 1984.
- [GV] J. Gimbel and P. D. Vestergaard, *Inequalities for total matchings of graphs*, to appear.
- [Hen] M. A. Henning, *Domination in graphs: A survey*, preprint.
- [HL84] S. T. Hedetniemi and Renu Laskar, *Connected domination in graphs*, Graph theory and combinatorics (B. Bollobás, ed.), Academic Press (London), 1984, pp. 209–218.
- [HL90] S. T. Hedetniemi and R. C. Laskar, *Bibliography on domination in graphs and some basic definitions of domination parameters*, Discrete Math. (1990), no. 86, 257–277.
- [HL91] S. T. Hedetniemi and R. C. Laskar (eds.), *Topics on domination*, Ann. of Discrete Math., North-Holland, 1991.
- [HLP85] S. T. Hedetniemi, R. Laskar, and J. Pfaff, *Irredundance in graphs: a survey*, Congr. Numer. (1985), no. 48, 183–193.
- [HOS91] M. A. Henning, Ortrud R. Oellermann, and Henda C. Swart, *Bounds on distance domination parameters*, J. Combin. Inform. System Sci. (1991), no. 16, 11–18.
- [HR94] Bert L. Hartnell and Douglas F. Rall, *Bounds on the bondage number of a graph*, Discrete Math. (1994), no. 128, 173–177.

- [HSa] T. W. Haynes and P. J. Slater, *Paired-domination and the paired-domestic number*, to appear.
- [HSb] T. W. Haynes and P. J. Slater, *Paired-domination in graphs*, to appear.
- [JA] J. Paulraj Joseph and S. Arumugam, *A note on domination in graphs*, preprint.
- [JP72] F. Jaeger and C. Payan, *Relations de type Nordhaus-Gaddum pour le nombre d'absorption d'un graphe simple*, C. R. Acad. Sci. Paris Ser. A (1972), no. 274, 728–730.
- [KM86] M. S. Krishnamoorthy and Kowtha Murthy, *On the total dominating set problem*, Congr. Numer. (1986), no. 54, 265–278.
- [KSH71] J. G. Kalbfleisch, R. G. Stanton, and J. D. Horton, *On covering sets and error-correcting codes*, J. Comb. Theory Ser. A (1971), no. 11, 233–250.
- [Liu68] C. L. Liu, *Introduction to Combinatorial Mathematics*, McGraw-Hill, New York, 1968.
- [LW80] Renu Laskar and H. B. Walikar, *On domination related concepts in graph theory*, Combinatorics and graph theory, Lecture Notes in Math., no. 885, Springer (Berlin), 1980, pp. 308–320.
- [Mar85] Dănut Marcu, *Domination number of a graph*, Quart. J. Math. Oxford (2) (1985), no. 36, 221–223.
- [MH77] S. M. Mitchell and S. T. Hedetniemi, *Edge domination in trees*, Proceedings of the Eighth S. E. Conference on Combinatorics, Graph Theory and Computing (Winnipeg), Utilitas Mathematica, 1977, pp. 489–509.
- [MM66] J.W Moon and L. Moser, *Relationships between integer and fractional parameters of graphs*, Studia Sci. Math. Hungar. (1966), 153–156.
- [MM75] A. Meir and J.W. Moon, *Relations between packing and covering numbers of a tree*, Pacific J. Math. (1975), no. 61, 225–233.
- [MS89] William McCuaig and Bruce Shepherd, *Domination in graphs with minimum degree two*, J. Graph Theory (1989), no. 13, 749–762.
- [Myn91] C. M. Mynhardt, *On the difference between the domination and independent domination number of cubic graphs*, Graph theory, Combinatorics, and Applications (1991), no. 2, 939–947.

- [Nie74] J. Nieminen, *Two bounds for the domination number of a graph*, Inst. Maths. Applics. (1974), no. 14, 183–187.
- [NWDB88] Newman-Wolfe, Ronald D. Dutton, and Robert C. Brigham, *Connecting sets in graphs*, Congr. Numer. (1988), no. 67, 67–76.
- [Ore62] O. Ore, *Theory of graphs*, Amer. Math. Soc. Transl., Providence, R.I., 1962.
- [Pay75] C. Payan, *Sur le nombre d'absorption d'un graphe simple*, Cahier Centre Études Recherche Oper. (1975), no. 17, 307–317.
- [PES86] M. Saks P. Erdős and V. Sós, *Maximum induced trees in graphs*, J. Combinat. Theory Ser. B (1986), no. 41, 61–69.
- [PLH83] J. Pfaff, R. Laskar, and S. T. Hedetniemi, *NP-completeness of total and connected domination and irredundance for bipartite graphs*, Tech. Report 428, Clemson University, 1983.
- [PX82] C. Payan and N. H. Xuong, *Domination-balanced graphs*, J. Graph Theory (1982), no. 6, 23–32.
- [San91] L. A. Sanchis, *Maximum number of edges in connected graphs with a given domination number*, Discrete Math. (1991), no. 87, 64–72.
- [Sin68] R. R. Singleton, *There is no irregular Moore graph*, Amer. Math. Monthly (1968), no. 7, 42–43.
- [SM79] D. P. Sumner and J. L. Moore, *Domination perfect graphs*, Notices Amer. Math. Soc. (1979), no. 26, A–569.
- [Smi92] Vivienne Smithdorf, *On the integrity of domination in graphs*, Master's thesis, Univ. of Natal, Durban, 1992.
- [SW79] E. Sampathkumar and H. B. Walikar, *The connected domination number of a graph*, Math. Phys. Sci. (1979), no. 13, 607–613.
- [Viz65] V. G. Vizing, *A bound on the external stability number of a graph*, Doklady A. N. (1965), no. 164, 729–731.
- [Vol88] L. Volkmann, *Minimale und unabhängige minimale Überdeckungen*, An. Univ. Bucureş Mat. (1988), no. 37, 85–90.

- [Vol90] L. Volkmann, Simple reduction theorems for finding minimum coverings and minimum dominating sets, 667–672, Bibliographisches Institut, Manneheim, 1990, pp. 667–672.
- [WAS] H. B. Walikar, B. D. Acharya, and E. Sampathkumar, *On an extremal problem concerning a Nordhaus-Gaddum type result in the theory of domination in graphs*, preprint.
- [WSA] H. B. Walikar, E. Sampathkumar, and D. Acharya, *Two new bounds for the domination number of a graph*, preprint.
- [WSA78] H. B. Walikar, E. Sampathkumar, and D. Acharya, *Recent developments in the theory of graphs and its applications*, MRI Lecture notes in Mathematics (1978), no. 1.