

**INFLUENCE OF
WAGON
STRUCTURE ON THE
VERTICAL
RESPONSE OF
FREIGHT**

By

Richard Clive Loubser M.Sc. (Eng) (Natal)

2002

Submitted in fulfilment of the academic requirements for the degree of Doctor of Philosophy, in the Department of Mechanical Engineering, University of Natal, Durban, South Africa.

DECLARATION

I hereby declare that this is my own work and has not been submitted for a degree at any other University

A handwritten signature in black ink, appearing to read 'R.C. Loubser', with a stylized flourish at the end.

R.C. Loubser

January 2002

ABSTRACT

Historically, wagons have been designed according to the American Association of Railroads specifications. These require that wagons be designed to withstand a static load between the couplers of 350 tons. This implies that the structure has a certain stiffness. In order to improve load to tare ratio, there has been talk of reducing the end load specifications. This implies that the stiffness of the wagon will reduce. Using more flexible wagons implies that the freight will probably be exposed to a harsher dynamic environment.

There is a trade off between the cost of packaging and the cost of protection devices installed in the vehicle. If handling damage can be prevented then an understanding of the dynamic environment will assist in reducing the packaging requirement.

This research looked at the dynamic characteristics of an existing design of wagon using modal analysis. The results from the modal analysis were extended to be inputs to the time domain freight model. Various analytical models of the freight were developed depending on the configuration and dynamic properties. Special consideration was given to a cylinder with its axis transverse to the wagon. The modal model was modified to accommodate the change in mass imposed by the freight.

The various sources of dynamic excitation were explored, namely inputs from the coupler and from the bogie. Data from shunting yard simulations were used to generate spectra as input to the wagon model.

The objective was to use modal techniques to be able to take individual components, form them into a complete model and make informed decisions about the suitability of a certain configuration for traffic.

PREFACE

When the author started work at the Spoornet Engineering Development Centre, $\epsilon\delta C$, a major focus was on the draw-gear. These devices were being studied for their ability to protect freight from damage. In 1991 the Computer Aided Rail Test and Development System, CARTADS, was commissioned at $\epsilon\delta C$.

CARTADS consisted of a network of micro VAX computers loaded with I-Deas (Integrated Design and engineering analysis software). This software allowed the development of finite element models and analysis of test data in the same integrated environment.

It was the request from a motor vehicle manufacturer and a paper manufacturer for frequency information that inspired this research.

A year after starting this research, the author was transferred to Johannesburg. Contact was kept with the CARTADS computer through a modem link. This allowed the finite element model to be constructed.

The author's successor kindly acquired the data from the modal tests onto a PC compatible CD. Attempts were made to process this data with Matlab. These attempts continued to a point where the author gratefully accepted the offer of the use of the "Star" modal analysis package that was at the Mechanical Engineering Department of Natal University.

The move from the research and development section ($\epsilon\delta C$) meant that the experimental data available were far less than was originally envisaged. The author, however, believes that the techniques investigated will provide an additional tool to improve the effectiveness and economics of freight damage prevention.

ACKNOWLEDGEMENTS

There are many people who have contributed to the research and the production of this thesis. I would like to thank them all for their interest, suggestions and assistance. In particular, I would like to thank my wife and family for their tolerance and support for the duration of this work. Thank you to Chris Dutton for his input in the initial stages and to Fanus van der Westhuizen and his team at the Spoornet engineering development centre (eδC) for assistance with the acquisition and preparation of data.

My appreciation also goes to my supervisors: Stefan Kaczmarczyk and Sarp Adali and my sister for their assistance in structuring and proofreading this thesis also to SMRI for allowing me time to complete this work.

The financial support offered by Spoornet buraries in the early stages of this research is also gratefully acknowledged.

CONTENTS

CHAPTER 1 OVERVIEW	1
1.1 Introduction.....	1
1.2 System Configuration and Analysis Strategy	2
1.3 Categories of Freight	4
1.4 Types of Mechanical Freight Damage	5
1.5 Causes of Freight Damage	6
1.5.1 Impact Initiated Damage	6
1.5.2 Train Handling.....	7
1.5.3 Atmospheric Environment.....	8
1.5.4 Vibrational Environment.....	8
1.6 Analysis Tools	8
1.6.1 Fragility Index.....	8
1.6.2 Modal Analysis.....	9
1.6.3 Dynamic Simulations	10
1.7 Problem Solving	10
1.7.1 Impact Analysis.....	10
1.7.2 Dynamic Analysis.....	11
1.8 Related Research	11
1.9 Objectives	13
CHAPTER 2 THE METHOD OF INVESTIGATION	15
2.1 Introduction.....	15

2.2 Experimental Approach	16
2.2.1 Wagon Modal Characteristics	16
2.2.2 Freight Parameters	17
2.3 Mathematical Modelling of Wagon Structure	18
2.3.1 Finite Element (FE)	18
2.4 Wagon Excitation Sources	18
2.4.1 Rail	18
2.4.2 Shunting Impact	19
2.5 Train Action	19
2.6 Mathematical Modelling of Freight	20
2.6.1 Time Domain	20
2.6.2 Frequency Domain	21
2.7 Quantification of the Strength of Freight	21
2.7.1 Drop Test	21
2.7.2 Fragility Index	22
2.8 Freight Response to Wagon Inputs	22
2.8.1 Frequency Matching	22
2.8.2 Magnitude of Input	23
CHAPTER 3 PACKAGING	24
3.1 Introduction	24
3.2 Design Considerations for Packaging	25
3.2.1 The Manufacturer's Perspective	25
3.2.2 The Carriage Point of View	25
3.2.3 Aspects of Interest to the Recipient	26
3.3 Testing of Packaging for Impact and Vibration Protection	27

3.3.1 Drop Test	27
3.3.2 Fragility Index.....	27
3.3.3 Shaker Simulations	28
3.3.4 Line Tests	29
3.4 Modelling - Differential Equations with Solvers.....	29
CHAPTER 4 MODAL ANALYSIS - A PROBLEM SOLVING TOOL	31
4.1 Introduction.....	31
4.2 Modal Behaviour and the State-Space Matrix.....	31
4.3 Frequency Response Functions	36
4.4 Spatial Response Functions.....	36
4.5 Modal Analysis Path.....	37
4.5.1 Experimental Approach.....	37
4.5.2 Finite Element Approach.....	39
4.5.3 Modal Assurance Criterion Matrix	40
4.5.4 Structural Modification	41
CHAPTER 5 FREIGHT - WAGON AS A DYNAMIC SYSTEM	42
5.1 Introduction.....	42
5.2 Sub-Systems.....	43
5.2.1 Draw-gear	43
5.2.2 Bogies and Suspension	44
5.2.3 Wagon.....	44
5.2.4 Freight.....	45
CHAPTER 6 FREIGHT DYNAMICS	48

6.1 Introduction.....	48
6.2 Cylinders	49
6.2.1 Horizontal Cylinders.....	49
6.2.2 Vertical Cylinder.....	53
6.3 Fatigue Response.....	55
6.4 Tie-Down Slackening	55
6.5 Failure Criteria	59
6.5.1 Sliding	59
6.5.2 Tie-Downs.....	59
CHAPTER 7 FREIGHT ISOLATION SYSTEMS.....	60
7.1 Introduction.....	60
7.2 Shock Absorbent Materials	61
7.3 Vehicle Properties	63
7.3.1 Draw-gear	63
7.3.2 Structure	67
7.4 Suspension	69
7.5 Freight protection devices.....	69
7.5.1 Custom designed cradles.....	69
7.5.2 Air springs.....	70
7.6 Freight Protection Compromise.....	72
CHAPTER 8 MODAL TESTING OF WAGON STRUCTURE.....	73
8.1 Introduction.....	73

8.2 Methods of Excitation	74
8.2.1 Drop	74
8.2.2 Hammer	74
8.2.3 Impact from second wagon	75
8.2.4 Shaker.....	75
8.3 Comparison of White and Pink Noise Excitation	76
8.4 Testing and Test Results	77
8.4.1 Experimental configuration.....	77
8.4.2 Results.....	79
8.5 Introduction of Freight	80
CHAPTER 9 ADDING FREIGHT TO THE WAGON MODEL	81
9.1 Introduction.....	81
9.2 Structural Modification	81
9.3 Freight as a Structural Modifier.....	82
9.4 Results from the Application of the Structural Modifier	83
9.4.1 Pure Mass.....	83
9.4.2 Tuned Damper	84
9.5 Comparison of mode frequencies.....	86
9.6 The Loaded Wagon	87
CHAPTER 10 FINITE ELEMENT SIMULATION OF WAGON MODE SHAPES.....	88
10.1 Introduction.....	88
10.2 Modelling Philosophy	88

10.3 System Resource Limitations	89
10.4 Boundary Conditions	89
10.5 Model Solution.....	89
10.5.1 Solid Body Modes.....	90
10.5.2 Flexible Modes.....	90
10.5.3 Bending Mode.....	91
10.6 Discussion of Results	92
CHAPTER 11 FREIGHT PROPERTIES AND FREIGHT DYNAMICS	93
11.1 Introduction.....	93
11.2 Dynamic Strength.....	94
11.2.1 Drop testing.....	94
11.2.2 Fragility index.....	95
11.3 Stiffness characteristics	95
11.3.1 Compression Test.....	96
11.3.2 Drop Test.....	98
11.4 Dynamic Model of a Horizontal Resilient Cylinder	99
11.4.1 Material Properties.....	99
11.4.2 Computer Model	99
11.4.3 Conclusion	101
CHAPTER 12 DRAW-GEAR INFLUENCE	102
12.1 Introduction.....	102
12.2 Test Description	102
12.2.1 Apparatus Description.....	102
12.2.2 Instrumentation	103

12.2.3 Data Analysis	103
12.3 Results	103
12.3.1 Time Domain Wave Forms	103
12.3.2 Frequency Domain Analysis	106
12.3.3 Relative Performance of Gears.....	107
CHAPTER 13 CONCLUSIONS AND RECOMMENDATIONS.....	109
13.1 Summary	109
13.2 Freight	110
13.3 Wagon	111
13.4 Draw-gear.....	111
13.5 Complete Dynamic System.....	112
13.6 Original Contributions	112
CHAPTER 14 FUTURE WORK	114
14.1 Horizontal to Vertical Transfer Function	114
14.2 Verification of Model using Operational Deflection Shapes	114
14.3 Speed, Frequency and Path of Freight Hysteresis Loops	114
14.4 Database and Extraction Software.....	115
14.5 Multi-body Freight Model.....	115
APPENDIX A FREQUENCY RESPONSE FUNCTIONS FOR UNLOADED WAGON	121
APPENDIX B EXPERIMENTAL MODAL RESULTS.....	127

- CONTENTS -

B.1 Unloaded Wagon.....	127
B.2 Mode Shapes Modified with Mass Added.....	131
B.3 Mode Shapes Modified with Tuned Damper.....	135
APPENDIX C FINITE ELEMENT RESULTS	139
APPENDIX D PROGRAMS FOR PRODUCING SPECTRA FOR MODAL ANALYSIS	142
D.1 Program 'BLOCKER'	142
D.2 Program 'MAKEFRFFILES'.....	146
D.3 UFF48Formatter	148
APPENDIX E MATLAB CODE FOR ANALYSING DRAW-GEARS.....	152
APPENDIX F CURVES PREPARED FOR PAPER ROLL PROPERTIES	154
APPENDIX G PROGRAM FOR ANALYSIS OF HORIZONTAL PAPER ROLL.....	156
G.1 CSL Program File.....	156
G.2 CMD Command File.....	159
APPENDIX H LIST OF EQUIPMENT.....	160
H.1 Modal Testing of Wagon.....	160
H.1.1 Accelerometers	160
H.1.2 Load Cell	160
H.1.3 Data Tape.....	160
H.1.4 Analogue to Digital	161

H.2 Impact Test	161
H.2.5 Coupler Force.....	161
H.2.6 Coupler Displacement.....	161
H.2.7 Amplifier	161
H.2.8 Data Tape.....	161

LIST OF SYMBOLS

Symbol	Meaning
λ	Complex natural frequency
ω	Frequency in rad/s
θ	Angel of rotation (radian)
τ	Torque
δ	Difference or increment
Δ	Change in
η	Efficiency
γ	Ratio of specific heats
$\Psi, [\Psi]$	Generalized modal matrix
$\underline{\lambda}, [\omega_n^2]$	Diagonal matrix of modal frequencies
μ_d	Dynamic co-efficient of friction
ω_n	Natural frequency
μ_s	Static co-efficient of friction
$[K_{sys}]$	Coupling stiffness matrix between freight and wagon
A	Dynamic matrix in spatial co-ordinates
a	Curve shape factor
A	Area
$B(\omega)$	Spectrum from bogie
c	Viscous damping co-efficient
C	Damping matrix
C	Constant
F	Force
$G(\omega)$	Spectrum from draw-gear
H	Horizontal force
$H(\omega)$	Transfer matrix of wagon
J	Moment of inertia
k	Stiffness co-efficient
K	Stiffness matrix
L	Length
M	Mass matrix
M, m	Mass
N	Normal force
P	Modal co-ordinate
R	Radius of cylinder

-LIST OF SYMBOLS-

Symbol	Meaning
t	Time
T	Tension
V	Volume
X	Spatial co-ordinate vector
x,y	Spatial co-ordinates
\dot{x}, \dot{y}	First time derivatives of x and y
Z	Mode shape co-efficient
Z	Mode shape vector

Chapter 1 OVERVIEW

1.1 Introduction

Some eighty percent of the rail infrastructure in Africa is in South Africa. With this large capital investment it is essential that all efforts be made to attract customers rail transport and to provide existing customers with maximum possible benefits. A customer of a transport company has several requirements. These include:

- the consignment must arrive at promised delivery time
- the freight must arrive at its destination undamaged
- the tariff must be competitive with those offered by other possible suppliers.

Some of these requirements can be addressed in the way that the transport company operates. They can work according to tight departure, route and arrival schedules. Resources such as internet based information systems can be used to keep customers informed about the progress in relocating their goods.

Technical solutions need to be found to satisfy other requirements that the customer may have. Knowledge of the conditions in transit are required to optimise the protection of the freight.

One of the cost components in moving articles from one point to another is the protective packaging required. A cost trade-off arises between the protection offered by the vehicle itself and the packaging materials used. This is particularly true of the unfinished and bulk goods where manufacturers are reluctant to spend additional money on material and labour before transferring their product to another location. The finished consumer goods industry has one problem in that the packaging is part of the presentation of the product, and damage to the packaging can reduce its

saleability. An optimisation process between the cost of the protection offered by the vehicle and the cost of the packaging requires a knowledge of the various factors that contribute to the damage of the freight.

One of the aspects that is of interest to the transporter is the minimisation of claims for losses. 'Progressive Railroading' (1994), had an article where it was suggested that the effectiveness of damage prevention should be measured as the ratio of revenue to claims. They quote a figure of \$2.00 per \$100 being an all time high that occurred in 1970. A more reasonable figure is that achieved in 1993 of 34c per \$100. Similar data were presented by Grover (1982). Although the actual freight damage is a measurable figure, the losses in image or reputation are far greater and immeasurable. Pierce (1970) describes how design of the packaging, such as, dispensing facilities for the product and protection of the product, affects the customer.

In the present research it will be shown that there is a relationship between the structure of the wagon and the potential damage which freight may experience in transit. Over protection of freight is expensive whereas under protection can have disastrous consequences. Mathematical models showed that damage is not solely limited to single events but may also result from vibration and the cumulative effect of smaller events repeated periodically.

1.2 System Configuration and Analysis Strategy

Figure 1.1 shows the typical configuration of a wagon with its freight. The freight may take any form from containers to cylinders or loose goods.

-OVERVIEW-

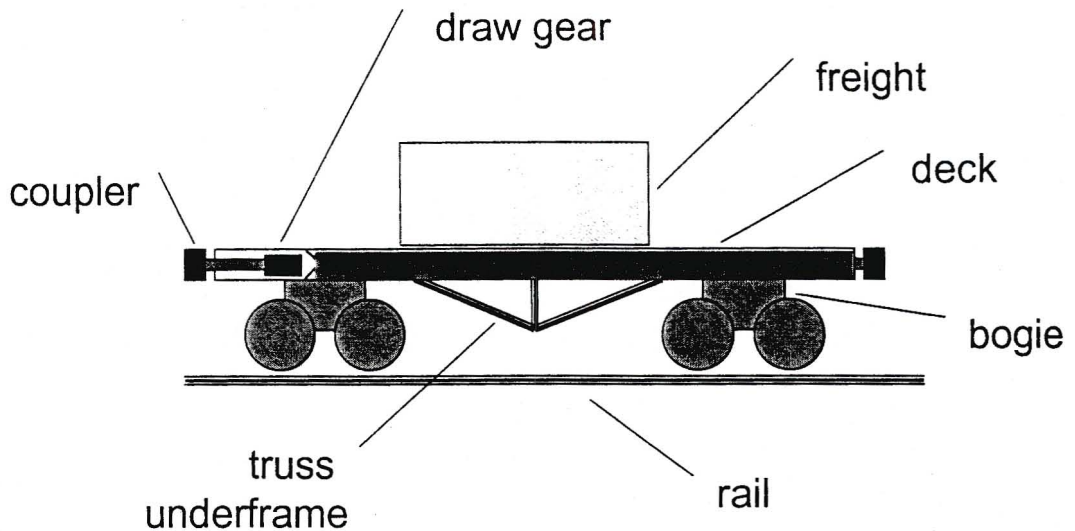

Figure 1.1 Typical wagon with its freight

The freight and the freight-deck interface were at the centre of the study. Traditional modal analysis techniques were used to analyse the motion of the deck. In other words, the wagon was analysed in the frequency domain. The freight, on the other hand is more difficult to analyse using linear techniques. For this reason, a time domain approach was used to visualize the motion of the freight. To take account of the dynamic interaction between the freight and the wagon, a linear representation of the freight properties was introduced into the modal model.

Dynamic input comes from train action, that is, interaction between the couplers of adjacent wagons. The forces are transferred to the deck through the draw-gear. The draw-gear determines the form of the force pulse that excites the deck. This was investigated with impact studies.

The track also acts as a source of input. Many researchers (eg. Dukkipati & Dong, 1999; Fröhling, Scheffel & Ebersöhn, 1995; Stichel, 1999) have already devoted a great of effort in the modelling of bogies albeit with special reference to the wheel-rail interface. Consequently, this area was considered to have received sufficient attention not to require expansion in this research.

1.3 Categories of Freight

The requirements for the protection of freight vary widely depending on the freight. Bulk raw materials require no protection and all efforts need be directed towards protecting the vehicle from fatigue damage. Commodities such as rough timber will not be damaged but the load may become unstable under high vibration and shock conditions. Semi-finished and finished goods may suffer surface damage, breakage or deformation if they are not adequately protected. These categories of freight can be described as follows:

- **Bulk Raw Materials:** Materials such as wood chips and ore are not subject to damage in transit. In this case, all efforts are directed towards protecting the vehicle structure from fatigue related failures rather than having to protect the freight from damage as well as the vehicle.
- **Stacked goods:** For the transport of certain goods such as rough cut timber for mining props it is convenient to make stacks that can be handled by forklift trucks. If these stacks move in transit, it can lead to their falling from the wagon. It is usually convenient to minimize the amount of securing materials necessary for a bulk load of this nature. Consequently, attention needs to be given to the features of the wagon itself.
- **Semi-Finished and Processed Materials:** Products such as paper and polished steel slab are produced by a manufacturer and transferred to another party for further processing. In this case, the requirement is that the minimum packaging is used to protect the goods but still deliver them in an undamaged condition. The degradation of the surface layer of the commodity needs to be minimised by avoiding the relative motion (abrasion) between

surfaces. The damage tends to be cumulative with the experience of more vibration cycles.

- **Vibration Sensitive Commodities:** Some items such as electro-mechanical instrumentation are sensitive to fatigue related failures, that is repetitive stresses from vibration inputs should be avoided. The fatigue effect of vibrations introduced by the vehicle's structural dynamics is greatest where the damped natural frequency, or resonant frequency, of the item matches that of the vehicle structure or suspension. This category of commodity does not experience failure as a result of a single shock event, but suffers fatigue damage as a result of cyclic loading, or stress reversals resulting from the vibrations experience en route.

The packaging itself may be sensitive to cyclic loading. Shrink-wrap or netting may become loose as a result of creeping of the commodity which it is supposed to secure. The items become dislodged and are free to collide even under light impact conditions.

- **Shock Sensitive Commodities:** Certain types of freight will deform or fracture as a result of a single shock event. Canned products often lose their value if they are dented in transit. Brittle materials such as ceramics and hard plastics may fracture as a result of a shock event.

1.4 Types of Mechanical Freight Damage

There are several mechanisms that can cause damage a commodity so that it loses value during the transportation phase. Some of these may be described as follows:

- **Surface Damage as a Result of Collision:** If items can move relative to each other, either as a result of the settling of the load causing restraints to become slack or gaps to appear in the cargo in transit, it

is possible for collisions to occur within the load. An example of this is in the transport of canned food where the can forms part of the final presentation of the commodity.

- **Fracture of the Item or its Container:** Materials such as glass bottles are effectively insensitive to lower amplitude continuous vibration, which occurs in regular train motion, but may be fractured in single higher amplitude events such as during shunting.
- **Fatigue of the Item:** Fatigue is of concern especially where the item consists of a flexible spring-mass system such as a fly-wheel (the mass) suspended in the middle of a shaft (the spring). Although the damage may not be apparent immediately, internal fatigue cracks may develop leading to a shortening of the life of the item.
- **Surface Rubbing:** If relative motion between adjacent freight occurs, the rubbing surfaces can cause damage to each other. This effect has been observed in the transport of paper rolls under certain conditions and lading patterns.
- **False Brinelling:** Bearings that are loaded with a vibrating shaft can experience damage as a result of the oscillation of the rolling element over a small area of the race. A small depression may be worn into the race. This leads to premature failure of the bearing. This type of failure sometimes occurs in the transport of motor vehicles.

1.5 Causes of Freight Damage

1.5.1 Impact Initiated Damage

A typical operation mode on a railroad is for the wagon to be delivered to the client's siding for loading. After loading, the wagon is collected and moved to a marshalling yard where it is joined into a train. The train may be broken up to form other trains along the route. Each time the wagon is coupled to

another wagon, it experiences an impact. Each wagon is fitted with a shock-absorbing device known as a draw-gear. The draw-gear has the task of removing as much energy from the impact as possible. The energy may be absorbed through friction between surfaces, hydraulically or through the hysteresis properties of rubber. The damage usually occurs in a single event and results in fracture or deformation.

The subject of impact absorption has been addressed extensively by Dutton (1990). He developed mathematical techniques to model rolling stock impacts and evaluated the relative performance of various draw-gears.

1.5.2 Train Handling

For many years, the handling of trains has been blamed for freight damage. In a discussion chaired by Davis (year unknown), it was pointed out that this is often made the culprit for damage. In other words, the driver is blamed for the damage to the freight in the train.

Between each knuckle on mating couplers there can be 40 mm of free slack. The pocket components and knuckle pins can contribute more than 30 mm each side. In other words, it is possible for there to be more than 100 mm free slack between wagons. In addition to this there is the controlled movement of the draw-gear, that is displacement of the draw-gear mechanism itself, which may be between 60 and 90 mm each side. If the 100 mm free slack per wagon is taken over a fifty-wagon train, it can have more than 5 m total free slack. When a train is stretched going up hill and then bundles when the train starts descending, the shock pulse runs to the back of the train like an increasing wave. This is why the dynamic environment is worse near the back of the train than the front. It is also the reason why the guards van at the back of the train became unpopular. The tendency in passenger trains is to use a minimum brake application to ensure that the train remains stretched. This is wasteful of both energy and brake blocks.

1.5.3 Atmospheric Environment

Certain commodities such as fresh produce and industrial chemicals are sensitive to atmospheric conditions such as temperature and moisture content. Special apparatus such as insulated or refrigerated containers are available to solve this problem.

1.5.4 Vibrational Environment

This type of damage arises from the interaction between the dynamic properties of the freight and the wagon. Initial excitation may arise from longitudinal train action, that is the impacts resulting from bundling and stretching of the train, or from the track through the suspension elements. The vibrations may induce shifting of the load, component fatigue or surface fatigue and rubbing.

1.6 Analysis Tools

1.6.1 Fragility Index

A common method of expressing the resistance of a commodity to shock is to specify the acceleration that it can withstand in terms of gravitational acceleration, g. Hanlon (1971) suggests that this can be translated into a height for a drop test. The package would be raised to the prescribed height and allowed to fall freely onto a surface. After the drop, the package would be examined for damage.

The reduction of commodity strength to a single number, however, is a simplification that ignores the influence of the duration of the acceleration pulse on the fracture or resistance to deformation of a component. A military specification addresses this problem by using a two dimensional approach with the pulse width or change in velocity as one parameter and acceleration amplitude as the other.

In the rail environment, the pulse width is influenced by the type of draw-gear, for example, rubber or hydraulic, that is fitted and the dynamic stiffness of the wagon structure.

1.6.2 Modal Analysis

A technique to determine the natural, or modal frequencies of an item and how the item deflects when vibrating at these frequencies is known as modal analysis. In this procedure, a known forcing function is applied to the item and its response to the force is measured. The data are manipulated using mathematical methods to extract the modal frequencies and deflection, or mode shapes. This technique is discussed further in Chapter 4 .

A modal analysis of a wagon-freight system can yield useful information. The natural frequencies of the system can be estimated both analytically and empirically. This information may be used as input to a frequency response analysis of the freight-packaging system.

Dominant mode shapes can be isolated and the interaction of the freight with the mode shape determined. This is useful in investigating the mechanisms that cause shifting of the freight to occur.

Once the modal properties of the system are known, computational structural modification techniques can be used to investigate the effect of altering the structural dynamic properties of the wagon.

There have been studies of the effect of coach stiffness on passenger ride comfort such as the one reported by Bogdanov (1982). His work centred on the analysis of bending modes and analysed their possible removal using damping elements.

The vibrations that cause damage to freight are not only those due to bending and torsion, that is flexible modes, which result from deflection of the wagon deck structure itself, but also the rigid body modes, that is, roll,

yaw, bounce etc, which result from the deflection of suspension elements and not the wagon deck structure.

1.6.3 Dynamic Simulations

The dynamic equations that arise in analysis of freight response usually contain non-linearities such as Coulomb friction and hysteresis effects that make it difficult solve them analytically without linearising approximations.

Several dynamic simulation packages are available to assist in the numerical solution of these problems in the time domain.

1.7 Problem Solving

1.7.1 Impact Analysis

Often it is the single impact event that causes freight damage. It is therefore an important first step to analyse the behaviour of the freight under impact conditions. Typically this would involve a test that simulates the three modes of marshalling yard impact. First the wagon runs on its own into a string of stationery vehicles. This mode of impact is known as a rolling-free impact. The coupled wagon is then impacted by another wagon, known as a standing-solid impact mode. The wagon may be standing alone stationery on a line when struck by another wagon: a standing-free impact.

Often, a weak freight lading pattern will be identified in the impact testing stage. It is important that all three impact modes are tested since the wagon response, pulse width and amplitude could vary from mode to mode.

-OVERVIEW-

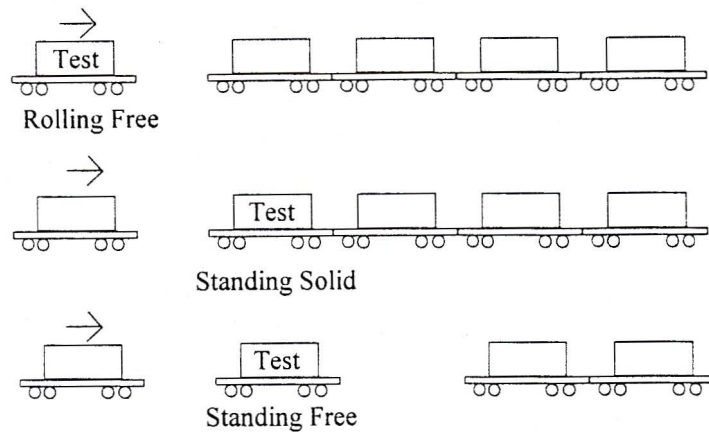

Figure 1.2 Impact test configurations

1.7.2 Dynamic Analysis

If the impact research shows that the problem results from vibrations, oscillations or deflections of the wagon structure, a dynamic analysis such as an experimental and analytical modal analysis will be required. The results of these analyses then need to be correlated and extended to a structural modification analysis to identify and correct for the vibration mode that may cause damage to the freight.

1.8 Related Research

The various components that go to make up the dynamic environment experienced by the freight were discussed in 1.2 . Each of these have been explored separately and the results published by the researchers concerned.

Testing of the basic strength of freight is offered by various laboratories such as the Trace Laboratories (1997), Environ Laboratories (1997) or GH Testing (2001) and many others. Authors such as Parkes (2000) and Gorman (2000) comment the best practice for testing of packages. They both advise the use of instrumentation to avoid the need to destroy too many samples of the commodity that is under test. These tests are often limited to simple drop tests which take magnitude and **not** pulse width into account.

Authors such as Mester (1997) and Hanlon (1971) do, however, mention the importance of pulse width, or momentum change, during the shock event, on the possibility that the item will fail. Texts such as that by Krausz & Eyring (1975) go into detail about the time-force relationship required for deformation to occur.

The importance of vibration and the protection of freight were outlined by Simmons & Shackson (1971) in their comparison between the spectra for air, road and rail transport. The relevance of frequency inputs to freight protection design is further underlined by the cost study for a shaking table for testing of packing materials by the International Union of Railways (1962). The sensitivity of certain commodities, especially electronics, to specific frequencies is outlined by Irvine (2001 a & b) who points out each component will have its own natural frequency and potential resonance problems.

An extension of the investigation into the freight environment is the studies of impacts between wagons by authors such as Dutton (1990) and Anderson, Singh & Miller (1996). The focus of these studies was the force level transferred to the freight during the impact. The principle of the force being the rate of change of momentum was the basis of these studies. In other words, the task of the draw-gear was to minimise the rate of momentum transfer. The properties of the wagon structure were not central to these studies.

There have been many researchers working on bogie models. These include Bailey, Wormley & Hendick (1989) who built a mathematical model of the bogie including hysteresis elements. Fujimoto, Tanifuji & Miyamoto (2000) looked at the influence of varying the rail gauge on vehicle dynamics. Michelberger, Bokor, Keresztes & Várlaki (1987) derived a model of the vehicle using linear techniques mainly focussing on the bogie elements. Keresztes, Bokor, Várlaki & Michelberger (1989) then published further

developments on the model to cope with the situation where only some of the dynamic properties are known. Scheffel (1978) developed a self-steering bogie and discussed its stability.

Research activities that have been centred on the structure were those by Bognadov (1982), Hillel, Sayer & Phipps (1975) and Coutellier, Ravalard & Oudin (1991). Their work, however centred around passenger ride comfort. They produced modal models of passenger coaches and then extended the output of this to be the input to the transfer function model of the seat. Tanifuji (1991) used a beam model for assessment of ride comfort.

Modal analysis has become a well-established field. Klosterman & Zimmerman (date unknown) describe the modal analysis technique with some of the earlier implementations. Coutellier et al (1991) and Vu-Quoc & Olsson (1989) use sub-structuring to reduce the size of the model that must be solved for their ride comfort investigation. Cotterel (1975) suggested ways of grouping parameters to reduce the size of high order vehicle models. Persson & Holgersson (date unknown) also published the results of a modal model of a passenger vehicle. No indication could be found that this has been extended to the dynamic environment of freight.

1.9 Objectives

This research set out to identify a link between the structure of a wagon and the response of freight that is carried by the wagon. To minimise the cost of protecting freight in transit, it is essential to have an understanding of the dynamics that contribute to the damage of the freight. It is often accepted that an impact will have a vertical component. The use of modal analysis can contribute to the description of this effect.

Thus the following objectives were set:

1. **Building Blocks that form Wagon-Freight Dynamic System:** The configuration of a loaded wagon will probably change for each load. It will not be practical to perform a full analysis on each possible configuration. Consequently, the intention was to explore a method where the vehicle-freight system could be broken down into each of its contributing components. The vehicle would consist of its body, draw-gear and bogie. The freight would also be handled as a separate dynamic component.
2. **Influence of Using Linear Approximations of Dynamic Coupling:** A linear coupling between the freight and the wagon would simplify the process of treating the wagon and freight as sub-structures. This simplification was also identified as an area to be explored.
3. **Freight Response Models:** Methods of interpreting geometric and dynamic properties of freight into a model for the freight response were required. Models for understanding how freight would respond to possible inputs were constructed.
4. **Assembly of Building Blocks:** The final objective was to unify the modelling of the dynamics of a wagon under continuous vibration and impact conditions. As a first step this would best be achieved using linear techniques before non-linear components are added to the model. The use of a building block approach would open the possibility of deploying a simple-to-use model to assist consultants in assessing freight configurations for clients.

Chapter 2 THE METHOD OF INVESTIGATION

2.1 Introduction

A wagon and its load make up two components of a dynamic system. The wagon transmits inputs from the coupler and the suspension to the freight. The freight will be susceptible to certain of the inputs and immune to others.

The wagon is common to all the transport configurations. It is essentially constructed from a series of steel beams. The analysis of a complex structure like this can be conducted with relative facility using linear modal analysis techniques.

The freight, on the other hand, must be examined as strongly internally damped structure. This hysteretic nature of the freight leads to non-linearities in the resulting equations, that is, they become difficult to solve, or unsolvable, in the frequency domain. One method available for accommodating the non-linear nature of the freight material is to analyse this aspect in the time domain. This then opens the way to using differential equation solution programs. Another type of non-linearity that occurs is associated with an irreversible event such as slippage, plastic deformation or fracture. Usually, when the non-linearity arises, this is indicative of the failure of the freight or freight protection system and this can be used to identify the limit in the model. Modelling of the freight is consequently directed towards identifying these conditions for failure.

Once the damage constraints for the freight and the dynamic characteristics of the wagon are known, these can be integrated into a composite model to optimise the relationship between packaging cost and vehicle based freight protection systems.

2.2 Experimental Approach

2.2.1 Wagon Modal Characteristics



Figure 2.1 Typical Container wagon (from <http://www.de.dorbyl.com/rsd/wagons.html>)

A typical wagon can have a tare in the region of twelve to twenty tons and a gross mass in the region of eighty tons. The size of the available actuator was limited, consequently, it was not practical to excite a fully loaded wagon, and therefore an empty wagon was used instead. The intention was then that sub-structuring techniques would be used to build the full picture.

The SHL-5 wagon investigated for this research consisted of a freight deck constructed from channel sections with a flat sheet in the draw-gear area at each end of the wagon and an under-frame fabricated from angle sections. The unloaded wagon weighed about twelve tons. A structure of this size requires large sources of excitation. Attempts were made to take measurements using a modal-hammer, drop test and a shaker. First the wagon was struck with a modal-hammer at the reference point. The acceleration of the response points was then recorded and analysed. Second, the wagon was dropped 25 mm onto an instrumented track. An attempt was then made to relate the accelerations to mode shapes. The third and most successful technique involved using a shaker attached to the reference point and measuring the response. The mode shapes excited could then be extracted using single reference- multiple response techniques. A sixteen channel piezo-electric system was available for measurements. These outputs were recorded for later analysis.

Once the mode shapes were extracted, the effect of the mass of the freight could be added to the model. Since the freight portion of the model would change for each payload, it would be useful to be able to separate the constant component, the wagon, from the changing component, the freight.

2.2.2 Freight Parameters

Unlike the wagon, the freight normally exhibits large amounts of internal damping. Consequently, much of the freight response is determined by the damping properties of the commodity.

For the purposes of this work, a cylindrical paper roll was used as an example. It is known that these rolls do move in transit causing damage to the outer layers of paper. The rolls are about 600 mm diameter, 800 mm to 1000 mm long and weight about 1000 kg. No equipment, such as a large shaker, existed on site to dynamically excite the roll to facilitate the extraction the dynamic parameters of the paper roll so a static method was chosen instead. This was further justified by the low frequencies involved. The paper roll was placed in a press as shown in Figure 2.2 and the force displacement curves were plotted. Since a time domain model for the roll was to be used, the scaled version of the resultant hysteresis loop could be used.

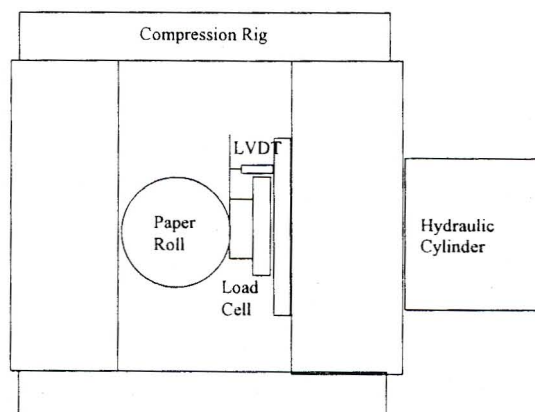

Figure 2.2 Compression test layout

2.3 Mathematical Modelling of Wagon Structure

2.3.1 Finite Element (FE)

The geometry of the wagon was modelled using beam elements for the angle iron and channel sections in the under-frame and rectangular shells for the sheet metal decks at either end of the wagon. The riveted joints were assumed to be rigid, although they would be somewhere between a rigid and pinned joint.

The advantage of an FE model is that it can be constructed without access to the wagon and test equipment. The disadvantage is that the parameters such as Coulomb friction in the joints are not taken into account and this can lead to inaccuracies in the model.

2.4 Wagon Excitation Sources

2.4.1 Rail

Much work, such as that by Fröhling, Scheffel & Ebersöhn (1995), Grassie (1989) and Anderson & Dahlberg (1998), has been done in the area of the excitation that the wheel in contact with the rail experiences. The wheel essentially experiences random excitation from track irregularities. In addition to this, the sleeper spacing and train speed superimpose a regular component on the input spectrum. These excitations interact with the geometric, mass and stiffness characteristics of the bogie to transfer forces to the superstructure of the wagon. For the purposes of this work it is sufficient to reduce this to the spectra transferred to the superstructure of the wagon because it is the deflection and acceleration of the wagon that interacts with the freight.

2.4.2 Shunting Impact

When trains are being assembled, wagons are often allowed to run freely into still standing wagons at speeds in excess of 3 m/s. A shock-absorbing device known as a draw-gear is installed behind the coupler. Depending on the construction of the draw-gear, the magnitude, width and rise time of the force pulse varies.

Previous undocumented tests at Engineering Development Centre have shown that the vertical acceleration experienced by freight under impact conditions can be in the same order of magnitude as the longitudinal acceleration. This vertical component reduces the normal forces between the freight and the wagon allowing for horizontal shifting and consequential damage of the load.

The effect of shunting yard events were simulated by winching a wagon a pre-determined distance up a ramp with an incline of 8° and allowing it to run into other wagons. Instruments were applied to the test wagon draw-gear to measure force and acceleration.

2.5 Train Action

Free-play between wagon couplers and draw-gear displacement contribute to the shocks experienced in the train. If a train is fully stretched when the locomotive slows down suddenly, the back-most wagon can run a substantial distance before it will feel the effect of the wagon in front of it slowing down. This introduces a sizeable shock input into the wagon. Data from line tests, in other words, data acquired using instrumentation applied to a real train, would show the magnitude, spectrum and occurrence frequency of the excitation to the wagon structure resulting from the train action. The problem with attempting line tests is that the train drivers tend to be more careful when driving a test train and good train handling prevents the normal train action events. It was reasoned that the results obtainable

from impact tests would give the same information as attempting to derive them from line tests.

2.6 Mathematical Modelling of Freight

2.6.1 Time Domain

2.6.1.1 Time Response

Where the failure of the freight, or freight configuration, is indicated by non-linearities in its dynamic behaviour, the motion is best investigated in the time domain. Horizontal motion generally leads to damage of the commodity. Consequently, the models used explore the point at which horizontal motion would occur.

For cylindrical objects, rotation in synchrony with the bending, torsion or rolling of the wagon does not lead directly to failure. Asynchronous vertical rotational movement causes relative motion between the cylinder and the wagon resulting in scuffing and tie-down loosening.

The vertical response determines the contact force and hence the frictional or adhesion forces. The interaction and phase of the vertical and horizontal forces therefore determines the frequency and amplitude conditions under which slipping and therefore damage is most likely to occur.

The differential equations were defined and then solved numerically on a differential equation solver known as ACSL, which stands for "Advanced Continuous Simulation Language".

2.6.1.2 Geometric Relationships

The mode shapes of the wagon express the deflection of the wagon at specific frequencies. If a natural frequency of the freight corresponds to a modal frequency of the wagon, then the freight will be excited by that mode. This phenomenon would cause particular problems where the commodity is

fatigue sensitive or internal vibration damage could occur in elements such as bearings.

If, for example, the freight is a horizontal cylinder, and the wagon mode shape a bending mode, then the cylinder will experience a net rotational effect.

A rocking motion in a single plane would not adversely affect a vertical cylinder. A twisting mode with damping effects altering the phase between nodes or another mode of slightly shifted frequency could result in the normal to the surface tracing out a cone like shape. This could result in a net rotating force acting on the cylinder. Rotation of the cylinder may result in scuffing damage.

2.6.2 Frequency Domain

Freight such as machinery and vehicles are susceptible to fatigue of shafts and false Brinelling of bearings. These failures are usually analysed using techniques such as rain-flow counting. Sherratt and Bishop (1990) and Heyns (1995) proposed methods for constructing estimates of fatigue data from spectra. Since the vibration spectrum can be estimated from the modal information, it follows that fatigue estimates can also be derived.

2.7 Quantification of the Strength of Freight

2.7.1 Drop Test

The easiest way to measure the strength of a commodity is to raise it to a predetermined height and release it. Using the method described by Hanlon (1971) and many test facilities, the strength can then be expressed in terms of maximum height of drop from which no damage occurred. This method, although simple, does not take the pulse width broadening effects of shock absorbing devices into account.

2.7.2 Fragility Index

A drop test will only determine whether a package will suffer damage if it is dropped. In a transport environment, the accelerations experienced differ somewhat in duration and amplitude from those experienced during a direct impact. This introduces the need for a method that makes provision for pulse width or velocity change and acceleration amplitude. The conditions under which failure occur may best be represented graphically and are known as the fragility index or damage boundary (the term damage boundary also is used to refer to the point at which failure occurs during a drop test). The data from a fragility test are presented as acceleration amplitude (in g's) versus the change in velocity, which is essentially the pulse width. The failure curve is asymptotic to a pulse width below which there is insufficient time for enough energy to be transferred to cause damage. An amplitude asymptote exists at the acceleration level where static strength of the item exceeds the maximum force resulting from acceleration level. This is discussed further in 11.2.2.

Fragility tests are performed by decelerating the item from a predetermined velocity using programmable actuators. Usually nitrogen cylinders are used for the test. The relationship between pressure and area can be used to alter the acceleration level and pulse width.

2.8 Freight Response to Wagon Inputs

2.8.1 Frequency Matching

Should it happen that one of the natural frequencies of the freight matches that of the wagon, then the response of the freight could be such that damage levels are accentuated. It is therefore useful to estimate the dynamic properties of the freight and match them to those of the wagon.

Since the failure characteristics of the freight were best expressed in the time domain, namely the beginning of slip or pulse width and amplitude, the frequency domain mode shape data were taken to construct a time domain model. Special consideration was given where the mode frequency was close to the natural frequency of the freight. Also of interest was the condition where the vertical movement of the freight was small in comparison to that of the wagon surface since this would be where separation and damage are likely to occur.

2.8.2 Magnitude of Input

While the freight does not slip, become separated from the wagon, deform or fracture, the coupling between the freight and wagon can essentially be analysed using linear techniques. Once one of these failure mechanisms start to occur, however, the model can no longer be linear. At this point it is likely that damage has occurred and the configuration is not satisfactory for transport of the specific type of freight. The objective then is to detect the condition in the model where the non-linearity occurs and use this as the limiting condition for accepting or rejecting the freight configuration.

Chapter 3 PACKAGING

3.1 Introduction

Packaging of commodities can serve an aesthetic, functional and protective purpose. The design of the package will depend on the major thrust of its application.

A beverage can, for example, serves an aesthetic function in that it is usually painted to attract the consumer and display the manufacturer's logo. It also forms a functional purpose in that it is equipped with a pull ring for easy opening and it lends itself to use in vending machines. The choice between two similar products will often depend on which has the more attractive or user-friendly packaging rather than the technical superiority of one of the consumer items. Consequently, great deal of money is spent on the appeal of the packaging.

Industrial users, on the other hand, are primarily interested in the applicability of the commodity for their process. Sometimes the packaging needs to be specially designed to assist the introduction into the process. Examples of this are special spouts on bulk powder containers, or special orientation of components for automatic unpacking.

The primary function of most forms of packaging is to protect the commodity from damage while it is being moved from source to destination. The form of the packaging may vary from a protective layer that covers the commodity such as a layer of plastic to a container lined with shock isolating materials. Then role and form of packaging is outlined further by In-Touch (2000) .

3.2 Design Considerations for Packaging

3.2.1 The Manufacturer's Perspective

Once a commodity has reached its destination, the packaging is usually discarded and therefore does not add to the intrinsic value of the product. Its aesthetic value is also forgotten and any costs that are package-related are added to the product price and will detract from the product in the consumer's eyes. This will probably have a negative influence in the attraction to the product, that is, the consumer will buy a lower priced competing product. Consequently, it is usually desirable to minimise the cost of the packaging material while maintaining its aesthetic, functional and protective characteristics.

The packing procedure also becomes an important component of the packaging design. Automatic packing machines must be able to handle the packaging, insert the product and close the package. A human packer has the advantage that alignment and dispensing the material is not as complex but the production rate is likely to be much slower. The design requirements of packaging used in a mechanical plant therefore differ from those of a manual operation.

3.2.2 The Carriage Point of View

Possible areas of damage to freight occur in two main areas. The equipment used for handling the packages, such as forklifts, can result in impact events caused by dropping of the packages. The transport vehicle introduces vibration and shock events from the environment in which it operates. Road vehicles experience events from bad surfaces and other driving conditions. Rail vehicles are not affected as badly from the running surface but do experience train-action related impact events. Both types of vehicle have their own vibration environment resulting from structural and suspension stiffness characteristics.

Apart from protecting the product from the elements, the packaging provides protection from mechanical damage. The shock and vibrations experienced by the package is a function of the mode of transport used and the handling procedures. Simmons and Shackson (1971) showed a comparison between typical vibration spectra that may be expected on rail, sea, road and air modes. The vibrations may be divided into two classes: those that arise from single events and those associated with continuous vibrations. The packaging should therefore isolate the freight from both types damage.

Most specifications for packaging are based on drop tests such as those described by Hanlon (1971) and specification ASTM3332. The drop test is simple to perform and is consequently offered by many laboratories and is described in 3.3.1.

Where several items are bound together into a single package, it is important that no settling occurs within the package resulting in slack and consequential collision damage. It is often necessary to perform vibration tests with a shaker to ensure that the binding will not slacken in transit.

3.2.3 Aspects of Interest to the Recipient

If the recipients are industrial clients who will be processing the commodity further then their only interest is the condition of the commodity itself. In this case, the packaging only serves a protective function.

If, on the other hand, the recipients are domestic users, their acceptance of the product may also be influenced by the appearance of the package and not necessarily on the contents alone. Scratches or abrasions on the packaging may be considered as damage to the product. Even a dented tin may be considered unacceptable since the consumer may not be certain that the vacuum seal has not been compromised. On the other hand, large appliances are usually sold by displaying the product itself and, once again, the packaging performs a protective rather than aesthetic role.

3.3 Testing of Packaging for Impact and Vibration Protection

3.3.1 Drop Test

The simplest expression of the strength of a package is the height from which it can be dropped without damage. Specifications such as ASTM 3332 and authors such as Hanlon (1971) describe this type of test. Gorman (2000) describes a refinement, and that is to attach accelerometers to the product and plot the acceleration pulse that is experienced. The data can then be extended from testing the actual product to a simulation of the product. Usually it is necessary to drop a boxed package on all six sides and on the corners. Since each test configuration has the potential to destroy a sample of the product, using the actual product can be costly. Equivalent models are preferred to save the cost of more expensive commodities. A detailed knowledge of the acceleration versus velocity change (fragility index) is required to interpret the results.

Packaging design graphs are available which give the acceleration experienced by the commodity as a function of isolation thickness for a standard drop height. Hanlon has tabulated some guides to the relationship between package thickness and acceleration.

3.3.2 Fragility Index

It takes time for freight to deform to the state where damage occurs through permanent deformation or fracture. In addition to this, the forces or accelerations must be high enough to generate the stresses required for failure. The drop test only takes the amplitude of the acceleration into account and ignores the duration of the event. Another way to look at this is that deformation and fracture failures require a certain amount of energy to occur (Krausz and Eyring, 1975). For that energy to be transferred to the freight time and strain or displacement are required. If the time is too short or

displacement is too low then no damage can occur. The military addressed this problem by developing the fragility index specification.

The test requires an apparatus that can vary not only the amplitude of impact but also the duration. The results of the test are then presented as a function of change-in-velocity, or pulse width versus acceleration amplitude.

Typically, the test load would be accelerated to a predetermined speed using a long stroke actuator. The load then impacts an impact-programmer, probably filled with a pressurised gas, which imparts a deceleration pulse. The amplitude of the acceleration is primarily a function of the velocity at impact and the pulse width depends most strongly on the pressure of the gas.

If part of the freight becomes dislodged, it is likely that it will be damaged or cause damage. Consequently, a freight-lading pattern may be able to have a fragility index value as will the individual components of that package. The fragility index for individual components can be used to specify substitute model characteristics for instrumented packaging analysis tests.

Since each point on a fragility curve leads to the destruction of a sample of the product, many samples of the product are required.

3.3.3 Shaker Simulations

Both the drop test and the fragility index are single event tests. Some forms of damage depend on an accumulation of events. This is best tested using a shaker. The driving signal for the shaker can be white noise with the same frequency spectral properties of real data or portions of real data may be used. Compensation needs to be made for the test rig's own dynamic properties. It is often difficult to choose portions of data to use to represent the journey. Usually a rain-flow counting technique is used to identify sections of high vibrational activity.

3.3.4 Line Tests

Before experimentation can be performed in a laboratory, it is necessary to collect data on an actual train. To do this, a coach containing data acquisition equipment would be attached to the train. Instruments for measuring the relevant quantities could be applied to wagons in the train.

Laboratory tests rely on simulating reality by attempting to match test parameters and data acquired in the field. Often the three-dimensional transport problem is reduced to a single dimensional representation. There is always the problem of proving the validity and applicability of the test. It is often the tendency to err far on the conservative side. This results in a more expensive solution than may be necessary.

Line data are necessary as an input to the design process. It is also often necessary, once the engineering and laboratory work is completed, to verify the design and assumptions with a line test. A typical line test would consist of preparing a load of the intended commodity or a similar geometry using a mock-up of the load. Accelerometers and possibly strain gauges would be placed in critical positions on the load to determine its response. The resulting signals can then be analysed on a digital computer. The frequency content is usually expressed in the form of power spectral densities and cross-spectra determine the phase interrelationship between channels. Amplitude information is best expressed in the form of histograms. Peak or peak-valley counts serve to show the amplitude and occurrence information. Rain-flow counts, which take number of occurrences, magnitude and mean value into account may better express the fatigue aspects for packaging design.

3.4 Modelling - Differential Equations with Solvers

A freight system may be reduced to a set of state space equations. The representation of the damping depends on the accuracy required from the

model. The introduction of combinations of Coulomb and hysteretic damping, which would give improved accuracy, introduces non-linearities into the equations. Analytical solutions then become difficult if not impossible to derive. It is consequently useful to use one of the time domain dynamics packages to solve the problem numerically. This does not remove the necessity for testing the properties of the freight.

Knowledge of the operating environment that would be obtained from the line tests or modal tests forms the basis for the excitation functions used in the model. Product strength properties have to be obtained from drop or fragility index tests. Stiffness and damping parameters can be derived from drop tests and static compression tests.

Chapter 4 MODAL ANALYSIS - A PROBLEM SOLVING TOOL

4.1 Introduction

In the design and research fields one of the important aspects is to link the mathematical modelling technique with the physical structure. In the case of the static result, strain gauges are often placed at points that are identified as being critical. When performing an evaluation of the dynamics of a design, the link is provided by modal analysis.

The classical theory applied to structures assumes that the structure is linear or sufficiently linear that the errors incurred are not too significant. In other words, gaps and non-viscous damping and non-linear springs must be represented as linear approximations.

The dynamic, or modal model can be built analytically from known mass, damping and stiffness characteristics. This is usually achieved using techniques such as finite element analysis. A physical structure can be analysed by imparting a known response to the structure and measuring the structural response using accelerometers or sometimes strain gauges. The two models can then be linked using a statistical technique by constructing the modal assurance matrix which expresses the probability that mode shapes derived from two different techniques are the same mode.

4.2 Modal Behaviour and the State-Space Matrix

A two degree-of-freedom linear model may be used to illustrate the concept of modal-analysis. Consider the illustration in Figure 4.1 .

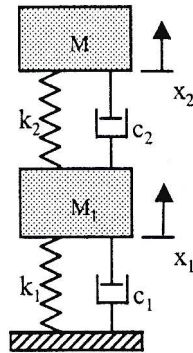

Figure 4.1 Two Degree of Freedom System

The equations of motion for a free vibration are as follows:

$$\begin{aligned} M_1 \ddot{x}_1 + c_1 \dot{x}_1 - c_2 (\dot{x}_2 - \dot{x}_1) + k_1 x_1 - k_2 (x_2 - x_1) &= 0 \\ M_2 \ddot{x}_2 + c_2 (\dot{x}_2 - \dot{x}_1) + k_2 (x_2 - x_1) &= 0 \end{aligned}$$

(4.1)

Isolating the state terms

$$\begin{aligned} M_1 \ddot{x}_1 + (c_1 + c_2) \dot{x}_1 - c_2 \dot{x}_2 + (k_1 + k_2) x_1 - k_2 x_2 &= 0 \\ M_2 \ddot{x}_2 - c_2 \dot{x}_1 + c_2 \dot{x}_2 - k_2 x_1 + k_2 x_2 &= 0 \end{aligned}$$

or

$$\begin{bmatrix} M_1 & 0 \\ 0 & M_2 \end{bmatrix} \begin{bmatrix} \ddot{x}_1 \\ \ddot{x}_2 \end{bmatrix} + \begin{bmatrix} (c_1 + c_2) & -c_2 \\ -c_2 & c_2 \end{bmatrix} \begin{bmatrix} \dot{x}_1 \\ \dot{x}_2 \end{bmatrix} + \begin{bmatrix} (k_1 + k_2) & -k_2 \\ -k_2 & k_2 \end{bmatrix} \begin{bmatrix} x_1 \\ x_2 \end{bmatrix} = \begin{bmatrix} 0 \\ 0 \end{bmatrix}$$

or

$$\mathbf{M}\ddot{\mathbf{x}} + \mathbf{C}\dot{\mathbf{x}} + \mathbf{K}\mathbf{x} = \mathbf{0}$$

(4.2)

Introduce new state variables such that

$$\begin{aligned} y_1 &= \dot{x}_1 \\ y_2 &= \dot{x}_2 \end{aligned}$$

(4.3)

Substituting (4.3) in(4.2) and separating orders of derivatives

$$\dot{y}_1 = \frac{-(c_1 + c_2)y_1 + c_2y_2 - (k_1 + k_2)x_1 + k_2x_2}{M_1}$$

$$\dot{y}_2 = \frac{c_2y_1 - c_2y_2 + k_2x_1 - k_2x_2}{M_2}$$

(4.4)

Combining (4.3) and (4.4) in matrix notation

$$\begin{bmatrix} \dot{x}_1 \\ \dot{x}_2 \\ \dot{y}_1 \\ \dot{y}_2 \end{bmatrix} = \begin{bmatrix} 0 & 0 & 1 & 0 \\ 0 & 0 & 0 & 1 \\ -\frac{(k_1 + k_2)}{M_1} & \frac{k_2}{M_1} & -\frac{c_1 + c_2}{M_1} & \frac{c_2}{M_1} \\ \frac{k_2}{M_2} & -\frac{k_2}{M_2} & \frac{c_2}{M_2} & -\frac{c_2}{M_2} \end{bmatrix} \begin{bmatrix} x_1 \\ x_2 \\ y_1 \\ y_2 \end{bmatrix}$$

(4.5)

Rewriting in symbolic notation

$$\dot{\mathbf{z}} = \mathbf{A}\mathbf{z}$$

where

$$\mathbf{z} = \begin{bmatrix} x_1 \\ x_2 \\ y_1 \\ y_2 \end{bmatrix}$$

and

$$\mathbf{A} = \begin{bmatrix} 0 & 0 & 1 & 0 \\ 0 & 0 & 0 & 1 \\ -\frac{(k_1 + k_2)}{M_1} & \frac{k_2}{M_1} & -\frac{c_1 + c_2}{M_1} & \frac{c_2}{M_1} \\ \frac{k_2}{M_2} & -\frac{k_2}{M_2} & \frac{c_2}{M_2} & -\frac{c_2}{M_2} \end{bmatrix} = \begin{bmatrix} \mathbf{0} & \mathbf{I} \\ \mathbf{M}^{-1}\mathbf{K} & \mathbf{M}^{-1}\mathbf{C} \end{bmatrix}$$

(4.6)

Since the system is assumed linear, the motion will have the form

$$\begin{aligned}x_i &= X_i e^{\lambda_i t} \\ \dot{x}_i &= \lambda_i X_i e^{\lambda_i t}\end{aligned}\tag{4.7}$$

(4.7) may be rewritten as

$$\lambda \mathbf{z} = \mathbf{A} \mathbf{z}\tag{4.8}$$

This is an eigenvalue problem whose roots match the natural frequencies and damping of the system. The eigenvector corresponding to each eigenvalue represents the shape in which the structure would deflect were it to be excited at that frequency alone. In other words, an estimate of the natural frequencies of a system with a finite number of degrees of freedom can be made analytically provided the properties of the system are known. The frequency response of a system may also be determined by exciting the system with a measured input and measuring the output. It is here that the analytical and experimental approaches may be drawn together. Ewins (1988) describes a method of correlating modes known as a Modal Assurance Criterion (MAC). The MAC gives an estimate of the least squares error between the calculated and measured mode shapes.

The analytical solution characterises the system by determining the state matrix whereas the experimental solution determines the eigenvalues (square of the complex natural frequencies) and eigenvectors (mode shapes). It is difficult to estimate structural damping analytically, consequently, it is often ignored in the analytical solution.

Since (4.8) represents one natural frequency, it is useful to represent all the mode shapes in a single form.

$$\underline{\Psi} \underline{\lambda} = \mathbf{A} \underline{\Psi}$$

Where:

$\underline{\Psi}$ is the modal matrix whose columns are the eigen vectors of (1.8)

$\underline{\lambda}$ is a matrix with diagonal terms equal to the eigen values corresponding eigen vectors in Z

\mathbf{A} is derived from the spatial model

(4.9)

The eigenvalues are the square of the natural frequencies, ω_i^2 , so $\underline{\lambda}$ can be rewritten as in (4.10)

$$\underline{\lambda} = \begin{bmatrix} \backslash & & 0 \\ & \omega_i^2 & \\ 0 & & \backslash \end{bmatrix}$$

(4.10)

The modal-model then consists of two components, the square of the modal frequencies and the mode shapes. The mode frequencies, ω_i^2 , are the eigenvalues and have fixed magnitude. Eigenvectors, which represent the mode shapes, ψ_i , on the other hand, may be scaled by any convenient factor for representation without altering the solution. The model then consists of the two matrices

$$\begin{bmatrix} \omega_1^2 & & 0 \\ & \omega_2^2 & \\ 0 & & \omega_n^2 \end{bmatrix} \quad \text{and} \quad \begin{bmatrix} \Psi_1 & \Psi_2 & \dots & \Psi_n \\ | & | & & | \\ | & | & & | \\ | & | & & | \\ | & | & & | \end{bmatrix}$$

or

$$\begin{bmatrix} \omega_i^2 \end{bmatrix} \quad \text{and} \quad \begin{bmatrix} \Psi \end{bmatrix}$$

(4.11)

Using the methods of Ewins (1988) and Craig (1981) this leads to the transformation from modal co-ordinates to spatial co-ordinates given in (4.12)

$$\mathbf{x} = [\Psi] \mathbf{p}$$

where

\mathbf{x} – spatial co – ordinate

\mathbf{p} – modal co – ordinate

$[\Psi]$ – mode shape matrix

(4.12)

Ewins (1988) showed that a co-ordinate system can be selected such that all the vectors are linearly independent. In other words, each mode of vibration may be considered separately and the effects added together.

4.3 Frequency Response Functions

To determine the dynamic properties of a structure, the response to an excitation is measured. The frequency and phase response characteristics at various points on a structure are expressed as a ratio to the excitation at one or more reference points giving the frequency response function (FRF). Although it is not necessary to induce a known excitation (Heyns, 1995), many of the techniques currently used involve the use of a known input. The forcing function from a modal hammer or shaker is used as a reference for the frequency response functions at selected points on the structure.

4.4 Spatial Response Functions

The FRF expresses the frequency coupling characteristics of two points. A structure is made up of an infinite collection of these points. Discreet points on the structure need to be chosen to represent the structure. The representation then becomes an array of functions expressing the frequency coupling between the discreet points on the structure.

Since a linear structure vibrates in a series of frequencies, it is useful to analyse the structure at these specific, natural frequencies. If a structure is excited at one natural frequency, it will deflect in a specific shape with varying amplitudes (both negative and positive) at each of its points. It is the function that describes this deformation shape that is known as the mode shape. Since the structure has been divided into discrete points, it is sufficient to express the mode shape as a vector representing the position of the structure at a given instant.

It should be noted that since the structure is represented as a series of discrete points, the possibility exists that some deflection information may be lost between points. This may lead to incomplete representation of the true mode shape. This effect is analogous to the aliasing that may be observed in a data sampling system and is sometimes referred to as spatial aliasing.

The mode shape may be determined experimentally by exciting the structure and analysing the response. Finite element techniques also may be used to determine the mode shape. In other words, the mode shape represents the link between analytical and experimental work in structural vibration analysis as may be seen in (4.8).

4.5 Modal Analysis Path

4.5.1 Experimental Approach

4.5.1.1 Preparation of Structure

For modal analysis to be performed on a structure, the structure needs to be divided up into a finite collection of points where the dynamic characteristics may be measured. Issues such as spatial-aliasing and local stiffness effects need to be addressed. Also, the structure is normally suspended on light springs to eliminate fixing effects. In the case of large structures such as bridges, buildings and wagons, however, this becomes impractical and

grounded models are usually used. In the case of the wagon-freight interaction, the rigid-body modes are also relevant to freight response.

4.5.1.2 Excitation

The aim of the experimental approach is to collect empirical data from which the frequency response characteristics of one point with respect to the other points can be determined. Since the system is assumed linear, this is usually summarised as the response with respect to an input at a single point. The linearity of the structure allows the excitation to be moved to the selected points on the structure and the response measured at the single reference point or the excitation to be placed at a single point and the response measured at the other points on the structure.

Various excitation sources are available. A shaker may be used to excite the structure. The shaker must be attached to the structure through a load cell to measure excitation force. A slender rod known as a sting is usually used to couple the exciter to the structure. This avoids any unmeasured moments being induced in the structure. The frequency of input signal may be swept to cover all the frequencies of interest or a random signal with energy spread throughout the frequency spectrum of interest may be used. The advantage of using a shaker is that the input is well controlled and repeatable results may be achieved. The size of structure that can be excited is limited by the size of the shaker. The structure may be struck with a calibrated modal hammer. The advantage of this system is that larger amounts of energy can be introduced into the structure. The quality of the result depends on the skill of the operator. Consequently, the results obtained with a hammer are generally not as well defined as those obtained with a shaker.

4.5.1.3 Mode Shape Extraction

Various techniques exist for the identification of modal frequencies. The more complicated techniques yield more accurate results with the cost of more computing resources, time and expertise.

The simplest procedure for the identification of modal frequencies is the peak picking method. In this method, the mode is identified by manually selecting the frequency of maximum amplitude on the FRF. This method, however, has the disadvantage that it only considers one degree of freedom at a time. It also acts on discrete frequency lines whereas it is likely that the peak falls between two lines. This leads to discrepancies between the peaks associated with a specific mode on different measurement points. The multivariate techniques tend to yield a more homogenous estimate of the modal frequencies of the entire structure although they require longer computational times.

After the modal frequencies and damping have been determined, an analytical representation of the experimental FRFs is calculated. The mode shape associated with each frequency may then be determined.

4.5.2 Finite Element Approach

Since the objective is to be able to make predictions using a mathematical model, it is important to model the structure as closely to the experimental structure as possible. In the case of a structure, which is supported on light springs, it makes sense to use spring elements to support the model rather than attach the model directly to a fixed ground point. This is especially true in the case of a large structure where representative grounding stiffnesses produce a more credible model.

Many finite element packages allow the calculation of theoretical vibration modes. Several calculation methods are available with their advantages and disadvantages. The Simultaneous Vector Iteration (SVI), for example,

requires less storage space and lends itself to large models. The accuracy of the result depends on the number of iterations performed. Guyan reduction, as explained by SDRC (1992b), SDRC (2001b) and Clemson (2001), performs a direct matrix manipulation which is more predictable as far as computing time is concerned, but requires larger amounts of computer memory to do the matrix operations. Depending on the method deployed for solving the model, it may be necessary to select primary degrees of freedom. These should be chosen to correspond with the measurement points. This allows the measured data to be correlated with the finite element result. One method available for correlating mode shapes is the Modal Assurance Criterion, described in 4.5.3. The results for comparing each combination of mode shapes are conveniently represented in a matrix form.

4.5.3 Modal Assurance Criterion Matrix

The modal assurance criterion (MAC) is a measure of the probability that the two mode shapes correlate and is defined as follows:

$$MAC_{j,k} = \frac{\left| \sum_{i=1}^n z_j^*(i) z_k(i) \right|^2}{\sum_{i=1}^n z_l^*(i) z_j(i) \sum_{i=1}^n z_k^*(i) z_k(i)}$$

j, k = modes compared

n = number of degrees of freedom

z = mode shape co-efficient

(4.13)

This scalar compares the shape of the two vectors while removing scaling information. If the shapes are well correlated the MAC will tend to a value of one, whereas for a poorly correlated shape, the MAC will tend to zero.

The MAC also indicates the linear independence of different modes. The actual correlation may be affected by noise on the test signal.

To facilitate comparisons, it is convenient to make a three dimensional plot of the contents of a MAC matrix. This allows the correlated modes to be identified together with an indication of multiple modes that exhibit a degree of correlation.

4.5.4 Structural Modification

Once a model of the test structure has been refined, then changes need to be made to the structure to solve the problem being identified. The problem could be an unwanted resonance or, as in the case of this research, the addition of other dynamic entities to the model. This is done by adding elements to the model and calculating their effect on the dynamics. In other words, the relevant entries in the mass and stiffness matrix are adjusted to accommodate the modifications. The calculations are performed at the points where the spectra were measured. Consequently, it is only possible to make changes at the node points included in the modal model. The planning phase of the test should keep this in mind. The measurement points should be chosen in such a way that any modification that may be required can be performed at these points. Some relief from this constraint can be achieved when using finite element models that are verified with experimental models since a more detailed set of modal matrices can be extracted.

Generally a modal analysis is performed to identify troublesome frequencies and then modify the structure to change the frequency. This may be done by adding mass, stiffness or damping at one of the nodes of the structure. The analysis software can then modify the modal matrices to predict the effect of the change. In the analysis of freight, the aim is to assemble a single structure from the wagon and freight. In other words, effects of masses and springs that have not been included in the test may be added to complete the system.

Chapter 5 FREIGHT - WAGON AS A DYNAMIC SYSTEM

5.1 Introduction

The simplest analysis of a wagon system models the wagon as a single mass and uses momentum and energy principles to analyse the effect on the goods. Although this may be used to understand many freight response effects, it does not help in the modelling of the vibrations that cause freight shifting and settling while the wagon is in motion. It also does not completely model the translation of a horizontal impact into a vertical vibration. It is this combination of wagon flexing in the vertical direction and horizontal acceleration of the wagon that results in the shifting of freight in transit.

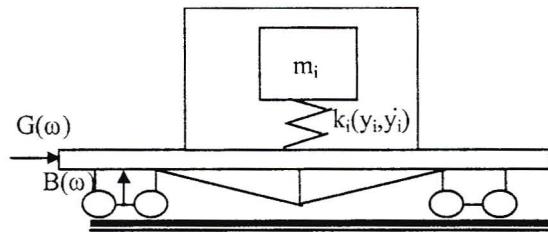

Figure 5.1 Components of Dynamic System

A loaded wagon, as shown in Figure 5.1, could be modelled as a load, or a series loads with mass m_i . The loads would be coupled to the wagon through stiffness element, k_i , which depends on the relative displacement between the wagon and the freight, y_i , and the relative velocity, \dot{y}_i . The deck of the wagon receives excitation through the coupler, which has transfer characteristics: $G(\omega)$, and from the bogie, with transfer characteristics: $B(\omega)$.

If the system can be assumed to be linear, then the individual components that form part of the system may be treated individually to derive the total system response. Depending on the source of the excitation, different components will contribute differently to the input.

If the input originates from the wheels, the characteristics of the suspension elements will have a greater effect. The natural frequencies of the springs and the damping effects will have a significant effect on the frequency content of the input to the wagon structure.

In-train action effects are transferred to the wagon structure via the draw-gear. The construction of the draw-gear varies considerably depending on cost and the degree of protection offered. Specifications for draw-gears define the energy absorption capabilities and peak force transmission.

Owing to the non-linear nature of both the draw-gear and the Coulomb damped suspension, it is probably more informative to treat these systems as spectral sources to the wagon structure. For a certain impact speed, the frequency content of the force pulse transmitted by a draw-gear will be reasonably consistent. Consequently, the shape of the force-time curve will define the spectral excitation of the structure.

A part of the bogie input can be predicted to some degree from theoretical studies of hunting frequencies such as those done by Sheffel (1978) but the component resulting from track irregularities would have to be measured. The bogie input would therefore be best measured at the force transfer points.

5.2 Sub-Systems

5.2.1 Draw-gear

The draw-gear is essentially a spring-loaded shock absorber. The energy absorption could be from internal hysteresis, friction elements or hydraulic damping. Although these types of elements introduce severe non-linearities into the system, it is only the frequency transmission that is of interest. This is analogous to the different heads used on a modal hammer where the spectral input is determined by the hardness of the rubber.

The frequencies introduced by the draw-gear may be considered to be an excitation spectrum that is introduced into the wagon structure. The excitation results from discrete impact events resulting from train action.

A Fourier transformation of the force pulse gives the frequency domain input resulting from the impact event. This, when multiplied by the frequency response functions (FRF) from the modal test, will give the response of the structure.

5.2.2 Bogies and Suspension

The suspension elements determine both the frequency of excitation experienced by the wagon structure and the rigid body frequency characteristics of the wagon. The significant suspension components comprise of spring packs and perhaps rubber sandwiches on self-steering bogies. Coulomb damping is provided by Barber wedges. When considering the shifting and damage to freight it is both the flexible and rigid body deflections that contribute to the dynamics experienced by the freight. In other words, both the spring-mass interaction between the structure and the suspension, and the excitations transferred through the bogie to the structure need to be considered.

In the same way as the draw-gear introduces a longitudinal excitation spectrum, the bogie suspension introduces a vertical excitation. The spectrum resulting from the bogie, unlike that from the draw-gear, results from a continuous random excitation.

The bogie will transmit frequencies depending on the characteristics of the components that make up the bogie.

5.2.3 Wagon

Traditionally, the dynamic response of the freight is modelled using a stiff mass to represent the wagon. Although this may be true of a heavy-duty

wagon, the response of a slender wagon will have a significant component attributable to the flexing of the wagon. Most wagons used for transporting general freight, as opposed to bulk minerals, consist of an underframe and a superstructure. The underframe consists of longs at floor level with a truss construction below to add strength and stiffness.

The wagon structure is not homogeneous and therefore must be represented as an array of frequency response functions as shown in (5.1).

$$Y(\omega) = \mathbf{H}(\omega) \bullet F(\omega)$$

where

$Y(\omega)$ – vector of frequency response functions

$\mathbf{H}(\omega)$ – array of transfer functions of wagon

$F(\omega)$ – vector of excitation functions

(5.1)

Once the frequency characteristics of the wagon structure between excitation points and transfer points to the freight have been identified, then the response to any input can be determined. The force-time characteristics of the draw-gear will determine how the structure is excited during impact. The frequency functions from the bogie input will determine the continuous vibration environment.

5.2.4 Freight

The freight component of the system often changes for every consignment. Each freight component could consist of the commodity surrounded by some form of packaging to prevent damage. A series of packages then combine to form a complex multi-degree-of-freedom system. Depending on the type of commodity under consideration, it may be appropriate to lump the masses and stiffnesses into a simplified model. For specialised consignments,

protection of fragile components may be of interest, in which case, a more detailed analysis will be required.

A more detailed analysis could use a technique such as the second modal coupling method described by Ewins (1988) may be used. In this method, the two independently identified systems are coupled with a spring and possibly a damping element as expressed by the coupling stiffness matrix, $[K_{sys}]$. The forces are then transferred between the two sub-systems, the freight and the wagon, as shown in (5.2).

$$\begin{Bmatrix} f_{wagon} \\ f_{freight} \end{Bmatrix} = [K_{sys}] \begin{Bmatrix} y_{wagon} \\ y_{freight} \end{Bmatrix}$$

where

f_{wagon} – force on wagon

$f_{freight}$ – force on freight

$[K_{sys}]$ – stiffness matrix of coupling

y_{wagon} – wagon node vertical co – ordinate

$y_{freight}$ – freight node vertical co – ordinate

(5.2)

The model for each of the systems must first be expressed in terms of modal co-ordinates as shown in (5.3).

$$\mathbf{y} = [\phi] \mathbf{p}$$

where

\mathbf{y} – original co – ordinate vector

$[\phi]$ – mode shape matrix

\mathbf{p} – modal co – ordinate vector

(5.3)

The equation of motion, as derived by Ewins, then becomes:

$$[I] \begin{Bmatrix} \ddot{p}_{wagon} \\ \ddot{p}_{freight} \end{Bmatrix} + \left(\begin{bmatrix} \phi_{wagon}^T & 0 \\ 0 & \phi_{freight}^T \end{bmatrix} [K_{sys}] \begin{bmatrix} \phi_{wagon} & 0 \\ 0 & \phi_{freight} \end{bmatrix} + \begin{bmatrix} \omega_{wagon}^2 & 0 \\ 0 & \omega_{freight}^2 \end{bmatrix} \right) \begin{Bmatrix} p_{wagon} \\ p_{freight} \end{Bmatrix} = \begin{Bmatrix} 0 \\ 0 \end{Bmatrix} \quad (5.4)$$

This equation may be solved for the eigenvalues and eigenvectors for the coupled system. This is normally done using a modal analysis package or a specially developed program can be used for verifying the feasibility of the loading configurations.

With the approximations that have to be made in determining the freight properties, it is usually sufficiently accurate to lump the effect of the freight into a series of masses coupled to the nodes of the structure through a stiffness element for each package.

Chapter 6 FREIGHT DYNAMICS

6.1 Introduction

The objective of this chapter was to outline various models that could be applied to various freight configurations. Equations were developed and are presented in this chapter as proposed methods of analysing different types of freight.

The configuration of freight will vary from load to load. Consequently, it is more useful to represent the freight as a separate mathematical model. This can then be added to a separate, reusable model of the wagon.

Various types of freight were explored. Each case had its own unique characteristics. A set of typical considerations is presented in the form of mathematical models:

- Cylindrical items (rolls of paper) were chosen as a special case since these are specifically applicable to the paper industry where problems have been experienced. They are unique in that any rotation that occurs is likely to cause damage. The equations derived and boundary conditions used are an original contribution by the author to the understanding of the damage that occurs in the transport of paper rolls.
- Fatigue response is particularly relevant to the motor car industry. Shafts and bearings have been known to fail prematurely as a result of vibrations experienced during transport. Heyns (1995) and Sherratt & Bishop (1995) presented methods of estimating fatigue histories from vibration spectra.
- Tie-downs that are used to secure freight may become slack. This results from a dynamic interaction between the freight and the tie-

down. The tendency is to apply a tie-down diagonally, that is, partly in the vertical direction and partly in the direction of motion. A reduction of the normal force, hence reduction in friction between the freight and vehicle can occur where there is vertical excitation from the vehicle. At the same time, the horizontal force component in the tie-down remains the same or increases. This results in small movements of the load leading to tie-down becoming slack. Thereafter the freight is free to move even more, resulting in damage. The model developed is an original contribution by the author to the field of tie-down design.

6.2 Cylinders

6.2.1 Horizontal Cylinders

6.2.1.1 Model Description

For the purposes of this model it was assumed that each cylinder or paper roll receives its excitation through the wagon. In other words, the motion of each roll was unaffected by the motion of adjacent rolls. Consequently each roll could be considered independently and the model could be based on the analysis of a single cylinder.

It was also assumed that the roll was constrained to have no translation. This was justified on the grounds that translation would probably be associated with rolling and that the damage associated with rolling is much less than that caused by slipping. In addition to this, the adjacent freight or the end wall of the wagon would prevent translation.

Figure 6.1 shows a cylinder that is loaded at the end of wagon that is oscillating in the first bending mode. The distance from the centre of the wagon is L . The displacement of the point of contact between the wagon and the cylinder is y_1 and the mass centre of the roll moves a distance y_2 .

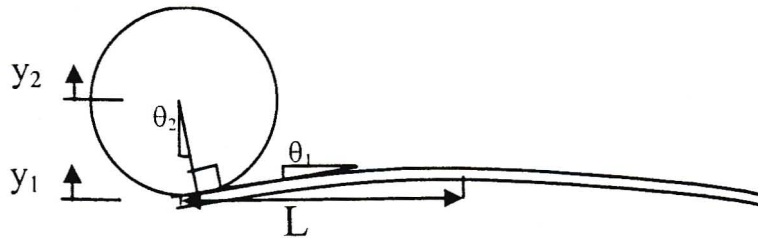

Figure 6.1 Cylinder on wagon vibrating in first bending mode

As the wagon deflects, the tangent at the point of contact rotates through an angle θ_1 similarly, the cylinder rotates through an angle θ_2

To simplify the model, the wagon was replaced by a rigid beam of length L , pivoted at the end as shown in Figure 6.2.

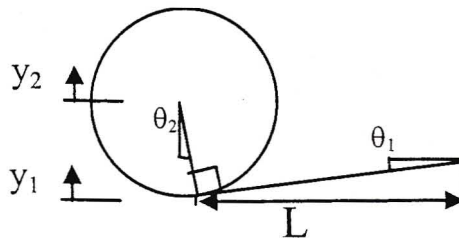

Figure 6.2 Simplified model of cylinder on wagon

The input to the cylinder initiates from the harmonic variation of θ_1 .

If the cylinder moves in synchrony with the wagon deflection, the cylinder rotation, θ_2 , will be equal to the rotation of the wagon deck, θ_1 . Slipping of the cylinder on the wagon will result in deviations between the two angles.

The vertical motion of the point of contact between the wagon and cylinder constitutes a vertical input. If θ_1 is small, the motion of this point can be expressed as shown in (6.1).

$$y_1 = \theta_1 \cdot L$$

(6.1)

The vertical response of the cylinder was modelled using a lumped mass, supported on a non-linear spring as shown in Figure 6.3. The stiffness of the spring is a function of its compression and the direction of motion. In other words, force as a function of displacement follows a different path on the compression part ($\dot{y}_1 - \dot{y}_2 > 0$) of the cycle to the expansion part ($\dot{y}_1 - \dot{y}_2 < 0$) of the cycle.

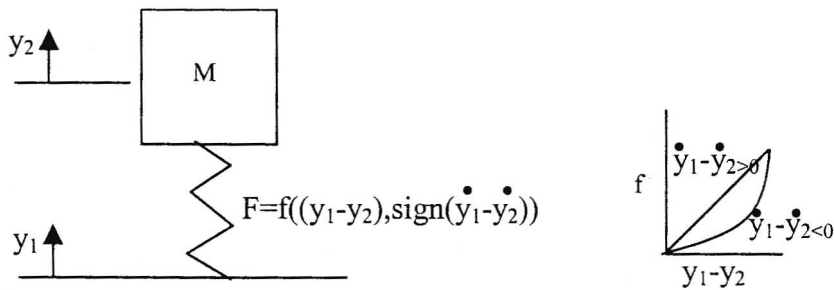

Figure 6.3 Lumped Mass Model

$$M \ddot{y}_2 + f((y_1 - y_2), \text{sign}(\dot{y}_1 - \dot{y}_2)) - Mg = 0$$

(6.2)

The rotation forces on the roll are transferred through contact surface with the wagon. When no sliding occurs, the maximum torque is related to the spring force, f , by the coefficient of static friction, μ_s , and the radius of the cylinder, r . The maximum torque that can be transferred between the wagon and the roll is given by (6.3).

$$\tau_{max} = \mu_s Fr$$

where

τ_{max} – maximum available torque

μ_s – coefficient of static friction

F – normal force between wagon and cylinder

r – radius of cylinder

(6.3)

The torque actually required to accelerate the cylinder at the same rate as the wagon is given by (6.4).

$$\tau = J\ddot{\theta}_1 = J\ddot{\theta}_2$$

where

τ – torque required

J – moment of inertia of cylinder

$\ddot{\theta}_1$ – angular acceleration of wagon

$\ddot{\theta}_2$ – angular acceleration of cylinder

(6.4)

Slipping will start to occur if the demanded torque exceeds the frictional torque available. In other words, the condition expressed by (6.5) applies.

$$\tau > \tau_{\max}$$

(6.5)

During slipping, the torque of the cylinder is no longer that which is shown by (6.4) rather is determined by the sliding friction and the radius of the cylinder as shown in (6.6).

$$\tau = J\ddot{\theta}_2 = \mu_d Fr$$

where

μ_d – dynamic friction co-efficient

F – contact force between wagon and cylinder

r – radius of cylinder

(6.6)

The slipping will stop when the angular velocity of the cylinder matches that of the wagon surface ($\dot{\theta}_1 = \dot{\theta}_2$). These conditions were compiled into a time domain model, the results of which are given in 11.4

6.2.2 Vertical Cylinder

Sometimes cylinders are loaded with their axes vertical. In this case, it is the orbiting of the axis that will cause the shifting of the freight.

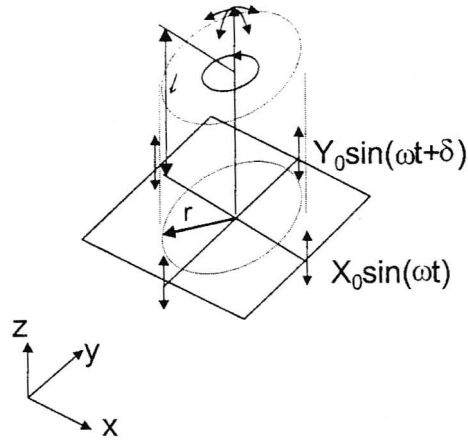

Figure 6.4 Normal to the wagon surface with phase shift between responses

The cylinder shown in Figure 6.4 is on a surface that experiences a vibration. If it is assumed that the centre point of the cylinder is stationary, and the points on the x-axis oscillate at a frequency ω . That is, the cylinder oscillates in the X-Z plane about the centre point with a frequency and the points on the y-axis oscillate at the same frequency but with a phase difference of δ . Both the motions defined by x and y are in the vertical, z, direction. then the motion of the top of the cylinder will follow the ellipse defined by (6.7).

This orbiting of the mass centre about the neutral point can cause the cylinder to rotate. From this it can be seen that a cylinder on a damped structure can experience a rotational effect. If the centre of the cylinder is not stationary, the entire cylinder will experience a vertical motion superimposed on the rotation. Similar effects to this were observed when bottles in a tray were shaken using a white noise generator.

$$x = X_0 \ell / r \sin(\omega t)$$

$$y = Y_0 \ell / r \sin(\omega t + \delta)$$

where

x – motion of normal in x – direction

X_0 – magnitude of oscillation in x – direction

y – motion of normal in y – direction

Y_0 – magnitude of oscillation in y – direction

ℓ – length of roll

r – radius of roll

ω – frequency of oscillation

δ – phase difference between x – and y – oscillation

t – time

(6.7)

A similar situation exists where two modes are close together. In this case the oscillation on the x -axis will have a frequency of ω and the y -axis is $(\omega + \Delta\omega)$. The effect is shown in (6.8), this is the same equation as for Lissajous figures. The cylinder will follow a more complex path but nonetheless it will experience a rotation as with the case where there was a phase shift.

$$x = X_0 \sin(\omega t)$$

$$y = Y_0 \sin(\omega t + \Delta\omega t)$$

where

x – motion of normal in x – direction

X_0 – magnitude of oscillation in x – direction

y – motion of normal in y – direction

Y_0 – magnitude of oscillation in y – direction

ω – frequency of oscillation

$\Delta\omega$ – frequency difference between x – and y – oscillation

t – time

(6.8)

6.3 Fatigue Response

Each stress cycle experienced by a component may cause damage, which accumulates until failure of the component. This is particularly true where the natural frequency of a specific sub-assembly is excited. This is of specific interest in the transport of electromechanical instrumentation where miniature shafts are used.

6.4 Tie-Down Slackening

Referring to Figure 6.5 it can be seen that during the tightening process, as the force in the tie down, T , increases the normal force, N , on the wagon-freight interface increases as does the horizontal component, h . The friction force, however, is sufficient to lock the freight in its loaded position, preventing the freight from moving to take up free space between items. Under dynamic conditions, however, vertical accelerations cause a reduction in normal force and hence friction restraints. Longitudinal accelerations and the horizontal component of the tie-down tension, h , can cause the freight to move. This results in slackening of the tie-down, after which the freight is free to collide with adjacent freight.

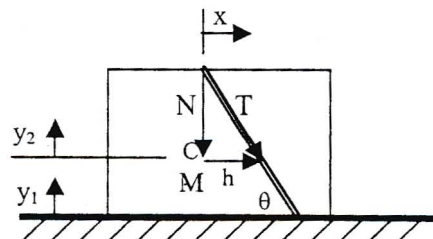

Figure 6.5 Tie-down Slackening

The mass of the box is assumed to be concentrated at the centre, C , and the equivalent stiffness between the mass centre and the lower part of the package is k_f . If symmetry is assumed then the stiffness between the mass centre and the top is also k_f . The stiffness of the tie-down is k_t . This

effectively suspends the mass centre, c , between three springs. The spring coupling the mass to the base, with stiffness k_f , is in parallel with the series combination of the box stiffness to the top of the box, k_f and the tie-down stiffness, k_t .

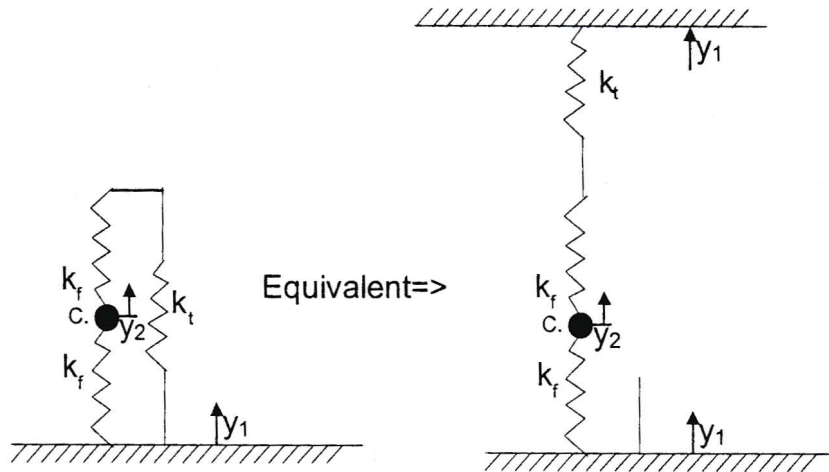

Figure 6.6 Relationship between stiffness elements

The equivalent stiffness, k_e , is therefore given by (6.9)

$$k_e = \left(\frac{1}{k_f} + \frac{1}{k_t} \right)^{-1} + k_f$$

where

k_e – equivalent stiffness of tie – down and package

k_f – stiffness of freight between mass centre and bottom or top

k_t – stiffness of tie – down referred to vertical direction

(6.9)

The natural frequency, ω_n , can be approximated by (6.10)

$$\omega_n = \sqrt{\frac{k_e}{M}}$$

where

ω_n – natural frequency of tie – down and package

k_e – effective stiffness of tie – down and package

M – mass of package

(6.10)

Tie down slackening will occur when the horizontal force exceeds the friction force. If it is assumed that the only horizontal force arises from the tension in the tie-down then the horizontal force, h , is give by (6.11).

$$h = T \cos \theta$$

where

h – horizontal component oftension

T – tie – down tension

θ – angle between tie – down and horizontal

(6.11)

This does not take impact events into account where a vertical impulse is accompanied with a horizontal acceleration.

The contact force, N between the surfaces is given by (6.12).

$$N = (y_1 - y_2)k_f$$

where

N – normal force

y_1 – displacement of wagon

y_2 – displacement of package

k_f – stiffness of package between mass centre and bottom

(6.12)

The forces on the package result from the vertical component of the tie-down, the reaction from the floor, and gravity. The equation relating the vertical forces and acceleration of the mass may be written as:

$$M\ddot{y}_2 = -N - Mg + (y_1 - y_2)k_f \quad (6.13)$$

The tension, T , in the tie-down is given by the initial tension added to the additional forces resulting from the vertical movement of the package.

$$T = T_0 + (y_3 - y_1)k_t / \cos \theta$$

where

T_0 – initial tension
 y_1 – vertical displacement of wagon
 y_3 – vertical displacement of top of package

$$(6.14)$$

The normal component, N , is given by

$$N = T \sin \theta \quad (6.15)$$

This can be substituted into (6.13) to give the dynamic equation.

$$M\ddot{y}_2 = -T \sin \theta - Mg + (y_1 - y_2)k_f \quad (6.16)$$

It can be seen that if the excitation displacement, y_1 , is big enough, the contact force, N , will reduce to a point where the horizontal component will exceed the friction force and sliding will result. That is

$$h > \mu_s N$$

or

$$h > \mu_s (y_2 - y_1) k_f$$

(6.17)

Thus conditions can exist where the tie-down becomes slack. It will then no longer prevent horizontal motion of the freight. Once the freight has shifted the pattern should be considered as having failed.

6.5 Failure Criteria

6.5.1 Sliding

Whether the freight is restrained or unrestrained, surface damage will result if sliding occurs. The system needs to be designed so that the horizontal forces never exceed the friction forces.

6.5.2 Tie-Downs

Once the tie-down is ineffective, the freight is free to slide. The damage to the surfaces is then generally cumulative and depends on the intensity and number of subsequent events. Impact damage can result from the freight that is no longer constrained colliding with other objects. A freight pattern should be considered to have failed if slackening occurs. It is sometimes an advantage to build in some resilience in the tie-down by using elastic materials or extra springs to compensate for the slight movement of freight and prevent slackening.

Chapter 7 FREIGHT ISOLATION SYSTEMS

7.1 Introduction

A basic rail vehicle consists of three components that will affect the shock and vibration isolation efficiency of the vehicle. Vertical isolation is achieved through the bogie springs and dampers. Horizontal isolation is achieved using draw-gear mounted behind the coupler or buffers at the end of the car. Additional protection can be achieved using fittings such as air springs to absorb more of the vibrations.

When a system is chosen to protect the freight, several options need to be taken into account. Any packaging used will probably not be reusable and will therefore only add to the cost of production. A certain amount of handling will be needed and protection during this phase will be required. Protection systems that are built into the wagon add to the capital cost of the wagon and a subsequent maintenance cost. Additional items can be added to the freight such as securing frames to stabilise the items. These have the disadvantage that control needs to be exercised to ensure that they are returned to the sending station for re-use.

The selection of the type of isolation system has economic consequences. When the vehicle is designed to protect the freight, the result is a specialised vehicle for that commodity. Since it is unlikely that the same form of the commodity will be moved in the same route in both directions, this leads to specialised vehicles that are only useful in one direction. This re-usable system needs to be traded off against protective packaging that is used only once.

Although a certain amount of packaging is essential to avoid damage during handling, it is desirable to minimise this to save on costs. A protective covering may consist of a layer of cardboard or plastic for the tougher

commodities to foam and special structures for the more delicate commodities.

This chapter serves as a record of various analyses that were performed to model the systems that may be introduced to protect freight from damage.

7.2 Shock Absorbent Materials

Generally, the foam, cardboard, plastic or protective wrapping materials used for isolating freight exhibits an internal hysteresis characteristic. In other words, the force-displacement curve for compression lies above that for expansion. The area between the two curves represents the energy absorbed in the force cycle. The concept of hysteresis as an energy absorption mechanism is discussed in articles such as that by Sethna (1994) and Berg (1997).

Berg describes the properties of rubber and indicates that the hysteresis loop is essentially symmetrical. In a pseudo-static situation, the loop is essentially due to internal friction effects. At higher frequencies, viscous effects increase the size of the loop.

This symmetry of the hysteresis loop is not true for all materials and forms such as that shown on Figure 7.1 can also be expected.

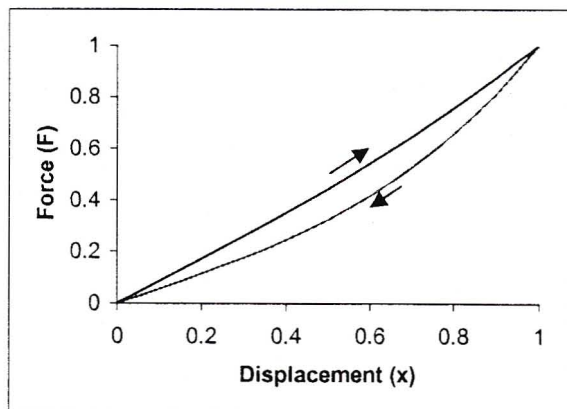

Figure 7.1 Typical Hysteresis Curve

Since the material does not obey Hooke's law, it essentially means that the model is no longer linear. This makes it difficult, if not impossible, to solve analytically in the frequency domain. It is, however, not a serious limitation if a time domain numerical technique is used because non-linear equations can be easily included in the program code for the model. The shape of force-displacement curve may be approximated by one of several analytical functions.

A hyperbolic sine function was selected to fit the data obtained from the compression of a paper roll in 11.3.1. This function took the form

$$F = F_{\max} \frac{\sinh(ax / x_{\max})}{|\sinh(a)|}$$

where

F = Force on roll

F_{\max} = Maximum force

x_{\max} = Maximum displacement

a = Shape factor

(7.1)

The shape factor, a , is used to change the curvature of the function. Certain materials, such as elastomers, can exhibit a convex appearance. Another function that can represent these curves takes the form

$$F = F_{\max} \frac{1 - e^{-ax/x_{\max}}}{1 - e^{-a}}$$

(7.2)

This function has the disadvantage that it is asymptotic to an upper force value. In both these cases, a non-linear relationship exists between displacement and the force. A least-squares approach to determine the constants in the relationship is not possible. Consequently, an iterative technique is required to find the best fit between the data and the curve. The

attraction of this type of fit is the compact nature of the function derived. A good approximation can be achieved using a single constant, the shape factor, and the end point of the curve. This is useful when scaling the curve to fit slightly different end conditions. Paine (1962) points out that the shape of the curve is speed dependent. In other words, the shape factor is a function of frequency.

Another option is to simply fit a polynomial to the curve. This curve is defined using three or more constants. The position of the end-point is determined by the value of the constants. In other words, a new set of constants must be calculated to move the end point. Compensating for speed dependence also becomes more difficult since a new set of constants would be required dependent on the speed of each cycle.

7.3 Vehicle Properties

7.3.1 Draw-gear

7.3.1.1 General Operation

The term draw-gear refers to the damping element that transfers the force from the coupler to the body of the wagon. The task of the draw-gear is to absorb as much of the energy as possible while keeping the force as low as possible. It must, however be kept in mind that there is a pulse width component in the failure of a component under shock conditions and it is possible that a shock absorber may convert a previously non-damaging narrow pulse into a wide damaging pulse.

Energy may be absorbed by several mechanisms: Coulomb friction between two rubbing surfaces, hysteretic absorption by elastomers or rubbers, or hydraulic fluids.

The maximum energy, E , that a draw-gear may absorb is expressed as

$$E = Fs$$

where

F – maximum force transferred by the gear

s – maximum stroke of the gear

(7.3)

One expression of the efficiency of a draw-gear is

$$\eta = \frac{\text{Absorbed Energy}}{\text{Maximum Energy}}$$

(7.4)

It can be seen from this definition that for a gear with a lower efficiency, a higher force level is reached to absorb the same amount of energy. Since momentum is conserved during an impact, in other words, the area under the force time curve remains constant, the pulse is much narrower for a less efficient gear. An inefficient draw-gear transmits higher forces and higher frequency components. More information about the characteristics of draw-gears of various constructions can be found in Dutton (1990).

7.3.1.2 All-Steel draw-gears

An all-steel draw-gear such as the Miner TF880 shown in Figure 7.2 consists of a set of springs to return the gear to its rest position. The springs push on a wedge mechanism, which forces friction shoes against a seat. Energy is absorbed by the friction between the shoes and the seat. The force is transferred to the wedge from the coupler by a plunger.

These gears are hard wearing and, because they do not contain special materials, are relatively inexpensive. Consequently, they have found favour in many general freight applications. They are especially useful for commodities that are insensitive to shock such as grains and ores.

Because they rely on mechanical friction to absorb their energy, the proportion of energy absorbed is smaller compared to other gears. This implies that the force transmitted through the gear is much higher. Also, dry friction components tend to stick and slip. This means that the gear does not transmit a single pulse but rather a series of pulses introducing higher frequencies into the structure.

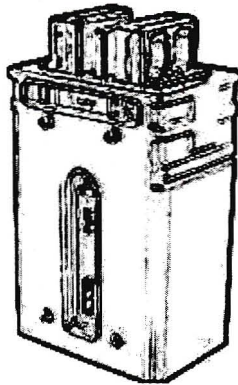

Figure 7.2 Miner TF880 all-steel draw-gear

7.3.1.3 Rubber Draw-gears

The rubber draw-gears rely on the ability of rubber to absorb energy. Rubber pads are constructed from materials chosen for their energy absorption capabilities and durability. The rubber pads are made into stacks and inserted into the draw-gear housing. The back of the coupler pushes on the end of the stack usually through a steel block to prevent localised distortion of the rubber. Because the rubber possesses its own stiffness, this supplies the return mechanism for the draw-gear. The hysteresis properties of the rubber supply the energy absorption required of the draw-gear. In certain models of draw-gear, steel friction elements are added to provide an even greater energy absorption ability. This mechanism is used on the Miner SL-76 shown in Figure 7.3. These rubber-friction gears are less susceptible to stick slip, than the all-steel gears, and are consequently preferred for

general freight and where shifting of freight can occur such as in the transport of rough sawn timber. Peak force transmission in rubber draw-gears tend to be lower than in all-steel gears

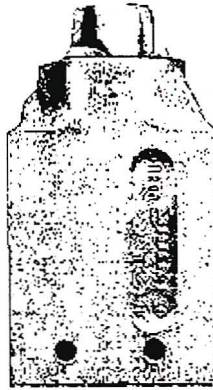

Figure 7.3 Miner SL-76 rubber-friction draw-gear

The addition of the specialised rubber may contribute to a slight increase of price compared to the all-steel gear.

7.3.1.4 Hydraulic Draw-gears

Hydraulic gears work on the principle of accelerating oils through an orifice usually attached to the plunger or piston of the draw-gear. Energy is absorbed by the fluid-dynamic process. The force pulse can be modified by introducing a pin with a variable profile into the orifice. The force then becomes a function of piston position and speed.

The piston is returned to its neutral position by a gas spring or a steel spring.

The gear offers a high efficiency and hence low peak force transfer levels. Unlike the rubber and all-steel gears, the construction of the gear requires close tolerance machining and seals. This means that the cost of this type of gear is several times higher than the other gears discussed.

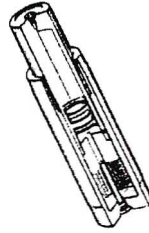

Figure 7.4 Sketch of Oleo draw-gear

The use of these gears is limited to protecting expensive vehicles or commodities. Their use is not wide spread in South Africa because they have to compete with the lower cost draw-gear types described in 7.3.1.2 and 7.3.1.3.

7.3.1.5 Elastomer Draw-gears

These draw-gears consist of a cavity filled with a compressible elastomer. The piston moves into the cavity reducing the volume occupied by the elastomer. Compression of the elastomer is an efficient energy absorbing mechanism. Consequently, force levels are low and pulse widths are wide. These draw-gears are not packaged to fit a standard draw-gear pocket and have not been widely used.

7.3.2 Structure

7.3.2.1 Association of American Railroads (AAR) compliant wagons

A typical wagon in South Africa is designed using the AAR guidelines. These guidelines specify that a wagon must be able to withstand a longitudinal static force equivalent to 350 tons. This immediately gives the wagon a certain degree of stiffness. In an effort to improve load-tare ratios, it has been suggested that this end load should be reduced. This implies a reduction in the stiffness of the wagon structure.

For less dense commodities, the tendency is to use longer wagons. A longer wagon will have a lower stiffness than a short wagon.

As the stiffness of the wagon reduces, the vibrations experienced by the freight as a result of wagon flexing will increase. If no compensation is made for the additional vibrations, damage to delicate freight can be expected.

7.3.2.2 Truss type underframes

To increase the strength and stiffness of a wagon, it is common practice to construct a truss like structure under the deck of the wagon. Depending on the form of the truss, different mode shapes and hence freight excitation may result.

The dynamics of the structure of the wagon are complex and are best described by its modal parameters. These may be determined analytically or by experiment, or, preferably by a combination of the two.

7.3.2.3 Sliding centre sill

In an attempt to give extra protection to fragile freight, the sliding centre sill (SCS) was designed. The couplers are mounted directly on a box column, the sliding centre sill, which runs the length of the wagon. The SCS is suspended from the wagon by long stroke hydraulic cylinders. The wagon body will then float and effectively be isolated from the train forces. This principle works well when the entire train is made up of SCS wagons. If, however, the wagon is mixed with A.A.R. compliant wagons, the shocks that are normally absorbed by the draw-gears are transmitted to the SCS. This causes the slender SCS to flex translating the longitudinal train action into vertical shocks of equal or greater magnitude. This has led to significant freight losses.

7.4 Suspension

The suspension arrangement of a wagon tends to have to be a series of compromises. The load on the springs may vary from just the superstructure to full load. A primary cluster of springs separates the bearing housing from the bolster. In series with this, a secondary cluster supports the bogie centre.

Damping is usually achieved using Barber wedges. These are dry friction elements. In other words, a Coulomb-damping model is required.

It is not only the bending modes that contribute to the shifting and fatigue of the freight but the rigid-body as well. Consequently, the bounce, roll, pitch and yaw allowed by the suspension needs to be considered when investigating the influence on freight integrity.

The excitation received by the suspension via the wheels can be repetitive cycles that may excite resonant frequencies. These inputs can result from sleeper spacing or wheel defects. In both cases, the frequency is train speed dependent. Innovations such as ballastless beam-track (Engineering News, 2001), remove the repetitive inputs present in current rail geometries.

Many studies have been done to determine the frequencies that are generated from the wheels. Most of the studies such as that by Gracheva (1982), Fröhling, Scheffel and Ebersöhn (1995) and Esveld (1989) have a special focus on the wheel-rail interaction rather than the transfer to the freight. The spectra derived by their work can be transmitted to the wagon structure via the transfer characteristics of the bogie.

7.5 Freight protection devices

7.5.1 Custom designed cradles

Certain specialised services such as the transport of polished steel rolls have made it feasible to manufacture specialised cradles. The product is

particularly dense so the load limit on the wagon is reached rapidly. In this case, the empty cradles can be stacked closer together for the return leg of the journey. This helps to alleviate the loss of the empty leg. A good example of such a device is the "paper saver" that was tested by Scott and de Bruyn (1994).

7.5.2 Air springs

If vibration or shock is a problem with a particular commodity, air springs can be used to isolate them from the wagon. Unlike conventional steel springs, the resonant frequency does not depend on the actual static deflection of the spring. Two types of air spring can be used. A simple pneumatic cylinder may be used. This, however, will require an accumulator to extend the volume to give the necessary characteristics. Problems may also be encountered with leaks. Inflated rubber bags may also be used for this purpose. The air pressure will have to be adjusted to match each load. Special care must be taken to prevent damage to the cushion when it is not inflated.

The disadvantage of air springs is that the wagon then becomes a specialised vehicle. Additional maintenance procedures will be required. Control measures will have to be implemented to avoid supplying damaged wagons. Additional training will be required to ensure that the system is inflated correctly for the journey.

To model the behaviour of an air spring, the adiabatic gas equation may be used.

$$PV^\gamma = \text{const}$$

(7.5)

If it is assumed that the spring is initially in equilibrium with the load then the force, F_0 , applied to the spring with a plunger area, A , will give rise to an initial volume, V_0 , and pressure, P_0 .

$$P_0 V_0^\gamma = C$$

or

$$\frac{F_0}{A} V_0^\gamma = C$$

where

P_0 - initial pressure

V_0 - initial volume

F_0 - preload

A - spring area

γ - ratio of specific heats

(7.6)

If a small disturbing force, f , is applied, this will cause a displacement, x . Substituting the new pressure into (7.6) gives (7.7).

$$\frac{(F_0 + f)}{A} (V_0 + xA)^\gamma = \frac{F_0}{A} V_0^\gamma$$

where

$F_0 + f$ - applied force

x - spring displacement

(7.7)

Solving for f

$$f = F_0 \left[\left(\frac{V_0}{V_0 + xA} \right)^\gamma - 1 \right]$$

(7.8)

To find the stiffness, (7.8) must be differentiated with respect to displacement to give (7.9).

$$k = \frac{\partial f}{\partial x} = \frac{\gamma F_0 V_0^\gamma A}{(V_0 + xA)^{\gamma+1}}$$

(7.9)

If the volume of the spring is large in comparison to the change in volume, then the stiffness is essentially constant.

7.6 Freight Protection Compromise

If a product is to be subjected to handling and sorting, then the packaging needs to comply with the applicable drop test specifications. In the bulk transport market, however, where block loads are used, the protection can be built into the wagon instead. This saves on material and space usage in the vehicle. The choice of isolation system becomes a trade off between the capital cost of the vehicle, transporting of packaging, and the cost of packaging.

Chapter 8 MODAL TESTING OF WAGON STRUCTURE

8.1 Introduction

To gain an understanding of the interaction between the wagon and the freight, it was necessary to identify the characteristics of the wagon. These could then be used as the excitation in a dynamic model of the freight.

If a lading pattern is to remain stable, it is essential that the freight remain in contact with the wagon. If the frequency characteristics of the freight are such that its motion relative to the wagon reduces friction forces to a level where sliding may occur, the configuration should be considered unsuitable since freight damage may occur. To determine if this condition could exist, a modal-model of the wagon was constructed. Although a comparison of the response of a loaded and empty wagon would have been of interest, none of the excitation methods available could supply sufficient energy and coherence to give acceptable results under loaded conditions. Consequently, the wagon was modelled separately and then the influence of the freight could be added to the model.

Several methods of excitation were attempted before usable results were measured. The structure could be excited using an impact which would be imparted by dropping the wagon from a small ramp, running another wagon into the wagon or using a large modal hammer. Continuous excitation could be achieved using an actuator.

This chapter describes the experimental work that was performed to determine the frequency response functions (FRF) for the wagon. These FRF's were then ported to a modal analysis package, which was used to analyse the mode shapes.

8.2 Methods of Excitation

8.2.1 Drop

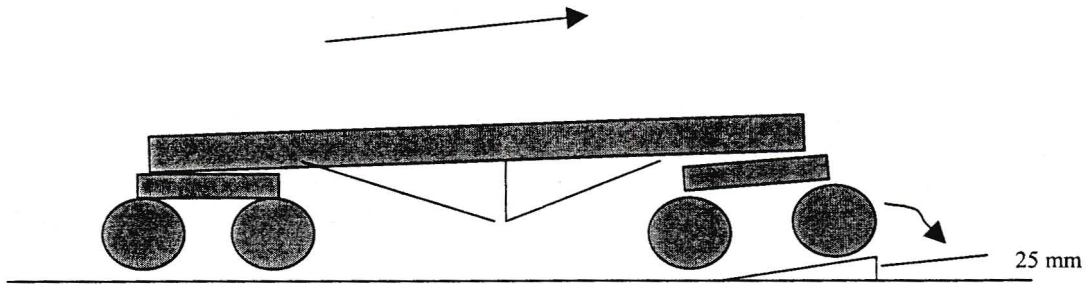

Figure 8.1 Wagon rolling up for drop test

Initially, an attempt was made to roll the wagon up a wedge to elevate the wheel by about 25 mm above the track and drop it onto the track as shown in Figure 8.1. Strain gauges on the web of the track were used to measure the force input.

The force measurement was remote from the deck structure of the wagon. Consequently, this measurement did not isolate the deck as a dynamic entity like a method that applies the excitation directly to the deck of the wagon. Additional problems were experienced in keeping the coherence of the impact signal. Often double bounces were experienced. Attempts to drop both wheels on an axle together also failed as a result of the coherence problems.

8.2.2 Hammer

The next attempt to excite the structure was by striking a reference point on the wagon with a large modal hammer. In this study, the lower frequencies were of interest since the packaging or freight characteristics would prevent transmission of the higher frequencies. For this reason, a soft tip was chosen for the hammer. It was found that, when the medium or hard tip was used, the high frequency modes were excited but very little energy was imparted in the low frequency region where the most interest was focused. With the soft

tip, however, it was not possible to introduce sufficient energy into the structure to achieve usable results. This was especially true under loaded conditions which is why a loaded wagon could not be tested. Attempts to increase the energy content of each hammer blow made it difficult to control the uniformity of motion, and often, double bounces resulted. The impact window used during the acquisition requires a trigger to be set. Vain attempts were made to digitise data recorded from the hammer tests and then use I-Deas for test to apply the impact window and extract the frequency response functions. This would have required specially developed software that could "trigger" on digitised data to apply the data acquisition or impact window. Attention then moved to continuous excitation methods.

8.2.3 Impact from second wagon

Another indirect method of exciting the wagon would have been to roll a wagon into the test wagon. The shape of the excitation pulse would depend on the draw-gears involved in the impact. Resource availability did not allow this mode of excitation to be explored experimentally. Results for the force time and hence frequency characteristics for various draw-gears were available and are presented in Chapter 12 .

8.2.4 Shaker

Continuous excitation of the structure was achieved using a large electromagnetic shaker. The shaker that was available was not suitable for a fully loaded wagon. Consequently, only unloaded tests could be attempted. The controller used could produce white and pink noise. White noise is theoretically a random vibration that imparts equal amounts of energy at all frequencies up to the maximum frequency specified for the signal. In other words, the power spectral density (PSD) of the signal has a constant value up to the specified frequency. The use of pink noise is analogous to using a soft tip in hammer tests. The pink noise signal consists higher energy at low frequencies reducing to the maximum set frequency.

8.3 Comparison of White and Pink Noise Excitation

The power spectral density for the output from the load cell was plotted for white noise and pink noise. This comparison is presented in Figure 8.2.

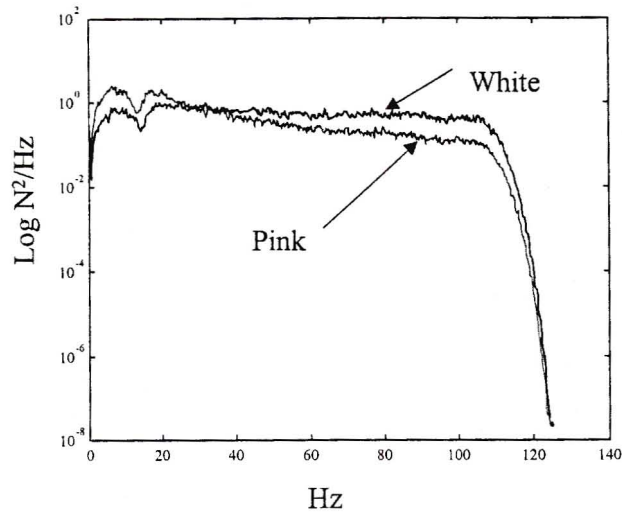

Figure 8.2 Comparison of pink and white noise

The effect of adjusting the amount of energy introduced at low frequency was investigated by superimposing the frequency response function derived from white noise data with that from pink noise data.

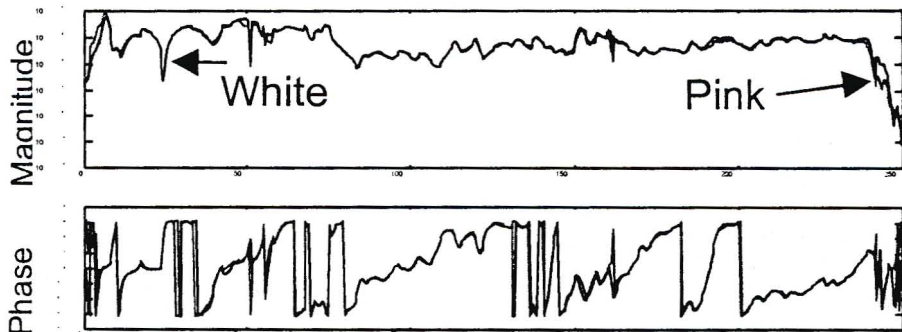

Figure 8.3 Effect of pink noise on Frequency Response Functions(FRF)

Although slight variations occur between the FRF's derived using white noise compared to those from pink noise, these are considered small in comparison to the deviations that are accepted during the curve fitting process from which spectra are synthesised for calculation of the mode shapes. It is also noted that the deviations between the curves are not limited to low frequencies but may also be seen at higher frequencies. It must therefore be concluded that within the limitations of experimental uncertainty and the approximations that have to be made to make allowances for residuals, either white or pink noise may be used for identification of the wagon structure dynamic properties.

8.4 Testing and Test Results

8.4.1 Experimental configuration

The equipment used is listed in Appendix H . Eleven piezzo-electric accelerometers were applied to the wagon in the locations shown in Figure 8.4. Ten were applied near the twist locks and an additional one was applied above the bogie-centre using bees' wax. An electro-dynamic shaker was used to apply an excitation to the wagon below accelerometer number 8 or at co-ordinate 8z.

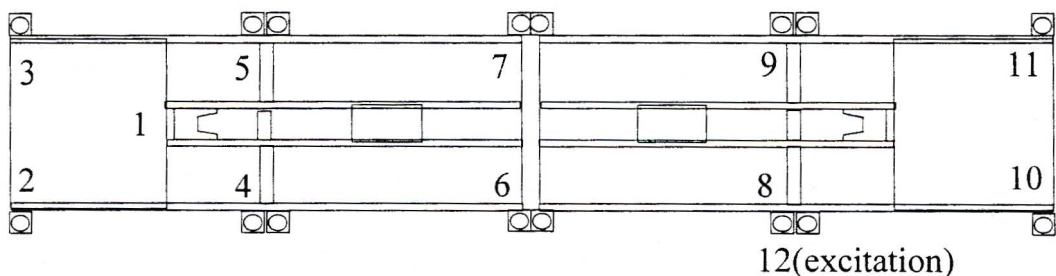

Figure 8.4 Layout of signal channels on wagon

-MODAL TESTING OF WAGON STRUCTURE-

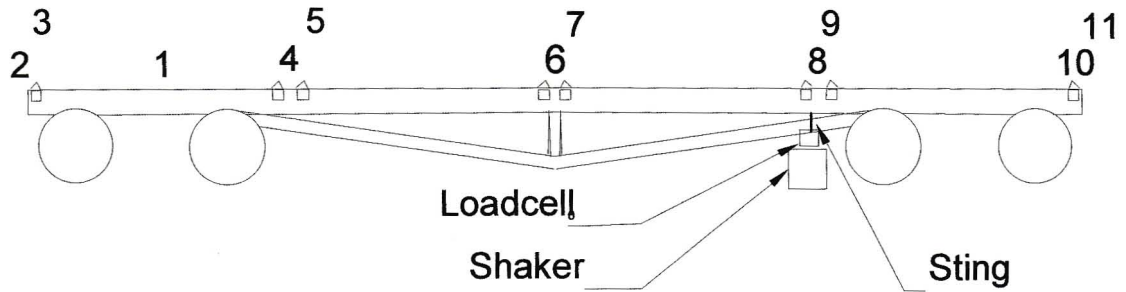

Figure 8.5 Layout of shaker

This was done through a hard wire “sting”. A load cell was mounted between the actuator and the wire as shown in Figure 8.5. The shaker controller generated white noise at 100 Hz which was applied to the shaker. The time signals were recorded on a data tape recorder. A Mausy data acquisition system by McCalc was later used to digitise the signals for further analysis.



Figure 8.6 SHL-5 Wagon ready for application of accelerometers

An arbitrary duration of twenty minutes was chosen for acquiring the data. This was sampled at a frequency of 250 Hz giving a 2.5 ratio between maximum sampling and excitation frequencies. The transfer functions between the load cell and the accelerometers were calculated using Matlab. This gave rise to the eleven frequency response functions, shown in

Appendix A , which were measured between the point of excitation and each of the eleven response points that were chosen.

The Matlab results were then formatted using a Delphi program into the Genrad Universal File Format type 48 so that it could be imported into the "STAR" modal analysis package. The "STAR" package was then used to fit an analytical function to each of the eleven FRF's using the polynomial curve fitting technique. With the response of the eleven points known, "STAR" could then be used to extract the mode shapes.

8.4.2 Results

A typical bending mode is shown in Figure 8.7. The first eight mode shapes are shown in Appendix B .

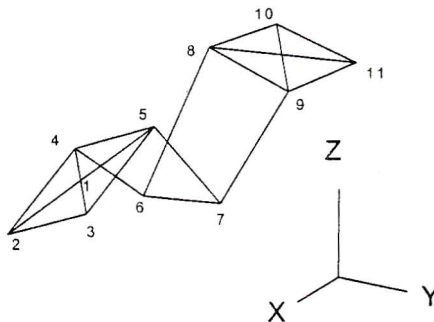

Figure 8.7 Second mode (12.28 Hz)

Most of the modes had some form of twisting possibly with some amount of bending. For the horizontal cylinder, it was the bending component that was of greatest interest. The variable damping of the structure produced a phase difference in the movement of the nodes in a mode shape. This had a possibility of producing a movement that would cause rotation of a vertical cylinder as described in 6.2.1.

Figure 8.8 shows a MAC matrix that was calculated to investigate the relationship between the various modes. Most of the off-diagonal terms are

much less the one indicating that the mode shapes are essentially linearly independent.

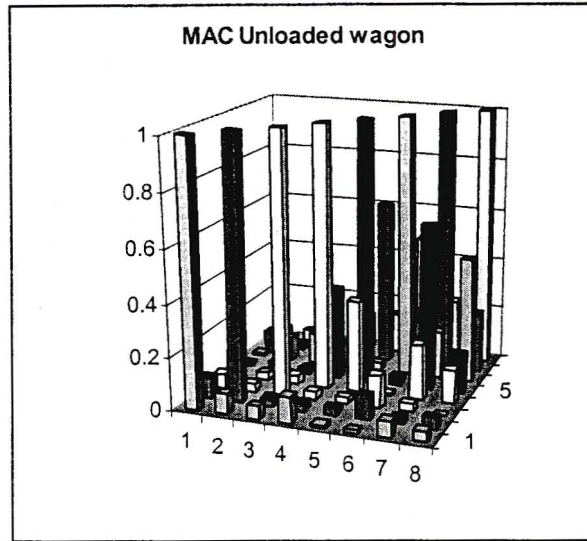

Figure 8.8 MAC matrix calculated for the unloaded wagon

8.5 Introduction of Freight

The influence of the freight on the mode shape of the wagon had to be investigated since it was the mode shape information that would help to identify conditions where shifting of the freight would occur. Areas of high acceleration could also be identified and avoided when protecting fatigue sensitive freight.

The freight itself would add mass and damping to points on the model of the structure. The model may need to be adjusted for these structural modifications. These effects are discussed in Chapter 9 .

The original innovation of introducing of freight, using the established sub-structuring techniques, allowed each of the elements of the freight-wagon system, that is the wagon structure, draw-gear, bogies and freight to be treated separately and then combined to form an integrated system. It would otherwise be necessary to test each configuration before implementing them as approved configurations.

Chapter 9 ADDING FREIGHT TO THE WAGON MODEL

9.1 Introduction

Each of the components of the dynamic system consisting of the excitation through the draw-gear, the wagon structure and the freight has been analysed separately. The objective now is to combine these into a single model to represent the entire system. This new model may be constructed from the finite element model or by manipulation of the modal parameter matrix derived from the experimental data. Although the finite element model has a much greater flexibility regarding the introduction of structures to represent the freight, a correlation procedure is required to make allowances for structural damping and joint properties that were not included in the original finite element model.

A more direct approach would be to use the experimental modal results. The disadvantage of this approach is that the only nodes in the model are those at which measurements were taken. Since the objective is to show whether the mode shape will interact with the stability of the freight, this is not considered a serious limitation provided that measurements are taken at points near where the worst conditions for the freight are considered to be located.

9.2 Structural Modification

The "STAR" software that was used for extracting the experimental mode shapes allows modifications to be introduced in two ways. A mass can be attached to a node, or a spring, or damper can be applied between two nodes, or a node and ground. Although the application of a mass to a node will go some way towards making provision for the mass of the freight on the wagon, this approach ignores the dynamic characteristics of the freight. A

spring to ground does not adequately model the dynamic coupling between the freight and the wagon.

The addition of a dynamic absorber at a node can be accomplished using the software. The freight can be simulated by setting the parameters to appropriate values.

9.3 Freight as a Structural Modifier

The tare of a wagon is in the order of twenty tons. The mass of the freight can be two to three times this. For this investigation, a single 1000 kg mass was added to the model at the second row of twist locks. The mass was split into two lots of 500 kg concentrated at each of the nodes 4 and 5. The software was used to calculate a new set of mode shapes. Strictly speaking, the freight also includes a spring element. An attempt was made to accommodate this by treating the freight as a 'tuned damper'.

The tuned damper is a single degree of freedom element that is attached to a single node. In this case, the coupling matrix, $[K_{sys}]$, in (5.4) becomes a sparse matrix with entries only for the attachment point and the added mass. If there is no damping included the entries would be:

$$k = \pm(2\pi f)^2 M$$

where

f – damper frequency [Hz]

M – mass of damper

(9.1)

The appropriate sign would be chosen for the contribution of the displacement to the coupling force.

9.4 Results from the Application of the Structural Modifier

9.4.1 Pure Mass

The addition of mass alters the shape of the mode slightly. This is demonstrated when the MAC is plotted to compare the shapes of the unmodified structure with the mass modified structure. The diagonal terms for some of the modes are less than one, which would be the case for a perfect match. It can also be seen that some of the off-diagonal terms have increased slightly, indicating only a marginal loss in linear independence of the associated modes.

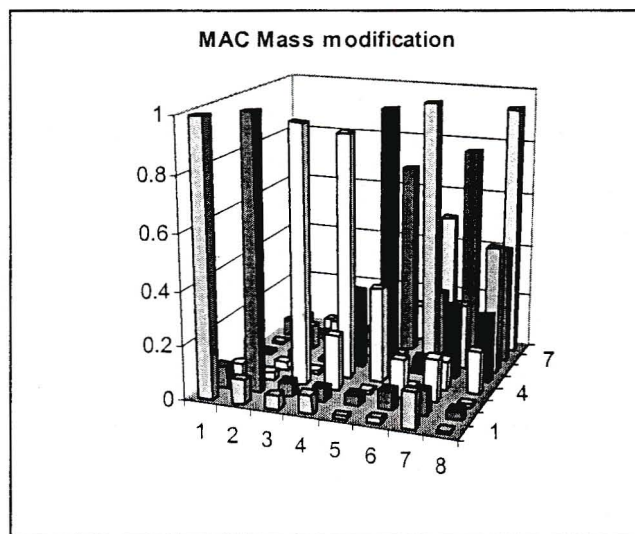

Figure 9.1 Mode shape correlation for pure mass modification

The basic geometrical form of the mode shape has essentially remained consistent for the load case used. Since the freight response was analysed using the shape information, the deflection shape of the unloaded wagon provides useful information. This indicates that the time domain model of the freight constructed using mode shapes for the empty wagon will remain essentially unaltered if corrections were made for the effect of the freight on the wagon modal response.

9.4.2 Tuned Damper

Normally, a tuned damper would be applied to a structure to divert energy from a troublesome mode into the damper. The frequency of the damper would be chosen to correspond to the troublesome frequency. To simulate the freight, the tuned damper facility was used to make allowance for the stiffness characteristic of the freight. The dynamic properties required were the mass, frequency and damping of the modification. The mass of the paper roll was used as in the case of the pure mass modification. The frequency used was chosen at 10 Hz to be close to the natural frequency that was found in the time domain model of the paper roll.

Once again, the mode shapes kept their form. This is verified by the plotting of the MAC for correlation between the mode shapes for the unloaded wagon and the tuned-damper modification. The diagonal terms have remained much closer to unity.

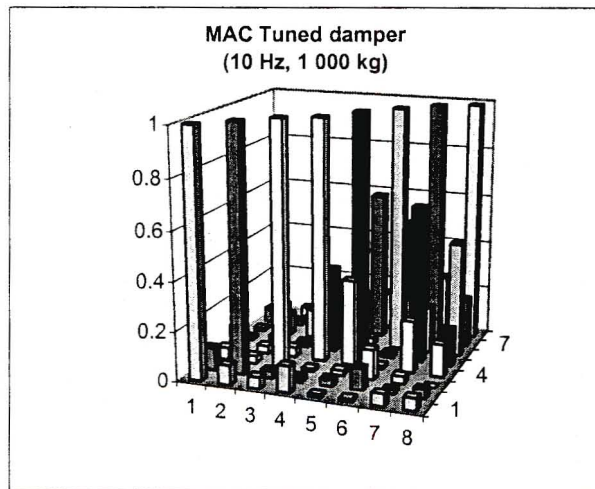

Figure 9.2 Mode shape correlation for tuned-damper modification

It can also be seen that the increase in the off-diagonal terms are not as big as those that were noted with the pure mass modification.

Since the tuned damper represents reality more closely, and the influence of the modification is less, this suggests that a tuned damper approach should be preferred to simply representing the freight as a series of lumped masses.

To investigate the effect of large masses on the mode shapes, the mass introduced was increased to a total of 10000kg. Some of the modes were severely affected as is reflected in the MAC plot. The diagonal terms are no longer close to unity as with the moderate loading. In other words, the model is valid where the magnitudes of the parameters of the modification do not grossly exceed the order of magnitude of the structural parameters.

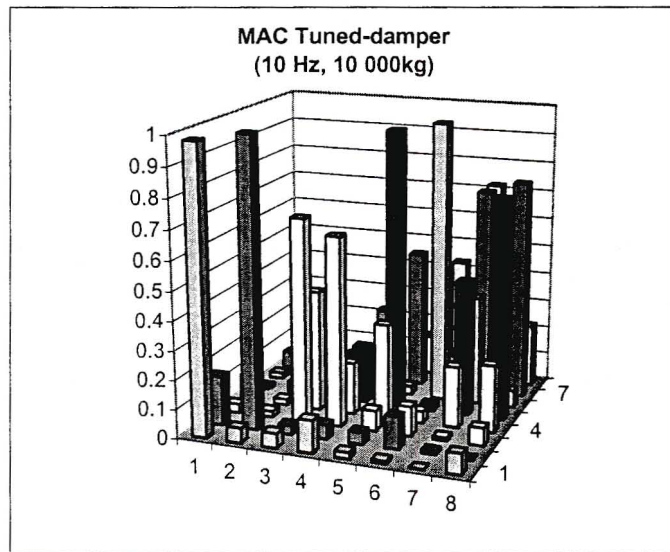

Figure 9.3 Effect of increased mass on tuned damper

It can happen that the natural frequency of the freight is similar to a modal frequency of the wagon so the frequency of the tuned damper was adjusted to the frequency of the third mode, 21.12 Hz, which was the first mode that was primarily bending. In this case, the modal frequencies of the wagon shifted higher by 3.6 Hz when the load was added. Reference to the MAC shown in Figure 9.4 shows that there is only a small effect on the mode shape of the third mode. Higher modes have been affected, however.

If the resonant condition is excited simultaneously with a horizontal acceleration then load shifting and scuffing damage may result. The resonant condition is far more critical where the commodity is susceptible to fatigue damage. The larger displacements will be associated with higher stresses and hence greater fatigue related deterioration.

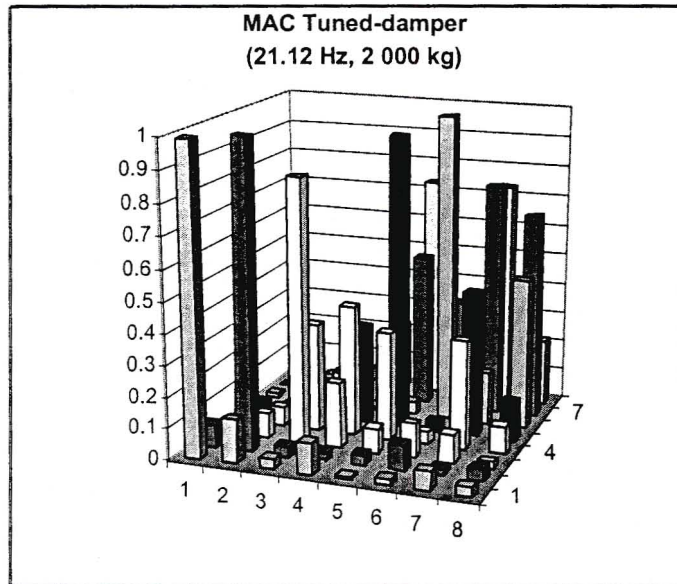

Figure 9.4 Effect of resonant damper

9.5 Comparison of mode frequencies

Table 9.1 lists the frequency measured for each mode and compares it with the calculated frequency after modification.

The addition of pure mass to the system has the anticipated result of decreasing the frequency of the mode. The effect of the tuned damper, on the other hand varies from decreasing the mode frequency slightly through no effect at all to slightly increasing the modal frequency.

Table 9.1 Mode frequencies – measured and synthesized

Mode	Unloaded	Mass 1 000 kg	Tuned- damper 10 Hz, 1 000 kg	Tuned- damper 10 Hz, 10 000 kg	Tuned damper 21.12 Hz 2 000 kg
	Hz	Hz	Hz	Hz	Hz
1	4.56	4.53	4.67	5.15	5.02
2	12.28	11.97	12.46	13.63	12.92
3	21.12	17.90	21.98	25.52	24.71
4	26.44	26.13	26.54	29.39	27.92
5	35.28	33.58	35.43	36.59	36.32
6	38.74	38.70	38.75	38.79	38.75
7	41.90	40.27	42.08	43.11	43.06
8	43.38	43.26	43.41	44.93	44.63

Even when high masses were used as a tuned damper this had very little effect on the mode frequencies. In other words, the modal frequencies of the empty wagon serve as a very good guide to the frequencies that can be expected in the loaded wagon.

9.6 The Loaded Wagon

Although there were minor deviations, when moderate loads were used, from the mode shape derived from an unloaded wagon, it will still form a sufficiently good basis for the geometry input to a time based freight model. The change in frequency is small and would probably be less than the errors introduced when estimating the freight dynamic properties and wagon mode shapes.

Chapter 10 FINITE ELEMENT SIMULATION OF WAGON MODE SHAPES

10.1 Introduction

As a starting point it was decided to produce a finite element model of the wagon structure. An SHL-5 was chosen since a stripped down version was available for experimental work. Several authors (Ewins, 1988, for example) and software houses (SDRC and Genrad, for example) have published methods of introducing structural changes into experimental models by modifying the modal matrix. Provided that the test points are chosen to correspond to the points where the modification will be applied, it would be adequate to use the experimental model. If the modification were to be applied at other points, then a finite element model would have to be tuned to reflect the data acquired from the experimental model and the modification applied to the finite element model.

This chapter describes how an SHL-5 wagon was modelled using finite element techniques. This model served as an indicator of how the actual wagon could be expected to deflect thereby allowing time domain models of the freight to be constructed as described in Chapter 6 . It should be noted, however, that no damping was used in the models. The effects of the damping can be seen in Chapter 8 , hence the decision to use experimental modal results wherever possible.

10.2 Modelling Philosophy

A wagon is made using riveted joints and welds. This means that the joint characteristics are somewhere between those of a pin joint and rigid joint with an amount of structural and Coulomb damping. Without analysis of the joints themselves, it is not possible to assess the exact effect of each joint.

Each joint is fixed with several rivets allowing a sizeable moment to be transferred. Consequently, a fixed-jointed model was used.

10.3 System Resource Limitations

The model was built on a μ VAX using I-Deas software. At first, attempts were made to represent the wagon by a complete set of plate elements. This was to allow modelling of gussets and complex changes in beam profiles in areas where fabricated beams were used. The number of elements resulting from the model exceeded memory limitations and resulted in considerable virtual memory usage. The model would then take several days to solve. To facilitate a solution, the long sections were replaced with beam sections.

10.4 Boundary Conditions

Since the intention was to analyse the interaction of the freight with the wagon, the rigid-body modes should not be removed from the model, since freight interacts with the motion of the surface and not specifically with the bending or torsion of the structure.

The stiffness of a spring cluster was calculated using the material diameter, spring diameter, and number of turns of each spring acting in parallel. The stiffness was placed at each bogie centre.

10.5 Model Solution

The solver that was bundled with I-Deas (from SDRC) was used to analyse the model. Several solver options for solution methods are available. 'Simultaneous Vector Iteration' was chosen for this purpose to avoid excessive virtual memory access on the micro-VAX used for the model. This is outlined in 4.5.2.

The mode shapes for one of the rigid-body modes and the first three torsion modes and the first two bending modes are shown in Appendix C .

10.5.1 Rigid Body Modes

The first mode identified was a rigid body roll mode. This occurred at a very low frequency and probably would not be significant even when combined with other effects such as slack sections of track.

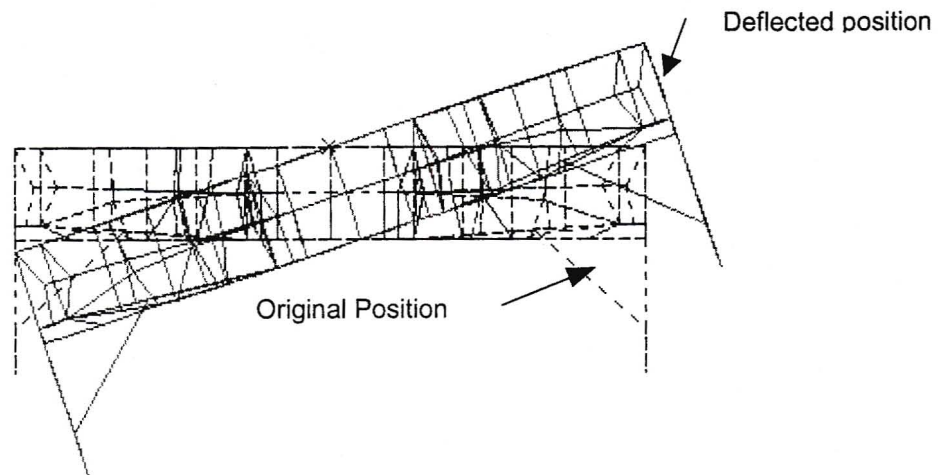

Figure 10.1 First rigid mode 0.004 Hz roll

10.5.2 Flexible Modes

A twisting mode was found in the frequency range close to the natural frequency of freight-packaging combinations. Twisting modes can cause shifting of the freight, especially if there are two modes acting close together. Other problems that they may cause include fatigue damage and false-brinnelling effects in bearings.

The finite element model does not include damping effects. Consequently, there is no phase difference between the nodes in a mode shape. On the real structure, these damping effects can cause the normal to the surface to move so that it favours rotation of freight.

-FINITE ELEMENT SIMULATION OF WAGON MODE SHAPES-

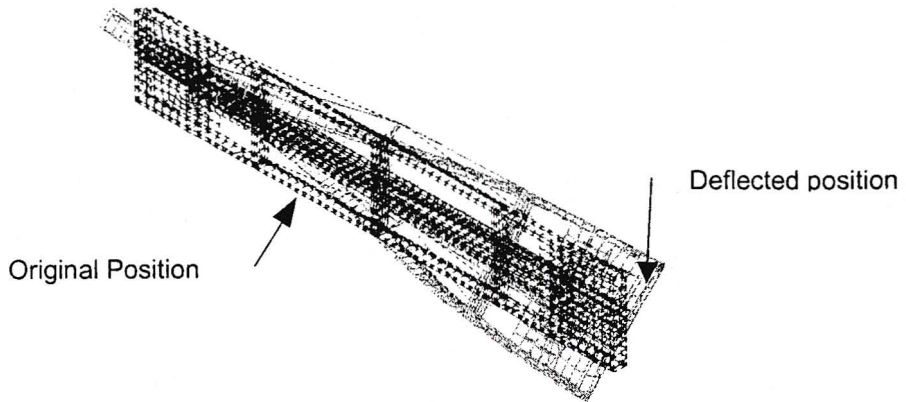

Figure 10.2 First torsion mode 5.33 Hz

The second torsion mode at 31.29Hz and third torsion mode 51.68Hz are shown in Appendix C . These represent additional frequencies at which resonant interactions between vehicle and freight may occur. It should be noted that the finite element analysis showed these modes of vibration to be pure torsion whereas the experimental results, discussed in 8.4 , showed a combination of torsion and bending. This was attributed to the use of rigid joints in the finite element model whereas the wagon had a riveted structure which would have give greater flexibility to the joint.

10.5.3 Bending Mode

The first pure bending mode was found at a relatively high frequency on 24.3 Hz. The bending mode was of particular interest as input to a model for a horizontal cylinder.

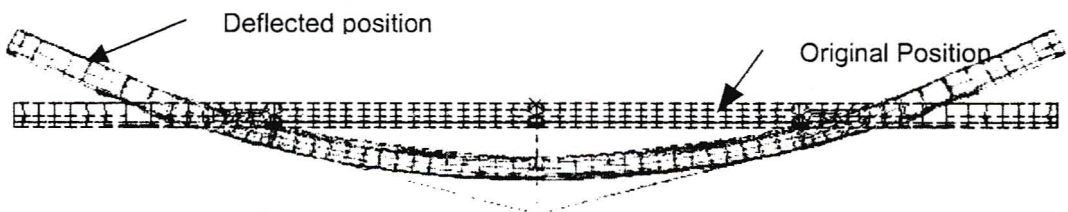

Figure 10.3 First bending mode 24.3Hz

The second bending mode at 32.53Hz is shown in Appendix C . As indicated in 10.5.2, the additional frequencies are frequencies at which resonant interactions may occur.

10.6 Discussion of Results

The finite element analysis has shown the basic form of the mode shapes that can be expected. The shapes extracted from the model are shown in Appendix C . The shapes can be used as geometric input into a freight model. It must be noted, however, that the model does not include any damping. This would translate into different phase relationships between nodes in the real structure. The effect of joint properties and position of excitation source may also result in an amount of torsion being introduced into a predominantly bending mode and bending into a torsion mode. This, together with the altering of the phase relationship by damping, could produce the rotation effects that would cause freight to shift. This effect would not be evident from the FE shapes.

The damping of the structure would also cause small shifts in the modal frequency. Since each load differs, these effects will be small in comparison to the variation in dynamic characteristics of the load.

It was not possible to perform the correlation exercise between the finite element results and the experimental modal results. A visual inspection, however, shows that the finite element results exhibit pure bending and pure twisting modes whereas the experimental results are all combinations of twisting and bending in various degrees. The reason for this is that factors such as joint stiffness and bending were excluded from the FE model. Problems in accuracy can also arise from the number of adjacent plate elements used to form a beam. For these reasons, it was decided that the experimental modal results would be more useful for the current research. If finite element is to be chosen then a model refinement procedure would be recommended.

Chapter 11 FREIGHT PROPERTIES AND FREIGHT DYNAMICS

11.1 Introduction

Most freight protection specifications require the item to be dropped from a specified height at various angles. This simulates the handling of the goods in the shed. It fails to take the transfer characteristics of the vehicle components into account. Savings can be made if care is exercised during the handling of the goods. This saving can be achieved if more is known to characterise the protection of the goods in the dynamic environment that the vehicle produces. It is this somewhat less severe dynamic environment for which the freight protection can be designed.

Models to predict freight behaviour require certain characteristics of the commodity to be known. Properties such as mass and length are easily measured. In the case of stiffness and damping, approximate values need to be determined. Once these properties are known, a model to determine the dynamics and possibility of failure of a specific commodity may be constructed.

Depending on the commodity, it might be appropriate to provide a small excitation to the package and measure the response of item inside. For other commodities, a simple drop test may be sufficient to determine the transfer functions.

Since transport of bulk paper rolls was topical, most of the work was done to characterise the one ton rolls. The method chosen was to measure the stiffness under near static conditions. Although there would be some speed dependence in the parameters obtained, it was reasoned that other approximations employed in the modelling of the freight would contribute more to the deviations of the model from the real system.

This chapter serves as an application and simulation of the concepts developed in Chapter 6 .

11.2 Dynamic Strength

11.2.1 Drop testing

The simplest method to test the strength of products is to use a drop test according to a specification such as ASTM 3332. The item is released from ever-increasing heights and dropped onto a hard surface. The item is then examined for damage. The package needs to be dropped on all possible sides and corners to pass the test. It can then be rated for certain shock conditions. Gorman (2000) points out that, to test a simple rectangular package, it would require twelve samples of the commodity. For a valuable package, the cost of the samples may far exceed the possible savings that can be made in packaging. In the case of low cost with high volume commodities, however, the savings on packaging and warehouse space may well justify the test.

Gorman goes on to say that a substitute can be used for the product. This can be made from any material that will give an equivalent mass distribution. In this case, however, it is essential to know something about the strength of the product itself. It also becomes necessary to measure the accelerations experienced by the product when it is protected by the packaging.

In this type of test, only one condition is tested, namely the impact with a hard surface. No account is taken of the duration of the pulse that the package may experience. Some advantage may also be achieved by designing for the vehicle dynamics and eliminating rough handling of the package.

11.2.2 Fragility index

The probability of damage to freight depends not only on the magnitude of the acceleration but also on the duration. Damage can result from a short high amplitude event or a longer, lower amplitude acceleration. Contrary to a comment made in the internet discussion group, Packtalk (1997), a point is reached where the pulse is too narrow to transfer the force and energy to cause damage. If the amplitude of the acceleration pulse is low enough, the static strength of the freight will not be exceeded and no damage will occur. This concept is known as fragility index or the damage boundary.

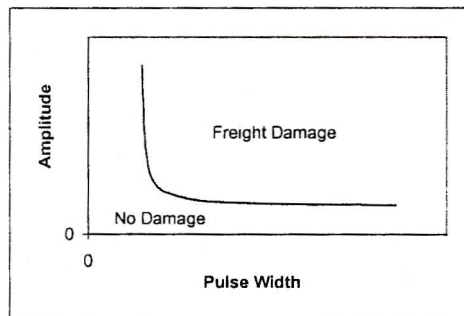

Figure 11.1 Typical Fragility index Curve

Fragility index is measured by placing the item concerned on a sled. This sled is then accelerated into impact actuators. The magnitude of the pulse and the pulse width can be manipulated by changing the pressure in the actuators, the number of actuators and the velocity of impact.

This test is considerably more expensive than the drop test since a much larger quantity of the item concerned will be required to derive a reasonable form for the curve. The apparatus required is also far more complex.

11.3 Stiffness characteristics

The construction of a model representing the dynamic interaction of freight and the vehicle requires estimates of the dynamic properties of the freight to

be known. Ideally these should be determined using a shaker test. When the mass of the item reaches 1000kg, the size of the shaker required is only in the reach of the largest laboratories.

11.3.1 Compression Test

To determine the characteristics of a paper roll, the compression test described in 2.2.2 was used. The roll was placed in a press that was fitted with a load cell and a displacement transducer. The force-displacement curves were acquired and plotted. If it is assumed that the mass of the roll can be lumped at the centre of a horizontally loaded cylinder, then the roll essentially constitutes two springs acting in series. Although the stiffness and hysteresis characteristics are probably speed dependent, the testing for this effect was beyond the scope of the equipment available and was consequently could not be included in the model that was developed. The increase in hysteresis loss would improve the conditions for the freight and the error would be on the conservative side. The disadvantage, however, was that no account was taken of the frequency effect that changes in damping may have had.

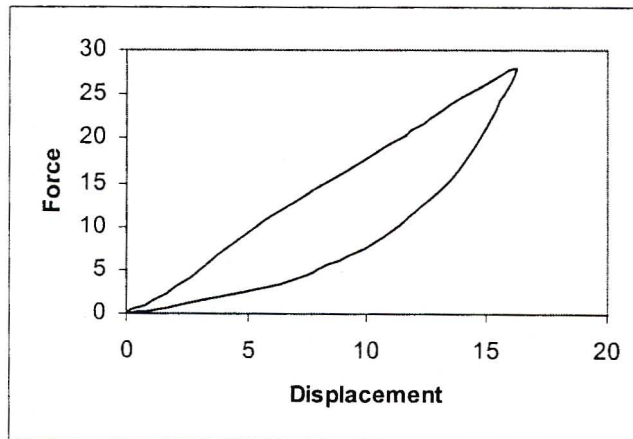

Figure 11.2 Typical Curve for diametrically-loaded cylinder.

It was found that the stiffness on the compression stroke was nearly linear.

On the expansion stroke, however, the force lagged behind the displacement as can be seen in Figure 11.2. The area between the two curves represented the energy absorbed by the paper during the cycle. Although the deviation of the curve would be dependent on the speed, this effect had to be ignored owing to limitations of the press.

The stiffness for the entire roll was measured as 2000 kN/m in the compression stroke. A hyperbolic sine function of the form shown in (11.1) was used to fit the data on the expansion stroke. The optimum constant to match the curvature in the data, 3.5, was found using a successive approximation approach.

$$F = F_{\max} \frac{\sinh(ax / x_{\max})}{|\sinh(a)|}$$

where

F = Force on roll

F_{\max} = Maximum force

x_{\max} = Maximum displacement

a = Shape factor

(11.1)

A similar test was done for an axially loaded paper cylinder the result of which is shown in Figure 11.3. In this case, however, the significance of the curve shape must be examined carefully.

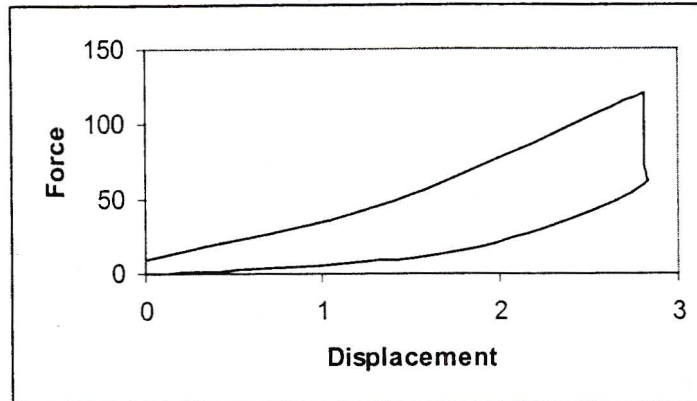

Figure 11.3 Typical curve for axially loaded cylinder.

Typically there will be a vertical component acting through the centre of the roll. This results from the vertical displacement of the surface. Superimposed on this there will be an edge loading resulting from the twisting of surface. In this case, displacement increases uniformly from the centre of the roll to the outside and the effect of the stiffness needs to be calculated accordingly.

11.3.2 Drop Test

Using a procedure similar to that for extracting the modal parameters from a structure, the frequency response functions can be extracted from the freight. The damping component however will be much higher and application of sufficient energy can be difficult. For this reason, a drop test instead of a hammer impact may be chosen. The surface on to which the item is dropped has to be configured to act as a load cell. Accelerometers mounted in the commodity measure the dynamic response. This approach takes some of the speed dependence into account but is nevertheless carried out at a single condition, which will be different from the frequencies experienced during transit and would probably not be totally representative of the true situation.

11.4 Dynamic Model of a Horizontal Resilient Cylinder

11.4.1 Material Properties

Paper is transported in rolls of approximately one ton. The rolls are about 600 mm diameter and 800 to 1000 mm long. Owing to the size of the roll, the compression test approach was chosen. The radial compression test results were used as estimates for the material properties.

11.4.2 Computer Model

The roll was modelled as a horizontal cylinder on a beam as described in 6.2.1. The program code is shown in Appendix G . The natural frequency based on the compression stiffness curve and the mass of the roll was calculated. It should be noted that in the compression test, the roll acts as two springs in series whereas when the roll lies on a surface, only one of the springs is "active". The stiffness derived should therefore be doubled.

The beam provided the excitation by pivoting about a point at the node point associated with the mode.

When no slipping occurred, the roll was assumed to rock at the same angular frequency as the beam. At the same time, the beam provided a vertical excitation into the roll.

The roll was considered to have slipped when the torque required exceeded the friction resulting from the contact force between the beam and the roll.

At frequencies below the natural frequency of the roll, the roll essentially follows the movement of the beam as can be seen in Figure 11.4. Although the amplitude is less for the roll than for the beam, the phase relationship is such that no slipping occurs.

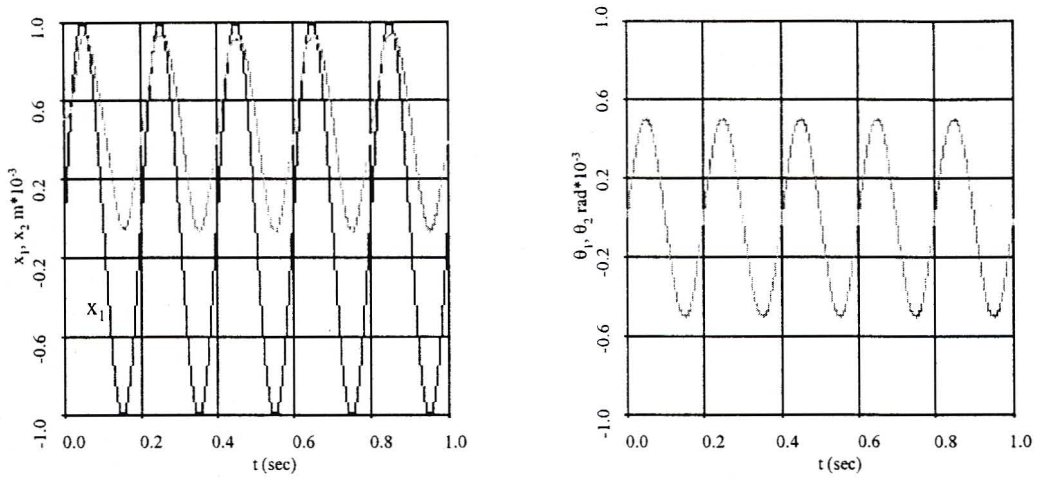

Figure 11.4 Vertical (left) and rotational (right) response at 5 Hz

When the frequency approaches the natural frequency of the roll as in Figure 11.5, the “beating” effect, which is expected for near resonant systems, is evident. The phase relationship is still such that no slipping occurs.

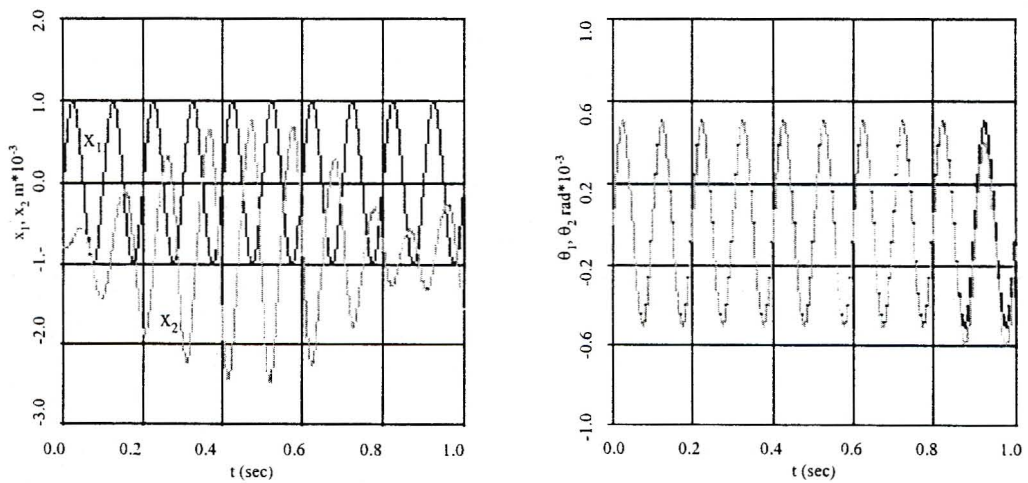

Figure 11.5 Vertical (left) and rotational (right) response at 10 Hz

At frequencies higher than the natural frequency of the roll as in Figure 11.6, the phase is such that considerable reductions in normal force and hence

available friction occur when the torque demand to accelerate the roll is maximum. This readily allows the roll to rotate.

It can be seen that the properties of the freight had a definite effect on how it would respond in transit. If the wagon vibrates at a frequency above the damped natural frequency of the roll there is a chance that it will rotate.

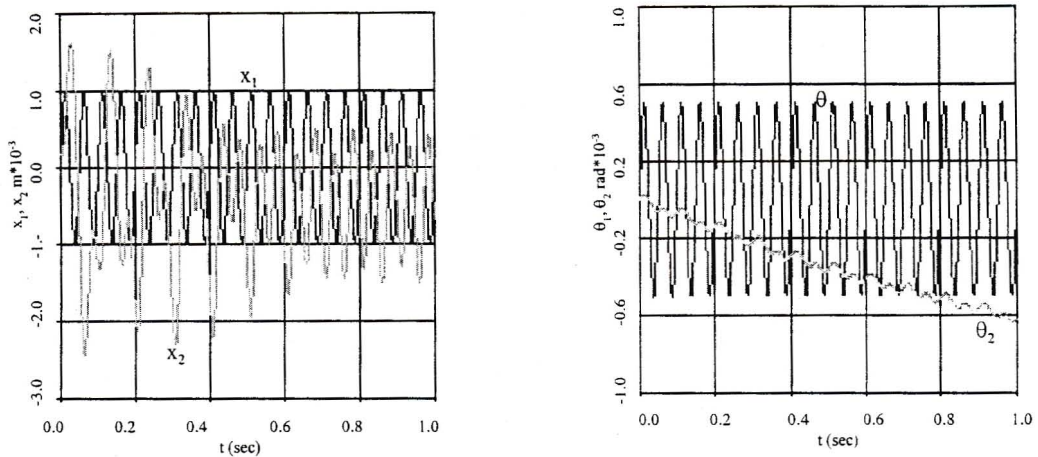

Figure 11.6 Vertical (left) and rotational (right) response at 20 Hz

11.4.3 Conclusion

The simulation of the horizontal paper roll showed that movement of a paper roll is not only caused by rough shunting of the wagon but may also occur in transit due to interaction of the vibration of the wagon and the geometry of the freight. Identification of this effect is an original contribution to the understanding of the problems encountered in the transport of resilient cylinders.

Chapter 12 DRAW-GEAR INFLUENCE

12.1 Introduction

The width and shape of the force pulse resulting from an impact depends on the material and configuration of the damping element. An all-steel draw-gear has a narrow curve whereas an elastomeric draw-gear is tailored to transfer to force in a pulse of lower amplitude but longer duration. The mechanism of each gear is described in 7.3.1.

Some of the results measured from draw-gear characterisation work are presented here. An original extension of the interpretation of the data and the work done by Dutton (1990) from the time domain into the frequency domain is given in 12.3.3. It was also shown that similar interpretations of pulse width, shape and magnitude could be made in the frequency domain as in the time domain.

12.2 Test Description

12.2.1 Apparatus Description

Two draw-gears of the type under test were fitted to a pair of wagons. The one wagon, the hammer, was winched a short distance up a ramp and released. The height was chosen, based on previous experience, so that the impact speed was approximately 1 m/s, 2 m/s or 3 m/s. The hammer wagon was then released and allowed to run into the second wagon, the anvil. The anvil wagon was either standing free on its own (SF) or it was standing solid (SS) against a string of weighted wagons.

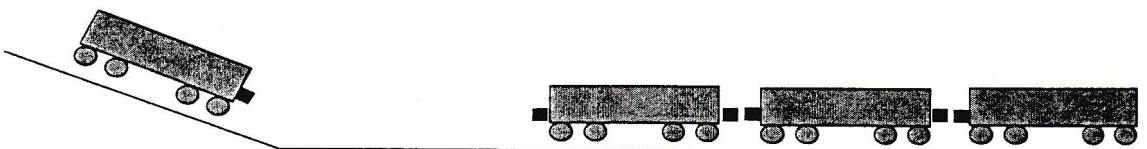

Figure 12.1 Configuration for SS test

12.2.2 Instrumentation

Displacement of the draw-gear was measured using linear voltage differential transformer (LVDT). The coupler shank was machined and fitted with strain gauges connected to compensate for temperature and bending to form a load cell.

The signal was amplified and stored on a magnetic tape for later play back. A data acquisition computer fitted with anti-aliasing filters was used to digitise the signals for analysis on a personal computer.

12.2.3 Data Analysis

The impact signals were identified based on a threshold displacement signal using a simple utility coded in Matlab. The sample frequency was 125 Hz so that the force pulse width of 20 ms could be adequately measured. Examination of the wave forms showed that they fitted conveniently in a 32 line window. The power spectral densities could be calculated by specifying no overlap of signal windows using a 32 line window. The default Hanning window option was used.

12.3 Results

12.3.1 Time Domain Wave Forms

12.3.1.1 All Steel

A Crown SE and an XK25 all steel gear were mounted in turn in the anvil wagon. The hammer wagon was fitted with a solid spacer. This was done to avoid interaction effects between draw-gears.

The all steel gear relies on the friction characteristics of the shoes for energy absorption. A metal surface rubbing on another will tend to stick until static friction is overcome and then slip a short distance to relieve the forces. At this point the surfaces stick together and the process is repeated. In other

words, the basic closure curve has a higher frequency stick-slip curve superimposed on it.

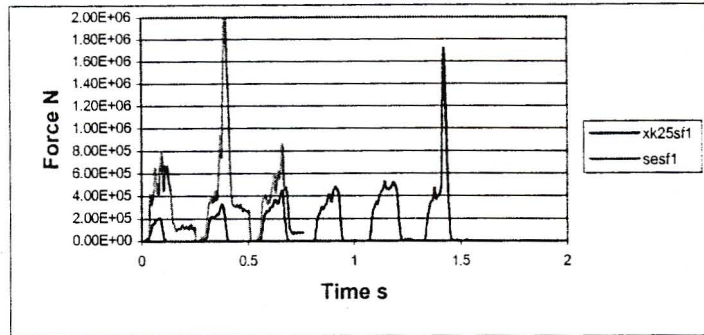

Figure 12.2 Force traces obtained from all steel gears

The stick-slip characteristic can be clearly seen in the time trace for both the gears. Newcomer (1959) comments that the frequencies resulting from stick-slip can be in the order of 600 cps and that this would be of interest in fatigue evaluations rather than freight evaluations because freight is unlikely to respond to these high frequencies. The spikes that can be seen are at a frequency in the order of 60 Hz. These gears tend to have a relatively long rise time and force release time. In some places, the draw-gear has been compressed by its entire stroke causing a rapid rise in the force when the coupler runs solid against the wagon frame.

12.3.1.2 Rubber – friction

The rubber friction draw-gear, such as the Miner SL-76 used for this test has friction pads to absorb the impact energy in a similar manner to the all-steel gear. The difference is that a stack of rubber pads is used in place of the steel spring. The rubber provides additional damping, consequently the stick-slip is not as severe.

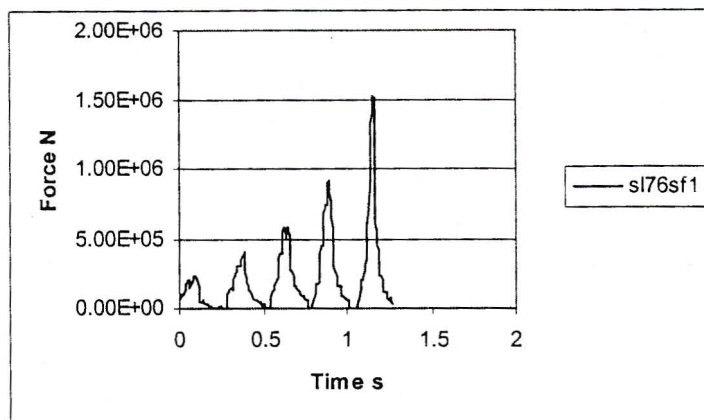

Figure 12.3 Force trace for a rubber-friction draw-gear

As with the all-steel gear, the force profile exhibits a relatively long rise and decay time. The stick-slip spikes, however, are not present, eliminating the higher frequency inputs into the wagon structure.

12.3.1.3 Hydraulic

The principle of operation of hydraulic gears is different to that of spring-friction gears. The energy is absorbed by forcing hydraulic oil through an orifice. The rate at which the gear can absorb energy and the resisting force are therefore strongly speed dependant. Introducing a profiled pin that moves with the stroke of the gear can vary the area of the orifice. In this way, the manufacturer can customize the force-displacement characteristics of the gear. Attempts can also be made to reduce the peak force by increasing the width of the force pulse.

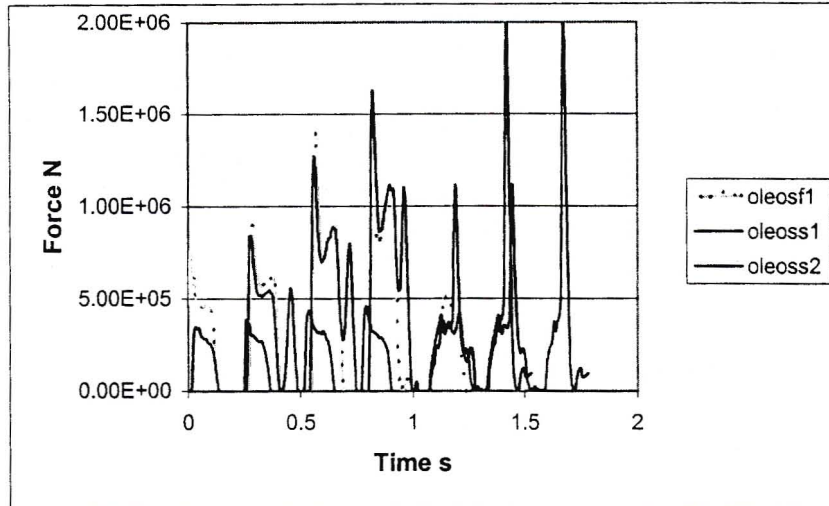

Figure 12.4 Force time trace for hydraulic draw-gear

In most of the cases, a narrow force spike can be seen. This is indicative that the draw-gear ran solid at that stage. The pulses are reasonably wide reducing the amount of energy in the higher frequency ranges thereby protecting the freight from shifting.

12.3.2 Frequency Domain Analysis

The power spectral densities for several draw-gear types used in the standing free and standing solid configurations were derived from impact data and are presented in Figure 12.5. In all of the gears, a high energy content in the zero to eight Hertz range was noted. At eight hertz, the energy content dropped to a new level, which steadily decreased with increasing frequency. As mentioned in 12.3.1.1 the all-steel gear tended to introduce higher frequencies as a result of the stick-slip characteristic. This can be seen in the curve for the Crown SE draw-gear. The Miner SL-76 also shows this trend to some extent.

The Oleo, hydraulic draw-gears do not have such a marked decrease in value at eight Hertz and show a much lower high frequency content as well. It was noted in the freight dynamics study in 11.4.2 that inputs above

resonance, that is the higher frequencies, had the propensity to cause freight shifting. Consequently, a system that avoids high frequency input is less likely to cause freight to move in transit.

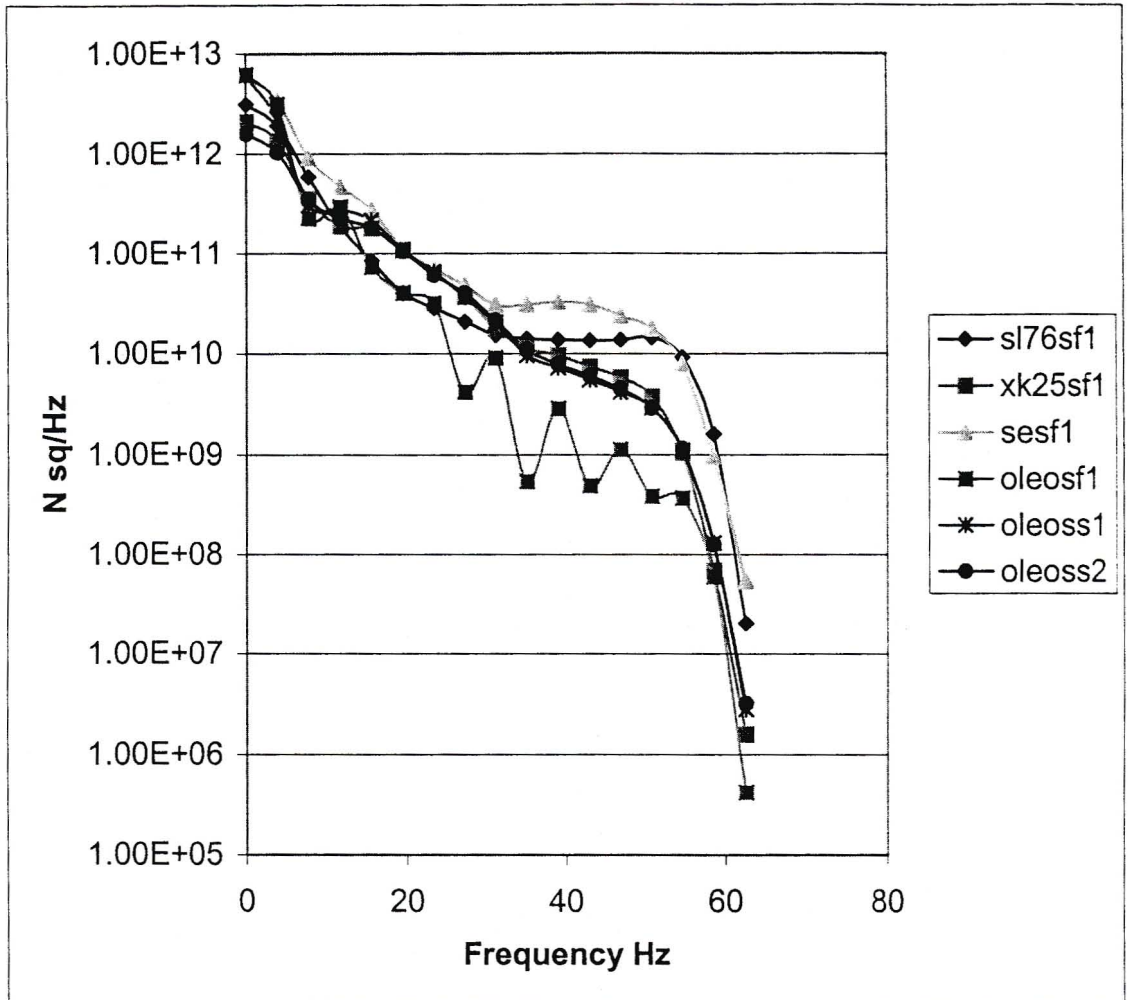

Figure 12.5 PSD for various draw-gears

12.3.3 Relative Performance of Gears

In the investigation of freight movement in 11.4 , it was noted that the higher frequencies are likely to cause shifting of freight. In other words, draw-gears that exhibit lower PSD values at higher frequencies such as the hydraulic gears and the XK25 and similar gears with a smooth action should be

considered for protection of general freight. Certain applications require a sturdy, high strength draw-gear element. Even in these cases, train handling and in-train forces can be detrimentally affected by the shocks introduced by stick-slip.

It must therefore be concluded that a smooth-acting draw-gear has advantages in both the train handling and freight protection areas.

Chapter 13 CONCLUSIONS AND RECOMMENDATIONS

13.1 Summary

There is always a trade off between the cost and the results that may be achieved. If sufficient money is spent on packaging, any commodity can be protected from most conceivable forms of damage. Since the cost of over-protecting commodities is high and will be detrimental to their marketability from the financial point of view, the solution must lie in giving more attention to transport design techniques.

This work gave attention to each of the physical components that contribute to the dynamic behaviour of goods. It is this dynamic behaviour that determines the potential for damage to occur during transit.

The packaging provides a dual role in the protection of goods. It provides a barrier that will prevent abrasion and scratching of the product. A second purpose is to modify the dynamic and vibration environment generated by the vehicle in such a way that the chance of damage is minimised.

The dynamic characteristics of the wagon structure contribute to the shocks and vibrations that are transmitted to the freight. The nature of a flexible structure is to respond to- and transmit certain frequencies in preference to others. If it happens that the critical frequencies of the freight match those of the wagon, accelerated damage may result.

The wagon itself receives its inputs from two sources. The track effects are transmitted by the bogie and suspension elements. Other authors have dealt with bogie and wheel dynamics in detail so little attention was given to this area. Train action forces are transmitted to the wagon via the coupler and then the draw-gear. Since the draw-gear's function is to absorb energy

through its force-displacement characteristics, it will also favour the transmission of certain frequencies in preference to others.

Each of the components contributes to the total dynamic system. The wagon structure was analysed using experimental modal analysis techniques. The motion of the freight was analysed in the time domain. Its contribution to the system dynamics was added using the modal analysis software. Bump test data were used to investigate the force spectrum characteristics of the draw-gear.

13.2 Freight

The main concern when designing a freight transport system is the prevention of damage. The damage may result from surfaces rubbing together causing chafing of the surfaces. False brinelling in bearing results from the rolling elements moving in an oscillatory motion, wearing a depression in the race. Fatigue may result from repetitive strain of a section such as a spring or shaft. Plastic distortion or fracture may occur from a single dynamic event.

For frequencies below the resonant frequency of the freight, the freight will vibrate in phase with the wagon. Under these conditions, the resulting damage will be internal, that is, fatigue and false brinelling effects. If the frequency is above the resonant frequency of the freight, the wagon and freight vibrate out of phase. This results in a reduction of force between the friction-coupled surfaces. In these cases, slipping may occur. The shape of the vibration mode may be such that it aids the shifting of the freight. This illustrates the objective to show that there is a relationship between the dynamic characteristics of the freight and the possibility of damage. It also indicates the usefulness of freight models developed in identifying possible problem areas in loading patterns.

13.3 Wagon

The wagon is a structure made from beams and plates. A structure like this can possess many mode shapes. The influence that the shape has on the freight depends on the geometry of the configuration. If cylinders are laid horizontally, then a bending mode may cause rotation of the cylinders. Torsion modes can cause rotation of vertical cylinders.

Only small changes to mode shape and modal frequencies of the wagon occurred when freight was introduced into the modal model. This simplifies the approach for composing a lading model in that the freight can be analysed in the time domain using the modal information for the empty wagon. Small corrections may need to be made to the modal frequency for critical applications. This shows that each component may effectively be modelled separately and combined into a single model. Since the influence of freight on the modal model was small, the effect of linearising the hysteresis and similar coupling elements between freight and wagon should not have a significant influence on the accuracy of the final result.

13.4 Draw-gear

The draw-gear transmits forces to the wagon structure. These forces may arise from shunting activities and from train action. Analysis of data from impact tests showed that the gears tested transmitted most of the energy in the 0 to 8 Hz frequency range. Gears that exhibited stick-slip characteristics also introduced higher frequencies into the force input, that is, in the 40 to 50 Hz range whereas the smoother acting gears did not transmit large amounts of energy in this range. Those draw-gears that had narrower force pulses also introduced some of the higher frequencies into the structure in addition to higher force levels.

If a freight configuration is sensitive to higher frequencies, then a draw-gear that does not transmit the higher frequencies should be chosen.

13.5 Complete Dynamic System

Each of the components of the wagon-freight system or even the train as a whole, contributes to the dynamic environment in which the freight must be protected. Use of sub-structuring techniques allows the system to be broken into portions that can be solved and added together into a model that reflects the entire system. An understanding of the components and their interaction allows the optimisation of freight and packaging to minimise damage in transit. If rail is to be an attractive transport alternative, then close attention must be given to freight dynamics and damage prevention.

With the sub-structuring approach a database of characteristics of wagons, bogies and draw-gears can be constructed. Freight properties can either be supplied by the client or from an in-house laboratory. Combining this information using the techniques discussed will facilitate the selection of the most cost effective combination of packaging, draw-gear and other protection devices for a specific service.

13.6 Original Contributions

The following original contributions to the area of freight transport dynamics were made:

- Several models for the analysis of freight behaviour were proposed.
- A computer model was constructed of a horizontal paper roll. This model showed that conditions can exist where a roll will rotate in transit causing damage to itself.
- The computer model also showed that frequencies above resonance may be associated with shifting of freight since this reduces contact forces between the freight and the wagon.

-CONCLUSIONS AND RECOMMENDATIONS-

- The draw gear introduces a broad band of frequencies into the wagon. Lower grade draw gears not only introduce higher amplitudes of acceleration but also introduce higher frequencies into the wagon.
- The wagon could be subdivided into its components for dynamic analysis. For reasonable magnitudes, the characteristics of the unloaded wagon could be used to estimate the dynamic environment that would be experienced by the freight.

The analysis of the freight-wagon dynamic system was extended to the frequency domain. This opens the way for the entire wagon system to be studied as an integrate whole.

Chapter 14 FUTURE WORK

14.1 Horizontal to Vertical Transfer Function

In this research, the horizontal input from the draw-gear was simply taken as a frequency input into the structure. It was assumed that it would excite the modes with the same frequencies as the excitation. It would be useful to make resources available to perform the instrumented impact tests necessary to determine these transfer functions.

14.2 Verification of Model using Operational Deflection Shapes

Owing to resource constraints, it was not possible to perform tests within the train to derive the final confirmation of the model. These tests would involve instrumenting a wagon and then coupling it to a train. This data may then be used for deriving operational deflection shapes (ODS). These should be similar to the mode shapes derived from the shaker tests.

An ODS would also need to be derived from a wagon loaded with freight of known dynamic properties. These shapes may then be used to verify the results obtained from the structural modification software.

14.3 Speed, Frequency and Path of Freight Hysteresis Loops

When including the results from the paper compression test in the model, it became clear that more information is required regarding the shape of the hysteresis loop as a function of speed and reversal point. Some doubt exists as to what happens when the direction in which the force is changing reverses before the force reaches zero. The shape of the curve will also depend on speed. Testing for this was beyond the scope of the equipment used.

14.4 Database and Extraction Software

The applicability of this research depends on the consultant being able to construct a decision support model from a library of wagons, bogies, draw-gears and freight properties. To this end it would be necessary to develop the library of properties and store them in a suitable database. A user interface would also need to be constructed to allow the assembly of the models. This model would then assist in the economic evaluation of the various freight protection and packaging options.

14.5 Multi-body Freight Model

This research used a single freight element model. In reality, freight would be stacked to multiple levels. The model therefore could be extended to freight with multiple degrees of freedom.

REFERENCES

- Anderson C. & Dahlberg T., (1998), 'Wheel/rail impacts at a turnout crossing', *Proceedings of the Institution of Mechanical Engineers* volume 212 no F, London, p123-133
- Anderson D.R., Singh S.P., Miller L.E. & Johnstone B.P., (1996), 'Technical performance and ride quality of a prototype cushioning device for revenue services', *ASME/IEEE Joint Rail Road Conference 1996*, Illinois, p171-175
- Bailey J.R., Wormley D.N. & Hedrick J.K., (1989), 'Suspension model identification from rail vehicle characterization tests', *11 th IAVSD Symposium*, Kingston, August 1989
- Berg M., (1997), 'A model for rubber springs in the dynamic analysis of rail vehicles', *Proceedings of the Institution of Mechanical Engineers* volume 211 no F, London, p95-108
- Bogdanov V.T., (1982), 'Use of dynamic absorber of bending vibrations of a coach body for wagons with double sprung suspension', *Railway Research and Engineering News*, 1982
- Clemson, (2001), 'Finite Element Modeling and Analysis Glossary', <http://www.eng.clemson.edu/~lonny/courses/me818/glossary.html>, 01/12/08
- Cotterel M., (1975), 'Simplified modeling of high order linear systems', *Stress, Vibration and noise Analysis in Vehicles*, Edited by Gibbs H.G. & Richards T.H., Applied Science Publishers Ltd, p351
- Coutellier D., Ravalard Y. & Oudin J., (1991), 'Reanalysis by modal synthesis of railway vehicle structures', *Proceedings of the Institution of Mechanical Engineers* volume 205 no F2, London, p101-108
- Craig R.R jr., (1981), 'Structural dynamics', John Wiley & Sons, New York
- Davis M.A. (chairman), (date unknown), 'Panel discussion on train handling, incorporating freight loss and damage prevention, use of radio, draft gears, roller bearings, integral trains', AAR,
- Dukkipati R.V. & Dong R., (1999), 'Idealized steady state interaction between railway vehicle and track', *Proceedings of the Institution of Mechanical Engineers* volume 213 no F, London, p15-29

- REFERENCES -

- Dutton C.J. , (1990), 'Mathematical modelling of rolling stock impacts', Unpublished masters thesis, Universty of Natal, Durban
- Engineering News, (2001), 'Track system provides continuous support to rails', June 15-21, 2001
- Environ Laboratories Inc (1997) Transportation simulation.
<http://www.environlab.com/transpor.htm>, 04/09/97
- Esveld C., (1989), 'Vehicle response analysis (VRA)', Rail International, June 1989
- Ewins D.J., (1988), 'Modal testing: theory and practice', Research Studies Press, Taunton
- Fröhling R.D., Scheffel H. & Ebersöhn W., (1995), 'The vertical dynamic response of a rail vehicle caused by track stiffness variations along the track', The dynamics of vehicle on roads and on tracks, *Proceedings 14th IAVSD Symposium*
- Fujimoto H., Tanifuji K. & Miyamoto M., (2000) 'Influence of track gauge variation on rail vehicle dynamics (an examination based on comparison between data from a test train running on track with irregularity artificially set and numerical simulation', *Proceedings of the Institution of Mechanical Engineers* volume 214 no F, London, p223-230
- Gorman S.P., (2000), 'Using instrumentation to go beyond pass/fail testing', Sealed Air Corporation,
<http://www.sealedair.com/resources/articles/article7.html>, 10/09/00
- Gracheva L.O., (1982), 'Evaluation of the high frequency components of dynamic forces of goods wagons', Railway Research and Engineering News
- Grassie S.L., (1989), 'Behaviour in track of concrete sleepers with resilient railpads', *Proceedings of the Institution of Mechanical Engineers* volume 203 no. F2, London, p97-101
- Grover R., (1982), 'Train handling relationship to freight loss and damage', *Railway Fuel and Operating Officers Assoc.*, AAR, September 1982
- Hanlon J.F., (1971), 'Handbook of package engineering', McGraw-Hill Book Company USA

- REFERENCES -

- Heyns P.S., (1995), 'Modal testing for structural damage assessment on industrial structures', *Proceedings of Noise and Vibration '95'*, SAIMechE
- Hillel H., Sayer J. & Phipps R.A., (1975), 'Application of the finite element technique to the structural analysis of road and rail vehicles at London Transport', *Stress, Vibration and noise Analysis in Vehicles*, Edited by Gibbs H.G. & Richards T.H., Applied Science Publishers Ltd, p351-388
- In Touch, (2000), 'Flexible polyurethane in packaging', <http://www.pfa.org/intouch/ntouch52.txt>, 10/9/00
- International Union of Railways*, (1962), 'Study of vibration table for testing of packing materials to be used in the transport of goods in railway wagons', *Office for Research and Experimentation of the International Union of Railways*, Utrecht, July 1962
- Irvine T., (2001a), 'Computer shock and vibration concerns', <http://www.idc-online.com/assets/files/computershock.pdf>, 06/12/01
- Irvine T., (2001b), 'Shock response testing for commercial products', <http://www.idc-online.com/assets/files/computershock.pdf>, 06/12/01
- Keresztes A., Bokor J., Várlaki P. & Michelberger P., (1989), 'Identification of partially known vibrating structures', *IAVSD Symposium*, Kingston, August 1989
- Klosterman A & Zimmerman R., (date unknown), 'Modal survey via frequency response functions', Society of Automotive Engineers, inc.
- Krausz A.S. & Eyring H., (1975), 'Deformation kinetics', John Wiley and Sons, New York
- Mester G., (1997), 'Shock duration and fragility', Packtalk, World packaging Organisation, <http://www.packinfo-world.org/wpo/./ShockDurationFragility.html>, 04/09/97
- Michelberger P., Bokor J., Keresztes A. & Várlaki P., (1987), 'Determination of mass, damping and stiffness matrices using structural and parametric identification of linear vehicle frame models', *The dynamics of vehicle on roads and on tracks*, Proceedings 10'th IAVSD Symposium, 1987
- Newcomer G.H., (1959) 'Study of vibration frequencies under impact conditions' ASME, August 1959
- Paine F.A., (1962), 'Fundamentals of Packaging', Blackie and Son Limited

- Parkes A., (2000), 'Applied damage boundary theory and its implication for COTS', <http://saviac.usae.bah.com/sv69abs/u129.htm>, 10/9/00
- Persson I. & Holgersson M., (date unknown), 'Body structure and vehicle dynamics', *The dynamics of vehicle on roads and on tracks*
- Pierce S.R., (1970), 'The effect of impact on packaging from the consumers viewpoint', ASME, 1970
- Progressive Railroading, (1994), 'Damage prevention striking hard at paper, auto claims', (October 1994)
- Scheffel H., (1978) 'The influence of suspension on the hunting stability of railway vehicles', Rail International, 1978
- Scott S.G. & de Bruyn P.J., (1994), 'Comparison of vertical accelerations of paper rolls loaded on SB-3 wagons with and without "papersaver" load protection device fitted', Spoorinet, Rolling stock, Mechanical Engineering project number 352
- SDRC, (1992a), 'Ideas for Test users manual', Structural Dynamics Research Corporation, Ohio
- SDRC, (1992b), 'Ideas Finite Element Analysis users manual', Structural Dynamics Research Corporation, Ohio
- SDRC, (2001), 'Choosing between Guyan, SVI, and Lanczos', Structural Dynamics Corporation, http://www.bullet.me.lehigh.edu/IDEAS/mso_ug/nmd_choos.htm, 01/12/08
- Sherratt F. & Bishop N.W.M., (1990), 'Assessing localised damage from frequency-domain data', Universitätsbibliothek, Hannover
- Simmons L.C., Shackson R.H., (1971), 'Shock and vibration on railroad movement of freight', *Anthology of rail vehicle dynamics*, Volume 1, Freight Car Impact, ASME
- Stichel S., (1999), 'On freight wagon dynamics and track deterioration', *Proceedings of the Institution of Mechanical Engineers* volume 213 no F, London, p243-254
- Tanifuji K., (1991), 'An analysis of the body-bending vibration of a bogie vehicle for an evaluation of the ride quality with deflated air springs', *Proceedings of the Institution of Mechanical Engineers* volume 205 no F1, London, p35-42

- REFERENCES -

Trace Laboratories Central, (1997), 'Vibration and mechanical shock testing', <http://www.methode.com/trace/trace3.htm>, 04/09/97

Vu-Quoc L. & Olsson M., (1989), 'Formulation of a Basic Building Block Model for Interaction of High Speed Vehicles on Flexible Structures', *Journal of Applied Mechanics*.

Appendix A FREQUENCY RESPONSE FUNCTIONS FOR UNLOADED WAGON

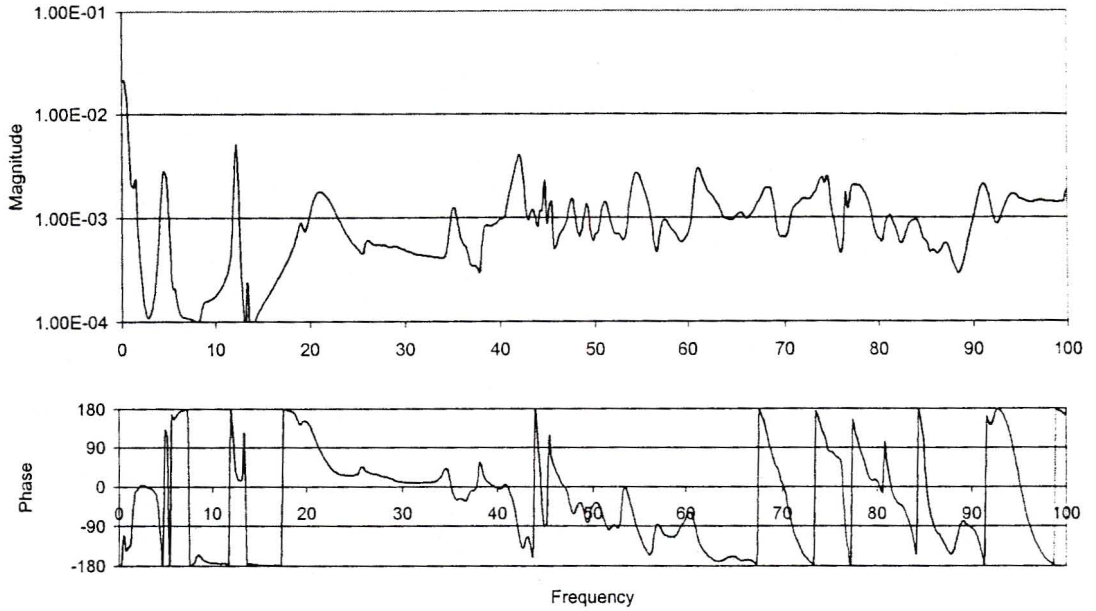

Channel 1

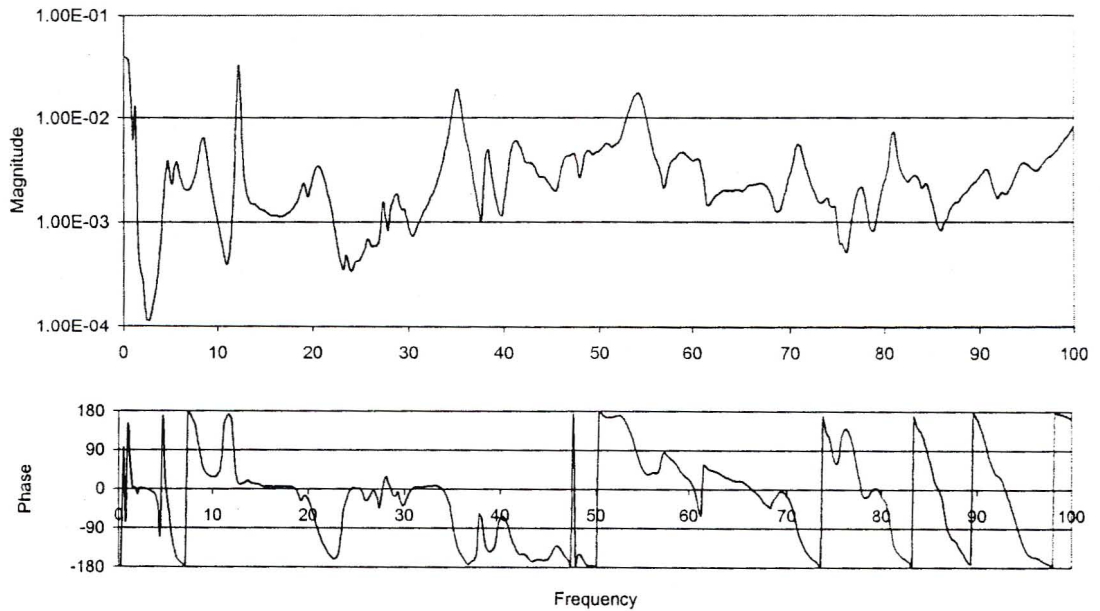

Channel 2

- FREQUENCY RESPONSE FUNCTIONS FOR UNLOADED WAGON -

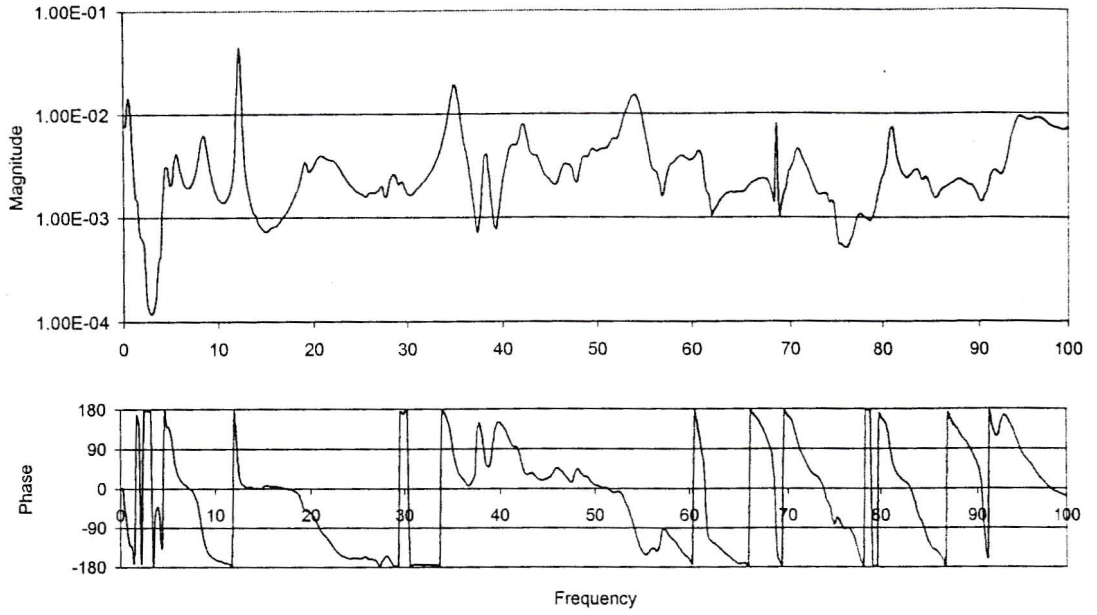

Channel 3

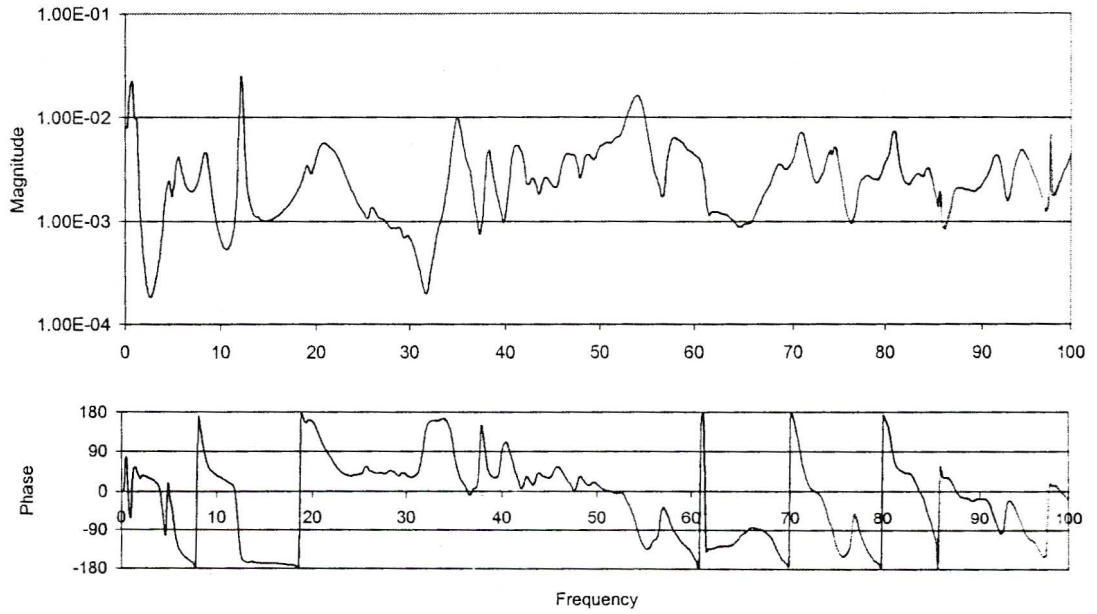

Channel 4

- FREQUENCY RESPONSE FUNCTIONS FOR UNLOADED WAGON -

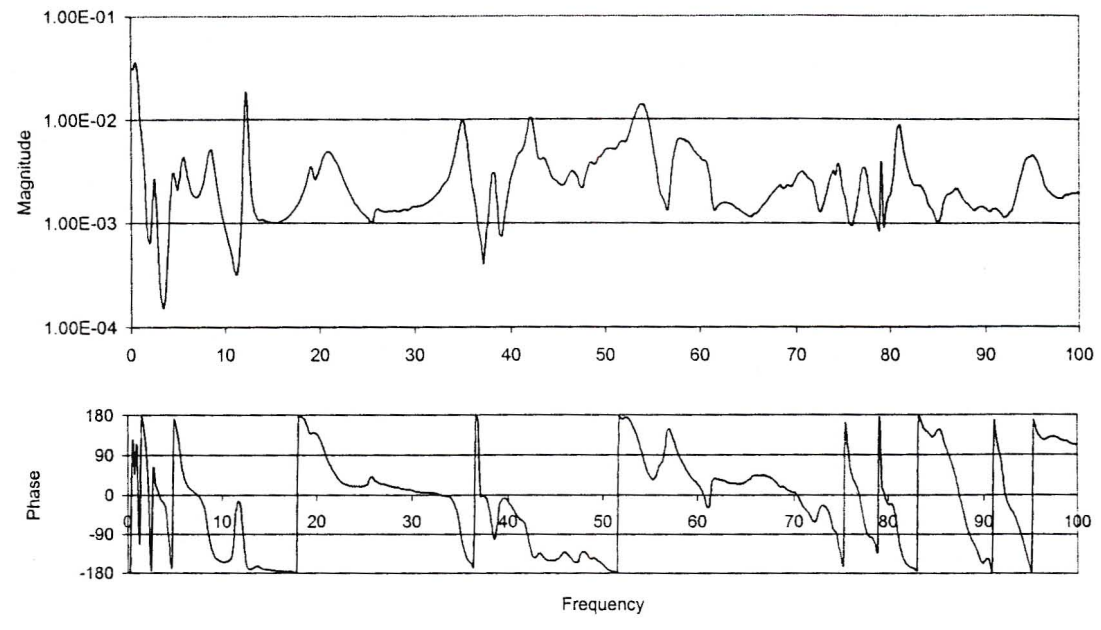

Channel 5

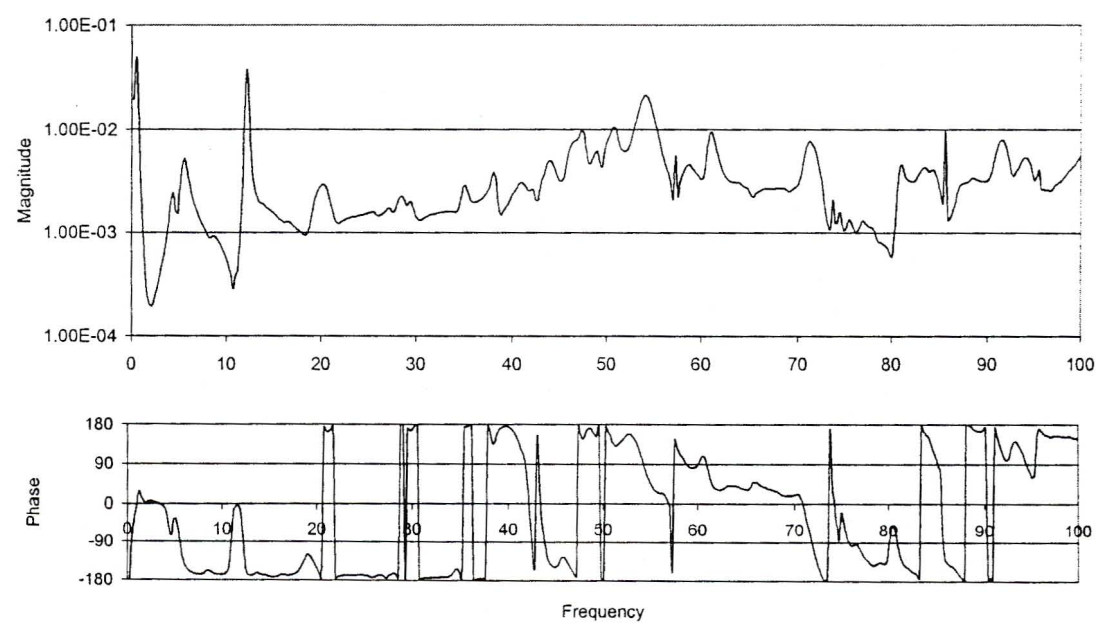

Channel 6

- FREQUENCY RESPONSE FUNCTIONS FOR UNLOADED WAGON -

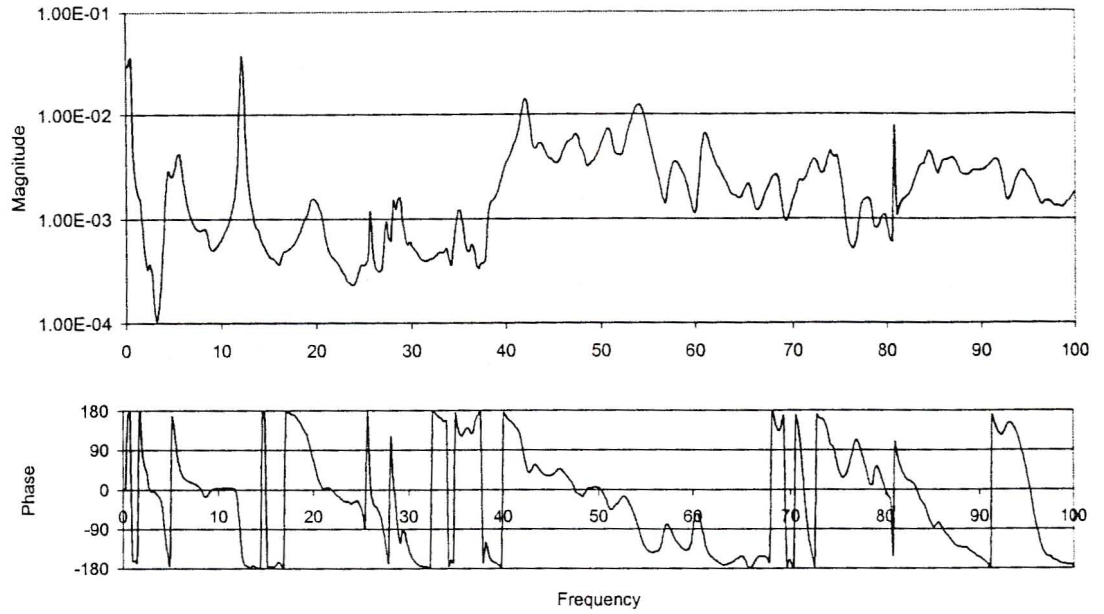

Channel 7

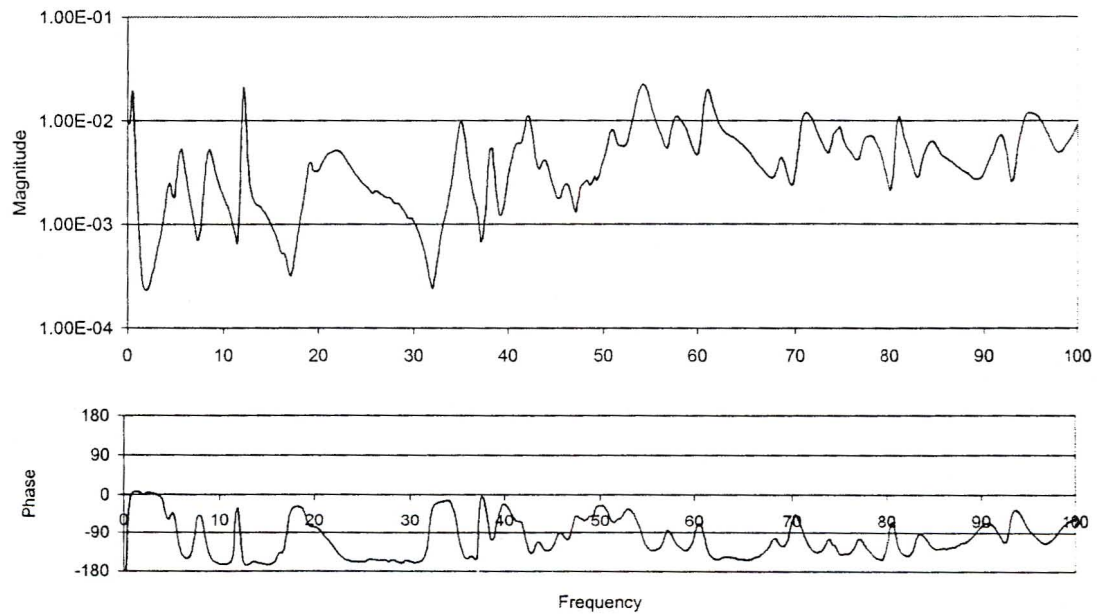

Channel 8

- FREQUENCY RESPONSE FUNCTIONS FOR UNLOADED WAGON -

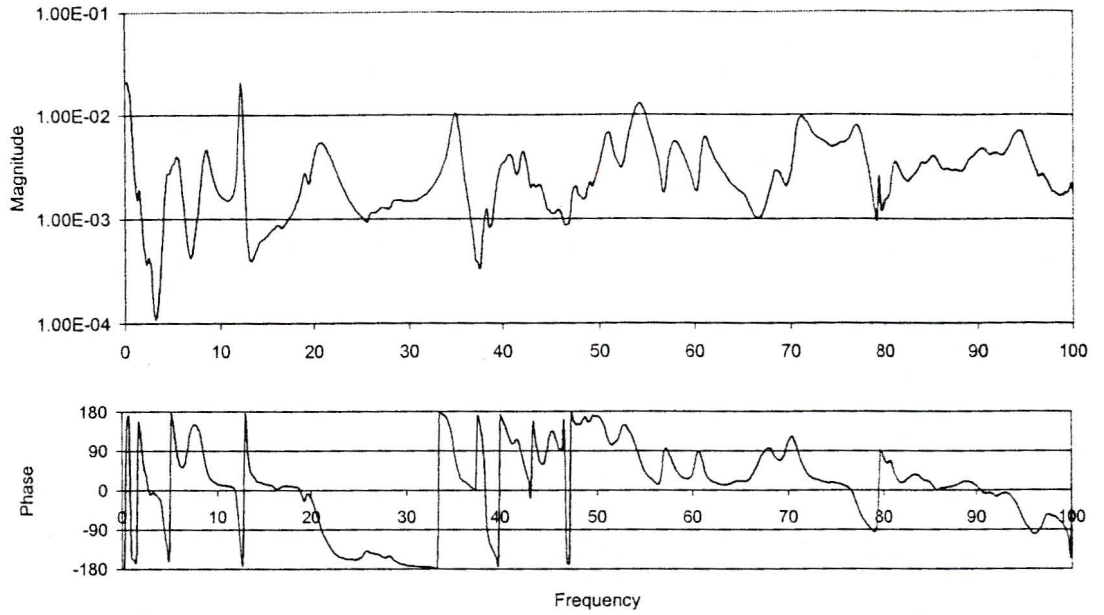

Channel 9

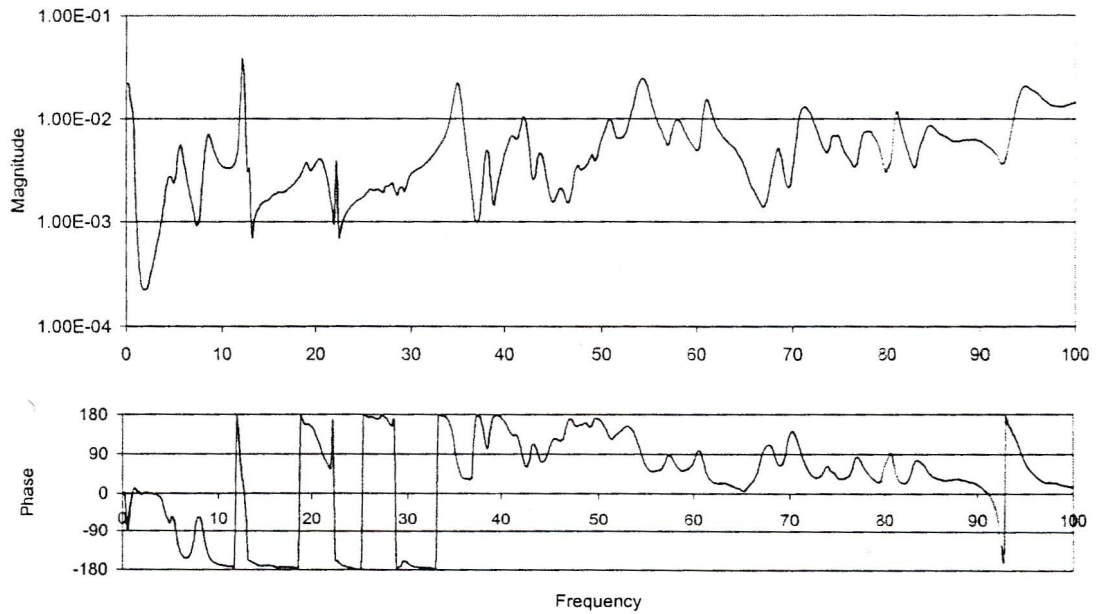

Channel 10

- FREQUENCY RESPONSE FUNCTIONS FOR UNLOADED WAGON -

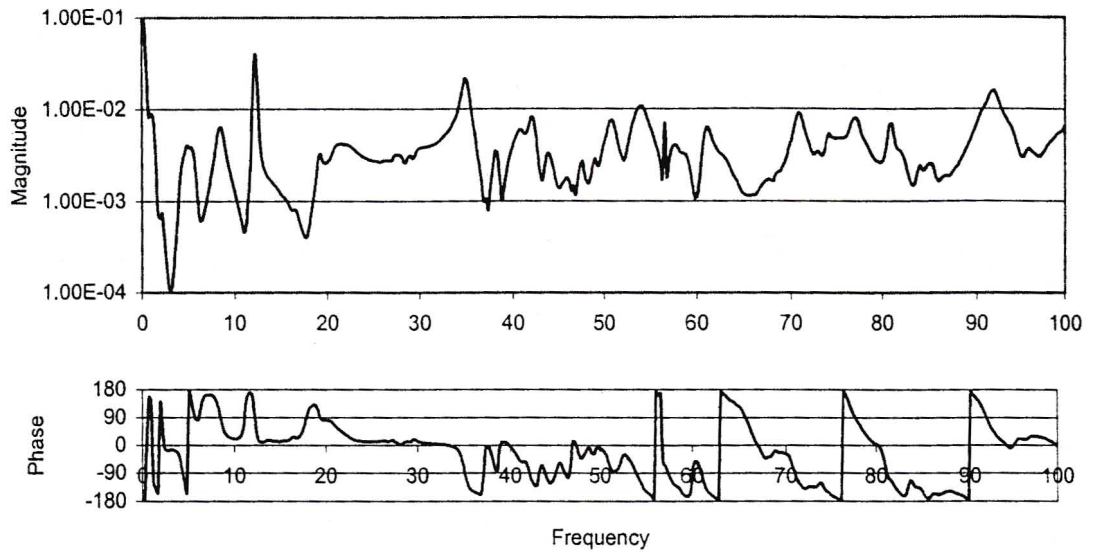

Channel 11

Appendix B EXPERIMENTAL MODAL RESULTS

B.1 Unloaded Wagon

1:4.56 Hz

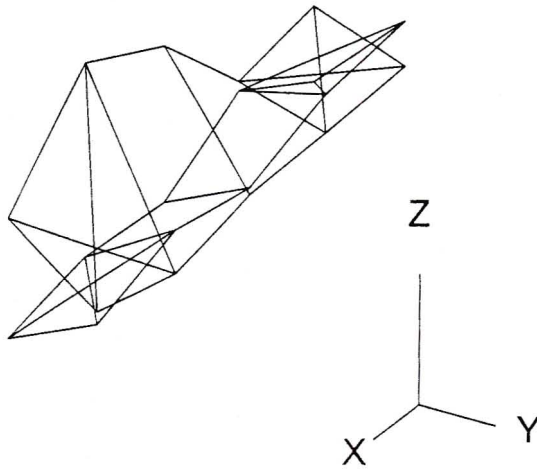

2:12.28 Hz

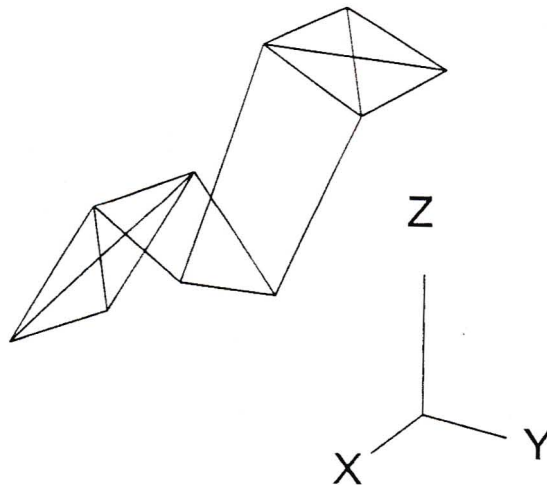

3:21.12 Hz

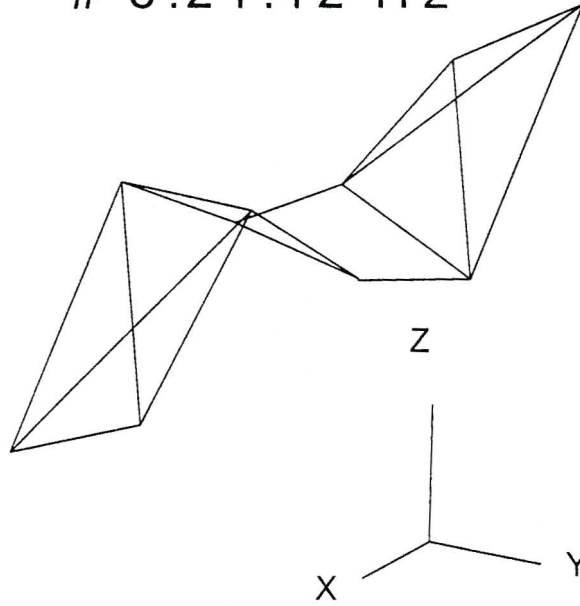

4:26.44 Hz

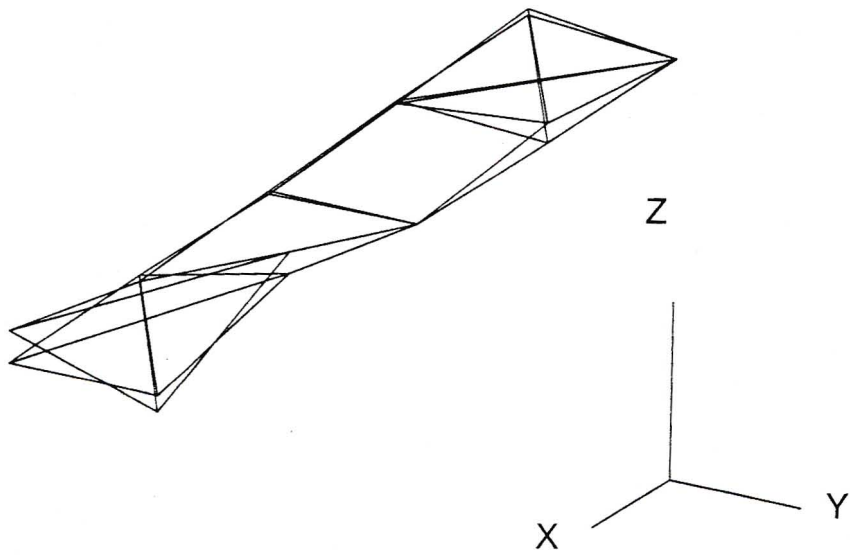

5:35.28 Hz

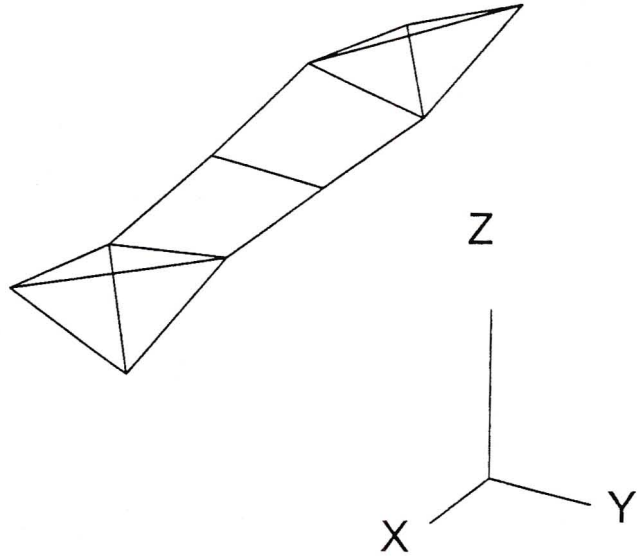

6:38.74 Hz

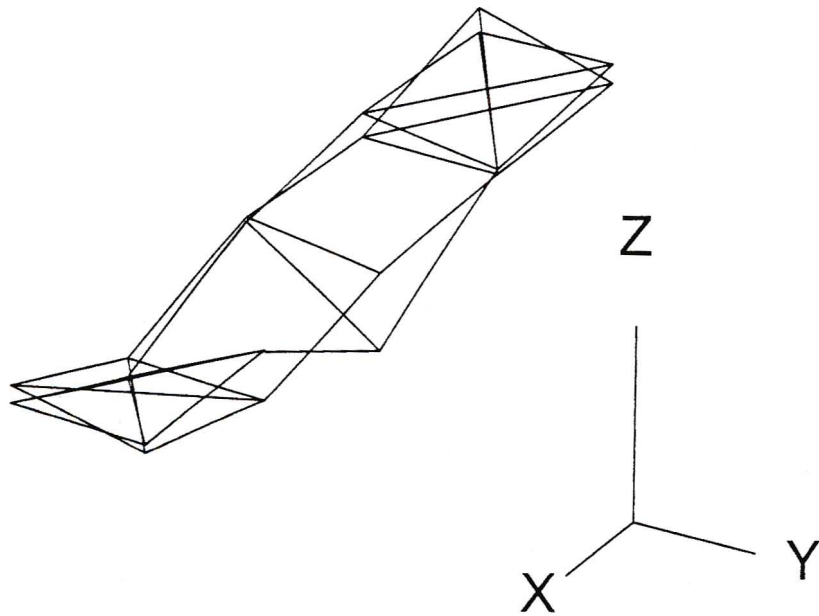

- EXPERIMENTAL MODAL RESULTS -

7:41.90

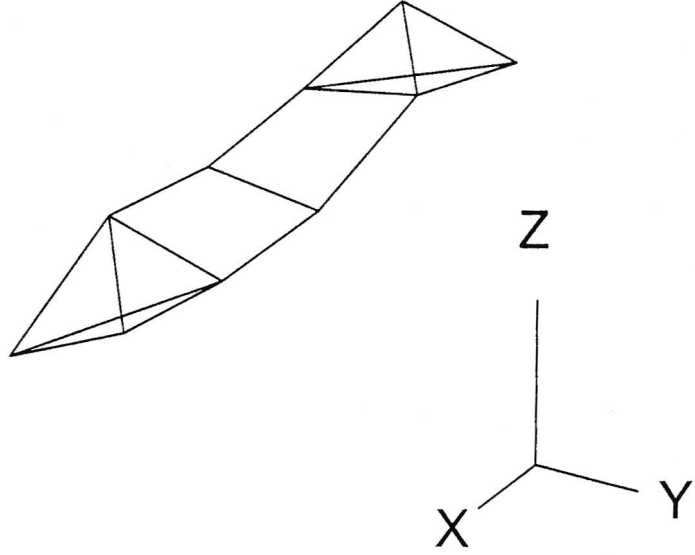

8:43.38 Hz

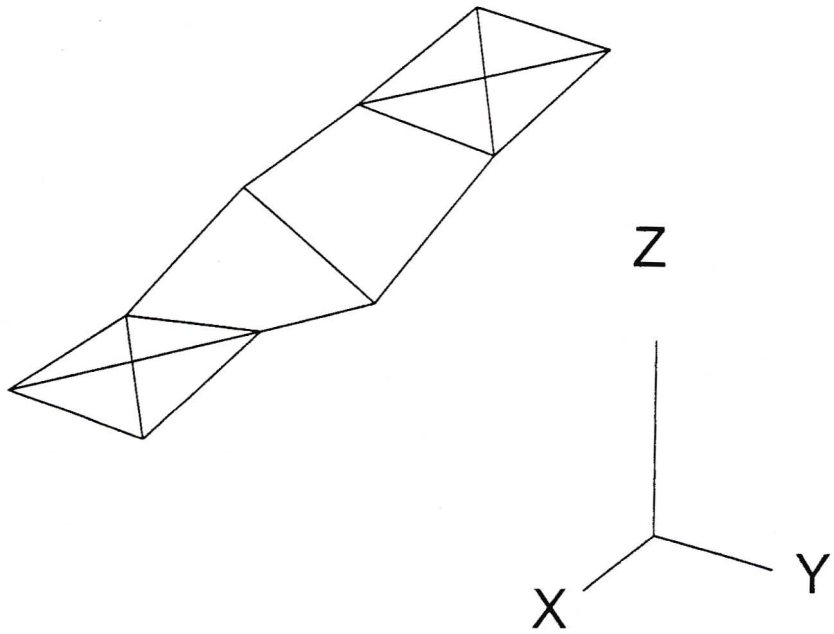

B.2 Mode Shapes Modified with Mass Added

1:4.53 Hz

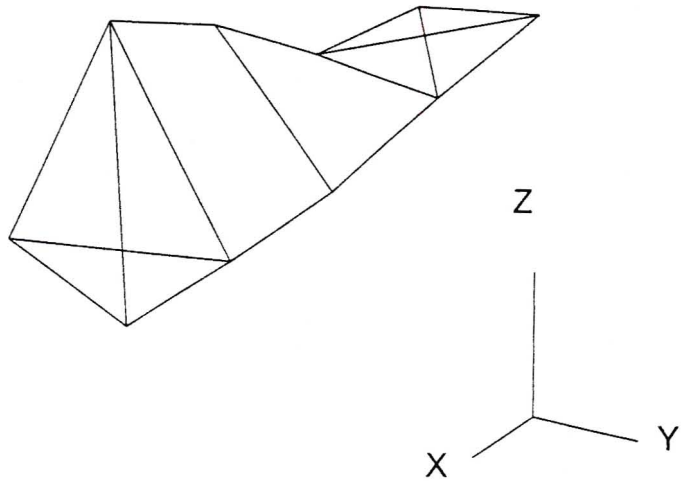

2:11.97 Hz

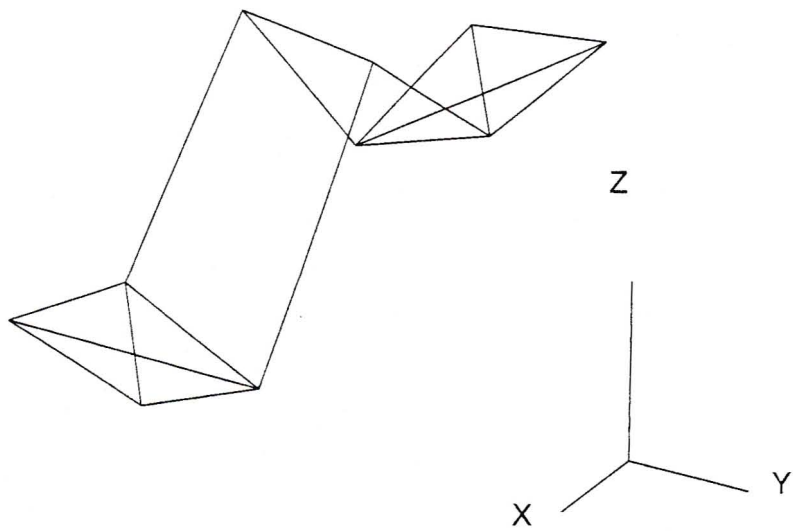

3:17.90 Hz

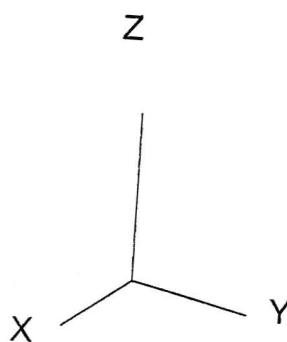
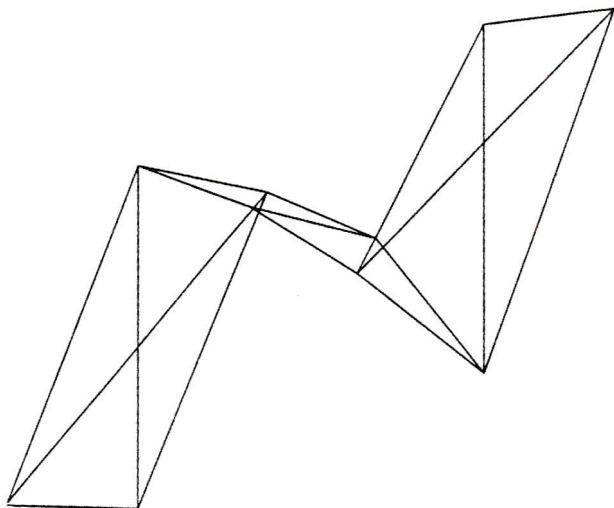

4:26.13 Hz

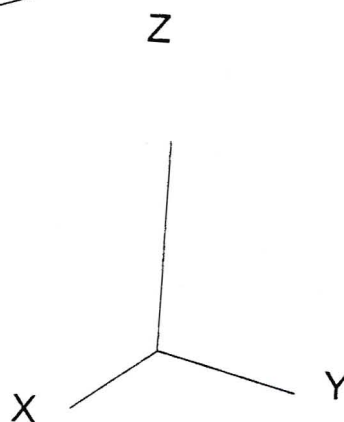
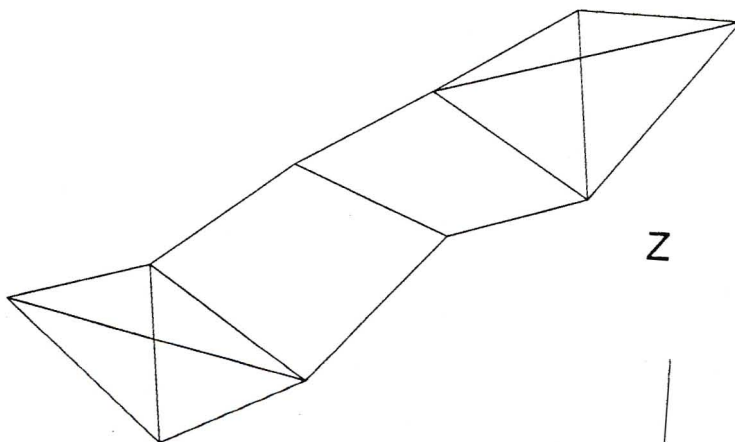

5:33.58 Hz

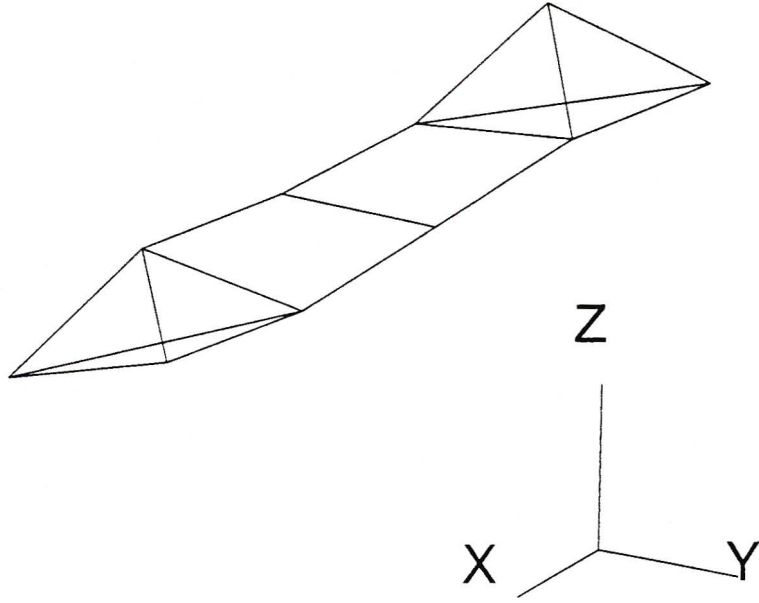

6:38.70 Hz

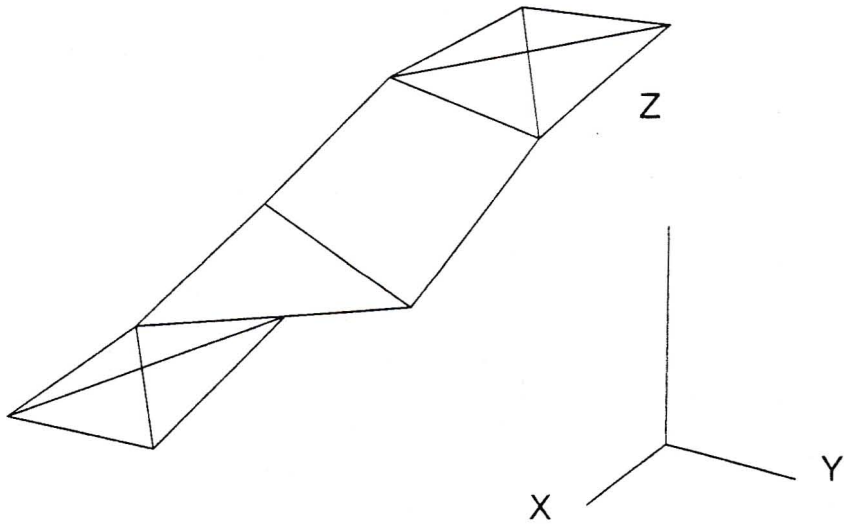

7:40.27 Hz

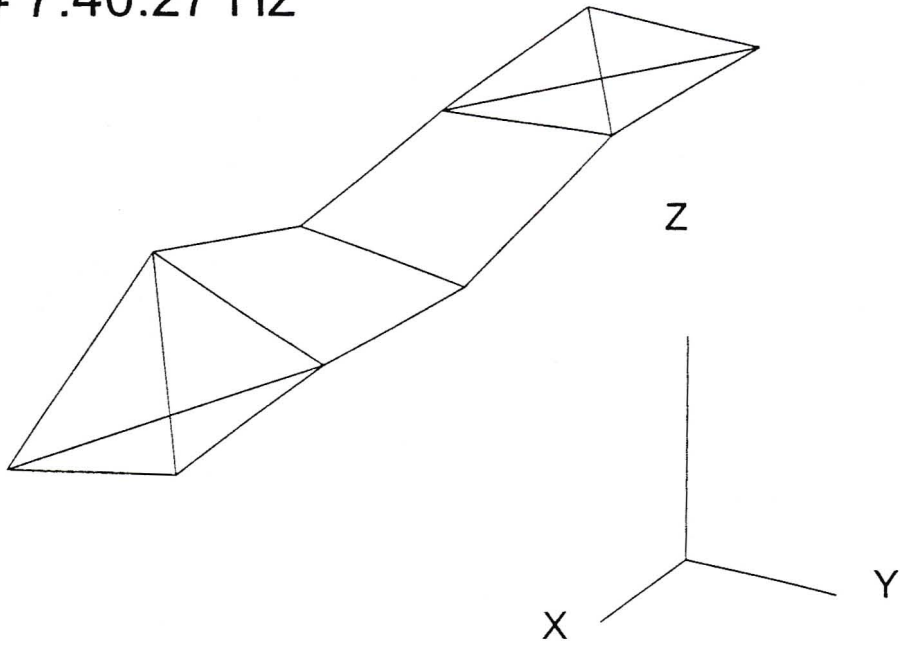

8:43.26 Hz

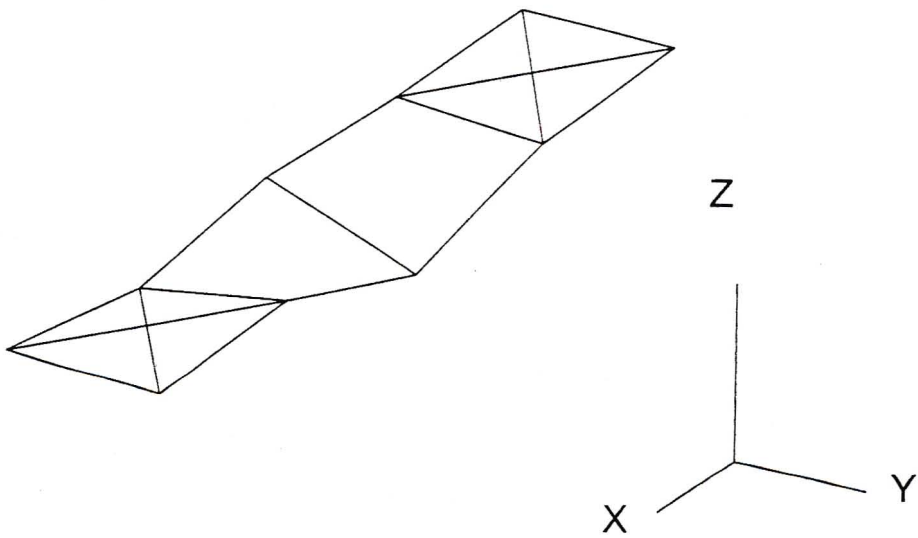

B.3 Mode Shapes Modified with Tuned Damper

#1:4.67 Hz

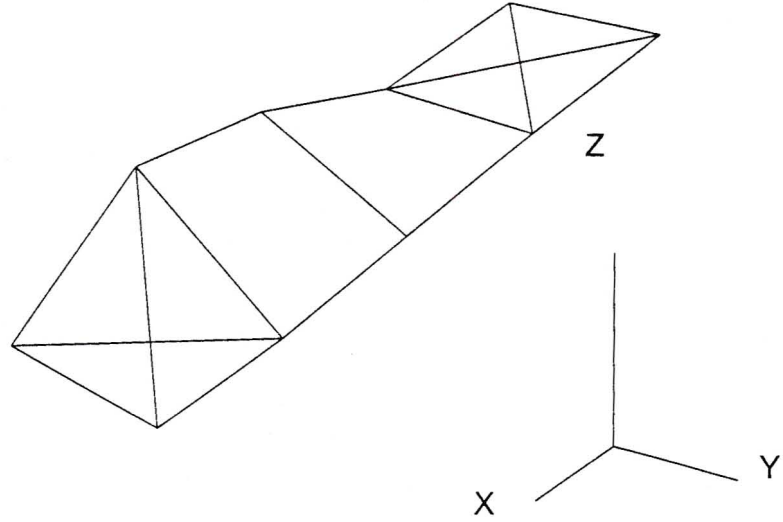

2:12.46 Hz

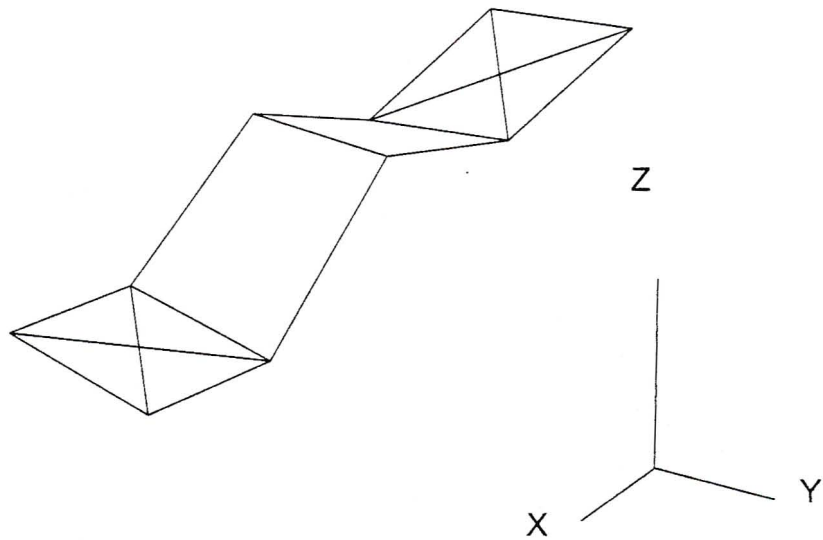

3:21.98 Hz

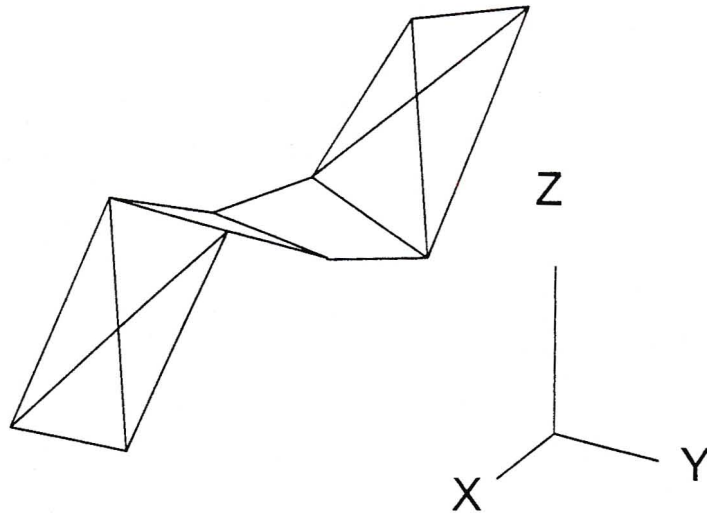

4:26.54 Hz

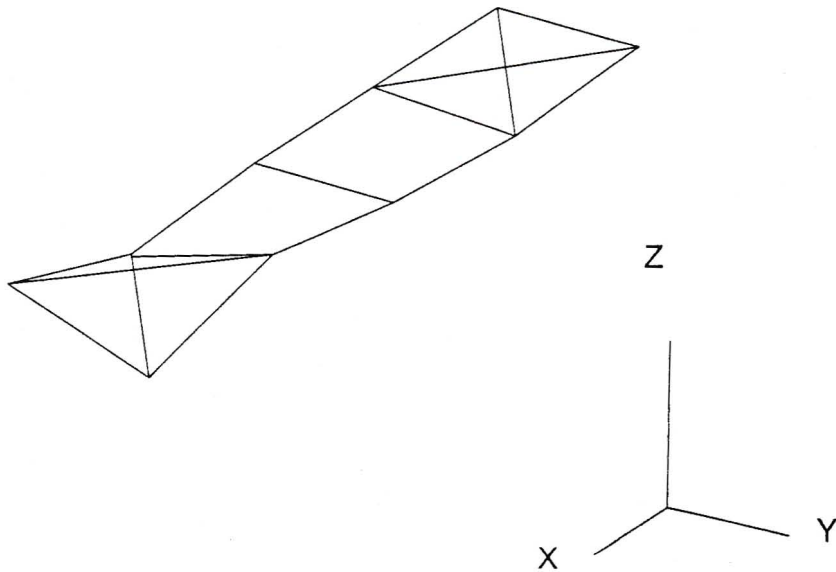

5:35.43 Hz

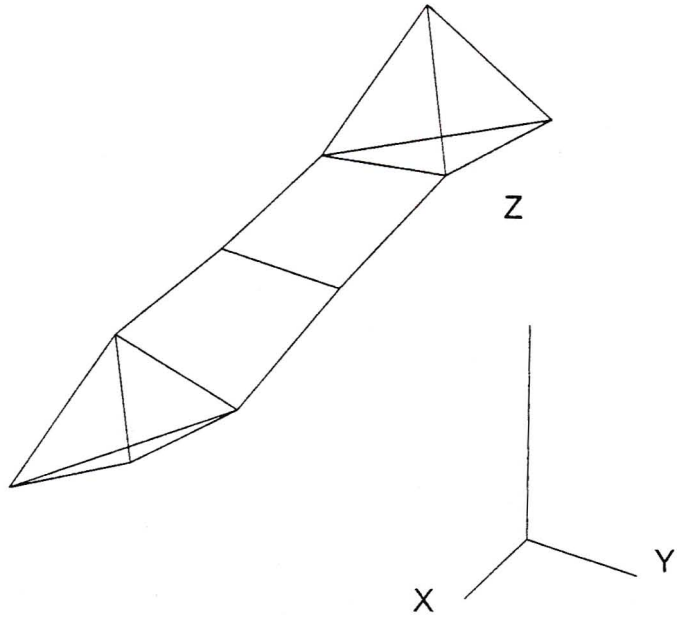

6:38.75 Hz

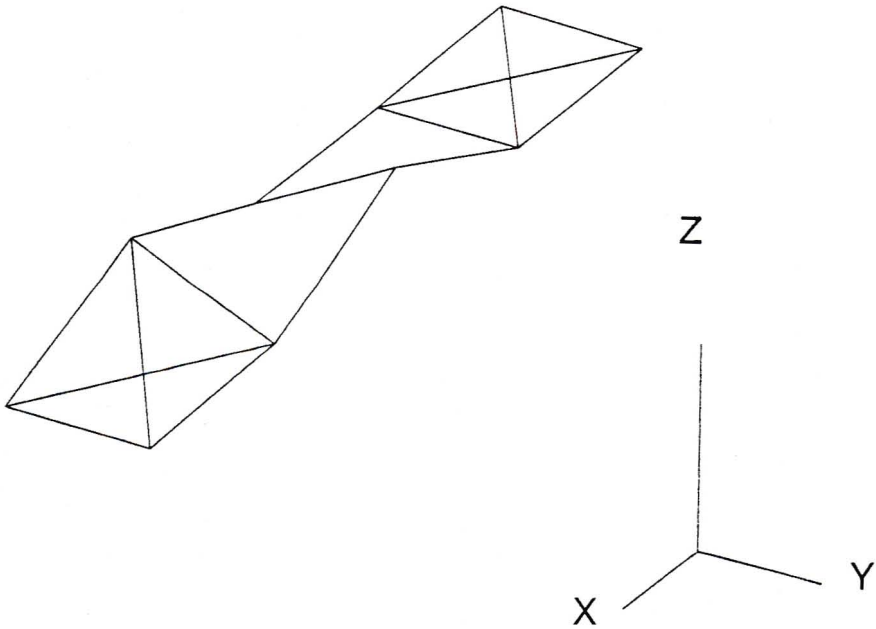

7:42.08 Hz

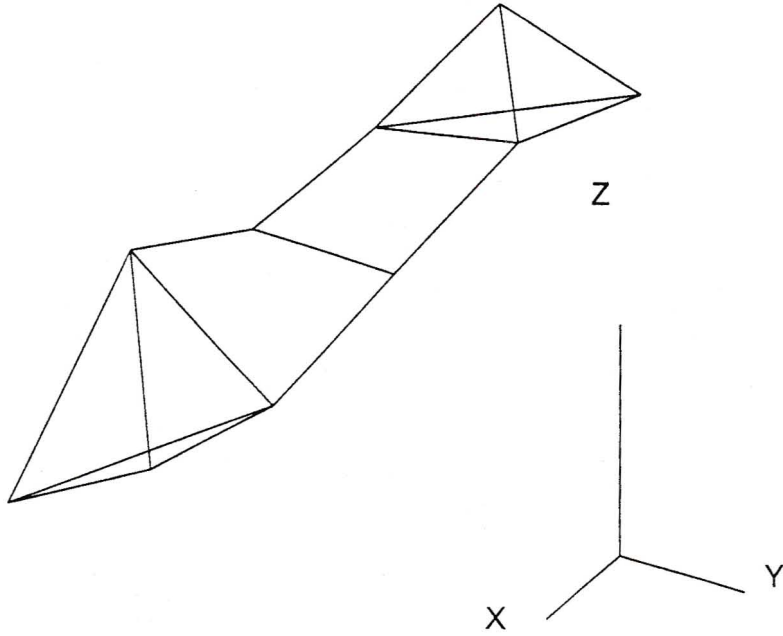

8:43.41 Hz

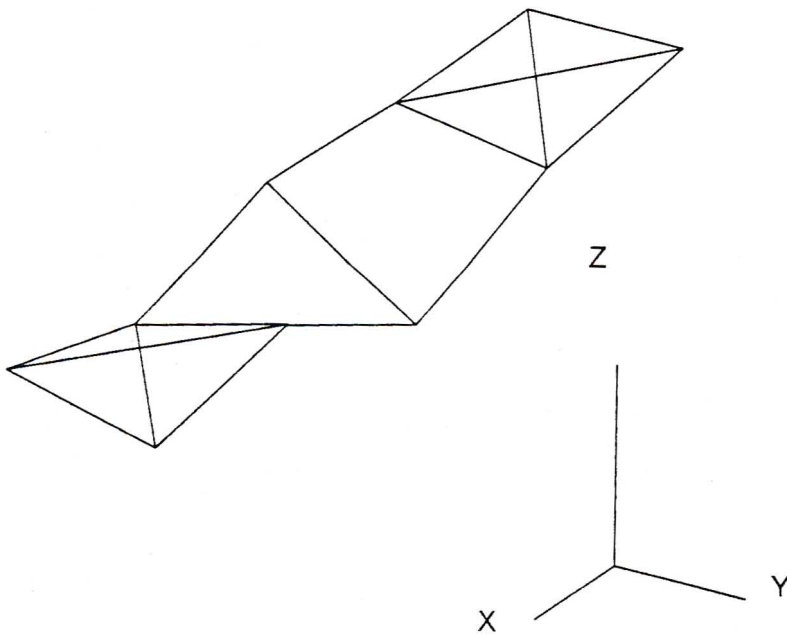

Appendix C FINITE ELEMENT RESULTS

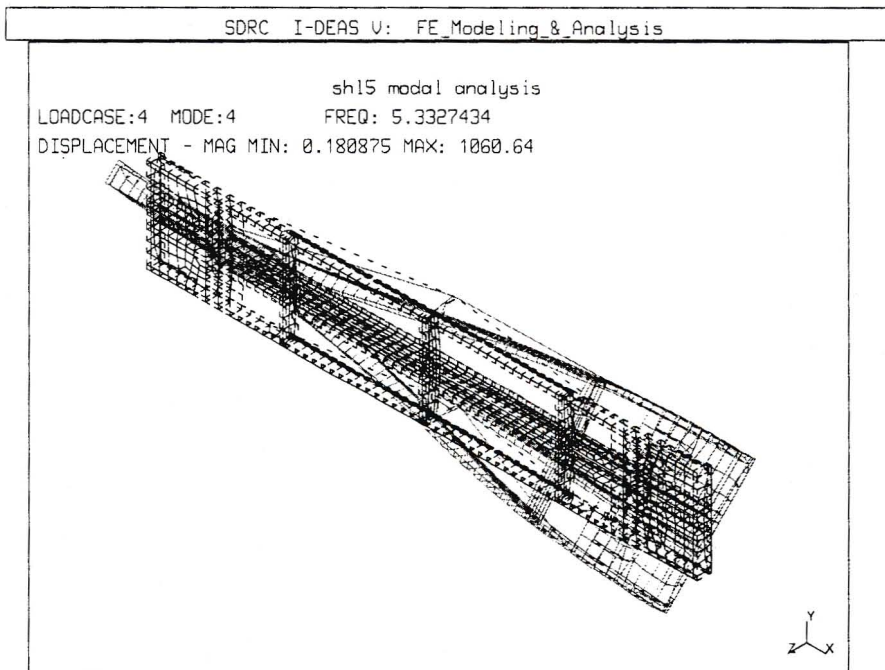
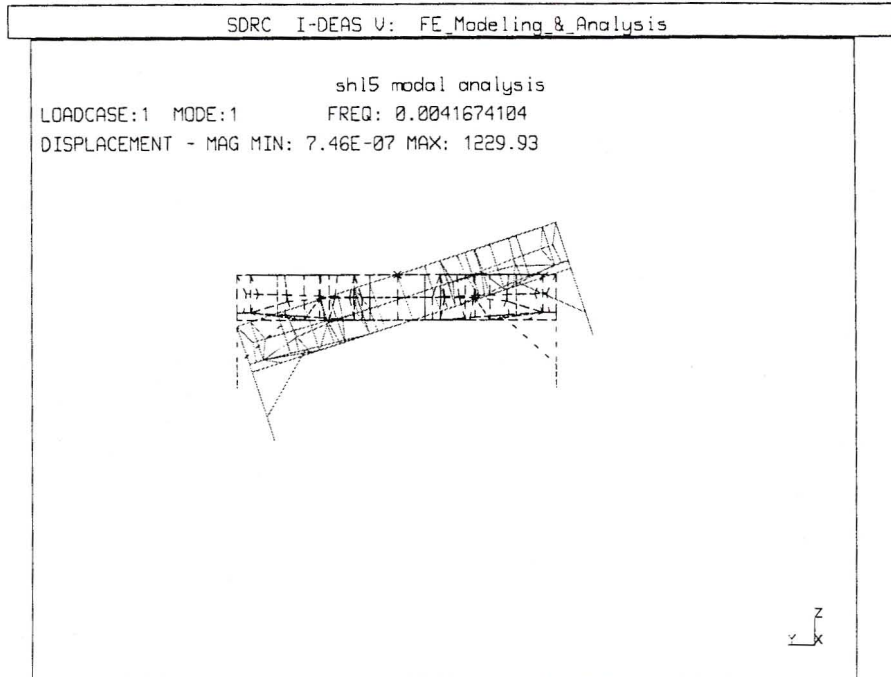

- FINITE ELEMENT RESULTS -

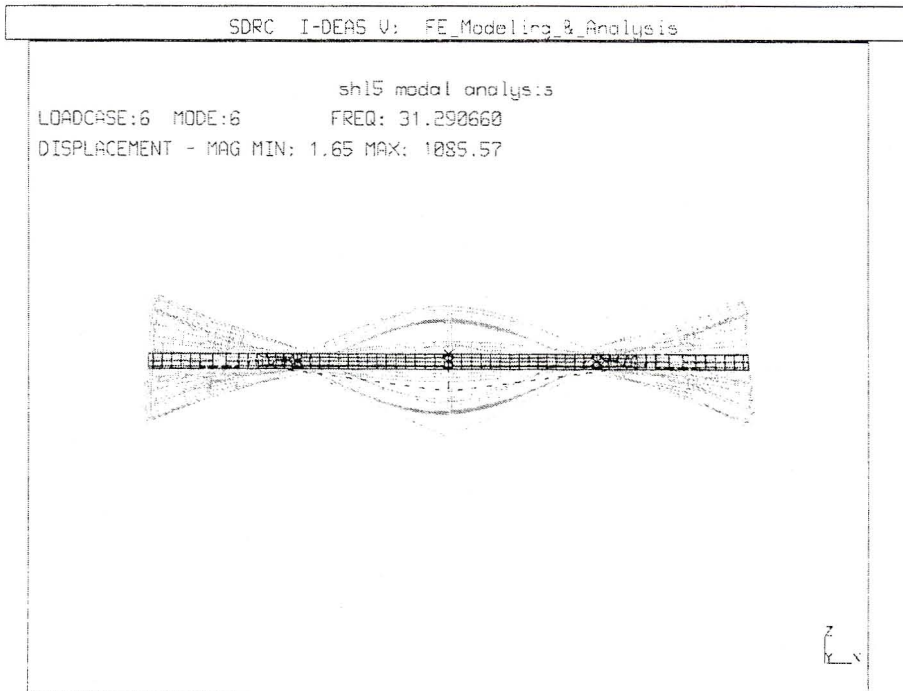
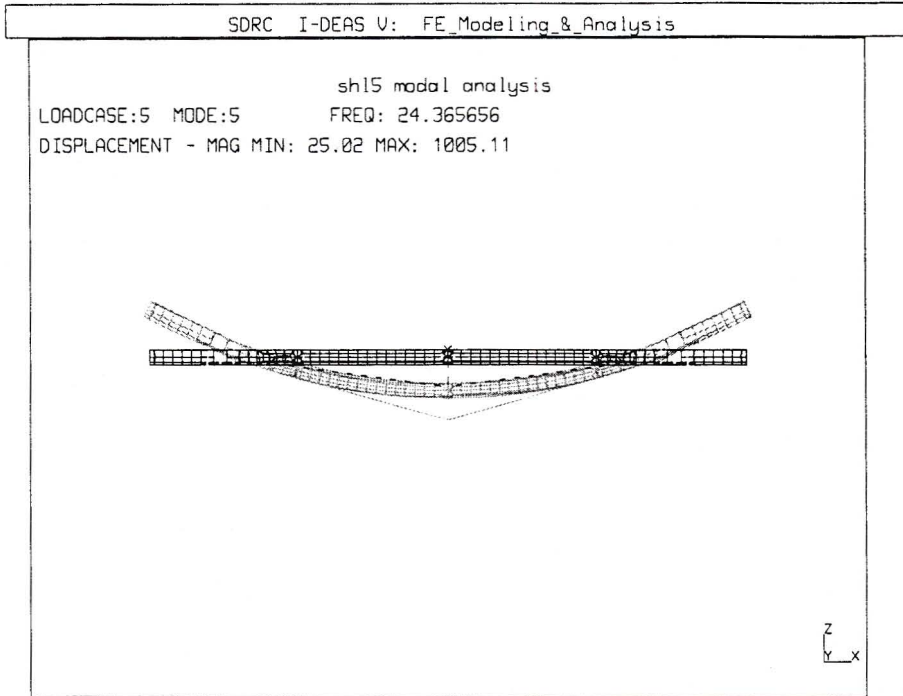

- FINITE ELEMENT RESULTS -

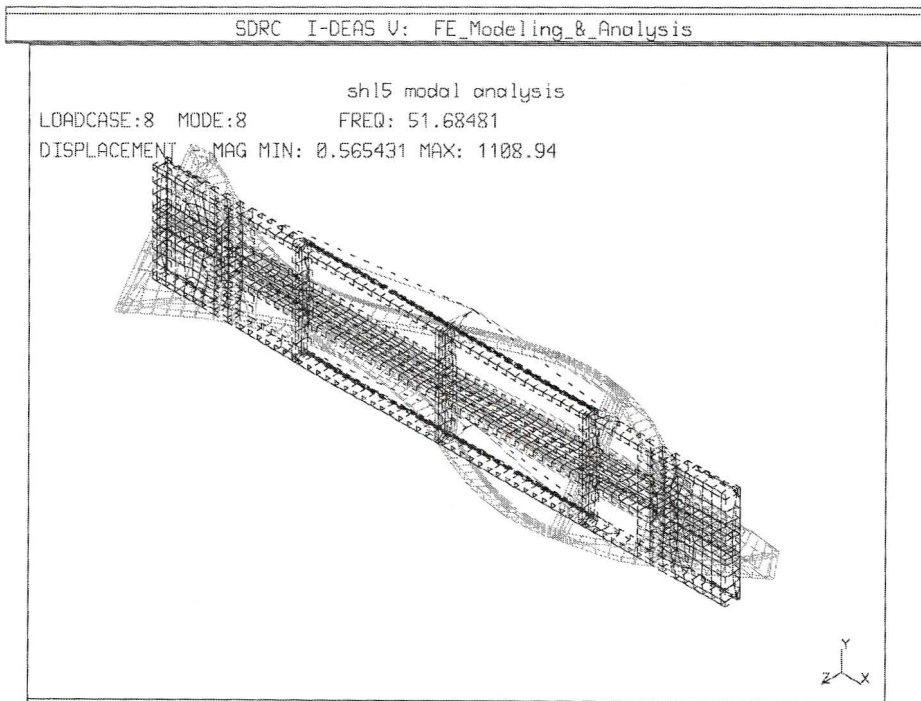
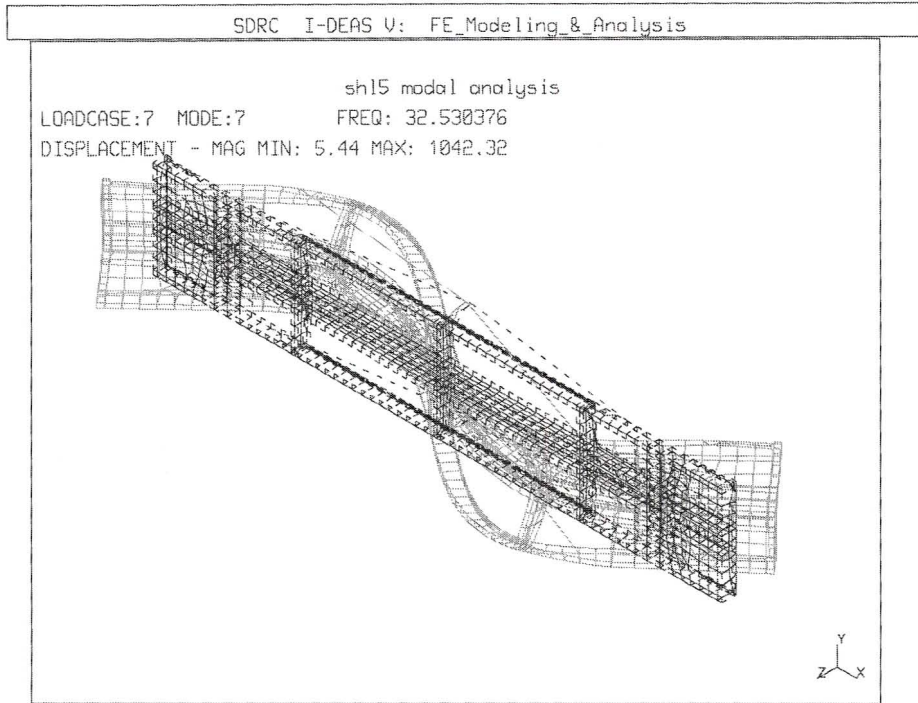

Appendix D PROGRAMS FOR PRODUCING SPECTRA FOR MODAL ANALYSIS

D.1 Program 'BLOCKER'

This program was written in Delphi for removing the file header and dividing data into manageable blocks.

```
unit Main;

interface

uses
  Windows, Messages, SysUtils, Classes, Graphics, Controls, Forms,
  Dialogs,
  StdCtrls, Buttons, FileCtrl, Mask;

type
  TBlockerForm = class(TForm)
    FileListBox: TFileListBox;
    DirectoryListBox: TDirectoryListBox;
    DriveComboBox: TDriveComboBox;
    FilterComboBox: TFilterComboBox;
    FileNameEdit: TEdit;
    Label1: TLabel;
    HeaderIncluded: TCheckBox;
    OKBtn: TBitBtn;
    CancelBtn: TBitBtn;
    BlockSizeEdit: TMaskEdit;
    procedure CancelBtnClick(Sender: TObject);
    procedure OKBtnClick(Sender: TObject);
  private
    { Private declarations }
  public
    { Public declarations }
  end;
```

```
var
  BlockerForm: TBlockerForm;
  Cancel: Boolean;

implementation

uses Convert;

{$R *.DFM}

procedure TBlockerForm.CancelBtnClick(Sender: TObject);
begin
  close;
end;

procedure TBlockerForm.OKBtnClick(Sender: TObject);
var
  inputfile:textfile;
  outputfile:textfile;
  outfilename:string;
  outnameonly:string;
  datastring:string;
  datachar:char;
  filecount:word;
  linecount:longint;
begin
  convertform.show;
  try
    assignfile(inputfile,blockerform.filelistbox.filename);
    reset(inputfile);
    outfilename:=
      changefileext(blockerform.filelistbox.filename,'#.dat');
    outnameonly:=extractfilename(outfilename);
    while length(outnameonly)>12 do delete(outnameonly,7,1);
    outfilename:=extractfilepath(outfilename)+outnameonly;
    if blockerform.headerincluded.checked then
      begin
        datastring:='';
```

- PROGRAMS FOR PRODUCING SPECTRA FOR MODAL ANALYSIS -

```
while not(eof(inputfile)) and (datastring<>'%}') and
  not(cancel) do
begin
  datastring:='';
  datachar:=#0;
  while (datachar<>#10) and not(eof(inputfile)) and
    not(cancel) do
  begin
    read(inputfile,datachar);
    if datachar>#31 then datastring:=datastring + datachar;
  end;
end;
if eof(inputfile) then
begin
  messagedlg('Error Reading Header',mterror,[mbOK],0);
  closefile(inputfile);
  exit;
end;
end;
filecount:=0;
while not(eof(inputfile)) and not(cancel) do
begin
  outfilename[length(outfilename)-4]:=chr(ord('A')-filecount);
  convertform.caption:=outfilename;
  assignfile(outputfile,outfilename);
  rewrite(outputfile);
  linecount:=0;
  while not(eof(inputfile)) and
    (linecount<strtoint(trim(blockerform.blocksizedit.text)))
    and not(cancel) do
  begin
    datastring:='';
    datachar:=#0;
    while (datachar<>#10) and not(eof(inputfile)) and
      not(cancel) do
    begin
      read(inputfile,datachar);
      if datachar>#31 then datastring:=datastring - datachar;
```



```
end;
    writeln(outputfile,datastring);
    inc(linecount);
    convertform.progressbar.position:=trunc(linecount*100/
        strtoint(trim(blockerform.blocksizedit.text)));
    application.processmessages;
end;
inc(filecount);
closefile(outputfile);
end;
except
    closefile(outputfile);
    messagedlg('File Exception Error',mterror,[mbOK],0);
end;
closefile(inputfile);
convertform.close;
end;
end.
```

D.2 Program 'MAKEFRFFILES'

This program was written in MATLAB to accept the raw data files generated by BLOCKER. The unused data channels are stripped. The data is then multiplied by the calibration factors. The program calculates average frequency response functions (FRF) for all the files of data blocks with the same base name. The resulting FRF is then stored in a file with the extension '.tfr'.

```
clear
Namebase=input('File Name :','s')
Nameend='A'; ' scale the data'
teaccal;
' set these values to suit the data acquisition configuration
lines=1024;
fs=250;
window=hanning(lines);
' initialise storage area
avexfer=zeros(lines/2+1,11);
Filename=strcat(Namebase,Nameend,'.dat')
' define path to find data
filepath=strcat('D:\Phd data and progs\',Namebase);
addpath(filepath)
' loop through each file in set
while exist(Filename,'file'),
    rawdata=load(Filename);
    procddata=scale(rawdata(:,4:15),caldata);
    xferdat=zeros(lines/2+1,1);
    for chan=1:11,
        xferdat=tfeprocddata(:,chan),
            procddata(:,12),lines,fs>window,lines/2);
        avexfer(:,chan)=avexfer(:,chan)+xferdat;
    end
    Nameend=Nameend+1;
    Filename=strcat(Namebase,Nameend,'.dat')
```

```
end
filecount=Nameend-'A'
avexfer=avexfer/filecount;
` store each channel
for chan=1:11,
    realdata=real(avexfer(:,chan));
    imagdata=imag(avexfer(:,chan));
    chandata=[realdata';imagdata']';
    if chan<10
        Nameend=strcat('0',num2str(chan));
    else
        Nameend=num2str(chan);
    end
    Filename=strcat(filepath,'\ ',Namebase,Nameend,'.tfr')
    save(Filename,'chandata','-ascii');
end
```

D.3 UFF48Formatter

This program converts the output spectra into universal file format suitable to be read by the Star program.

```
Program unit uff48formatter;

interface

procedure writedata(datafilename:string;datafilenum:integer);

implementation

uses sysutils;

procedure writedata;

const
  endmark='    -1';
  filetype='    58';
  none='NONE';
  datetime='11-Dec-00 08:00:00';
  // change values to suit instrumentation
  excitechannel=8;
  samplefreq=250;
  lines=256;
  E13_5=' 0.00000E+00; -0.00000E+00';
  abscissa='          18    0    0    0 NONE          NONE  ';
  ordinate='          12    0    0    0 NONE          NONE  ';
  denomtim='           0    0    0    0 NONE          NONE  ';
  denomfrq='          13    0    0    0 NONE          NONE  ';
  zaxis   ='           0    0    0    0 NONE          NONE  ';

type
  fileline=string[80];
var
  linecount:integer;
  description:fileline;
  xducerid:fileline;
```

```
timeresp:fileline;
freqresp:fileline;
dataformtim:fileline;
dataformfrq:fileline;
numstr:string[10];
dataline:fileline;
realpart,imagpart:real;
inputfile:text;
outputfile:text;
colpoint:integer;
begin
// Open files
  assignfile(inputfile,datafilename+'.tfr');
  reset(inputfile);
  linecount:=0;
  while not(eof(inputfile)) do
  begin
    readln(inputfile,dataline);
    inc(linecount);
  end;
  closefile(inputfile);
  assignfile(inputfile,datafilename+'.tfr');
  reset(inputfile);
  assignfile(outputfile,datafilename+'.asc');
  rewrite(outputfile);
// Header
  writeln(outputfile,endmark);
  writeln(outputfile,filetype);
  writeln(outputfile,datetime);
//1
  writeln(outputfile,none);
//2
  writeln(outputfile,datetime);
//3
  xducerid:='EXCITATIONRESPONSE';
  writeln(outputfile,xducerid);
//4
  writeln(outputfile,none);
```

- PROGRAMS FOR PRODUCING SPECTRA FOR MODAL ANALYSIS -

```
numstr:=inttostr(datafilenum);
while length(numstr)<10 do numstr:=' '+numstr;
//5
timeresp:=' 1 0 0 0 NONE '+numstr+
' 3 NONE 12 -3';
freqresp:=' 4 0 0 0 NONE '+numstr+
' 3 NONE 8 -3';
writeln(outputfile,freqresp);
//6
numstr:=inttostr(linecount);
while length(numstr)<10 do numstr:=' '+numstr;
dataformtim:=' 2'+numstr+
' 1 0.00000E+00'+
formatfloat(E13_5,(samplefreq/2/lines))+' 0.00000E+00';
dataformfrq:=' 5'+numstr+' 1 0.00000E+00'+
formatfloat(E13_5,(samplefreq/2/lines))+' 0.00000E+00';
writeln(outputfile,dataformfrq);
//7
writeln(outputfile,abscissa);
//8
writeln(outputfile,ordinate);
//9
writeln(outputfile,denomfrq);
//10
writeln(outputfile,zaxis);
//11
//Data
while not(eof(inputfile)) do
begin
for colpoint:=1 to 3 do
begin
if not(eof(inputfile)) then
readln(inputfile,realpart,imagpart)
else
begin
realpart:=0.0;
imagpart:=0.0;
end;
end;
```

- PROGRAMS FOR PRODUCING SPECTRA FOR MODAL ANALYSIS -

```
    write(outputfile,formatfloat(E13_5,realpart),  
          formatfloat(E13_5,imagpart))  
    end;  
    writeln(outputfile);  
end;  
writeln(outputfile,endmark);  
closefile(inputfile);  
closefile(outputfile);  
end;  
end.
```

Appendix E MATLAB CODE FOR ANALYSING DRAW-GEARS

This program takes the unscaled data stored in the file with the filename stored in the variable file. It removes the noise created by the starting and stopping of the tape drive by setting a trigger of 0.8 Volts on channel 2 which appeared to be clear of the noise. Seven readings before the event until twenty-four readings after the event were taken giving a frame size of thirty two readings for the the FFT routine.

The cleaned results are stored in the variable : outdata,

The PSD is stored in the variable : power.

```
inarray=load(file);
maxarray=(inarray(:,2)>0.8);
diffarray=diff(maxarray);
trigarray=find(diffarray>0);
eventcnt=size(trigarray,1);
eventspace=800;
prevevent=-eventspace;
events=0
for eventpnt = 1:eventcnt,
    if (trigarray(eventpnt)-eventspace)>prevevent
        outbegin=events*32+1;
        outend=events*32+32;
        inbegin=trigarray(eventpnt)-7;
        inend=trigarray(eventpnt)+24;
        outarray(outbegin:outend,:)=inarray(inbegin:inend,:);
        prevevent=trigarray(eventpnt);
        events=events+1;
    end
end
cal=[825000,25,5,5]
outdata=scale(outarray,cal)
[power,f]=psd(outdata(:,1),32,125,32,0)
```

- MATLAB CODE FOR ANALYSING DRAW-GEARS -

```
xfer=tfe(outdata(:,4),outdata(:,1),32,125,32,0)
figure(1)
semilogy(f,power)
figure(2)
semilogy(f,abs(xfer))
figure(3)
plot(outdata)
```

Appendix F CURVES PREPARED FOR PAPER ROLL PROPERTIES

These curves were prepared by $\epsilon\delta C$ staff to characterise the dynamics of paper rolls.

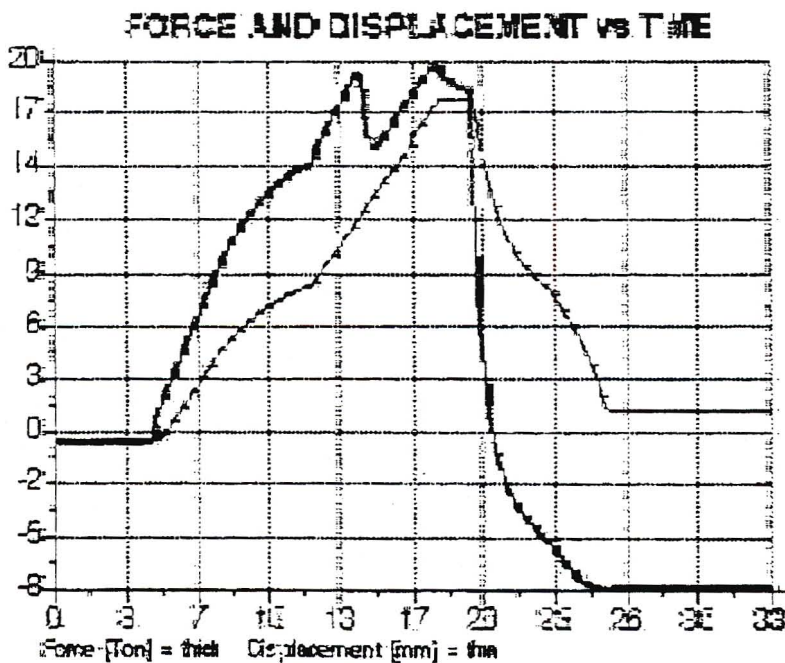
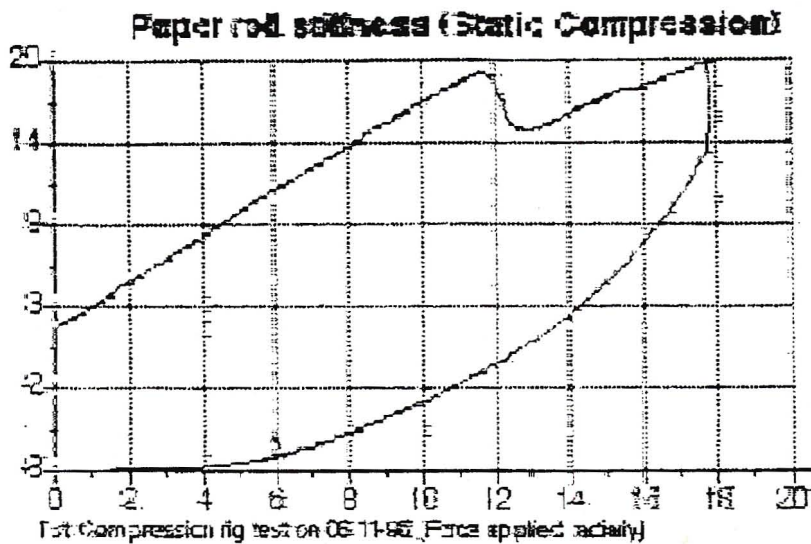

Paper roll stiffness (Static Compression)

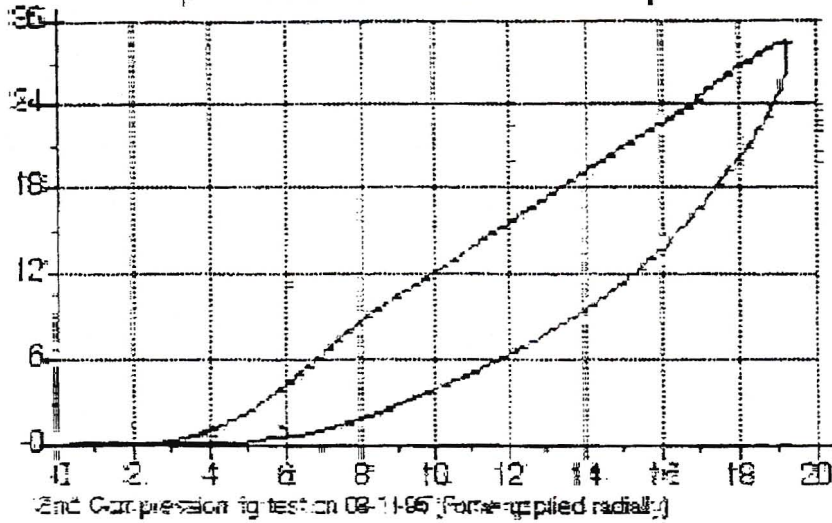

FORCE AND DISPLACEMENT vs TIME

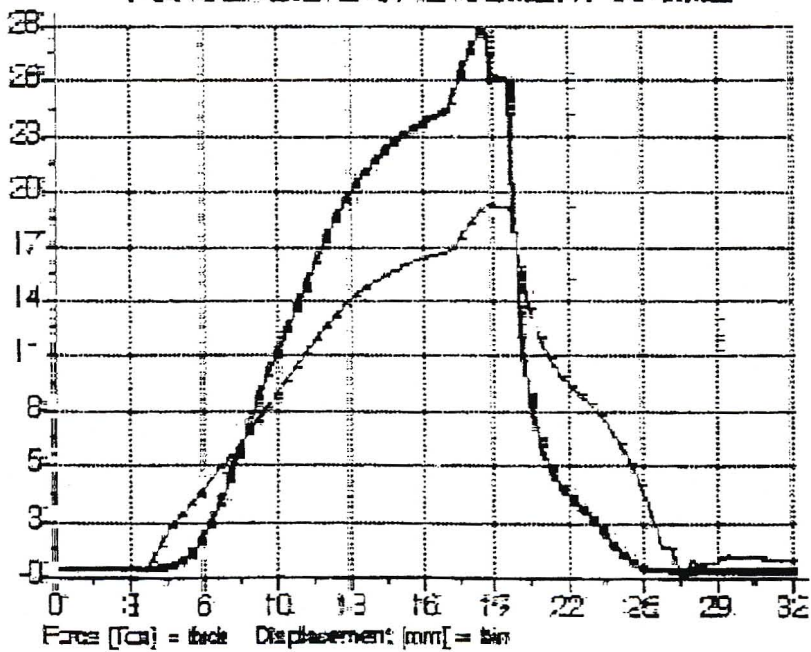

Paper roll stiffness (Static Compression)

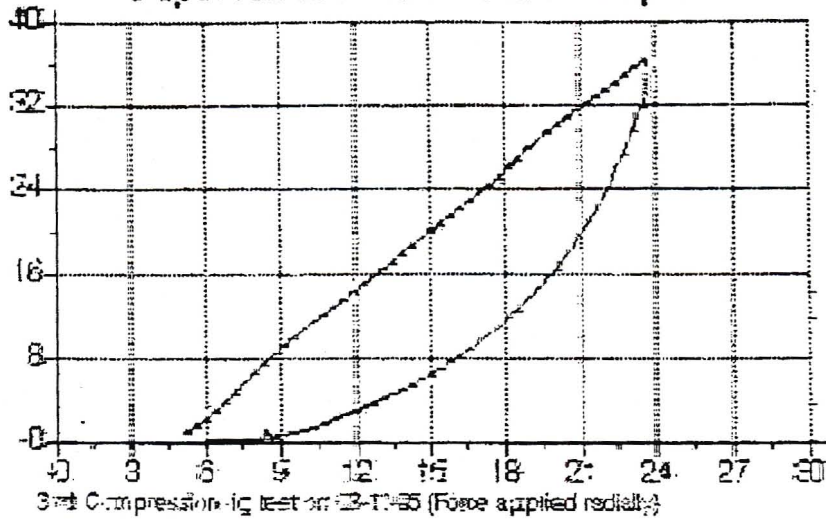

FORCE AND DISPLACEMENT vs TIME

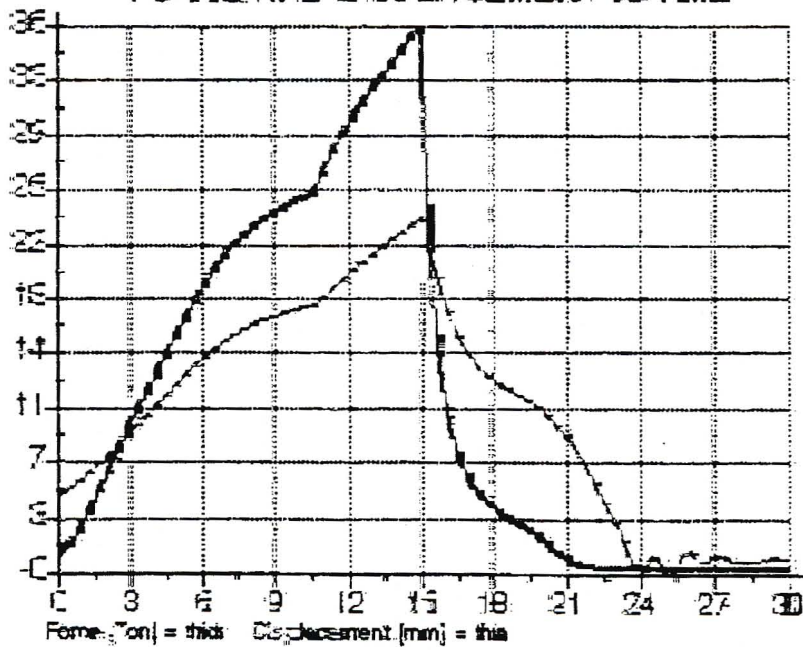

Paper roll stiffness (Static Compression)

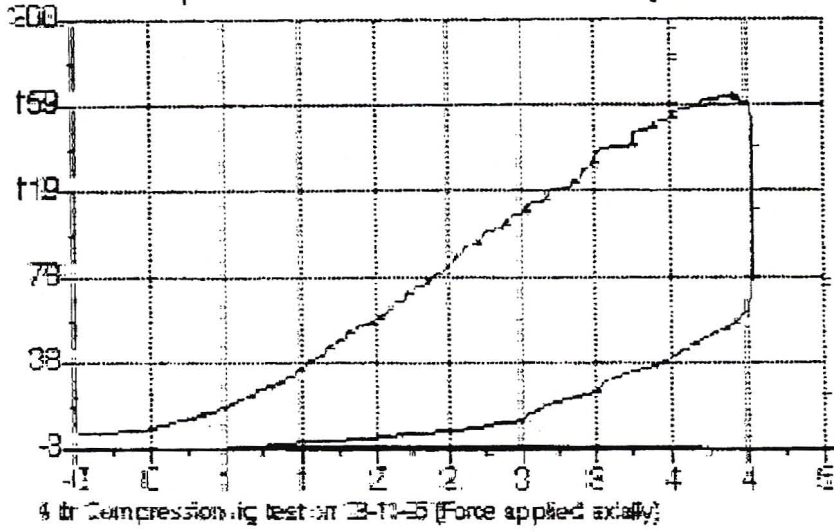

FORCE AND DISPLACEMENT VS TIME

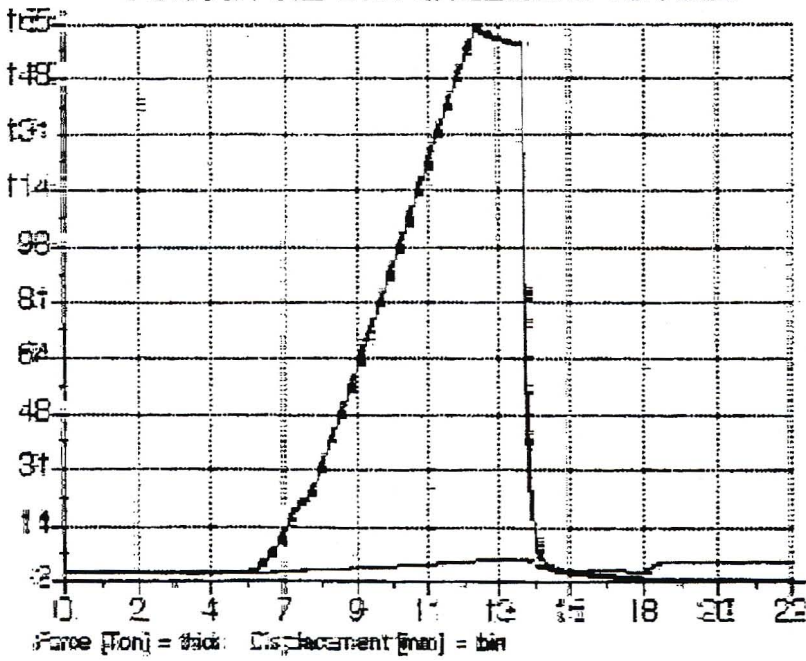

Appendix G PROGRAM FOR ANALYSIS OF HORIZONTAL PAPER ROLL

This program was developed in Advanced Continuous Simulation Language (ACSL) for investigating the conditions under which slip would occur when a cylinder is loaded transverse to a rail wagon.

G.1 CSL Program File

```
PROGRAM wobble
```

```
INITIAL
```

```
  RESET("NOEVAL")
  PARAMETER(pi=3.141592 , g=9.805)
  CONSTANT Rw=4.0 , a=0.00005 , freq=10.0 , &
  me=1000.0, k=4000000.0, alpha=3.5, d=0.8 , &
  mus=0.25 , mud =0.2
  om= 2.0*pi*freq
  aom = a*om
  phidic=aom
  logical slipping
  xric= -me*g/k
  fhold=me*g
  fmax=fhold
  dxhold=-xric
  dxmax=dxhold
  slipping=.false.
  j=d*d/8*me
END ! of initial
```

```
DYNAMIC
```

```
ALGORITHM IALG = 4
NSTEPS NSTP = 1
MAXTERVAL MAXT = 0.050
MININTERVAL MINT = 1.0E-6
CINTERVAL CINT = 0.001
```

- LIST OF EQUIPMENT -

DERIVATIVE

! wagon mode rotation

thdd=-aom*om*sin(om*t)

thd=integ(thdd,aom)

th=integ(thd,0)

! wagon vertical motion

xw=Rw*th

xwd=Rw*thd

xwdd=Rw*thdd

! vertical motion of roll

xrdd=fv/me-g

xrd=integ(xrdd,xrdic) ; constant xrdic=0.0

xr=integ(xrd,xric)

! relative motion of roll and wagon

dxd=xwd-xrd ! >0 => moving together

dx=xw-xr ! >0 => wagon pushing on roll <0

! separation

! vertical force on roll

SCHEDULE maxdx .XN. dxd

dxmax=rsw(dxd .ge. 0.0 , dx,dxhold)

fmax=rsw(dxd .ge. 0.0 , k*dx,fhold)

fcomp=k*dx

fexp=fmax*(exp(alpha*dx/dxmax)-exp(-alpha*dx/dxmax))/ &
(exp(alpha)-exp(-alpha))

fv=RSW(dxd.gt. 0.0,fcomp,fexp)

! friction limit

- LIST OF EQUIPMENT -

```
tstatic=mus*fv*d/2
tslip=mud*fv*d/2

! rotation of roll

phidd=rsw(slipping,sign(tslip/j,thd-phid),thdd)
phid=integ(phidd,phidic)
phi=integ(phid,0.0)

! torque on roll

tau=j*phidd
schedule startslip .XN. tstatic-tau
schedule stopslip .XZ. thd-phid

END ! of derivative

CONSTANT TSTOP = 10
TERMT( T .GE. TSTOP )

DISCRETE maxdx
  dxhold=dx
  fhold=fcomp
END ! of discrete

DISCRETE startslip
  slipping=.true.

END ! of startslip

DISCRETE stopslip
  slipping=.false.

END ! of stopslip

END ! of dynamic
!
```

- LIST OF EQUIPMENT -

TERMINAL

! ?

END ! of terminal

END ! of program

G.2 CMD Command File

prepare /clear /all

output /clear T,FV,DX,dxd

set tstop=1

Appendix H LIST OF EQUIPMENT

H.1 Modal Testing of Wagon

H.1.1 Accelerometers

Channel	Manufacturer	Amplifier	Number	Calibration mV/g	Range g
1	PCB	PCB	6298	104.0	5
2	PCB	PCB	6299	100.7	5
3	PCB	PCB	6300	100.5	5
4	PCB	PCB	6301	103.0	5
5	PCB	PCB	6302	105.0	5
6	PCB	PCB	6303	103.9	5
7	PCB	PCB	6304	102.5	5
8	PCB	PCB	6305	101.7	5
9	PCB	PCB	6306	100.8	5
10	PCB	PCB	6307	103.3	5
11	VM-US	BBN	0430	103.0	5

H.1.2 Load Cell

Manufacturer	Amplifier	Number	Calibration	Range
LCS	KWS	TCE No B92	2	1 ton

H.1.3 Data Tape

Machine : Teac 16 channel data tape (ST1074)

Media : DAT cartridge

Input range : Accelerometer – 0.5V

: Load cell – 20 V

Output range : 5 V

H.1.4 Analogue to Digital

Mausy data analysis system by MeCalc

16 input channels

Anti-aliasing filters adjusted to sample frequency

H.2 Impact Test

H.2.5 Coupler Force

E-type with machined shank fitted with 200 Ohm strain gauges, Calibrated with 10 ton dead weight.

H.2.6 Coupler Displacement

HBM 200mm LVDT

H.2.7 Amplifier

HBM carrier wave. 10V full scale

H.2.8 Data Tape

Machine :Kyowa 14 channel data tape (ST1074)

Media : beta video cartridge

Input range : 10 V

Output range : 4 V