

# **OPERATIONAL GREENHOUSE GAS EMISSIONS OF PUBLIC TRANSPORTATION IN THE ETHEKWINI MUNICIPALITY**



**Alison Gopaul**

Submitted in fulfilment of the Master of Science in Engineering Degree,  
College of Agriculture, Engineering and Science,  
University of KwaZulu-Natal  
June 2015

Supervisor: Dr. E. Friedrich  
Co-supervisor: Prof. D.D. Stretch

## DECLARATION

I, ....., declare that

1. The research reported in this thesis, except where otherwise indicated, is my original research.
2. This thesis has not been submitted for any degree or examination at any other university.
3. This thesis does not contain other persons' data, pictures, graphs or other information, unless specifically acknowledged as being sourced from other persons.
4. This thesis does not contain other persons' writing, unless specifically acknowledged as being sourced from other researchers. Where other written sources have been quoted, then:
  - a. Their words have been re-written but the general information attributed to them has been referenced
  - b. Where their exact words have been used, then their writing has been placed in italics and inside quotation marks, and referenced.
5. This thesis does not contain text, graphics or tables copied and pasted from the Internet, unless specifically acknowledged, and the source being detailed in the thesis and in the References sections.

Signed

.....

As the candidate's Supervisor I agree/do not agree to the submission of this thesis.

Signed

.....

## **ACKNOWLEDGEMENTS**

I would like to express my most sincere appreciation to the following people, without whom this dissertation would not have been a success:

- The one true God, with whom all things are possible;
- Dr E. Friedrich, for her, professional guidance, unwavering commitment and support as my supervisor;
- My family and friends, for their continuous encouragement, patience and understanding of my absence throughout this study;
- Prof D.D. Stretch, for his dedication and time as my co-supervisor; and
- The eThekweni Transport Authority, Transport for Cape Town, Metrorail division of PRASA, Gibela Rail Consortium and Piotrans for assisting with required data.

## ABSTRACT

The transport sector is responsible for the production of approximately 23% of worldwide greenhouse gas (GHG) emissions, highlighting the responsibility and opportunity for efficient mobility. Sustainable measures must be adopted for GHG emission mitigation, as an attempt to reduce the effects of climate change. The lack of formal and reliable public transport (PT) systems in South Africa has prompted the proposal of integrated rapid public transport networks (IRPTNs) for implementation in 12 South African metropolitan municipalities, including the eThekweni Municipal Area (EMA). The aim is the provision of evolutionary PT systems that are accessible, affordable and safe, and will ultimately attract more users and induce a modal shift to minimise congestion on the road network.

Motivated by the shortage of carbon emission studies and scenario analyses in the transport sector, this study serves as a benchmark for the *GO!Durban* system – the IRPTN planned for the EMA. The integrated system is planned to be fully operational by 2027. The baseline carbon emissions of the Business-As-Usual (BAU) Scenario were compared with the ex-ante carbon emissions of the *GO!Durban* system in the year 2030, for several vehicle technology options.

Results showed that the implementation of *GO!Durban*, will decrease GHG emissions of the PT sector of the EMA by 54% to 60% in 2030. The results were partially validated by the monitored carbon credits study conducted on the *Rea Vaya* BRT in the City of Johannesburg, which achieved a 69% decrease in GHG emissions. This indicates the achievable success of *GO!Durban* on a significantly larger scale. The procurement of efficient vehicle technology is the key factor. The X'Trapolis Mega rolling stock with a regenerative braking system, is currently in manufacture for the *GO!Durban* system and latest European Emission Standard V buses are recommended for operation along bus routes. Further studies are advised, including investigating the cumulative emission reductions during implementation of *GO!Durban*, and incrementalism as an alternative way forward.

## **ABBREVIATIONS**

BRT – bus rapid transit

CF – carbon footprint

CO<sub>2</sub> – carbon dioxide

CO<sub>2</sub>e – carbon dioxide equivalents

EMA – eThekweni Municipal Area

ETA – eThekweni Transport Authority

GHG – greenhouse gas

IRPTN – integrated rapid public transport network

DoT – Department of Transport

NMT – non-motorised transport

NLTA – National Land Transport Act

POV – privately-owned vehicle

PRASA – Passenger Rail Agency of South Africa

PT – public transport

PTAP – Public Transport Action Plan

ROW – Right of way

RRT – rail rapid transit

TRP – Taxi Recapitalisation Plan

---

## LIST OF FIGURES

Figure 2-1: The Natural Greenhouse Effect (Le Treut et al., 2007).....	7
Figure 2-2: Global Temperature Increases from 2090-2099 (IPCC, 2007).....	8
Figure 2-3: Projected South African Emissions (Scenario Building Team, 2007) .....	13
Figure 2-4: GHGs Produced per Sector in eThekweni Municipality (EEO, 2011).....	14
Figure 2-5: Average Daily Vehicular Emissions in 2002 (US EPA, 2004) .....	18
Figure 2-6: Factors influencing Vehicle Emissions (URS NZL, 2008) .....	19
Figure 2-7: BRT Trunk Line with Feeders (Gray and Hoel, 1992).....	24
Figure 2-8: <i>Rea Vaya</i> BRT Station (City of Johannesburg, 2013).....	30
Figure 2-9: <i>MyCiTi</i> BRT Lane (CCT, 2013) .....	32
Figure 2-10: <i>MyCiTi</i> Bicycle Path (Transport for Cape Town, 2013).....	33
Figure 2-11: Visual Impression of RRT (RLM, 2015) .....	35
Figure 2-12: Leapfrogging and the Incremental Approach (Hitge and van Dijk, 2012) .....	37
Figure 3-1: Municipalities of KwaZulu-Natal (EM, 2014b) .....	42
Figure 3-2: Major Industrial Nodes (Barker, 2011).....	43
Figure 3-3: PT in West Street in 1898 (Jackson, 2003) .....	44
Figure 3-4: Existing PT Services and Nodes (ETA, 2005) .....	48
Figure 3-5: The Metrorail Network in eThekweni Municipality (EM, 2014b).....	49
Figure 3-6: Metrorail Routes (Bhotha, 2013).....	50
Figure 3-7: Metrorail Train (PRASA, 2007).....	51

---

Figure 3-8: Addition of 24 New Scania Buses to subsidised fleet (Masikane and Mkhize, 2012).....	52
Figure 3-9: People Mover Bus (Schilz, 2013) .....	52
Figure 3-10: Toyota Siyaya .....	53
Figure 3-11: Overview of Trunk, Feeder and Complementary Routes (Barker, 2011).....	56
Figure 3-12: Trunk Routes of the nine corridors of <i>GO!Durban</i> (EM, 2014b) .....	58
Figure 3-13: Visual Impression of the Bridge City Terminal (Barker, 2011).....	60
Figure 3-14: General cross-section of BRT lanes for <i>GO!Durban</i> (GOBA Consulting et al., 2012a).....	61
Figure 3-15: Conceptual Design of BRT Station for <i>GO!Durban</i> (Barker, 2011) .....	61
Figure 3-16: PRASA New Generation Rolling Stock (Barker, 2013) .....	62
Figure 3-17: NMT components of <i>GO!Durban</i> (EM, 2014b).....	63
Figure 4-1: Research Framework for Emme (Alvinsyah and Zulkati, 2005) .....	70
Figure 4-2: PT Passenger Travel Trend results from HTS 2008 .....	80
Figure 4-3: Conversion Factors for Annual <i>EMME/2</i> Outputs .....	81
Figure 5-1: Passengers Boarding PT modes in 2008 for Conversion Factors.....	89
Figure 5-2: Comparison of 2008 <i>EMME/2</i> and HTS Results.....	90
Figure 5-3: Projections of annual passengers boarding PT modes up to 2030 for the BAU Scenario.....	92
Figure 5-4: AM Peak Hour Vehicle Projections for the BAU Scenario (ETA, 2012b).....	93
Figure 5-5: Projected Total Trip Distances per Vehicle Category for the BAU Scenario ...	94
Figure 5-6: Projected Passenger-km per Vehicle Category for the BAU Scenario .....	95

---

---

Figure 5-7: Annual Passengers Projected for <i>GO!Durban</i> in 2030.....	97
Figure 5-8: AM Peak Hour Vehicle Projections for <i>GO!Durban</i> (ETA, 2012b).....	98
Figure 5-9: Annual Distance Travelled per Vehicle Category for the <i>GO!Durban</i> Scenario .....	99
Figure 5-10: 2030 Passenger-kilometres per Vehicle Category for the <i>GO!Durban</i> Scenario .....	100
Figure 6-1: Total Emissions for Option 1 of the BAU Scenario .....	103
Figure 6-2: Total Emissions for Option 2 of the BAU Scenario .....	104
Figure 6-3: Total Emissions for Option 3 of the BAU Scenario .....	105
Figure 6-4: Total Emissions Comparison for all Options of the BAU Scenario .....	107
Figure 6-5: Emission Split per Vehicle Category for all Options of the BAU Scenario .....	108
Figure 6-6: 2030 Emissions per Vehicle Category for Option 1 of the <i>GO!Durban</i> Scenario .....	110
Figure 6-7: 2030 Emissions per Vehicle Category for Option 2 of the <i>GO!Durban</i> Scenario .....	111
Figure 6-8: 2030 Emissions per Vehicle Category for Option 3 of the <i>GO!Durban</i> Scenario .....	112
Figure 6-9: 2030 Emissions Comparison for all Options of the <i>GO!Durban</i> Scenario .....	113
Figure 6-10: Vehicle Emissions Scenario Comparison for Option 1.....	115
Figure 6-11: 2030 Emission Scenario Comparison per Vehicle Category for Option 1 ...	116
Figure 6-12: Vehicle Emissions Scenario Comparison for Option 2.....	117
Figure 6-13: 2030 Emission Scenario Comparison per Vehicle Category for Option 2 ...	118

---



Figure 6-14: Vehicle Emissions Scenario Comparison for Option 3..... 119

Figure 6-15: 2030 Emission Scenario Comparison per Vehicle Category for Option 3 ... 120

Figure 6-16: 2030 Estimated Emission Reductions for all Options..... 121

Figure 6-17: Emissions Profile for the Phasing-in of *GO!Durban* and Phasing-out of existing PT services ..... 123

Figure 6-18: Overview of Total Emissions of the PT Sector during the shift to *GO!Durban* ..... 124

Figure 6-19: Sensitivity to Distance Driven by BAU and *GO!Durban* Scenario Vehicles..126

---

## LIST OF TABLES

Table 2-1: Example of Global Warming Potentials (adopted from IPCC, 2007) .....	6
Table 2-2: CO <sub>2</sub> Emissions for Light-Duty Vehicles (EC, 2015a).....	11
Table 2-3: Euro Emission Standards for Heavy-Duty Vehicles (Lindqvist, 2012) .....	12
Table 2-4: Modal split before and after the implementation of TransMilenio (Nair & Kumar, 2005).....	23
Table 2-5: The Incremental Development of <i>Rede Integrada de Transporte</i> in Curitiba (Tufts University, 2015) .....	38
Table 3-1: Anticipated operational year of <i>GO!Durban</i> Phases (EM, 2014b) .....	58
Table 4-1: Progress of TRP in KwaZulu-Natal (TSA, 2009).....	73
Table 4-2: Fuel Consumption Factors and Sources for Existing PT System .....	76
Table 4-3: Fuel Consumption Factors and Sources for <i>GO!Durban</i> .....	77
Table 4-4: Default Emission Factors (in grams per litre) (CDM, 2011).....	78
Table 4-5: Assumptions for each option of the BAU Scenario .....	83
Table 4-6: Assumptions for each option of <i>GO!Durban</i> .....	84
Table 6-1: 2030 Emissions per Vehicle Category for the <i>GO!Durban</i> Scenario .....	114
Table 6-2: Sensitivity to 5% and 10% variance in fuel consumption parameters for the BAU Scenario.....	125
Table 6-3: Sensitivity to 5% and 10% variance in fuel consumption parameters for the <i>GO!Durban</i> Scenario.....	125

---

## CONTENTS

DECLARATION.....	ii
ACKNOWLEDGEMENTS.....	iii
ABSTRACT .....	iv
ABBREVIATIONS .....	v
LIST OF FIGURES.....	vi
LIST OF TABLES.....	x
CHAPTER 1: INTRODUCTION.....	1
1.1 Background – climate change and development of the transportation sector.....	1
1.2 Motivation .....	1
1.3 Research Question .....	2
1.4 Aims and Objectives .....	2
1.5 Structure of Report.....	3
CHAPTER 2: LITERATURE REVIEW .....	5
2.1 Introduction.....	5
2.2 Climate Change and Transportation .....	5
2.2.1 Definitions and Basic Concepts .....	5
2.2.2 Overall and Local Effects of Climate Change .....	8
2.2.3 Carbon Footprint .....	9
2.2.4 Air Emissions from Transportation.....	10

---

2.2.5 Global GHG Emissions.....	12
2.3 The Public Transportation Sector.....	14
2.3.1 Vehicle Fuel Technology .....	15
2.3.2 Vehicle Emissions .....	17
2.3.3 Integrated Rapid Public Transport Networks (IRPTNs).....	19
2.3.4 World-renowned Success of BRT Systems .....	21
2.3.5 Advantages and Disadvantages of IRPTNs.....	23
2.4 International Case Studies of PT and Associated Emissions .....	25
2.4.1 <i>Metrobus</i> , Mexico City.....	25
2.4.2 Quality Bus Corridor, Dublin .....	26
2.4.3 Vehicle Technology .....	26
2.4.4 Summary.....	27
2.5 IRPTN as a Solution in South Africa .....	28
2.5.1 South African IRPTNs .....	29
2.5.2 Problems experienced with South African IRPTNs .....	35
2.5.3 Leapfrogging vs. the Incremental Approach .....	36
2.6 Increasing PT Ridership.....	39
2.7 Gaps in Knowledge and Research on IRPTNs and GHG Emissions.....	40
2.8 Summary .....	41
CHAPTER 3: CASE STUDY .....	42

---

---

3.1 The Current PT System .....	42
3.1.1 The eThekweni Municipality.....	42
3.1.2 History of PT in the eThekweni Municipality.....	44
3.1.3 Overview of the Existing Local PT System .....	47
3.1.4 Challenges in the Local PT Sector.....	54
3.2 <i>GO!Durban</i> .....	55
3.2.1 Objectives of <i>GO!Durban</i> .....	55
3.2.2 Overview of the Network .....	56
3.2.3 Trunk Routes.....	57
3.2.4 Phases of Implementation .....	58
3.2.5 Phase One of <i>GO!Durban</i> .....	59
3.3 Summary .....	64
CHAPTER 4: METHODOLOGY .....	65
4.1 Introduction.....	65
4.2 Approach Evaluation.....	65
4.2.1 Theoretical Approach .....	65
4.2.2 Case Study Approach.....	66
4.3 Scope of study .....	68
4.4 Data Collection .....	69
4.4.1 <i>INRO EMME/2</i> Transportation Forecasting Software.....	69

---

4.4.2 Existing PT System .....	72
4.4.3 The <i>GO!Durban</i> System .....	74
4.4.4 List of Emission and Energy Consumption Factors.....	75
4.5 Data Analysis.....	79
4.5.1 Conversion of AM Peak Hour Data to Annual Outputs.....	79
4.5.2 CO <sub>2</sub> e Emissions Comparison .....	82
4.5.3 Sensitivity Analysis .....	85
4.5.4 Limitations and Uncertainties.....	85
4.6 Summary .....	87
CHAPTER 5: DATA MODELING AND ANNUAL RESULTS.....	89
5.1 Introduction.....	89
5.2 The <i>EMME/2</i> 2008 Base-Year Model.....	89
5.3 PT Sector Projections for eThekweni Municipality .....	91
5.3.1 Existing PT System Scenario .....	91
5.3.2 The <i>GO!Durban</i> Scenario.....	96
5.4 Summary .....	101
CHAPTER 6: RESULTS AND DISCUSSION .....	102
6.1 Introduction.....	102
6.2 BAU Scenario .....	102
6.2.1 Option 1.....	102

---

---

6.2.2 Option 2.....	104
6.2.3 Option 3.....	105
6.2.4 Emissions Comparison.....	106
6.3 <i>GO!Durban</i> Scenario .....	109
6.3.1 Option 1.....	110
6.3.2 Option 2.....	111
6.3.3 Option 3.....	112
6.3.4 Emissions Comparison.....	113
6.4 Comparison of BAU and <i>GO!Durban</i> Scenarios.....	115
6.4.1 Option 1.....	115
6.4.2 Option 2.....	117
6.4.3 Option 3.....	119
6.4.4 Scenario Comparison.....	121
6.5 Sensitivity Analysis .....	124
6.6 Comparison with <i>Rea Vaya</i> Carbon Credits Study.....	126
6.7 Summary .....	127
CHAPTER 7: CONCLUSION .....	130
REFERENCES.....	132
APPENDIX A: NRCS TAXI RECAPTIALISATION PROGRAMME LIST .....	A
APPENDIX B: SAMPLE CO <sub>2</sub> e EMISSION CALCULATION.....	B

---

## CHAPTER 1

### INTRODUCTION

#### **1.1 Background – climate change and development of the transportation sector**

Global climate change is caused by the increase of energy-trapping gases (greenhouse gases) in the lower atmosphere, due to increasing urbanisation and human activity, such as fuel combustion and emissions from industries. Some of the effects of global climate change include: increases in temperature, freshwater depletion and land degradation. The impact and intensification of these effects have drawn more attention to the contribution of human activity to the current environmental crisis and preventing further destruction of the earth, has become a world-wide concern.

The constant growth of the human population and the demand for mobility will continuously lead to development in the transportation and supporting construction industries (McMichael et al., 2003). The substantial contribution of greenhouse gas (GHG) emissions by the global transportation sector highlights the necessity to address the environmental impacts of this sector. It is crucial that sustainable practices are adopted for transformation of the sector with attention to planning and implementation processes, to ensure no further irreversible damage is caused. The transport sector creates the opportunity for worldwide GHG mitigation. Moving towards a „greener future“, the carbon footprint is an environmental tool that, allows the impact of a project to be evaluated as a measure of its feasibility (Wiedmann and Minx, 2008). Carbon emission studies can assess and aid in an informed decision-making process.

#### **1.2 Motivation**

As stated by Minister of Transport, Mr Ndebele (Ndebele, 2011), the transport sector emits 13% of the total global GHG emissions, and transport-related emissions are expected to increase by 57% by 2030. The challenges faced by the existing public transport (PT) system in South Africa (SA), which is inefficient and unreliable, have prompted the transformation of PT. According to the Department of Transport, *“the concept of a modern bus rapid transit system is critical to the success of SA's transport systems. Local transport*



cannot work if it does not incorporate a good bus service that is accessible, affordable and attractive to a broad range of people across society” (City of Tshwane, 2013). Integrated Rapid Public Transport Networks (IRPTNs) to be implemented in 12 South African cities, include Bus Rapid Transit (BRT) and Rail Rapid Transit (RRT) with the purpose of improving service reliability, travel time and convenience. It aims to ultimately reduce the amount of privately-owned vehicles on the road, thereby decreasing the emissions of the transport sector (Levinson et al., 2002). The four phases of this revolutionary project shall be implemented in Durban over the next ten years, with an anticipated cost of R25 billion (Mbonambi, 2012). This new system was named *GO!Durban*. Infrastructure development of this magnitude needs to be of benefit to both the public and the environment. Limited carbon emission studies in SA and around the world, and the shortage of scenario analyses assessing the impact of projects like this have motivated this study.

### **1.3 Research Question**

The following research question has been formulated: What is the operational carbon footprint of the proposed local IRPTN (*GO!Durban*), and will the project reduce GHG emissions compared to the existing PT system?

### **1.4 Aim and Objectives**

The following aim and objectives are to be achieved by this study.

#### **Aim:**

- To investigate the carbon footprint (CF), existing methodology and tools for associated calculation and to investigate the implications of CF on the proposed vehicles and transportation network of the *GO!Durban* system;

#### **Objectives:**

- Research and gather information from local and international sources pertaining to:
  - CF concept, methodology and calculation tools for vehicle emissions;
  - Emissions from public transportation vehicles and electricity generation;

- IRPTNs implemented in South Africa (Johannesburg, Cape Town Nelson Mandela Bay and Rustenburg (to be implemented)); and
  - Methods to be considered in reducing the expected CF of the IRPTN.
- Review, compare and critically evaluate literature on a suitable method for calculating the CF of the vehicular emissions (IRPTN and current);
  - Use software programmes to model traffic of the current transport system and proposed flow of the *GO!Durban* system and develop a model to calculate emissions and estimate the CF;
  - Determine the CF of the emissions of the current public transport system in the eThekweni Municipal Area (EMA) and compare these to the expected emissions of the *GO!Durban* system; and
  - Examine the planning process of the *GO!Durban* system, study IRPTNs around SA and conduct an improvement analysis on the eThekweni IRPTN for GHG emission mitigation.

## 1.5 Structure of Report

This report is divided into six chapters, to allow for easy understanding and interpretation of the study. A brief description of each chapter is provided in the following sections.

**Chapter 1 (Introduction)** presents the background information and the motivation for conducting this study, as well as the aims and objectives which the remaining chapters are directed at achieving.

**Chapter 2 (Literature Review)** provides a greater insight into climate change, global GHG emissions, and the concept of “carbon footprint” and its importance. The transport sector is the main focus, with the introduction of rapid transit systems (and exploration of the worldwide applications). The provision of efficient public transportation services (IRPTNs) as a solution for reduced transportation emissions is explored. This chapter provides the theoretical background required for this study, using various sources of information.

**Chapter 3 (Case Study)** explores the history of PT in EM, the services and challenges of the existing system and the *GO!Durban* system as a solution. The proposed IRPTN to be implemented is studied to acquire a relation between the current PT system and the transformation offered by the *GO!Durban* system.

**Chapter 4 (Methodology)** describes the procedure followed when conducting both the theoretical and case study components. The scope of the study, limitations and uncertainties, as well as emission factors and sources, for the calculation of vehicular emissions, are provided.

**Chapter 5 (Data Modeling and Annual Results)** provides validation of the transport modeling and presents the conversion to annual data for the case study.

**Chapter 6 (Results and Discussion)** provides a clear representation of the results obtained in the case study and a critical analysis thereof. A comparative analysis of the existing PT system and *GO!Durban* was carried out.

**Chapter 7 (Conclusion)** summarises the main findings. The study is concluded by addressing the research question and presents overall recommendations.

## CHAPTER 2

### LITERATURE REVIEW

#### 2.1 Introduction

This chapter sets the theoretical background for the research undertaken for this study. It provides contextual knowledge and understanding through the investigation of the greenhouse effect, climate change, the transport sector and sustainable practice of Integrated Rapid Public Transport Networks (IRPTNs), and vehicle technology, as well as underlining knowledge gaps and shortcomings.

The transport sector is a major energy user and greenhouse gas (GHG) emitter contributing to climate change; from road and railway construction to vehicular usage. Mobility is a worldwide necessity; therefore, development within the sector must include adopting emission mitigation strategies. There are several factors contributing to the overall carbon footprint of a transport mode and these will be presented in the following sections.

#### 2.2 Climate Change and Transportation

This section provides insight into the energy sector with regard to the following areas:

- Climate Change and Global Effects; and
- Worldwide and South African GHG Emissions - pertaining to the transport sector.

##### 2.2.1 Definitions and Basic Concepts

Climate, often described as 'average weather', is defined by temperature, wind and precipitation, amongst many other parameters, over a minimum period of 30 years. The radiation balance influences the climate of the earth, namely changes in: incoming solar radiation, the amount of solar radiation reflected back into space (cloud cover, aerosols or distribution of vegetation) and long-wave radiation from earth (influenced by GHG concentrations) (Le Treut et al., 2007).

The greenhouse effect is the process whereby the solar radiation that warms and is absorbed by the earth's surface is released back into the atmosphere as infrared radiation.

This increase in temperature due to the presence of GHGs, such as, water vapour, carbon dioxide (CO<sub>2</sub>), chlorofluorocarbons (CFCs), halons, methane (CH<sub>4</sub>), tropospheric (ground-level) ozone (O<sub>3</sub>), and nitrous oxide (N<sub>2</sub>O), which absorb heat, without which planet earth would be more than 30°C cooler. Therefore, the greenhouse effect is natural and essential for life on earth (Arrhenius and Waltz, 1990).

Global Warming Potential (GWP) refers to the heat-absorbing ability and decay rate of GHG molecules of a certain gas. GWPs change over time depending on the concentration of GHGs in the atmosphere. It is measured in terms of carbon dioxide equivalents (CO<sub>2</sub>e), as multiples of the potential of CO<sub>2</sub>, which is used as the reference GHG due to its significant increase in the atmosphere. CO<sub>2</sub> it is the main GHG responsible for global warming. GWP shows the amount of heat trapped and future impacts of GHGs over a long time horizon, as indicated by Table 2-1 (IPCC, 2007).

**Table 2-1: Example of Global Warming Potentials (adopted from IPCC, 2007)**

<b>GHG</b>	<b>GWP (time horizon 100 years)</b>
Carbon dioxide (CO <sub>2</sub> )	1
Methane (CH <sub>4</sub> )	25
Nitrous oxide (N <sub>2</sub> O)	298
Hydrofluorocarbon-23 (CHF <sub>3</sub> )	14 800
Sulphur hexafluoride (SF <sub>6</sub> )	22 800
Perfluorocarbons (C <sub>2</sub> F <sub>6</sub> )	12 200

These gases act like the glass of a greenhouse; allowing light (solar radiation) in, but trapping the energy, preventing it from passing out (Arrhenius and Waltz, 1990), as illustrated in Figure 2-1.

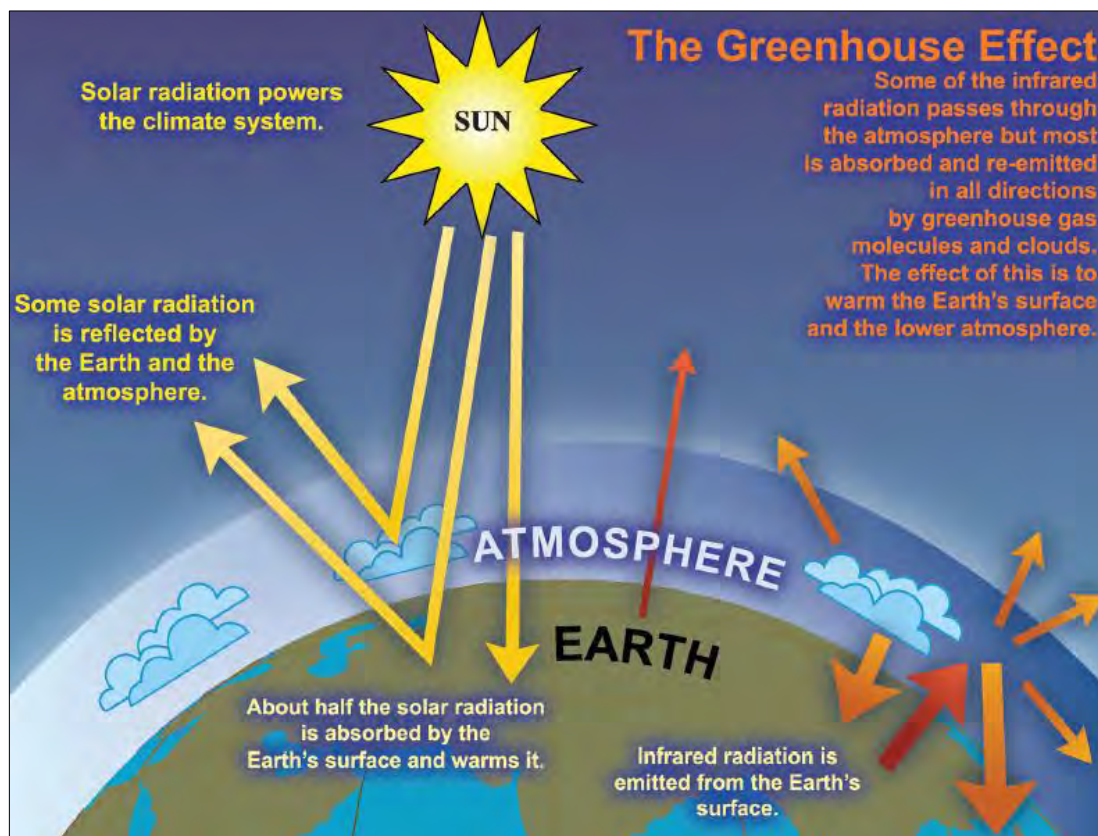

**Figure 2-1: The Natural Greenhouse Effect (Le Treut et al., 2007)**

The increase in GHG concentrations has, however, resulted in a global average increase in temperatures, known as climate change (Arrhenius and Waltz, 1990). Changes in temperatures from 1980-1999 were observed according to the GHG emissions produced. A global increase in surface temperature of 2.8°C is expected from 2090 to 2099, as depicted in Figure 2-2 (IPCC, 2007). There are many factors that amplify the greenhouse effect such as 'ice-albedo feedback', during which the snow or ice coverings melt revealing dark lands, causing more heat absorption and an unending cycle of increasing temperatures. The rise in global population and subsequent increase in demand and consumption has caused interference in the natural recharge of water sources and carbon, nitrogen and sulphur cycles. (Le Treut et al., 2007).

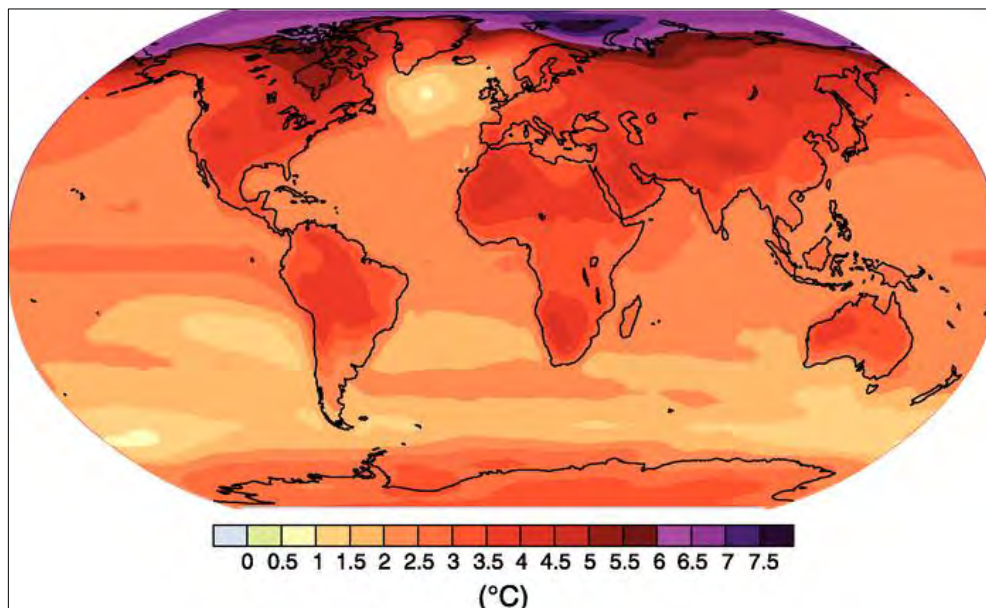

**Figure 2-2: Global Temperature Increases from 2090-2099 (IPCC, 2007)**

Anthropogenic climate change predominantly results from fossil fuel combustion (during which carbon is released) and deforestation (which inhibits the removal of carbon from the atmosphere and frees the carbon stored in forest vegetation). Transportation is a major anthropogenic activity which requires the combustion of significant quantities of fossil, resulting in the release of GHGs and contribution to climate change (Le Treut et al., 2007).

### **2.2.2 Overall and Local Effects of Climate Change**

The following worldwide effects are foreseeable, the impacts of which will be intensified by global warming (McMichael et al., 2003):

- Extreme weather conditions, intensified floods and droughts;
- Retreat of glaciers, thawing permafrost and melting sea ice in the arctic region and rises in sea levels;
- Shortage of freshwater;
- Disruption of ecosystems and extinction of flora and fauna species;
- Degradation of arable land;
- Malnutrition;
- Limited access to basic services and decreased life expectancy; and

- Spread of infectious disease.

The severity of these effects, and cumulative impacts, highlight the necessity of controlling GHG emissions.

#### *2.2.2.1 Climate Change in eThekweni Municipality, SA*

The city of Durban is situated on the east coast of Africa, within EM. Local trends indicate that Durban will experience many days of temperatures in excess of 30°C with heat waves and extreme weather disasters (Roberts, 2008). The issue of water availability will affect agriculture, productivity, food security, and of course, human health. A rise in sea level will also influence the function and usage of transport networks (Roberts, 2008). Some of the changes that may be experienced include (EM, 2014a):

- Increases in minimum and maximum temperatures of 1.5° and 2.5° in 2065 and 3° and 5° in 2100, respectively;
- Rises in sea level from 2.7cm per decade may further increase, exacerbating coastal erosion;
- Changes in rainfall patterns – an increase in occurrence and intensity of droughts and floods – will result in infrastructure damage;
- Degradation of arable land, reductions in staple crop yields and increases in livestock mortality rates;
- Heat stress and decreased air quality resulting in respiratory issues; and
- Disruption of ecosystems due to endangered grassland habitats unable to use the excessive concentrations of CO<sub>2</sub>.

#### **2.2.3 Carbon Footprint**

The Carbon Trust (2006) defines a carbon footprint (CF) as the total amount of GHG emissions for which an organisation is responsible. All GHG emissions are converted to CO<sub>2</sub>e, using the GHG Protocol and Emission Trading Scheme (with direct emissions from combustion and electricity generation, and indirect emissions from other activities). Although the standard unit for measurement is tonnes (t) of CO<sub>2</sub>e emitted, Matthews et al. (2008) claim that since CF is rooted in 'ecological footprint', it should be measured in total area of land needed to produce the level of human consumption.



The World Business Council for Sustainable Development (WBCSD) has specified different levels of emissions, called “tiers” or “scopes”, similar to those of the Carbon Trust, namely (Matthews et al., 2008):

- Scope 1: Direct emissions of an organisation (from factory and vehicles);
- Scope 2: Carbon emissions of energy inputs; and
- Scope 3 (optional): Other indirect activities (total supply chain emissions)

According Baldo et al. (2009), CF calculation methods can be classified as: general guidelines (such as International Organisation for Standardisation (ISO)), specific guidelines (indicating GHG calculation and monitoring) and calculation tools (for emissions of specific activities). Accounting guidelines include: the GHG Protocol of World Resource Institute, Publicly Available Specifications (PAS) 2050 of British Standard Institute, 2006 IPCC Guidelines for National GHG Inventories, Carbon Trust, and ISO 14064, 14025 and 14067 (Pandey et al., 2011).

The Carbon Trust (2006) recommends a five-step process for the calculation and reporting of business carbon emissions, namely: setting objectives, choosing a calculation approach and establishing boundaries, collecting data and emission factors calculation, and validation and reporting.

The CF tool is proving important for GHG management with developing methodologies (Pandey et al., 2011). It “*informs decision-making when considering reducing emissions of products and services*”, enabling a greater awareness of impacts on future generations; an awareness which may result in alternative sustainable practices within the transport sector (DBIS, 2011). Although a frequently used term, CF has not properly been defined within the scientific society. Confusion regarding measurement units and tiers should be addressed to ensure full understanding and a global method for calculation within each sector should be adopted so that proper legislation can be introduced (Baldo et al., 2009).

#### **2.2.4 Air Emissions from Transportation**

Exhaust gases resulting from fuel combustion include: CO<sub>2</sub> and hydrocarbons (HCs), nitrogen oxides (NO<sub>x</sub>), carbon monoxide (CO), sulphur dioxide (SO<sub>2</sub>), volatile organic compounds (VOCs) and particulates (DEA, 2009). In addition, chemical reactions occurring

---

in the atmosphere form secondary pollutants such as nitrogen dioxide (NO<sub>2</sub>), O<sub>3</sub>, nitric and sulphuric acid. Some of these gases are GHGs (CH<sub>4</sub>, CO<sub>2</sub>, and N<sub>2</sub>O) and others are air pollutants (NO<sub>x</sub>, SO<sub>x</sub> and particulates), with various environmental and health impacts. (DEA, 2009). The primary and secondary pollutants have different effects, a few of the negative ones include reducing oxygen flow in the bloodstream, aggravating respiratory problems and contributing to the formation of acid rain (US EPA, 2005).

The European Union (Euro) Emission Standards for vehicles, amongst others, are widely used to regulate exhaust gases produced, restricting vehicular air pollution (Delphi, 2014/2015). These include reductions of CO, HCs, CH<sub>4</sub>, NO<sub>x</sub>, particulate matter (PM) and particulate number (PN). The Euro Emission Standards are important for this study as they are the regulations used in SA. Developed for different vehicle categories, namely light-duty vehicles (below 3.5 tons) and heavy-duty vehicles (more than 3.5 tons such as buses and trucks), the Euro Emission Standards are denoted by arabic and roman numerals, respectively. Vehicles in operation may comply with older Euro Standards, however, new vehicle sales must comply with more stringent, updated regulations (Lindqvist, 2012).

Since the fuel consumption of a vehicle directly determines the quantity of CO<sub>2</sub> emitted, the latest Euro 5 and 6 Emission Standards, have placed restrictions on manufacturers for light-duty vehicles, as specified in Table 2-2 (EC, 2015a).

**Table 2-2: CO<sub>2</sub> Emissions for Light-Duty Vehicles (EC, 2015a)**

Year	Tested Fuel Consumption (L/100km)		Emission (gCO <sub>2</sub> /km)
	Petrol	Diesel	
<b>2009</b>	-	-	140
<b>2015</b>	5.6	4.9	130
<b>2020</b>	4.1	3.6	95

The different standards for diesel and petrol heavy-duty vehicles under Euro I to Euro VI regulations, are shown in Table 2-3. Previously, the European Stationary Cycle (ESC) and European Transient Cycle (ETC) tests were used, however, under Euro VI, the World Harmonised Transient Cycle (WHTC) and World Harmonised Stationary Cycle (WHSC) are stipulated (Lindqvist, 2012).

**Table 2-3: Euro Emission Standards for Heavy-Duty Vehicles (Lindqvist, 2012)**

	NOx (g/kWh)		THC <sup>1</sup> (g/kWh)		NMHC <sup>2</sup> (g/kWh)		PM (mg/kWh)		PN (#/kWh)	
	Diesel	Gas/Petrol	Diesel	Gas/Petrol	Diesel	Gas/Petrol	Diesel	Gas/Petrol	Diesel	Gas/Petrol
Euro I 1992	8.0	-	1.23	-	360/612	-	-	-	-	-
Euro II a 1996.10	7.0	-	1.1	-	250	-	-	-	-	-
Euro II b 1998.10	7.0	-	1.1	-	150	-	-	-	-	-
Euro III 2000.10	5.0 <sup>3</sup>	5.0	0.66 <sup>4</sup>	0.78	100/160 <sup>5</sup>	-	-	-	-	-
Euro IV 2005.10	3.5 <sup>3</sup>	3.5	0.46 <sup>4</sup>	0.55	20/30 <sup>5</sup>	-	-	-	-	-
Euro V 2008.10	2.0 <sup>3</sup>	2.0	0.46 <sup>4</sup>	0.55	20/30 <sup>5</sup>	30	-	-	-	-
Euro VI 2013.01	0.4/0.46 <sup>6</sup>	0.46	0.13/0.16 <sup>6</sup>	0.16	10/10 <sup>6</sup>	10	6x10 <sup>11</sup> /8x10 <sup>11</sup> <sup>6</sup>	-	-	-

<sup>1</sup>Total hydrocarbons (methane included); <sup>2</sup>Non-methane hydrocarbons; <sup>3</sup>Both ESC and ETC test cycle; <sup>4</sup>ESC test cycle only; <sup>5</sup>ESC and ETC test cycle respectively; <sup>6</sup>WHTC and WHSC test cycle respectively

With the aid of a new tool, VECTO, regulations will be proposed for the reporting and monitoring of CO<sub>2</sub> emissions from new heavy-duty vehicles. The improved transparency will enable the introduction of further legislation, such as limits on average CO<sub>2</sub> emissions, as with light-duty vehicles (EC, 2015b).

## 2.2.5 Global GHG Emissions

In 2004, total global GHG emissions reached 49 000 Mt CO<sub>2</sub>e (Scenario Building Team, 2007). The worldwide transport sector was responsible for 19% of total energy consumption and the production of 23% of energy-related CO<sub>2</sub> emissions. In 2013, CO<sub>2</sub> emissions from global fossil fuel consumption and cement production reached a high of 35 300 Mt (PBL NEAA, 2014). Privately-owned vehicles (cars) and trucks have been identified as the source of almost 75% of global transportation CO<sub>2</sub> emissions. This is expected to rise by 50% by 2030 and 80% by 2050 (OCED and IEA, 2009).

### 2.2.5.1 South African GHG Emissions

In 2004, SA produced 440 Mt CO<sub>2</sub>e, a contribution of 1% to the global total. In SA (Scenario Building Team, 2007), emissions per capita reached almost 10 t CO<sub>2</sub>e per person (2004), significantly higher than countries with greater populations such as China, and the global average of 7 t CO<sub>2</sub>e per person. Predictions in SA according to 'growth without constraints' assumptions (no carbon constraints or energy efficiency plans) have estimated 2050 emissions at 1 600 Mt CO<sub>2</sub>e, almost quadruple those of 2004. Figure 2-3 illustrates emissions per sector, according to coal to liquid (CTL), industrial process emission (IPE),

non-energy emissions (NEE), electricity, transport and industrial sectors (Scenario Building Team, 2007).

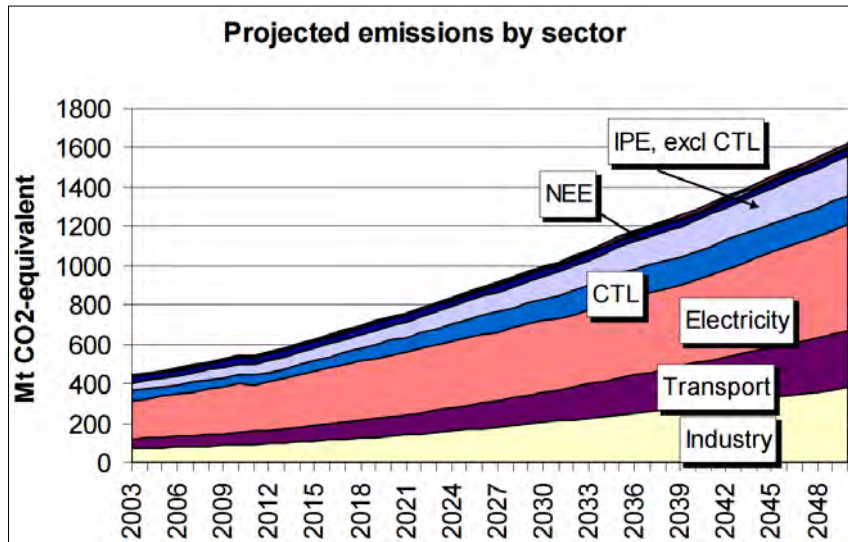

**Figure 2-3: Projected South African Emissions (Scenario Building Team, 2007)**

Agricultural, residential and commercial energy usage cannot be seen on this scale. It is evident that the transport and industrial sectors have the greatest projected increases over the next 30 years (Scenario Building Team, 2007). In SA, Euro Emissions Standards are predominantly used, with Euro 2 and Euro II regulations followed (Delphi, 2014/2015). In 2009, an excess of 8 M vehicles operated on South African roads, including 5.4 M private cars, 1.9 M light duty vehicles (bakkies), 321 000 trucks, 362 000 motorcycles, 283 000 minibus-taxis and 45 000 buses (DoT RSA, 2011).

This considerable contribution of transportation emissions to the worldwide GHG emissions, together with the rapid increase in transport energy (fuel) consumption, highlights the great opportunity to decrease national emissions through sustainable practices in the transport sector (Thambiran and Diab, 2011).

#### 2.2.5.2 GHG Emissions Produced in eThekweni Municipality

In 2011, the EM emitted 27 649 kt CO<sub>2</sub>e. 37% of measured emissions were produced by transport fuels (including petrol, diesel, jet fuel, marine diesel and fuel oil) in the transport sector and 32% by industry, as seen in Figure 2-4 (EEO, 2011).

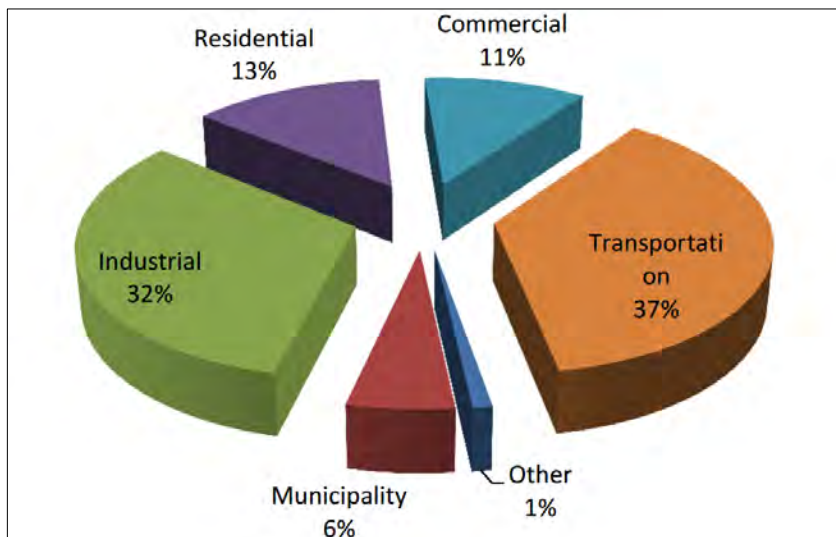

**Figure 2-4: GHGs Produced per Sector in eThekweni Municipality (EEO, 2011)**

Of the 37% emitted by the transport sector 34% is produced by transport by industry, 22% by fuel combustion (on-road and off-road mobile vehicles), 17% by rail, air and water transport systems, 14% residential, 12% commercial and 1% by movement of solid waste (EEO, 2011). Durban, the core city in the EM, has a privately-owned vehicle (POV) ratio of 189 cars in every 1000 people (189/1000), a value above the national average. This is indicative of the dependence on POVs and subsequent production of emissions (Thambiran and Diab, 2011).

### 2.3 The Public Transportation Sector

Transportation is defined as: *“the transfer of persons and or goods, in a vehicle or otherwise, between geographically separated places”* by road, railway, air and water systems (Steenbrink, 1974). Transportation is an essential component of the human way of life, economic development and growth of cities (Cox, 2010). Privatised and public transportation (PT) exists in cities. Private transportation is: *“POV – cars and motorcycles – operated for personal use, usually on publicly provided and operated streets”* (Gray and Hoel, 1992). A PT service, as defined by the National Land Transport Act (NLT Act) of 2009 (RSA, 2009) is: *“a scheduled or unscheduled service for the carriage of passengers by road or rail, whether subject to a contract or not, and where the service is provided for a fare or any other consideration or reward”*. Vuchic (Gray and Hoel, 1992) characterises PT modes by:

- Right-of-way (ROW) – degree of separation from other vehicles:
  - Mixed traffic, physically separated allowing grade crossings for pedestrians and vehicles, and ‘exclusive’ fully controlled ROW;
- Technology – mechanical features of vehicles:
  - Support of weight, guidance (steering and direction), control systems and engine technology; and
- Type of service (Gray and Hoel, 1992).

Rapid urbanisation has exacerbated the demands of the transport sector and many people lack access to affordable transportation and services. POVs have become a mark and instrument of the modern world. In an effort to combat congestion on roads and subsequent increases of vehicular emissions and decreased air quality, human mobility must be understood and the compatibility of development and sustainability within the transportation sector, addressed (Cox, 2010). The following sections will focus on PT, in particular the integrated PT intervention and vehicle technology.

### **2.3.1 Vehicle Fuel Technology**

In 1878, German engineer, Nicholas Otto, built the first internal combustion engine (ICE), powered by air-oil mixtures. This was followed by the invention of an automobile and later, petrol-fuelled engines, buses and double decker buses (Vuchic, 1981). Rapid population growth and urbanisation led to the expansion and upgrade of these technologies in the last 100 years, as cities around the world use different forms of PT. Therefore, the demand for PT increased, along with fossil fuel (petrol and diesel) consumption and associated GHG emissions.

Due to the nature of non-renewable fuels, factors such as oil supply and the environmental impact of fossil fuels have drawn attention to alternative fuels in recent years. Sought after solutions to the petroleum market include the electric engine (as electric vehicles can rely on renewable means of generation) and biofuels from sustainable farming practices (Cornell University, 2013). This section will focus on vehicle and fuel technology and vehicle emissions, which are relevant for PT.

#### *2.3.1.1 Vehicle Fuel Technology*

The following fuel technologies were studied:

---

- Crude oil-based (petrol and diesel);
- Compressed natural gas (CNG);
- Electric and hybrid technology; and
- Biofuels.

#### 2.3.1.1.1 Crude oil-based fuel

Crude oil, a naturally occurring fossil fuel, is refined to produce petrol and diesel. Diesel is easier to refine than petrol, however, further extractions are required to reduce pollutants of diesel to that of petrol. Containing more energy than petrol, diesel fuels in addition to a more efficient engine (which can be up to 40% more efficient than petrol) produces lower CO<sub>2</sub> emissions (EAMA, 2014). Although diesel contains more sulphur and produces more SO<sub>2</sub>, ultra-low sulphur diesel is more efficient than petrol, however, has greater NO<sub>x</sub> and PM emissions (de Jong et al., 2009).

#### 2.3.1.1.2 Compressed Natural Gas (CNG)

Also a fossil-based fuel, CNG contains 95% methane stored under high pressure. A CNG engine, operating the same way as a petrol engine, is less efficient than diesel engines, however, the usage of CNG reduces PM, NO<sub>x</sub> and HC pollutants. Petrol and diesel engines may be altered to run on natural gas, however, the latter may require a small amount of diesel (de Jong et al., 2009).

#### 2.3.1.1.3 Electric Vehicles

An electric motor converts electrical energy to mechanical energy and produces no emissions during operation. Hybrid electric vehicles (HEVs) are vehicles powered with the conventional ICE and an electric motor, which operate on fuels and the energy stored in the battery. This enables a reduction in tailpipe emissions as fuels burn under more stable conditions, emitting less pollutants and CO<sub>2</sub> (de Jong et al., 2009). Plug-in HEVs (PHEVs) however, may be charged at electric sources for which emissions produced by electricity generation must be considered. Emissions that occur at the source can be controlled much more easily, compared to those during travel (DoT RSA, 2011). In many countries such as SA, electricity generation is reliant on low-quality coal, therefore PHEVs are not a sustainable option and may result in higher transport-related emissions (Liu et al., 2012).

---

Electricity generated by renewable sources is an alternative, however, such options are currently limited in SA.

#### 2.3.1.1.4 Biofuels

Biofuels are organic matter (HCs) produced into fuels by chemical reactions and can be classified as (Cornell University, 2013):

- First generation – from sugars, starches, oils and animal fats (biodiesel, bio-alcohols, ethanol, and biogas);
- Second generation – made from agricultural waste or non-food crops;
- Third generation – made from algae and biomass sources; and
- Fourth generation – made from genetically engineered crops.

Depending on the biofuel composition, exhaust emissions are slightly lower than fossil fuels and overall GHGs, significantly lower. There are, however, other environmental issues associated with biofuels, such as the use of genetically modified species and shortage of agricultural lands.

#### **2.3.2 Vehicle Emissions**

Vehicle emissions, as mentioned in Section 2.2.4, can be classified as exhaust (due to fuel combustion), evaporative and non-exhaust PM (due to aging of tyres, brakes and road surface) emissions (Boutler et al., 2009). Exhaust emissions include hot exhaust (while the engine is running during driving or idling) and cold start (during the ‘warm-up’ of the engine to optimum operating temperature). Evaporative emissions are categorised as: running losses (while vehicle is operational), diurnal (temperature fluctuations heat fuel), hot soak (while hot engine cools after switched off), and refuelling (when gas forced out of tank during filling) (MECA, 2010). As modelled by the US EPA, the average emissions of a typical car, for a day in the year 2002 is shown in Figure 2-5.



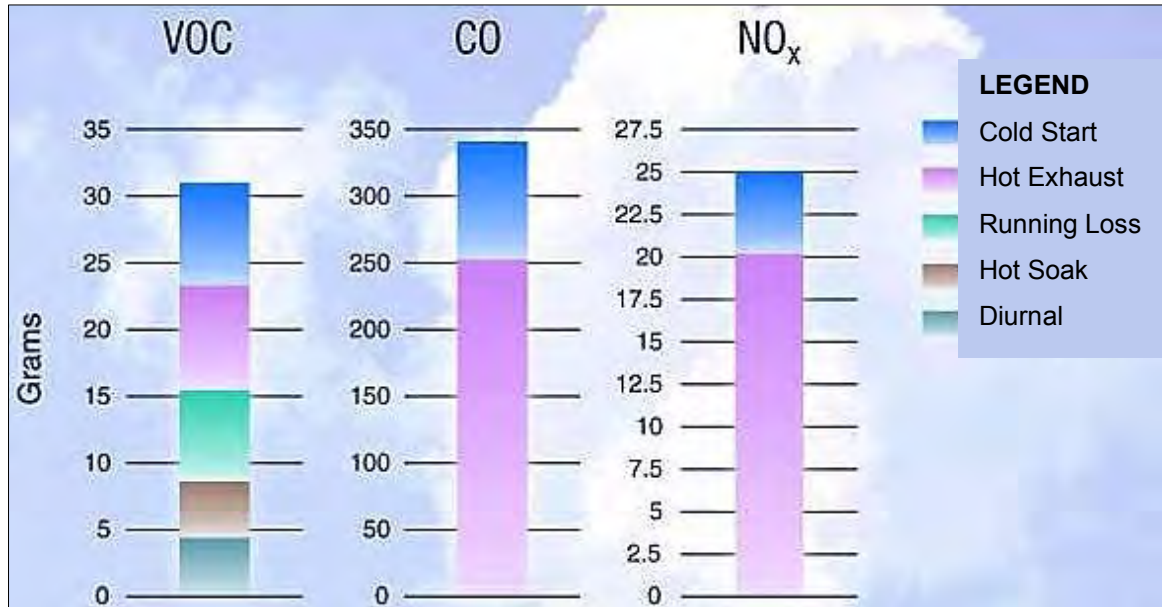
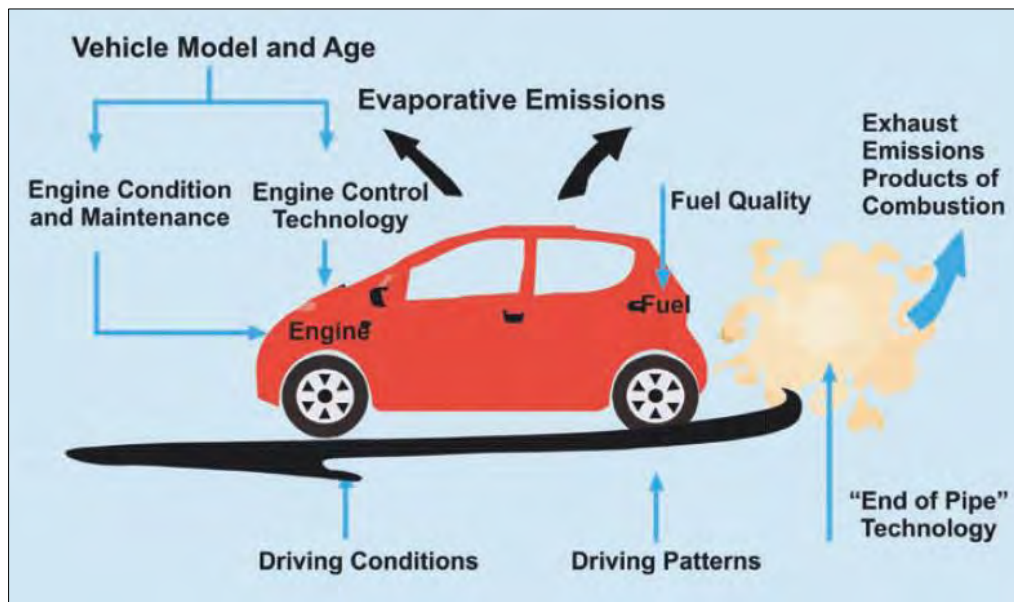

**Figure 2-5: Average Daily Vehicular Emissions in 2002 (US EPA, 2004)**

As indicated, CO emissions are significantly higher than VOCs and NO<sub>x</sub>. Exhaust emissions comprise almost 97% of total emissions, with 26% resulting from cold start and 71% produced during the running of the vehicle (hot exhaust). A great amount of energy is required to heat the engine in a cold environment. As modelled by US EPA, evaporative emissions are negligible, indicating the impact of low temperatures on vehicle emissions (US EPA, 2004). In warmer environments, higher temperatures will result in greater running losses, diurnal and hot soak emissions.

### 2.3.2.1 Influences on Vehicle Emissions

Several factors affect the quantity and type of vehicle pollutants (including GHGs), some of which are noted in Figure 2-6.



**Figure 2-6: Factors influencing Vehicle Emissions (URS NZL, 2008)**

Driving technique (including operating speeds), topography, fuel type and road and weather conditions have a significant impact on fuel consumption and emissions. Elevated CO<sub>2</sub> emissions are observed during congestion due to stationary periods (stalling), constant braking and acceleration of the driver and longer running time of the engine. A reduction in CO<sub>2</sub> can be seen with a shorter travel time at higher speeds (Pretorius and Vanderschuren, 2012). Vehicle characteristics that play a role are: the overall weight (vehicle load), vehicle technology (engine design) and age. An aging fleet will produce greater emissions therefore, maintenance is crucial for optimum functionality (de Jong et al., 2009).

The different vehicle technologies studied in this section are used for PT. The population growth rate experienced in modern cities and increased PT demand, lead to the expansion of PT from individual vehicles to operational networks, comprising several types of vehicles.

### **2.3.3 Integrated Rapid Public Transport Networks (IRPTNs)**

An integrated PT network, as defined by the NLTA of 2009 (RSA, 2009) is: *“a system in a particular area that integrates PT services between modes, with through-ticketing and other appropriate mechanisms to provide users of the system to travel from their origins to destinations in a seamless manner”*. PT, also referred to as transit, offering an alternate means of transportation, has the potential to reduce traffic and congestion, pollution and

accidents on roads. Rapid transit is a high-capacity quality rail or bus system that is fast, comfortable and convenient, with separated railway lines or lanes which operate along fixed routes and schedules for a fare (Litman, 2014).

### *2.3.3.1 Bus Rapid Transit (BRT)*

BRT, as defined by the Institute for Transportation and Development Policy (ITDP) is: “A *high-quality bus-based transit system that delivers fast, comfortable, and cost-effective urban mobility through the provision of segregated ROW infrastructure, rapid and frequent operations, and excellence in marketing and customer service*” (Wright and Hook, 2007). According to Mejia-Dugand et al. (2012) “*BRT does not represent transformation as such, but a means to achieve transformation*”.

Components of successful BRT systems include (Wright and Hook, 2007):

- Exclusive ROW lanes located in the centre of the roadway;
- Rapid boarding and alighting;
- Intelligent transportation systems (ITS);
- Fare integration between corridors;
- Pre-board fare collection services;
- Safe stations along the routes (in the centre of the roadway);
- Modal integration at stations and terminals;
- Clear route maps, signage, and real-time information displayed; and
- Low emission vehicle technologies with universal access.

While imitating the service of a rail-based transit system at 4-20 times less than the cost of rail, BRT can encompass many route arrangements, providing passengers with alternatives, unlike rail (Wright and Hook, 2007). BRT aims to make travel by bus more attractive than other modes, and in so doing, tackle transport demand, congestion and delays, creates the potential to significantly impact transport emissions (McDonnell et al., 2008). Faster and more convenient than standard bus services, BRT avoids delays caused by on-board ticketing and operation in mixed-traffic lanes. A standard BRT system will accommodate 13 000 passengers per hour per direction, typically at speeds of 23-30 kilometres per hour (km/hr) (Wright and Hook, 2007). Integration with other modes is an essential component, such as bicycle lanes and pedestrian paths, which encourage non-motorised transport

---

(NMT) (Goodman et al., 2005). The primary purpose of the BRT is to solve mobility issues; it may also resolve many other issues not initially targeted (Mejia-Dugand et al., 2012).

### 2.3.3.2 Rail Rapid Transit (RRT)

Quality Rail Services are efficient in moving large populations and contribute to a city's livability. High performance articulated rail services – with speed, capacity and reliability – are electrically powered. With significant start-up costs and low ridership, rail systems may appear to be the unfavourable option, however, benefits are revealed with time as patronage increases and costs decrease. Rail services are free of vehicle emissions however, the means of electricity generation must be considered as point-source pollution for this mode (Litman, 2014).

### 2.3.4 World-renowned Success of BRT Systems

BRT systems that have shown the greatest success in transformation and reduction of GHGs of the transportation sector are:

- *Rede Integrada de Transporte* – Curitiba, Brazil; and
- *TransMilenio* – Bogotá, Colombia.

According to Wright and Hook (2007), Curitiba and Bogotá are the only two 'full' BRT systems in the world, the characteristics upon which the definition of BRT has been established. These case studies have been included to demonstrate the success of BRT in countries with population and travel services to South Africa.

#### 2.3.4.1 *Rede Integrada de Transporte, Curitiba*

The development of Curitiba was anticipated to radiate from the city centre; however, the growth in POVs and traffic influenced plans. The Transport Master Plan integrated transport and land-use planning and in 1965 Curitiba was expanded along specified linear corridors. Traffic was reduced through: restricted vehicle access to the city centre, reduced public parking and creation of pedestrian facilities. The BRT system consists of residential feeder routes for five main channels to the city centre, served by minibuses and standard buses. Reserved lanes provide ROW and buses are not governed by traffic signals. Tickets are to be purchased at stations and passengers are to wait on the elevated platform for buses.

Sheltered wheel chair friendly ramps that extend from the bus to the platform enable rapid loading and unloading (Goodman et al., 2005).

The reliability of buses, some of which are scheduled to run every 90 seconds, is very attractive to users. Almost 70% of daily commuters use the system to travel to work. Curitiba uses 30% less fuel per person compared to 8 other cities of equal size in Brazil. Curitiba spends 10% of their income on transportation, which is much lower than the national average. In 1991, a survey showed that the BRT in Curitiba annually eliminated 27 million (M) POV trips and subsequent litres of fuel. The BRT caused a modal shift of 28% from POVs and subsequent significant reductions in emissions from the transport sector. Today, the BRT makes Curitiba a more convenient city with 1 100 buses running 12 500 trips daily, and more than 50 times the amount of passengers compared to 20 years ago (Goodman et al., 2005).

#### 2.3.4.2 *TransMilenio, Bogotá*

The capital city of Colombia is Bogotá, with an area of 340 km<sup>2</sup> and population of over 7 M Bogotáns. In 1990, Bogotá's insufficient road maintenance and congested roads resulted in increasing pollution levels and occurrence of accidents. Continuous road-widening and construction of flyovers did not improve traffic, and worsened road maintenance (Nair and Kumar, 2005).

In 1998, the Japanese International Cooperation Agency (JICA) approached Bogotá with a 'Transportation Master Plan'. It included a metro system, urban highway and pedestrian sidewalks. Bogotá however, had another plan – *TransMilenio* – which was designed to enable the mobility of people, instead of accommodating vehicles. Completed in 54 months, *TransMilenio* consists of separate bus lanes, sheltered stations, newer buses with increased capacity, pre-boarding ticket facilities and rapid boarding (Nair and Kumar, 2005). The BRT system with the *Pedestrian* and a 300km dedicated bicycle pathway has increased non-motorised modal usage and discouraged the use of POVs. The *Pedestrian* functions not only as an NMT facility, but similar to shopping malls, contains stores and serves as a tourist attraction (Nair and Kumar, 2005). *TransMilenio* serves 45 000 passengers per hour per direction; the highest capacity BRT system (Wright and Hook, 2007). As seen in Table 2-4, the implementation of *TransMilenio* has drastically improved the modal share of NMT by 4% and reduced POV usage by 5%.

**Table 2-4: Modal split before and after the implementation of TransMilenio (Nair & Kumar, 2005)**

Modal Share	1998	2002
<b>PT (transit)</b>	72%	73%
<b>POV</b>	16%	11%
<b>NMT</b>	9%	13%
<b>Other</b>	3%	3%
<b>Average Travel Time</b>	48 min	42 min
<b>Perception of PT System</b>	5.56/10	6.94/10

The perception of PT has improved by 13,8%, enabling a greater usage thereof. A favourable increase in the use of the *Pedestrian* and decrease in the use of POVs is evident. This has enabled higher bus travelling speeds, reducing travel time of *TransMilenio*. The overall emissions in Bogotá have experienced a subsequent reduction of 28% in CO levels. This rapid decrease of CO levels offers the most benefit of the transport system development in Bogotá. O<sub>3</sub> and NO<sub>2</sub> levels have remained relatively constant over the implementation process.

Injuries along the *TransMilenio* routes have decreased from 18 for the year of 1998 to a mere 4 in 2002. The implementation of *TransMilenio*, together with education campaigns, strict law enforcement and restricted access of cars in the city have resulted in reduced traffic injuries and deaths (Cohen, 2008).

### **2.3.5 Advantages and Disadvantages of IRPTNs**

BRT and rail systems should ideally work together for optimum route coverage to provide an attractive network which is accessible to all. Competition between services should be minimised (Litman, 2014). As with any network, many benefits and difficulties are experienced with IRPTNs.

#### *2.3.5.1 Advantages of IRPTNs*

The literature (Litman, 2014) based on case studies specified benefits of IRT including:

- User safety, comfort and convenience (independence);
- Fare integration provides cost-effective services (saving on POV costs);
- Reduced road vehicles improves congestion, accident occurrence, demand for road reserve and maintenance costs;
- Optimization of NMT facilities between nodes;
- Energy efficiency and emission reduction; and
- Strategic promotion of urban development.

#### 2.3.5.2 Disadvantages of IRPTNs

The difficulties experienced in IRPT systems include (Gray and Hoel, 1992):

- High initial costs and government investment;
- Significant land-use impacts (space required for exclusive lanes);
- Long implementation periods and mandatory maintenance;
- Extensive planning, management and communication required for success;
- Organisation and promotion of integrated services and availability of information;
- High level of security and monitoring for necessary crime prevention; and
- Prevalent negative public perception of PT.

The type of bus network, shown in Figure 2-7, is a trunk line with feeders. A major disadvantage of this design is the compulsory change of vehicle category by a passenger along a journey, and cost implication of the requirement of universal access vehicles (Gray and Hoel, 1992).

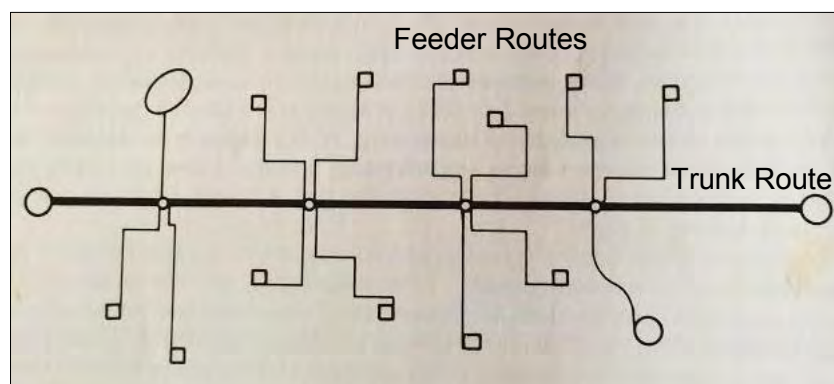

**Figure 2-7: BRT Trunk Line with Feeders (Gray and Hoel, 1992)**

These networks have different configurations with diverse vehicle types, resulting in varying vehicle emissions. The following section will present worldwide case studies focussing on these emissions.

## **2.4 International Case Studies of PT and Associated Emissions**

In order to compare different IRPTNs and resultant GHG emissions, a series of international studies have been reviewed. The studies presented in the following sections create a greater understanding of the influence of PT networks on the reduction of GHG emissions from transportation, namely:

- The implementation of BRT;
- Modal shift towards PT; and
- Advanced vehicle technology.

### **2.4.1 Metrobus, Mexico City**

The BRT system, *Metrobus*, was implemented in *Mexico City* in June 2005 along 20km of Insurgentes Avenue (a principal arterial route). Minibuses were previously a popular mode with many of the fleet age exceeding six years, without proper maintenance. *Metrobus* introduced new technology articulate diesel buses with high capacity. Wöhrnschimmel et al. (2008) evaluated the exposure of commuters to levels of suspended particles (PM<sub>2.5</sub> and PM<sub>10</sub>), benzene, CO and other VOCs. Measurements inside PT vehicles were conducted before and after the implementation of a BRT system. Using least squares regression models, results showed reductions in commuter exposure from minibuses to CO, benzene and PM<sub>2.5</sub> of 45%, 69% and 30%, respectively. Due to the introduction of more buses on the road network, exposure to pollutants from buses increased from 20% to 54%, and exposure to VOCs are due to emissions from surrounding vehicles on the roads (Wöhrnschimmel et al., 2008). In addition, buses operating in exclusive lanes do not adhere to traffic signals and have higher operating speeds due to ROW. More efficient fuel consumption and less emissions are achieved due to fewer stops (McDonnell et al., 2008). The results showed that the BRT system was successful as a means of reducing the impact of air pollutants and should be considered the cleaner alternative with respect to commuter health.



---

### 2.4.2 Quality Bus Corridor, Dublin

McDonnell et al. (2008) investigated the introduction of PT priority policies for the decrease of transport GHG emissions during peak travel, particularly CO<sub>2</sub> emissions due to modal shift. These included reserved bus lanes and allocated bus fleet with scheduled services. The study was carried out on a Quality Bus Corridor (QBC) Exclusive Bus Lane in Dublin, Ireland, which was introduced in 1999. Population travel patterns and vehicular usage, as well as, peak traffic counts (used to generate modal share) were used to estimate CO<sub>2</sub> emissions. A baseline year was established and four scenarios applied to evaluate the impact of the QBC, namely (McDonnell et al., 2008):

- 'Build QBC';
- 'Not build QBC';
- 15% modal shift from POVs to implemented QBC; and
- 29% modal shift from POVs to implemented QBC.

In Scenario 1, which follows actual events from 1998 to 2003, an overall decrease of emissions is observed, as car emissions drop by 10 kt CO<sub>2</sub> and bus emissions increase by 1, 5 kt CO<sub>2</sub>. In the absence of the QBC (Scenario 2), emissions would have been 50% higher in 2012 than that of Scenario 1. A modal shift induced by higher quality services (Scenario 3 and 4) can further reduce emissions. The environmental impact of the QBC serves as an indication of the importance of policy in PT for curbing CO<sub>2</sub> emissions of the sector (McDonnell et al., 2008).

### 2.4.3 Vehicle Technology

Studies in Montreal (Zahabi et al., 2012), indicated that average GHG emissions (from total travel) were lowest at central business areas and suburban households with cars (due to dependence on POVs) that emit more GHG than those in the central business district (CBD). The study showed that households with one adult have significantly less emissions than those with many adults. Low income households emit 51% less GHGs as limited POVs encourage car-pools and the use of PT.

When suggesting GHG reduction methods, vehicle fleet and rolling stock improvements were considered according to the following scenarios: current GHG emissions caused by

existing technology, upgrading buses to hybrids, replacing trains with electric trains, complete replacement of all PT fleet, as well as projecting fuel efficiency based on existing trends. The use of hybrid buses results in an 11% decrease in GHG releases, electric trains emit negligible GHG emission and a combination of the two measures enables a 32% reduction. Although PT accessibility is more crucial (from a social perspective) than implementing the use of greener vehicles, Zahabi et al. (2012) state that the best ways to reduce GHG emissions would be to improve fuel efficiency of POV and making PT more accessible, but first and foremost POV fuel efficiencies need to be tackled. Policies aimed at fuel efficient vehicles that target POV trips and high income households should be enforced.

By implementing reliable PT services, the dependence on POVs might decrease. Urban planning plays an important role in reducing GHG emissions in the transport sector by creating densely populated areas with proper access to PT. According to Zahabi et al. (2012) a GHG reduction of 7% could be achieved by improving fuel efficiency with respect to POVs, and PT emissions could be lowered by 32% if electric trains and hybrid buses replaced current modes.

Chan et al. (2013) investigated the GHG emissions of using alternate fuels such as biodiesel (with a ratio of canola oil to petroleum diesel of 20:80), CNG and diesel electric hybrid. An analysis was done along the *Cote-des-Neiges* (CDN) transit corridor in Montreal, Canada, which links two bus and one train station, on the Route 165 bus which showed that majority of GHGs were emitted during operation. CNG produced the least emissions in the manufacturing process from natural gas and diesel-electric hybrid technology emitted the least GHG during operational phases. Overall, hybrid technology produced the least emissions, followed by CNG, biodiesel and diesel-fuelled buses. Changing to biodiesel, however, did not offer GHG savings as significant as expected (Chan et al., 2013).

#### **2.4.4 Summary**

Several solutions are adopted around the world to address challenges in the PT sector. The development of PT systems occur at different rates depending on the potential, requirements and most appropriate changes. There is much to be learned from the advance of PT systems throughout the world and these studies provide an indication of what is

achievable through various options. The studies reviewed agree that CO<sub>2</sub> emissions can be lowered by PT, through the implementation of PT interventions. Crozet and Lopez-Ruiz (2012) concluded that the immediate introduction of new technology is the most effective way to reduce emissions from transportation. Thereafter, human choices and behaviour towards available options must be addressed.

## **2.5 IRPTN as a Solution in South Africa**

According to Hitge and van Dijk (2012), the limited investment in the transport sector in SA over the past 30 years has prompted urgency for improvement. The growth of the informal PT sector and operation of unreliable road vehicles, in conjunction with limited bus and rail lines, make up the current PT system. Low quality inefficient PT services have resulted in increased purchases and usage of POVs, further reducing PT ridership (Hitge and van Dijk, 2012). In an effort to combat the increasing issue of congestion in many municipalities, ROW bus lanes have been implemented along major freeways, along with additional lanes and flyovers. The addition of lanes however, does not alleviate the issue of congestion but creates a greater road capacity to accommodate more vehicles (Thambiran and Diab, 2011). The most effective solution according to the South African transportation sector is the IRPTN.

The South African Department of Transport (DoT) introduced the Public Transport Action Plan (PTAP) in 2007 to put the PT Strategy into practice. It focuses on two key areas: accelerated modal upgrades and IRPTNs in up to 12 cities and 6 districts in SA over a 20-year period. The three phases envisaged were (DoT RSA, 2007):

- Phase 1 (2007 – 2010) – Accelerated modal recovery and catalytic IRPTN project;
- Phase 2 (2010 – 2014) – Promote and deliver basic networks; and
- Phase 3 (2014 – 2020) – Advance and sustain accessible networks.

Phase 1 was directed at modal upgrades specifically for the improvement of services for the 2010 FIFA World Cup, which forms part of the final plan to advance, promote and sustain basic services and networks to be achieved with Phase 2 and 3. This section will provide insight on the following:

- Operational IRPTNs in South Africa including:
-

- 
- *Rea Vaya BRT system and Gautrain Rapid Rail Link* – Gauteng Province;
  - *MyCiTi* – Cape Town IRT;
  - *Libhongolethu Integrated PT System* – Nelson Mandela Bay Municipality; and
  - *Rustenburg Rapid Transit* (planning phases) – North West Province.
- Issues experienced in implementation;
  - The incremental approach; and
  - Increasing PT ridership.

### 2.5.1 South African IRPTNs

The general modal split of POV: PT in large South African cities is 50:50 (Onatu, 2011). Private commuters usually carry few or no passengers, causing an increase in cars on the road with occupancy of one, escalating congestion (Onatu, 2011). Unlike the minibus-taxi industry, passenger rail and some bus services of SA are subsidised by the government. Instead of the services complementing each other, in many instances, they are in competition for commuters. The PT systems of SA are similar to those of Latin America, which is why the planned BRT systems of SA have been modeled on the successful South American BRT systems such as Bogota (AA, 2013).

The National Transport Master Plan (NATMAP 2050) goal is: “*to develop a dynamic long-term sustainable land-use or multi-modal transportation systems framework for the development of network infrastructure facilities, interchange terminal facilities and service delivery*” (DoT RSA, 2010), An integrated PT network, as defined by the NLTA of 2009 (RSA, 2009) is: “*A system in a particular area that integrates PT services between modes, with through-ticketing and other appropriate mechanisms to provide users of the system to travel from their origins to destinations in a seamless manner*”. Many municipalities focused on BRT as the first step towards an integrated PT system.

The benefits of BRT include: safe and secure accessible PT, job creation and containment of urban sprawl, and densification along corridors and sustainable transport (AA, 2013). Cities such as Johannesburg, Cape Town and Nelson Mandela Bay introduced IRPTNs with a central BRT component (*Rea Vaya*, *MyCiTi* and the *Libhongolethu*, respectively) to provide PT services for the 2010 FIFA Soccer World Cup and years after. The IRPTNs

consist of trunk BRTs and rail services with feeder routes and involved the procurement of new vehicles, which required bus operators to bid for jobs (for inclusion in the system). Conventional formal bus businesses could bid, however, the informal operators had to formalise their business or merge with a company, to bid (Schalekamp and Behrens, 2010).

#### 2.5.1.1 *Rea Vaya BRT System in the City of Johannesburg*

*Rea Vaya* which means “we are going” was the first BRT system to be implemented in Southern Africa. Phase 1A of *Rea Vaya*, which accommodates commuters between Soweto (Thokozo Park) and Ellis Park, began operation in September 2009 to address issues of mobility and alleviate severe congestion. Consisting of 143 Euro IV buses serving 25.5 km of BRT trunk route, Phase 1A includes 27 stations, 3 complementary and 5 feeder routes (DoT RSA, 2011). An additional 34km of trunk routes were added for Phase 1B. In total, there are 277 Euro IV clean buses with universal access in operation at 48 stations and 59km of trunk routes. 488 jobs have been created at the stations alone. A station is shown in Figure 2-8. The construction of Phase 1C of *Rea Vaya* which will create 5 700 jobs, began in 2014 and is to be completed by 2017. It includes 16km of trunk routes, two feeder and three complementary routes and 30 km of walking and cycling paths. *Rea Vaya*'s long-term plan is the coverage of 330 kms, for 80% of Johannesburg's population at a total cost of R6.7 billion (City of Johannesburg, 2013).



**Figure 2-8: *Rea Vaya* BRT Station (City of Johannesburg, 2013)**

For application of carbon finance by Clean Development Mechanism (CDM) for emission mitigation, a carbon study was conducted on the *Rea Vaya* BRT system. The outcome of the project resulted in its selection as one of 31 finalists in the 2014 City Climate Leadership Awards for sustainability projects. It was run by Siemens and C40 Cities Climate Leadership Group, who acknowledge leadership in climate action (City of Johannesburg, 2014).

In addition to the BRT system, the *Gautrain Rapid Rail Link* was launched by July 2007 (DoT RSA, 2011), also in the City of Johannesburg. With anticipated increases in the use of OR Tambo International Airport, a railway link was chosen to promote PT usage and provide convenient travel for local and international airport users. It was intended to decrease travel time between Tshwane and Johannesburg – a congested link, by attracting people away from POVs (Walters, 2013). Consisting of an 80km route with stations, and 36 feeder routes serviced by *Gautrain* buses, the total cost of the *Gautrain* was R25.2 billion (DoT RSA, 2011). According to the *Gautrain* CEO, Jack van der Merwe, 100 000 passenger trips were expected per day on the *Gautrain*. This would have led to a CO<sub>2</sub> reduction of 15 000 tons per annum (DoT RSA, 2011), the result of which could not be confirmed.

#### *2.5.1.2 Cape Town's Integrated Rapid Transit (IRT) System*

The IRT planned for Cape Town focused on integration of PT services, and passenger rail as a fundamental mode. *MyCiTi*, primarily a BRT system, provides exclusive services to the residents of Cape Town (CCT, 2013). A segregated bus lane contains stations located at intervals and avoids the congestion of mixed-traffic (unreserved) lanes, as shown in Figure 2-9.



**Figure 2-9: MyCiTi BRT Lane (CCT, 2013)**

Buses initially introduced adhere to Euro IV standards and newer vehicles to Euro V, accommodating passengers with special needs. Phase 1A of *MyCiTi* includes the Inner City and the Blaauwberg – Dunoon – Atlantis Corridor and Phase 1B (completion of services) and Phase 2 extend to Khayelitsha and Mitchells Plain (CCT, 2013). Cape Town introduced park-and-ride facilities at 26 railway stations throughout the city, in order to attract commuters to rail services. A total of R47 M was spent on upgrading the 26 stations (including Mitchell’s Plain, Somerset West, Century City and Claremont) chosen according to usage and distance from city centre (DoT RSA, 2011).

The system includes a NMT route from Table View to Cape Town city centre, bicycle paths and upgraded pedestrian walks, as shown in Figure 2-10. Buses have a designated storage place for bicycles which may be transported for free, if not occupied (CCT, 2013).



**Figure 2-10: MyCiTi Bicycle Path (Transport for Cape Town, 2013)**

Cape Town's transportation demand management (TDM) measures include: the promotion of higher occupancy vehicles, support policies and tax incentives, and investigation of road user charges (DoT RSA, 2011). These interventions will encourage GHG savings and enable a more environmentally friendly PT system.

#### *2.5.1.3 Libhongolethu Integrated PT System (IPTS) in Nelson Mandela Bay*

Situated in the Eastern Cape, the Nelson Mandela Bay Metropolitan Municipality (NMBMM), is the second largest metropolitan in area, after Ekurhuleni in Gauteng (NMBMM, 2015). It comprises three urban nodes Port Elizabeth, Uitenhage and Despatch, which house 90% of the total population. In 2007, PT comprised 40% of all trips, 75% of which was by minibus-taxi. With a population of 1.3M, the structural design of the BRT planned for NMBMM was based on the operational BRT of Pereira, Colombia, with the most similar population of 750 000 (NMMM, 2007). In NMBMM, however, the restriction on physical space for road reserve posed as a significant challenge. The BRT system had to be incorporated into the existing road network and limitations were created as the ROW lane had to go through the city centre, the arrangement of which was already established. This led to further issues,



as lanes were narrower and did not provide adequate turning space. In addition, on-street parking, pedestrian and loading zones were reduced, negatively impacting business (Siyongwana and Binza, 2012).

Under the assumption that the intention was only to improve PT services for the 2010 FIFA Soccer World Cup, the minibus-taxi industry claimed that they were not adequately informed or included in the process, which led to public resistance and social unrest. The ROW lane became an integrated 'BRT lite' lane used by all PT services and the 25 buses procured for the system went into storage for 24 months after the World Cup. Although the bus industry was not drastically altered by the BRT system, the minibus-taxi industry rejected a name that excluded them. Therefore, the IRPTN was restructured around the minibus-taxi industry, the backbone of PT in the NMMM (Siyongwana and Binza, 2012). The ROW lanes that were constructed for the BRT were "dug up" because they were not properly planned (SABC, 2012). After addressing the previous errors, *Libhongolethu*, meaning "Our pride", the IPTS with seven routes between Port Elizabeth, Uitenhage and Despatch began operation on a cash payment system (NMBT, 2012).

#### *2.5.1.4 Rustenburg Rapid Transit (RRT)*

Rustenburg is one of the fastest growing cities in SA, with great potential for economic growth due to mining opportunities (RLM, 2015). The *Rustenburg Rapid Transit* (RRT) system from Phoekeng and Kanana to Central Rustenburg, in the North West Province, will serve 200 000 commuters at the estimated cost of R3 billion. The intention is to have the network fully operational as soon as possible, an effort to encourage increase accessibility and development patterns by construction along specific corridors (DoT RSA, 2011). The system will include BRT integrated with bus services for outlying areas and long distance services. Enclosed stations will be located in the middle of the reserved BRT lane as shown in Figure 2-11 (RLM, 2015).



**Figure 2-11: Visual Impression of RRT (RLM, 2015)**

The RRT will enable efficient transportation, improve the quality of life, and reduce the environmental impact and congestion on roads (RLM, 2015).

### **2.5.2 Problems experienced with South African IRPTNs**

Arguing that participation is essential to the development process, Siyongwana and Binza (2012) list inadequate planning and communication as the main challenges in the difficult implementation of the NMBMM BRT system. Communication from the prefeasibility to engagement, implementation and project completion phases, is crucial for success. An approach that considers and addresses the concerns and needs of those affected and incorporates them into decision, must be adopted, instead of merely determining policy, notifying the public and enforcing it. Communication between providers and the affected people must be more effective and result in an acceptable outcome (Siyongwana and Binza, 2012).

Several problems have been experienced with the taxi industry, who delayed project progress, claiming that they were not adequately informed and would be at a disadvantage economically. An issue is the new negotiations that arise for each phase implemented, as a variety of operating companies would manage the network, leading to managerial problems. BRT difficulties include attempts to formalise the informal minibus-taxi industry, in an effort to integrate services with the system (Walters, 2013). Several violent protests in Johannesburg, Cape Town and NMBMM erupted with the informal sector claiming that they

were inadequately informed on the BRT plans, which would lead to a decrease in employment opportunities (Schalekamp and Behrens, 2010).

Months before the launch of Rea Vaya, violent threats were made as it was believed that a loss of jobs would result. The United Taxi Association Forum applied to stop the launch and South African National Taxi Council (SANTACO) claimed that they were left out of the negotiations and violent shootings took place at the Soweto trunk and feeder routes. Police guards were positioned at the stations and negotiations continued for 14 months until September 2010. Passenger safety influenced low ridership levels of the system (Venter, 2013), which in turn resulted in higher BRT emissions. In addition, the negatively perception of safety of the minibus-taxi industry was associated with the BRT system in NMBMM, and resulted in support from low income users only (Siyongwana and Binza, 2012).

### **2.5.3 Leapfrogging vs. the Incremental Approach**

Leapfrogging is a concept that introduces a complete transformation through large, expensive jumps. It is an intensive approach, aimed at a selected area, which simultaneously addresses all issues in a system at a single geographical location. In contrast, Hitge and van Dijk (2012) summarise the incremental approach as a strategy that does not solve all challenges in one step instead, tackles one problem at a time, enabling assessment at each level and adjustment before further action is taken. Incrementalism allows small steps to be taken, on a large scale in order to achieve the final goal (Hitge and van Dijk, 2012).

Leapfrogging and incrementalism use different methods, namely a few intensively planned expensive jumps versus many small steps, respectively, to achieve the same result, as shown in Figure 2-12. In terms of transport planning, leapfrogging focuses on a direct move to a high quality system by fully implementing one corridor at a time. The impact of this approach will only be seen at the end of the phase and might be irreversible or too expensive to correct. In cities that do not immediately benefit from improvement, poor PT services continue and may further deteriorate and reduce ridership. The demand for PT ridership has to be built up after the intervention is implemented. In contrast, the incremental approach addresses once issue at a time, such as formalising the minibus-taxi industry, thereby improving all systems in the same way and retaining patronage (Hitge and van Dijk, 2012).

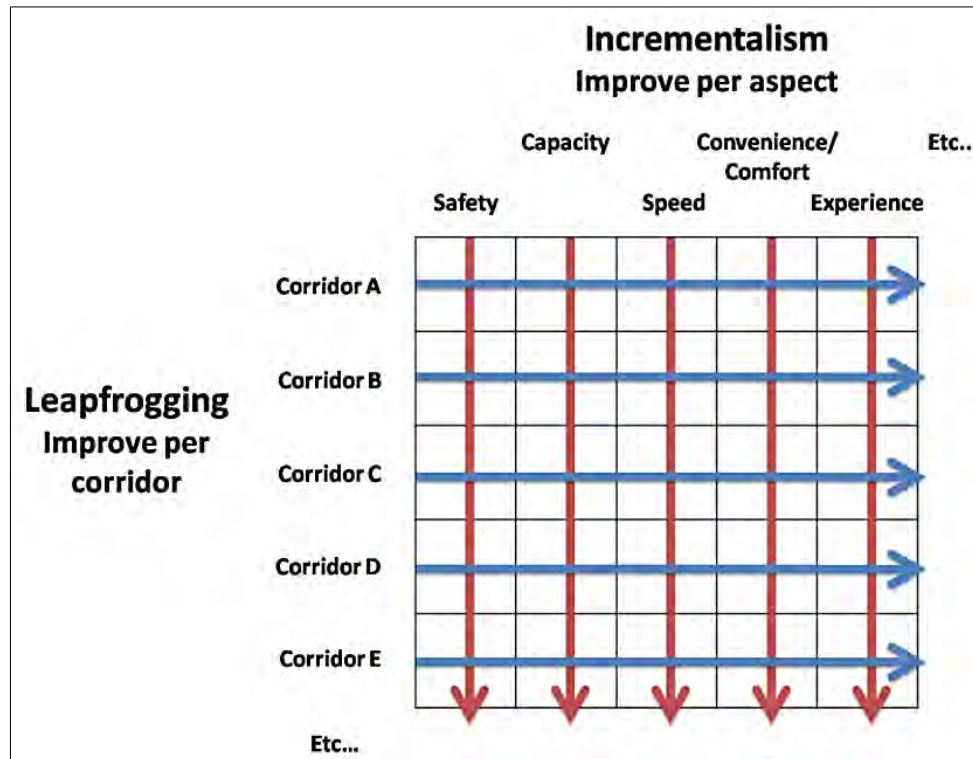

**Figure 2-12: Leapfrogging and the Incremental Approach (Hitge and van Dijk, 2012)**

Advantages of incrementalism include all-round (universal) development, limited funding requirement for immediate action, development according to passenger needs, enables improvement of individual challenges and change is seen faster. This approach might produce a positive response from the minibus-taxi industry in terms of introducing new policy. Disadvantages may include extended duration of implementation of an entire system in one area, continuation of remaining challenges until addressed in the next step, all changes cannot be achieved by incrementalism for a limited period of investment (Hitge and van Dijk, 2012).

Advantages of leapfrogging include quicker visible progress in a single area, capitalise on available funding for a political period to transform system, economic benefit of complete development in an area (less disturbance compared to phases), new system eliminates challenges of old. The disadvantages of leapfrogging are that a significant financial investment is required and that the improvement happens in only one area at a time and long waiting periods exist for others. There are high expectations of the system and the

impacts are seen only after implementation, and at this stage it would be too costly to correct (Hitge and van Dijk, 2012).

Hitge and van Dijk (2012) highlight the implementation of the *Rede Integrada de Transporte* in Curitiba, which progressed over 30 years through incrementalism, by development in technology and altering the needs of passengers with land use changes. These increments can be seen in Table 2-5.

**Table 2-5: The Incremental Development of *Rede Integrada de Transporte* in Curitiba (Tufts University, 2015)**

1970s	1980s	1990s	2000s	2010
Bus stop shelters	Tube stations			Real time information
Conventional buses	Articulated buses	Bi-articulated buses	Cleaner buses	B100 articulated buses
Open terminals	Closed terminals (paid area)			
Paper and coin based ticketing (manual)			Electronic ticketing	
Trunk-and-feeder services	+Inter-neighborhood +Direct (Ligerinho)	+Special services		+Overtaking at busway stations
Urban services		Metropolitan services		
	Dispatch at terminals			Real time control

Cities around the world try to duplicate the resulting system, without consideration of the transitions experienced in establishing the finished BRT system. Hitge and van Dijk (2012) claim that SA “*tends to focus on leapfrogging to a desired end state – the ultimate design – without considering potential transitional improvements*” and argue that incrementalism is required for the implementation of an advanced PT system. In NMBMM, if a system had been created for integration into the city, to suit its specific transport needs, a functional BRT network would exist. Instead, a BRT similar to that established in Pereira was selected and fully implemented, without adaptation to or consideration of the existing road networks. The unusable system was a failure and required further investment for correction, which may have been prevented with components of incrementalism, which provides flexibility to respond to uncertain events.

The City of Cape Town is using leapfrogging to implement one corridor at a time for success in a chosen area. Phase 1 of *MyCiTi* accommodates approximately 15% of the city's residents. A benefit is the technology development for the shift from car to PT usage. The remaining areas, however, with inadequate capacity and decreasing level of PT service, favour the usage of POVs. A possible application of incrementalism (or an alternative) to *MyCiTi* includes: improving driving through training and enforcement in the minibus-taxi sector, increasing security technology for bus and railway travel, improving the running schedule of bus and rail services, and integrating fares and ticket stations and equipment into the system. Other steps include the replacement of vehicles, road and facility upgrades and improvements for convenience (Hitge and van Dijk, 2012). This is simply an example of applying the incremental approach to a South African IRPTN, which should be investigated as part of the planning process from inception, for the most effective implementation method. Monitoring and feedback received by transport departments record issues experienced in municipalities, which assists in the incremental approach.

Both approaches have benefits and detriments depending on the circumstances of each project, therefore, both approaches must be investigated and evaluated for the best decision. Larger issues or stabilisation of the system can be addressed first through incrementalism, as it allows for focus on one aspect across all corridors. Figure 2-12 shows how a combination of the two could be used to ease into the transition of completely transforming a geographic location. With adequate finances and management, leapfrogging may be successful in larger cities, however smaller cities should adopt the incremental approach to individual challenges (Hitge and van Dijk, 2012). In terms of GHG emissions, these approaches have different consequences. In the incremental approach, emission savings would be achieved across the board in one instance, whereas emission savings for the leapfrog approach would be achieved over much longer periods of time.

## **2.6 Increasing PT Ridership**

A study conducted by Chen and Wang (2012) showed that an increased ridership of PT services through policy for PT priority will have the most desired outcome with regard to reducing emissions. The promotion of modal shift to PT (over the control of POV purchases and reduction of average travel distances through planned urban development) could reduce CO<sub>2</sub> emissions from transportation by 24.13% in 2020 in a city in China (Chen and

---

Wang, 2012). As well as improving service quality of PT facilities, high ridership and possible modal shifts towards PT can be achieved by the following measures:

- Walking and bicycle (NMT) facilities;
- Provision of park and ride facilities (Cuenot et al., 2012);
- Promotion of PT as cheaper and less harmful to the environment; and
- Address of negative public perception to PT (Nair and Kumar, 2005).

Results indicated that POVs produced the most GHGs, in comparison to other modes.

If POV usage is made more expensive or inferior to PT services, usage will be discouraged.

The following options are available for implementation (Chen and Wang, 2012):

- Restricting POV usage on specific days of the week (similar to Bogota);
- Enforcing car-free zones;
- More stringent POV monitoring (vehicle licenses and roadworthiness) and penalties;
- Disincentives on POV purchases (increased taxes) and increasing fuel levy;
- Implementing or increasing parking fees; and
- Implementing road user charges on POV.

It is essential that the provision of reliable PT services is ensured prior to enforcing further measures to decrease POV usage, as timing of interventions is vital.

## **2.7 Gaps in Knowledge and Research on IRPTNs and GHG Emissions**

Worldwide studies have been conducted on the success of rapid transportation systems as a means of increasing accessibility and moving large populations along specified corridors. The success of emission reductions of the PT sector and corresponding environmental impact in Brazil and Colombia has inspired several similar systems throughout the world. The definition of BRT follows the characteristics of the established systems in Curitiba and Bogota, due to their achievement in the transformation of the cities. BRT presents a solution which is cheaper to implement than RRT.

One of the significant results of IRPTNs globally is the reduction in GHG emissions. Only a few studies, however, have been conducted in developing countries in effort to quantify

these reductions. In SA, a Carbon Credits study was only conducted the *Rea Vaya* BRT system. Similarly, this study, also measuring the reductions in PT emissions, serves as the first of its kind carbon calculation for the *GO!Durban* IRPTN to be implemented in the EM (in comparison to the previous system). The scarcity of carbon emission studies within the PT sector of SA must be highlighted, in particular, limited scenario analyses with respect to GHG in this field. This underlines the requirement for this study and further studies to be undertaken, in order to understand the potential impact for improved decision-making. As a means of easier transition from project inception to successful PT interventions, the incremental approach must be considered and properly assessed against leapfrogging, and the environmental effects of both evaluated.

## **2.8 Summary**

The irreversible effects of climate change are increasing globally and cannot be ignored. Emission regulations must be applied world-wide and mitigative measures, together with adaptation to change, must be adopted. Although transportation is essential to the modern world, the impacts of the sector are rapidly increasing, pushing beyond 25% of global emissions. Therefore, the transport sector creates the opportunity to reduce worldwide emissions on a large scale.

In countries with disorganised, ineffective PT systems, travel by POVs has become the safe, reliable choice. Local and international case studies show that the provision of effective PT services can ensure mobility of passengers (stability of the economy and improved quality of life through better access), reduce transportation costs and encourage the use of PT. There is, however, an absence of GHG emission studies in many large municipalities in SA. Carbon studies serve as an indicator of environmental impact and project viability for informed decision-making. This study serves as an attempt to fill the gap with regard to the EM.

Many challenges have been experienced with the implementation of BRTs in SA and around the world, and there is much to be learned from these in ensuring the success of *GO!Durban*. Although government commitment and initial investment of rapid PT systems are high, if followed through with proper management, enforcement and disincentives for POV usage, safe, affordable access to PT can be provided and the reduction of GHG emissions enabled.



## CHAPTER 3

### CASE STUDY – PT IN eTHEKWINI MUNICIPALITY

This chapter presents the local context of PT. It investigates the existing condition of the PT system and the IRPTN as the solution. A brief history of the local PT system is also included, as well as the details of the planned new system.

#### 3.1 The Current PT System

This section will provide insight on the history of PT in the EM, the resulting PT sector and subsequent problems experienced with the existing services.

##### 3.1.1 The eThekwini Municipality

KwaZulu-Natal (KZN) is located on the east coast of South Africa, as shown in Figure 3-1.



Figure 3-1: Municipalities of KwaZulu-Natal (EM, 2014b)

19.8% (10.69 M) of the South African population resides in KZN (Statistics South Africa, 2014). Of the eleven municipalities encompassed by the province, eThekweni is classified as the only metropolitan municipality (LGH, 2012). Although it is the smallest municipality by area, it contains almost a third of KZN's population. Spanning approximately 2297 km<sup>2</sup>, the eThekweni Municipal Area (EMA) is 45% rural, 30% peri-urban and 25% urban. The EMA extends from Tongaat in the north to Umkomaas in the south and Cato Ridge in the west and to the coastline in the east. Durban is the largest port and city on the east coast of Africa with a municipal area of 2300 km<sup>2</sup> (EM, 2014b).

Major industrial and employment attractions are shown in Figure 3-2. In addition to Cato Ridge in the west, there are Pinetown and New Germany (NG) in the west, Phoenix Industrial area in the north, the South Durban Basin (SDB) and the Durban CBD.

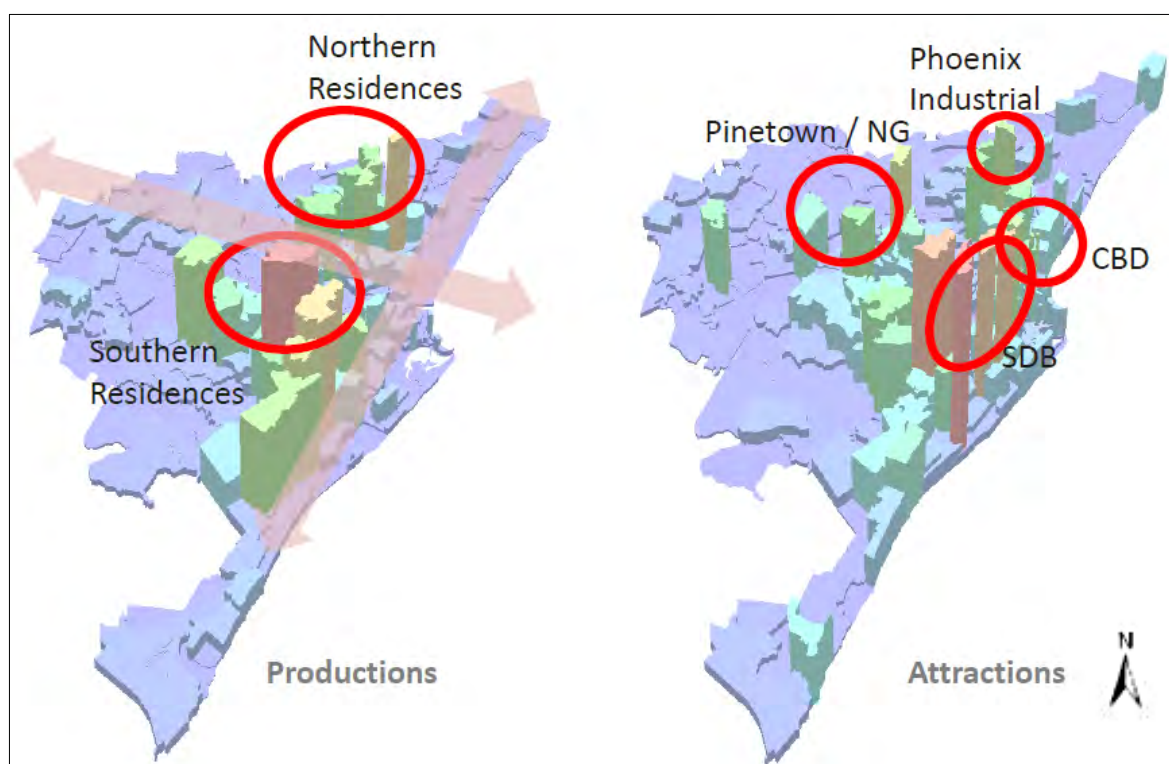

**Figure 3-2: Major Industrial Nodes (Barker, 2011)**

The point of confluence of the north-south corridor and the western corridor, Durban CBD, is a major PT node.

### 3.1.2 History of PT in the eThekweni Municipality

The first form of PT in Durban was a coach service between Durban and Pietermaritzburg, started by John Dare in 1860. It was named *Perseverance* because the journey took an entire day. A horse coach service began in the CBD in 1870, followed by horse-drawn double decker trams in 1880. PT services operating in 1898 in West Street (now Dr Pixley KaSeme Street), CBD can be seen in Figure 3-3. Competitive services by Collins and Murray later combined to form Durban Borough Tramways Company, which was bought out by Durban Municipality in 1899 (Jackson, 2003).



**Figure 3-3: PT in West Street in 1898 (Jackson, 2003)**

Imported electric trams began operation in 1902 and by 1910 Durban Municipal Transport Department built tram bodies with imported motors. Truck buses – trucks adapted to carry passengers - were introduced in 1919, the forerunners of several buses. The first petrol and diesel – engine buses were received in 1925 and 1934, respectively (Jackson, 2003). PT policy dates back to the Motor Carrier Transportation Act of 1930, which required drivers to acquire Motor Carrier Certificates from the Local Transport Board in order to transport a maximum of four passengers. The quota restricting the number of permits issued per year lead to illegal operations (Schalekamp and Behrens, 2010).

The implementation of Apartheid policies (1948–1994), which introduced racial segregation, created long commuting distances between areas. Low quality and low coverage services encouraged the operation of minibus-taxi services and although unsafe and unsustainable, commuters have turned to this mode for mobility (Prozzi, et al., 2002). After the introduction of minibuses, in 1984 the South African Black Taxi Association and Transport Deregulation Act of 1988 issued 1453 permits. This number increased by 2537% over the next five years to 38317, reaching 50 000 minibuses nationally. Minibuses were later phased out over four years and racial segregation of bus services, implemented. In 1987 Durban Transport introduced the Mynah Bus Service with 21-seater Mercedes Benz buses. The end of Apartheid was followed by the development and approval of the White Paper on National Transport Policy in 1996 for the improvement of transport operations and proposed transport integration systems (Schalekamp and Behrens, 2010).

In 2003 Durban Transport was sold to the Remnant (Pty) Ltd Alton Coach Africa Consortium. Privatisation and profit-oriented services have resulted, associated with low levels of service, unstable government subsidies and reduced ridership (Jackson, 2003). The legacy of the apartheid era has greatly influenced PT in SA and is still being addressed today. Bearing this in mind, the significant impact on fuel usage and emissions was not a major concern in the sector (Prozzi et al., 2002). To keep up with global regulations, however, the usage of lead-based petrol was completely discontinued by 2006, advancing vehicular technology. This led to the introduction of Euro 2 and Euro II Emission Standards for pollution control technology, such as catalytic converters, in vehicles in SA. Previous vehicles could maintain operation, however all new vehicles were in adherence to the new specifications (Thambiran and Diab, 2011).

With the decrease in quality of PT services and increasing subsidies, the DoT introduced the “Fundamental Restructuring of Durban’s PT System” as priority in 1999. The aim was the improvement of service quality by the development of a cost effective strategy (ETA, 2005). National Land Transport Transition Act of 2000 (NLTTA), later replaced by the National Land Transport Act of 2009 (Act 5 of 2009), defined responsibilities of government. The eThekweni Transport Authority (ETA) was established in 2004 to manage the provision of PT services in the EMA. The PT Plan (PTP) of 2005, as part of the Integrated Transport Plan for 2005-2010, specifies long-term strategic planning providing direction for short-term planning. It documents the following implementation strategies (ETA, 2005):

- 
- Rail Strategy:
    - Rail investment for north-south corridor;
    - New rail spur line to Bridge City;
    - Upgrade and Revitalisation of Chatsworth Rail Service;
    - Marketing of north-south PT corridor system; and
    - New Kings Park Rail Station.
  - Bus Strategy:
    - Introduce feeder-distribution services (formalisation of appropriate minibus-taxi services); and
    - Remove or reposition bus services in direct competition with rail services.
  - Minibus-taxi Strategy:
    - Regulate and control operations;
    - Remove/reposition services duplicated in rail services; and
    - Improve infrastructure and operating conditions for existing services.
  - NMT strategy to implement cycling-development projects; and
  - Provision of universal access vehicles.

The PTAP (2007) is an extension of the PT Strategy aiming to address the need for high quality PT services and PTP (2005) in SA in three phases. The focus of Phase 1 is accelerated modal recovery interventions including provision for the 2010 FIFA World Cup in host cities. It involved a fast-track programme over four years (2007-2010) including the following plans (DoT RSA, 2007):

- Taxi Recapitalisation Plan (TRP);
- Passenger Rail Plan; and
- Commuter Bus Transformation Plan.

It was planned that by 2009/10, 75 000 unroadworthy minibus-taxi must be 'scrapped' under the TRP and replaced by new vehicles. The TRP is an intervention introduced by government in October 2006 to bring about safe, effective services. It involves the scrapping of old minibus-taxis for an allowance and voluntary replacement with new vehicles (which are approved by the South African Bureau of Standards). The Rail Plan measures the

---

developments in rolling stock and infrastructure required to increase – service reliability, station passenger access and quality of service. Included in the 2 000 rail coaches must be upgraded (rolling stock refurbishment) the following upgrades were classified as high priority in KZN: Reunion Station, Avoca signals and new Umgeni Bridge line (DoT RSA, 2007). The bus plan included the transfer of bus contracts to metropolitan transport authorities and subsidisation to distance-based (instead of passenger-based). In addition, 30% of contracted bus services were to adhere to contract vehicles specifications. All upgrades were to be done in accordance with universal access standards. Plans for NMT and public space networks and promotion of safe NMT conditions, as well as expansion of the bicycle programme, Shova Kalula, were detailed in the PTAP (DoT RSA, 2007).

### 3.1.3 Overview of the Existing Local PT System

The existing PT system of the EM consists of on-road and railway modes, namely:

- Passenger Rail Agency of South Africa (PRASA);
- Bus services;
- Long-distance services;
- Metered-taxi operations; and
- Non-motorised transport (NMT) Facilities.

For the purpose of this study long-distance and metered-taxi operations will not be considered.

The KZN DoT PT vision is (ETA, 2005): *“To improve the quality of life of PT users and to enhance the viability of all sectors reliant on PT within KwaZulu-Natal, through the development of a safe, efficient, effective, economically and environmentally sustainable PT system which drives the economic and social upliftment of the Province”*. Within the EMA, ETA’s mission is: *“To provide and manage a world-class transport system with a PT focus, providing high levels of mobility and accessibility for the movement of people and goods in a safe, sustainable and affordable manner”* (ETA, 2005).

Isipingo (to the south), Durban CBD, Bridge City (to the north) and Pinetown (to the west) have been identified as major PT nodes (ETA, 2005), as indicated by Figure 3-4.

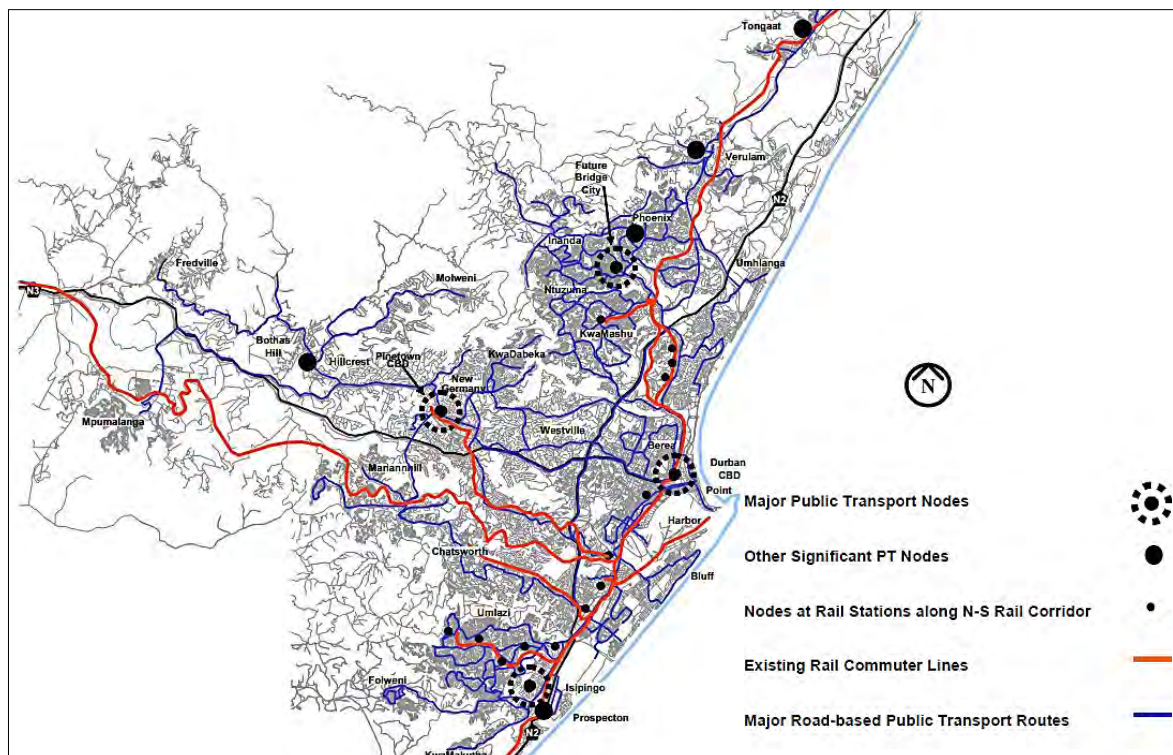

**Figure 3-4: Existing PT Services and Nodes (ETA, 2005)**

An estimated 40% of the EMA population utilises available PT services in the following order: minibus-taxi (68%), bus (25%) and rail (7%) (EM, 2014/2015). The National Household Travel Survey (2003) indicated that existing PT users are dissatisfied with the quality of the PT service. Results showed that for rail, minibus-taxi and bus services: 71%, 55% and 54% of users are frustrated with the level of crowding and 53%, 64% and 74% of users are unhappy with facilities at stops, ranks and stations, respectively (DoT RSA, 2007).

### 3.1.3.1 Passenger Rail Agency of South Africa (PRASA)

The South African Rail Commuter Corporation (SARCC) was transformed into PRASA in 2004, for the provision of improved mobility and accessibility for all. The primary objective of PRASA is: “to ensure that, at the request of the DoT, rail commuter services are provided within, to and from the Republic of South Africa in the interest of the public”. PRASA is responsible for the operation and maintenance of local trains for Metrorail and Shosholoza Meyl, under the PRASA Rail Division (PRASA, 2010). Metrorail operates at 317 stations in KZN, Gauteng, Cape Town and Eastern Cape; transporting over 2.2 M passengers annually. The operational Metrorail network in the EMA is shown in Figure 3-5.

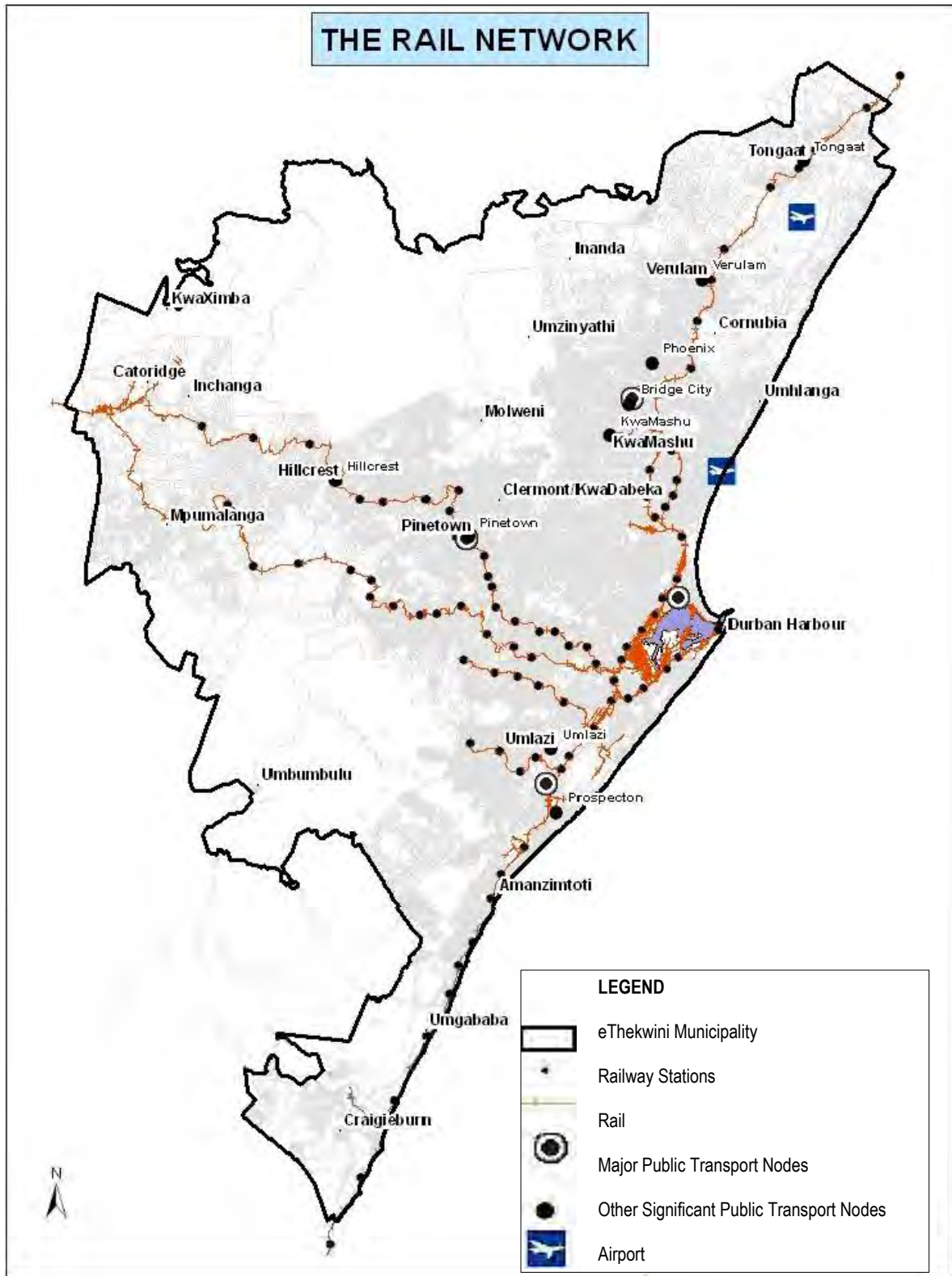

Figure 3-5: The Metrorail Network in eThekweni Municipality (EM, 2014b)



### 3.1.3.1.1 Existing Routes

The passenger rail system within the EMA extends along the North-South line from Stanger to Kelso, along the coast, with lines to Umlazi, Pinetown, Chatsworth and the Bluff. Inland rail services extend to Cato Ridge, as displayed in Figure 3-6, with the routes of Metrorail services.

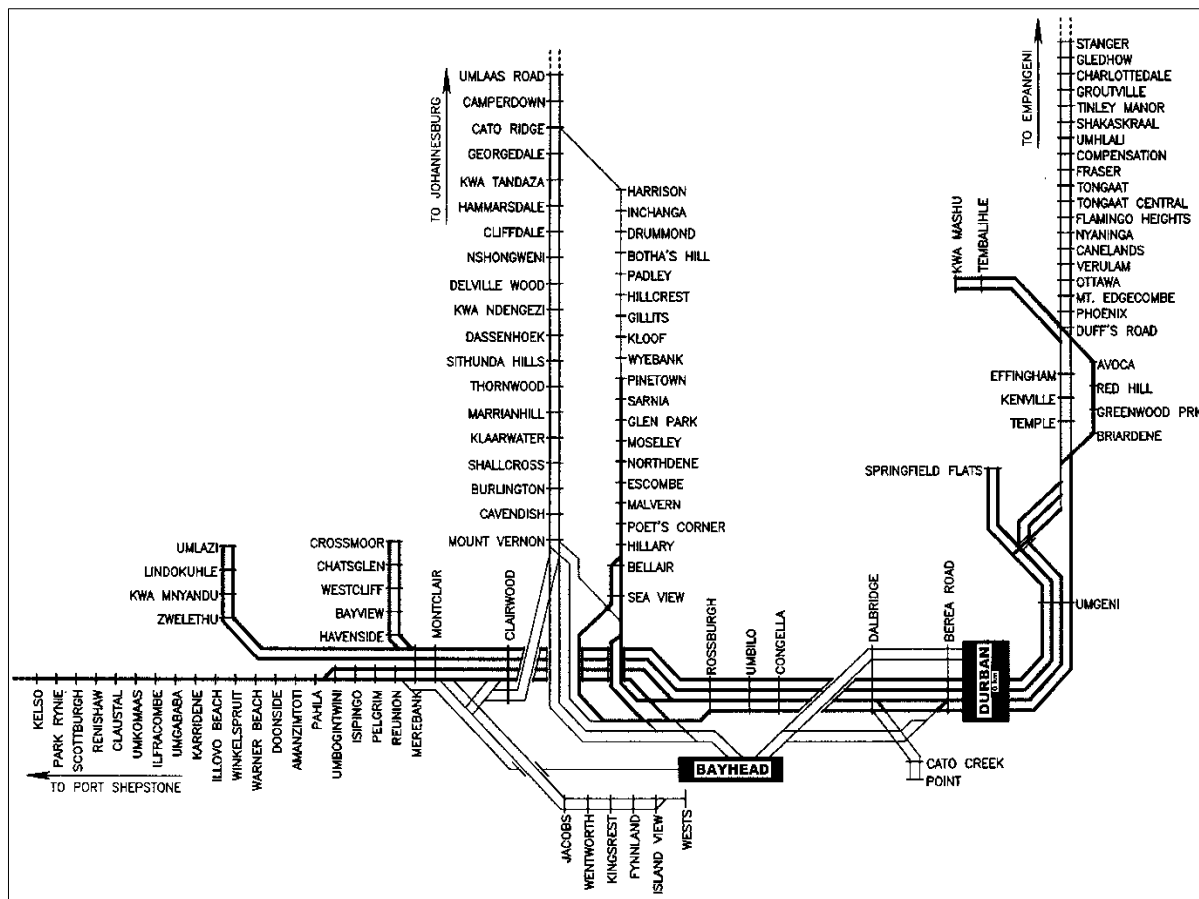

Figure 3-6: Metrorail Routes (Bhotha, 2013)

The total Metrorail system comprises 2 543 km of railway track encompassed by 55 rail routes (ETA, 2005).

### 3.1.3.1.2 Rail Fleet

The 5M2A red, burgundy and grey 'all steel suburban' trains arrived at the Durban Harbour in 1958 (PRASA, 2007). According to Luthuli (2013), these trains make up the existing rail

fleet and are still in operation, 50 years later. The trains, as shown in Figure 3-7, have been refurbished and technology updated to increase the useful life of the aging fleet (PRASA, 2007).



**Figure 3-7: Metrorail Train (PRASA, 2007)**

### *3.1.3.2 Bus Services*

Buses services within the EMA are provided by almost 200 operators, belonging to 13 associations. There are 1 600 single-direction bus routes serviced by almost 1 500 buses operated by subsidised (by the municipality) and unsubsidized entities. Durban Transport operates subsidised bus contracts on more than 50% of routes and accounts for more than a third of the total operational bus fleet (ETA, 2005).

#### *3.1.3.2.1 Subsidised Services*

The provision of subsidised bus services has preserved land use patterns (DoT RSA, 2007). Subsidised services within the EMA include: Durban Transport, People Mover and Mynah.

Durban Transport, run by Tansnat has a fleet of 451 buses, consisting of: Volvo, Daimler, Scania, MAN and DAF models (Wilkinson, 2013). Figure 3-8 shows the latest addition to the bus fleet of 44 new Scania buses in 2012.



**Figure 3-8: Addition of 24 New Scania Buses to subsidised fleet (Masikane and Mkhize, 2012)**

The People Mover aims to provide alternate services focused on Durban CBD distribution. It ensures improved high quality services that are safe and comfortable, whilst providing an ease of movement connecting tourists to Durban CBD and activity hubs. Operational from 05h00 to 22h00, the routes extend along the beachfront to Suncoast Casino; as a link from KE Masinga, Durban Railway Station and Victoria Street Market; and a line from Mahatma Gandhi Road to Greyville Racecourse. The 35-seater air-conditioned People Mover buses, shown in Figure 3-9, contain monitored surveillance, and are wheelchair friendly (ETA, 2005).



**Figure 3-9: People Mover Bus (Schilz, 2013)**

---

The Mynah Bus service runs between Durban CBD and Botanic Gardens, Morningside, Tollgate, Musgrave Road and Kensington. The ‘Muvo’ Smart Card, with extended expiration date on coupons, is an electronic payment method used across Durban Transport, People Mover and Mynah services. Launched in July 2012, the full roll-out of the Muvo Card has been completed and 86 000 Muvo Cards issued (ETA, 2012a).

The Sukuma bus, which contains automated wheelchair lift and six wheelchair places, operates between Durban CBD and Pinetown and Clermont, Merewent and Umlazi, and Ntuzuma (EM, 2014/2015).

### 3.1.3.3 Minibus-Taxi Industry

As defined by the NLTA of 2009, a minibus-taxi-type service is: “*an unscheduled PT service operated on a specific route or routes, or where applicable, within a particular area, by means of a motor car, minibus or midibus*” (RSA, 2009).

Within the EMA, the minibus-taxi industry, consisting of 120 taxi associations, services more than 1700 routes (ETA, 2005). SANTACO was formed in 2001 by DoT to enable better communication with the taxi industry through one forum (Walters, 2013). The minibus-taxi industry mainly operated Toyota Siyaya models, which predate Euro Standards, shown in Figure 3-10.



**Figure 3-10: Toyota Siyaya**

Due to the failure to formalise the minibus-taxi industry, the TRP was implemented to forcefully encourage the replacement of existing 16-seater minibuses with new, larger 18-35 seater vehicles. An incentive of R55 000, 00 was given to participating owners as a scrapping allowance (Venter, 2013). A list of vehicles compliant with the TRP is included in Appendix A. Although the TRP aimed to introduce larger vehicles with capacity of more than 16 (midibuses), many with a capacity of 14 have been accepted and comply.

### **3.1.4 Challenges in the Local PT Sector**

Overall, the PT system is ineffective and lacks structure. Many services are in competition with each other, resulting in inefficient and unprofitable trips (EM, 2014a). The ratio of PT/POV in the EM was 52:48 (ETA, 2005), however, private vehicle sales are anticipated to increase by 7.5% annually (Kruger, 2012), further reducing PT ridership.

The following obstacles are faced by the PT sector:

- Insufficient services and inadequate capital for upgrades;
- Lack of control (or enforcement) over transport modes, which gives rise to illegal and poor driving practices and duplicate services (Walters, 2013);
- Limited ability to provide safety at public pick-up and drop-off zones;
- Lack of integration of services between modes, resulting in inconvenient and expensive travel (EM, 2014a); and
- Detrimental environmental impact such as air and noise pollution, extreme land reserve required for road lanes (ETA, 2005).

The following problems exist in each vehicle category:

- Passenger rail:
  - Decreasing service levels;
  - Deteriorated rolling stock may lead to shut down of the system;
  - Low ridership suggests economic inefficiency of certain lines; and
  - Cable thefts and electricity cuts delay trains and services (ETA, 2005).
- Bus services:
  - Reducing quality of service and increasing subsidies;
  - Limited accessibility and low ridership during peak periods; and

- 
- Low profit margins of unsubsidized services do not enable fleet upgrades (DoT RSA, 2007).
  - Minibus-taxi industry:
    - Operates in direct competition with bus and rail services, reducing profitability of subsidised services;
    - Deteriorating fleet affect air quality, safety and reliability as breakdowns occur often (DoT RSA, 2007);
    - Excessive vehicles in operation due to lack of enforcement;
    - Overcrowding at inadequate facilities and informal stops;
    - Competition for 'route ownership' leads to violent confrontation; and
    - Unsafe driving practices (high speeds and overloaded vehicles) and high occurrence of road accidents (Walters, 2013).

Therefore, a restructure of PT services and new, modern IRPTN was needed and *GO!Durban*, was planned for the city of Durban in the EMA, as stipulated by the PTAP (DoT RSA, 2007).

### **3.2 *GO!Durban***

In effort to provide a safe and accessible PT network, the evolutionary *GO!Durban* system will replace the existing formal and informal PT available services. This section will detail the components of *GO!Durban*, to be implemented in the EMA, including an overview of the network, anticipated timeframes, infrastructure and possible vehicle selections.

#### **3.2.1 Objectives of *GO!Durban***

*GO!Durban*, the IRPTN planned for the EMA is centred around eight core provisional areas, namely: infrastructure, operational plans, intelligent transport systems (ITS) and integrated fare management systems (IFMS), skills development and sustainability, integrated corridor expansion, PT evolution and negotiations, marketing communications and transformation management, and municipal PT regulation (ETA, 2012a). The objectives of the 'wall-to-wall' IRPTN system include (EM, 2014b):

- Equal accessibility for all South Africans (including those with disabilities) in and around EM;

- Decrease in motorized transport emissions and environmental impact;
- Development of a liveable city (by reduction in congestion and accommodation of non-motorised transport);
- Positive effect on the economy in implementation and operational phases;
- Provision of quality services for PT users and a means of attracting private vehicle owners towards a modal shift; and
- Address of historical spatial structure by mixed land-use transportation.

According to the DoT, the goal for the PTAP (2007-2020) is “for metropolitan cities to achieve a mode shift of 20% of car work trips to PT networks”, however, this is improbable with the current PT system. *GO!Durban* aims to achieve this goal by 2030. *GO!Durban* (2030) will increase accessibility to scheduled PT services in the EMA by approximately 35%, in comparison to the existing system (2010). The full network will be within a 10-15 minute walking distance (800m) for more than 85% of the eThekweni region (EM, 2014b).

### 3.2.2 Overview of the Network

Figure 3-11 shows the routes of *GO!Durban*, which make up the nine corridors of the system.

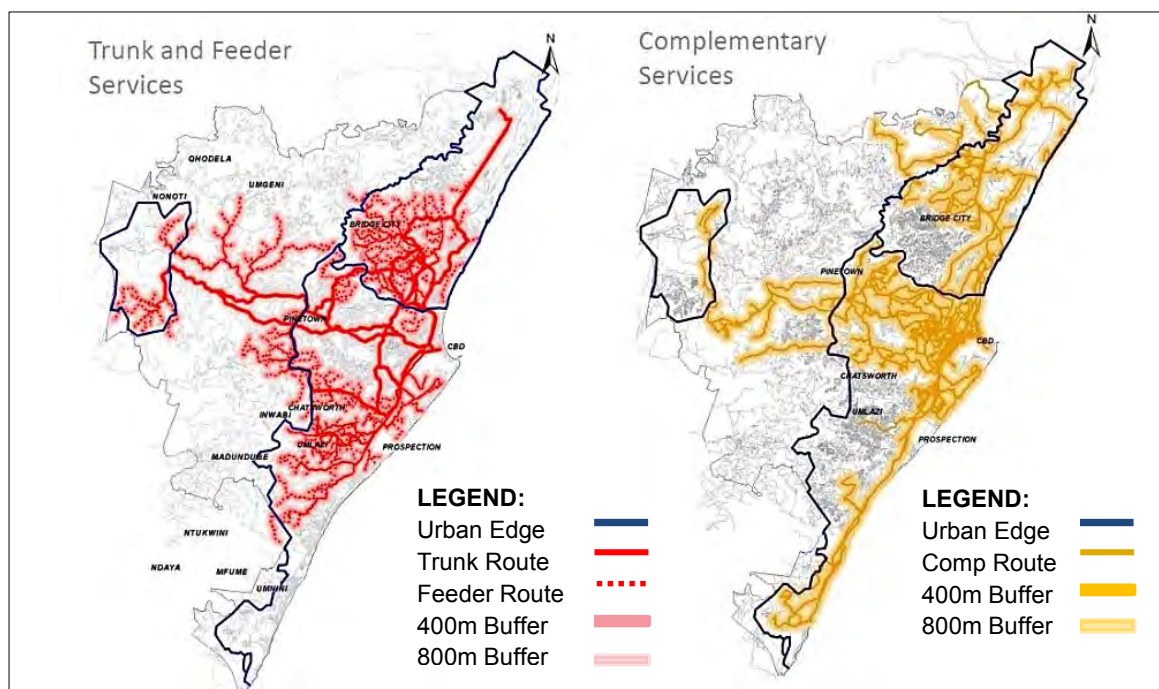

Figure 3-11: Overview of Trunk, Feeder and Complementary Routes (Barker, 2011)

---

The RRT and eight ROW BRT trunk routes are supported by feeder services and park and ride zones. The trunk routes will total 250km in length, including 60km of rail networks. A Complementary Quality Bus service will accommodate demand not sufficiently catered for by the trunk and feeder system (EM, 2014b). An urban boundary indicating the outline of developed areas is shown as an indication of services and accessibility to the urban zones in the EMA. A 400m and 800m accessibility buffer for all routes has been included. NMT facilities, depots, control centres and transfer stations are vital elements of the system.

### 3.2.3 Trunk Routes

The nine IRPTN corridors, as shown in Figure 3-12, to be implemented are (EM, 2014b):

- C1: Bridge City to CBD via KwaMashu;
- C2: Bridge City and KwaMashu via Berea Road to Umlazi and Isipingo;
- C3: Bridge City to Pinetown and New Germany;
- C4: Bridge City to Mobeni and Rosburgh via National Road 2 (N2);
- C5: Chatsworth to Durban CBD;
- C6: Hammarsdale and Pinetown to Durban CBD (with access to Mpumalanga by feeder services);
- C7: Hillcrest to Chatsworth;
- C8: Tongaat and King Shaka International Airport to Umhlanga and Durban CBD;  
and
- C9: Bridge City to Umhlanga New Town Centre via Cornubia and Phoenix Highway.

The corridors of *GO!Durban* will interlink at transfer stations to enable access to all areas. Seven Transfer Stations are shown in Figure 3-12 at residential and employment nodes:

- Bridge City (C1-C4, C9);
- Umhlanga (C8, C9);
- Pinetown (C3, C6 and C7);
- Durban CBD (C1, C2, C5, C6, C8); and
- Rosburgh and Prospecton (C2, C4, C5).



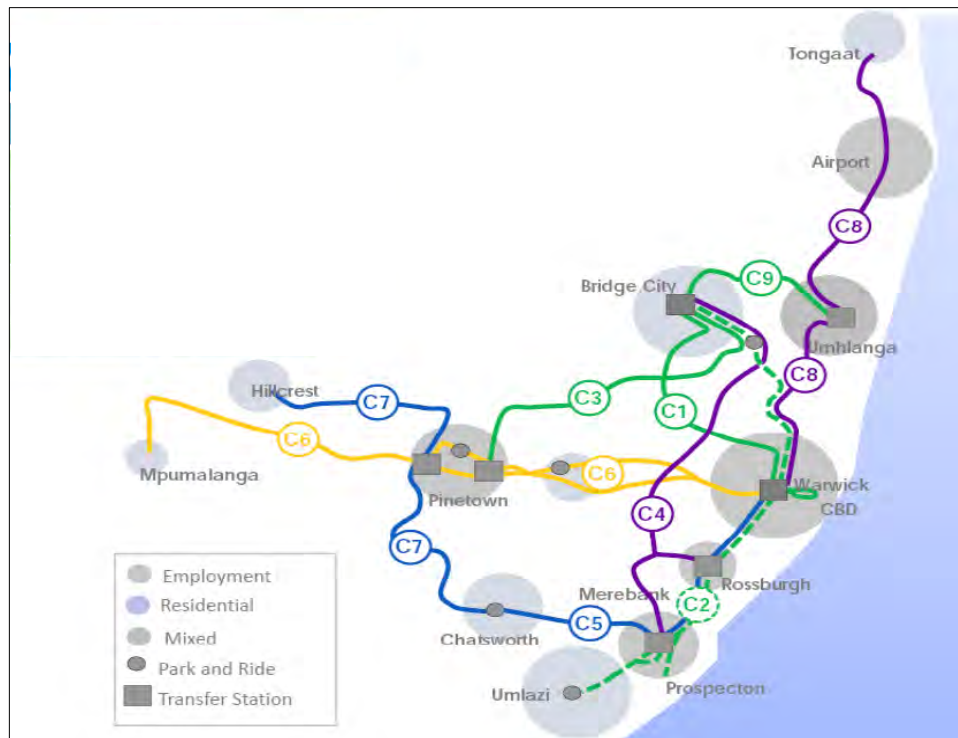

**Figure 3-12: Trunk Routes of the nine corridors of *GO!Durban* (EM, 2014b)**

To encourage usage of the network, park and ride zones have been designed at residential zones: Westville, Chatsworth, Umhlanga, Pinetown and Umlazi.

### 3.2.4 Phases of Implementation

The corridors of *GO!Durban* are to be implemented in phases according to anticipated timeframes shown in Table 3-1.

**Table 3-1: Anticipated operational year of *GO!Durban* Phases (EM, 2014b)**

Phasing		Planned Operational Year
Phase 1	C3	2016
	C1	2017
	C9	2018
	C2 (Rail)	2016
Phase 2	C5, C7	2022
Phase 3	C4, C8	2025
Phase 4	C6	2027

---

Evidence of the leapfrog approach is shown, as entire corridors will be implemented consecutively, starting in 2016 and ending in 2027. Phase One, consisting of three BRT routes and a rail corridor connecting Bridge City to other areas, enables mobility between Bridge City and surrounding areas. It is evident that the demand and urgency of services has motivated these routes and the decision to introduce them as Phase One (EM, 2014b). A memorandum of agreement between the leaders of the taxi industry (KZN Taxi Alliance and the South African Taxi Workers Organisation) and the EM was signed in support of the *GO!Durban* system. Since the implementation of the MUVO Card system, the discontinuation of the previous bus coupons used has followed. The terminal station at Bridge City has been constructed and the construction of the ROW bus lane for the first corridor to be implemented, C3, from Bridge City to Pinetown has begun (EM, 2015a). Only once all corridors of Phase One are implemented, will the introduction of complementary routes begin, therefore the incremental approach has been adopted for this set of routes. According to Chetty (2013), the preliminary design of Phase Two will only begin once Phase One is implemented, and progress with each phase.

The rail corridor, which is to be modernised solely by PRASA, is expected to be completed by 2016. The BRT trunk and feeder routes of Phase One are anticipated by 2018, beginning with C3, a new route between Bridge City and Pinetown. There is currently no direct route from KwaMashu to Pinetown, therefore, the introduction of C3 requires the construction of new roads. This corridor will set the standard for the BRT and serve as an indication of the IRPTN (EM, 2014b).

### **3.2.5 Phase One of *GO!Durban***

Phase One will accommodate approximately 25% of BRT trunk route demand. C2 is the rail trunk route designed to carry 40% of total PT demand at operational phase, together with feeder routes. The network will operate for 16 to 24 hours a day, with peak and off-peak frequencies of 5-10 minutes and 10-30 minutes, respectively (EM, 2014b).

Phase 1 consists of 3 terminals: Bridge City, Bram Fischer and Umhlanga Ridge, positioned with consideration to land-use, such as in close proximity to the shopping centre for access. The Bridge City multi-level terminal station, designed to look like Figure 3-13, is situated to serve the demand of 5 corridors (C1-C4, C9). It consists of a mezzanine level of 100 minibus

taxi bays for the feeder service and basement level of 22 bus bays. Park and ride facilities are not recommended for Phase One (EM, 2014b).



**Figure 3-13: Visual Impression of the Bridge City Terminal (Barker, 2011)**

#### 3.2.5.1 BRT Corridors

In accordance with the definition and components of BRT which were visited in Chapter 2, the ROW selected for *GO!Durban* specifies a fully segregated lane in the middle of the road for optimum priority. When considering a reserved lane for the trunk BRT, additional required road reserve is a limiting factor (EM, 2015a). BRT trunk lanes will be separated from mixed-traffic by a concrete (New Jersey) barrier, similar to that used for *MyCiTi* BRT lanes. A lane width of 3.5m is required, however 3m can be provided where bypass lanes exist. Lane reductions may be necessary to achieve the specifications of the BRT trunk routes, including the reduction of on-street parking at Umgeni. The generalised cross-section of road reserve along BRT trunk routes is shown in Figure 3-14. Since feeder and complementary routes will be along mixed-traffic lanes no additional infrastructure changes are required for these routes (EM, 2015b).

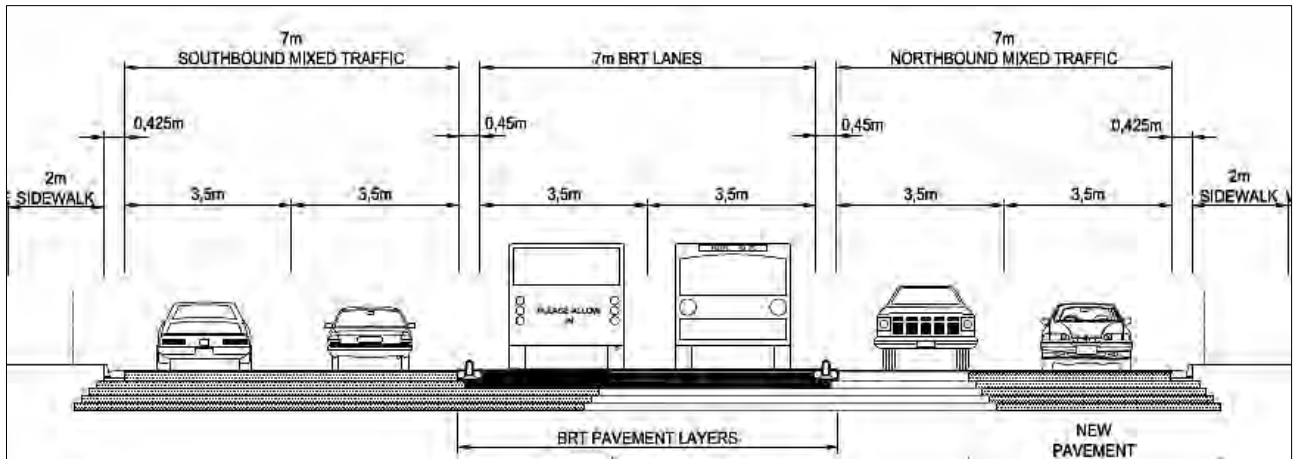

**Figure 3-14: General cross-section of BRT lanes for *GO!Durban* (GOBA Consulting et al., 2012a)**

Sheltered stations, as shown in Figure 3-15, will be positioned in the middle of the roadway to ensure easy boarding (EM, 2015a).



**Figure 3-15: Conceptual Design of BRT Station for *GO!Durban* (Barker, 2011)**

---

Articulate buses (for BRT trunk routes), and standard buses and midibuses are required for feeder and complementary routes. Possible selections for buses are those currently in usage along *Rea Vaya* and *MyCiTi* routes including: Scania 6x2/2 K310 and Scania 4x2 K270; and Volvo (Euro V) and Optare Solo SR, respectively.

### 3.2.5.2 PRASA Rail Corridor

An investment of R125 billion will be used for the modernization of the rail corridor, with intention of “*replacement and not refurbishment*” (EM, 2014b). The rail corridor will be an upgrade of the current rail system, including new trains. Although the existing metric gauge railway tracks will remain unchanged, the PRASA modernisation includes (EM, 2014b):

- New generation suburban rail fleet (rolling stock);
- New depots;
- Modern signalling and train control systems;
- Modern stations;
- Integrated ticketing system; and
- Signage.

The X'Trapolis Mega rolling stock, shown in Figure 3-16, has been selected for *GO!Durban* and is being built by Gibela Rail Transport Consortium (Gibela Product Engineering, 2014).



**Figure 3-16: PRASA New Generation Rolling Stock (Barker, 2013)**

A train set will comprise six air-conditioned coaches, with capacity exceeding 1200 passengers. Each coach contains six double doors for universal access and variations include toilets. Passengers will enjoy a quiet ride at speeds of 120 km/hr to 160km/hr, and have access to Wi-Fi internet access and luggage racks. The stainless steel structure is lighter than most trains and will consume less energy (Gibela Product Engineering, 2014). A 30% in reduction in electricity consumption, compared to PRASA's existing fleet, can be achieved through regenerative braking, during which energy from braking is used to power the trains. This means that in terms of GHG emissions less electricity generation is required and therefore, reduced emissions and environmental impact of rail services. (Gibela Product Engineering, 2014).

### 3.2.5.3 Non-Motorised Transport Facilities

NMT is a significant component of *GO!Durban*. Bicycle lanes and walkways, such as those in Figure 3-17, will provide safe facilities and increase NMT, particularly along mode changes.



**Figure 3-17: NMT components of *GO!Durban* (EM, 2014b)**

### 3.3 Summary

The inefficient and inadequate PT services provided in the EMA have resulted in the uncontrolled operation of the minibus-taxi industry. The operation of old, unreliable fleet has provided unsafe, expensive services and had a negative impact on vehicle emissions. The reliance on POVs and increasing demand for road space and maintenance costs are unsustainable, therefore, the PTAP has introduced IRPTNs in 12 cities in SA, including in the EMA.

IRPTNs provide high quality travel for high capacities along densified corridors. Overall, *GO!Durban* will introduce PT services that are accessible to 80% of eThekweni residents. Improved access to services will improve the quality of life of many South Africans. Reliable services with integrated fares will reduce travel costs and enable a more stable work force. ROW services will reduce travel time and trip lengths and attract a shift towards PT. A reduction in POVs and congestion on roads, in conjunction with advanced vehicle technology, will significantly reduce transportation emissions and improve air quality. Challenges in implementation and integration of existing services exist, however, commitment from government to enforcement, effective management and communication will ensure a successful system.

---

## CHAPTER 4

### METHODOLOGY

#### 4.1 Introduction

This chapter describes the methodology used to evaluate the carbon emissions of the study. As such it presents how data was gathered, how calculations have been done and the assumptions and related limitations. The methodology presented also includes approach evaluations, research boundaries, data collection, and data analysis.

#### 4.2 Approach Evaluation

Research relevant to the calculation of GHG emissions and appropriate methodologies were assessed in order to obtain an approach that would ensure all aims and objectives of the study were satisfied. A combination of both a theoretical and case study approach proved to be most effective.

##### 4.2.1 Theoretical Approach

Data collection using international and local sources of information, provided a greater knowledge on the subject matter of GHG emissions and methods of analysis, with attention to the transport sector and PT modeled data. General concepts including global warming, the greenhouse effect and responsible GHG were reviewed. The GHG emission from transportation, as well as different transportation modes were presented. The history the PT sector and national policy introduced were investigated to gain an understanding of the existing PT system, specifically why it functions the way it does, its shortcomings, and the requirement for a PT intervention. A broad concept of the IRPTN was established and systems around the world were studied. The IRPTNs introduced within SA (*Rea Vaya*, *MyCiTi*, *Libhongolethu*, and *RRT*) were investigated, more specifically the BRT system, with attention to success and problems incurred. Different vehicle technologies and their GHGs were critically evaluated.

This data was presented in the form of a literature review (Chapter 2). The case study (Chapter 3) detailed PT in the EMA to establish the context in which the study was



undertaken. Critical assessment and analysis of data was carried out and a series of sources were used. These included books, reports, journal articles, conference proceedings and reliable internet sources.

#### **4.2.2 Case Study Approach**

This approach was relevant to and applicable in a South African context. An attempt was made to produce an outcome with a valid representation of a GHG emission evaluation of the PT sector. The study was specific to the PT sector within the EMA according to the implementation of the PTAP of 2007 (as included in the Literature Review in Section 2.5). In addition, a mode shift of 20% of car work trips to PT modes is to be achieved by the target year of 2025. The shift to *GO!Durban* is detailed in the case study in Chapter 3.

This approach achieves an accurate CO<sub>2</sub>e emission comparison of the existing PT sector and the proposed wall-to-wall IRPTN. It involved the use of a software programme namely, *INRO EMME/2* which is used by ETA to model traffic based on different scenarios and projections. Necessary data on projected population travel patterns was extracted from *INRO EMME/2*. A model was developed to calculate the emissions of the existing PT system and the *GO!Durban* system with primary data extracted from *INRO EMME/2* and required emission factors, assumptions and fuel consumption applied. These results were used to evaluate the ability of *GO!Durban* to reduce emissions as compared to the current PT system, whilst providing a formal PT system. For the purpose of this study, two PT sector scenarios were considered for comparison, namely:

- Projections of the Existing PT System; and
- Projections of *GO!Durban*.

##### *4.2.2.1 Business-As-Usual (BAU) Scenario*

Comprehensive analyses of the current system (consisting of the entire functional fleet; both railway and on-road transportation) according to a Business-As-Usual (BAU) Scenario involved projections from the 2008 Household Travel Survey to 2030. Three cases considering technological improvements for fuel consumption were investigated under the BAU Scenario, namely:

- Option 1 – No improvements (refurbishment of existing fleet);

- 
- Option 2 – Annual technology improvement factors; and
  - Option 3 – Introduction of latest vehicle technology.

Additional data on electricity consumption was required for the rail component, and fuel consumption for buses and minibus-taxis, to calculate the total energy usage.

#### 4.2.2.2 *GO!Durban Scenario*

The preliminary plans and latest available information on *GO!Durban*, were used for this study. Considering that only one scenario can be modeled at a time in *INRO EMME/2*, the ‘wall-to-wall’ IRPTN was modeled. The following vehicle technology assumptions have been made concerning each emission projection of *GO!Durban*:

- Option 1 – Same vehicle technology used throughout (all phases of) *GO!Durban*;
- Option 2 – Annual technology improvement factor from 2015; and
- Option 3 – Latest available vehicle technology introduced in 2030.

For a phased approach, in the event of both systems running simultaneously, ArcGIS aided in the separation of *GO!Durban* into phases to create an ‘ideal’ phasing-out of existing PT system and phasing-in of the *GO!Durban Scenario*. The current PT record (CPTR) routes that were to be converted into *GO!Durban routes* were identified and discontinued as each phase of *GO!Durban* was implemented. In terms of phasing from a route perspective, this was acceptable. However, the two scenarios were modeled independently with different assumptions regarding integration with other vehicles on the road. Therefore, combining two scenarios will not accurately represent traffic patterns and the concurrent operation of systems could not be defined. Although NMT is a significant component of *GO!Durban*, the impact of NMT facilities on this study cannot be quantified in terms of GHG reductions.

*CDM AM0031 Large-scale Methodology: Bus rapid transit projects Version 05.0.0* and *Tool to calculate baseline project and or leakage emissions from electricity consumption* assisted in the calculation of projected CO<sub>2</sub>e emissions. AM 0031 is an international methodology developed by the CDM organization and used for the quantification of emission reduction projects. The carbon study conducted on *Rea Vaya* was done according to AM0031 analysed the ability of BRT systems to reduce GHG emissions of the PT sector, and served as a guideline within a South African context (Grütter, 2011). This research was guided by

---

the CDM AM0031 methodology and the results were compared to the results and conclusions of the carbon credits study on *Rea Vaya*.

### 4.3 Scope of study

This study served as an evaluation of the operational emissions of the PT fleet within the EMA, defined as the total CO<sub>2</sub>e emissions produced. It was an assessment of vehicular emissions of the BAU Scenario of the current PT system in comparison to the projections of the entire *GO!Durban*. The following components were beyond the scope of this study:

- Embodied emissions (from the production of vehicles or fuel, from raw material acquirement to manufacturing processes);
- Emissions from transportation of vehicle fleet (or imported vehicles parts to the EMA);
- Emissions due to construction (earthworks and machinery) and implementation processes of *GO!Durban*, including additional lanes or lane widening required; and
- Operational energy requirements for facilities of the PT system (such as depots, control centres, terminal stations, etc.) and emissions thereof.

Majority of the existing PT fleet comprises:

- The passenger-rail system run by Metrorail (under PRASA);
- Minibus-taxis:
  - Toyota HiAce (Siyaya); and
  - Toyota Quantum (and Sesfikile).
- Buses (those subsidised by the municipality have been used as a representation of the bus sector):
  - Scania;
  - Daimler;
  - Volvo;
  - DAF (Van Doorne's Aanhangwagen Fabriek); and
  - MAN (Maschinenfabrik Augsburg-Nürnberg).

On-road vehicles for *GO!Durban* have not yet been selected, however, a Euro Emission Standard IV requirement has been specified (Chetty, 2013). Therefore, vehicles used by

---

existing BRTs (*Rea Vaya* and *MyCiTi*) in SA have been selected as possible choices for the purpose of this study. The *X'Trapolis Mega* is the new rolling stock to be manufactured specifically for the rail corridor of *GO!Durban* (Gibela Product Engineering, 2014) and emission data was collected for these new trains.

#### 4.4 Data Collection

Data acquisition from several sources in the EM enabled an accurate assessment of passenger transport. The following sources were used:

- Existing PT system:
  - City Fleet – subsidised bus fleet and associated fuel consumption operated by Durban Transport;
  - Metrorail – rail fleet, electricity consumption and annual patronage;
  - eThekweni Energy Department – GHG Inventory 2013; and
  - ETA – *INRO EMME/2* traffic projections of PT in the EM.
  
- *GO!Durban*:
  - ETA – Preliminary IRPTN Plans and *INRO EMME/2* traffic modeling;
  - Gibela – *X'Trapolis Mega* profile and energy consumption;
  - City of Cape Town – *MyCiTi* route vehicles and diesel consumption;
  - Piotrans (*Rea Vaya* Operator) – vehicles and fuel consumption; and
  - *Rea Vaya* – Carbon Credits Monitoring.

##### 4.4.1 *INRO EMME/2* Transportation Forecasting Software

Emme is a travel demand modeling programme for macroscopic studies (national, regional and urban areas). Based on the four step model – Trip generation, distribution, assignment and modal choice – Emme 4 applications include:

- Travel demand forecasting;
- Transit planning (e.g. IRPTNs);
- Traffic planning (evaluation of network expansion); and
- Economic, emission and environmental analysis (INRO, 2013).

A study conducted on *TransJakarta* utilised EMME/2 software (Alvinsyah and Zulkati, 2005). A supply-demand model was generated based on the four step model to assess the impact of the BRT on the existing services in operation along the corridor. Supply focused on the transport network available and the demand model on transport demand, according to input factors (data on age, gender, economic status, family structure, number of vehicles owned, origin and destination points, travel times and modes used) as shown in Figure 4-1.

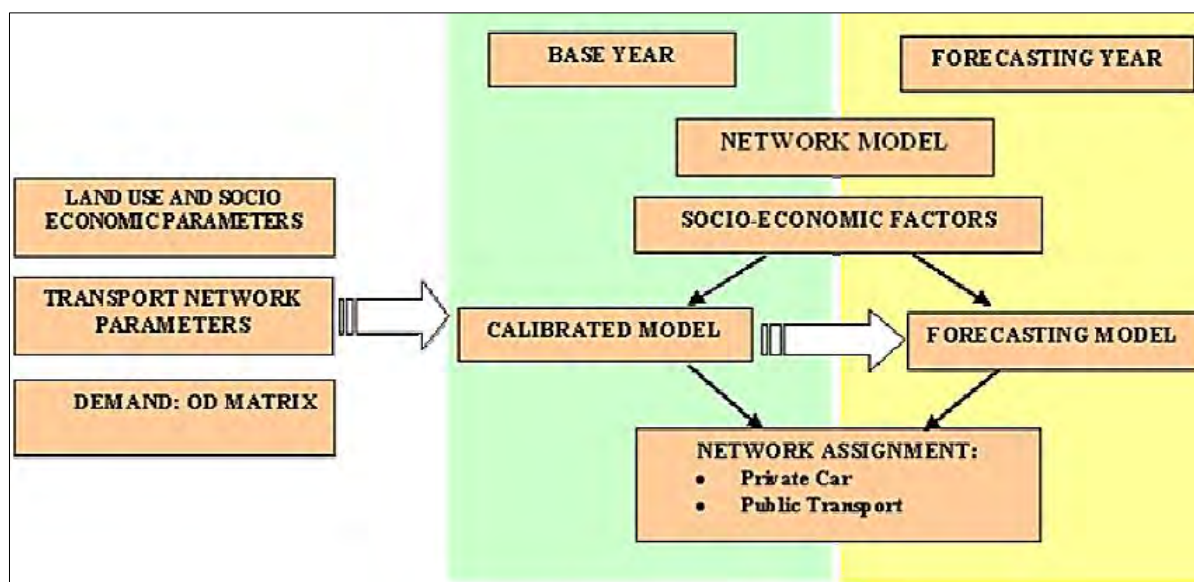

**Figure 4-1: Research Framework for Emme (Alvinsyah and Zulkati, 2005)**

Geometric data was used to develop a transport network model, and services along routes, the PT model. In contrast to the existing system which operates in mixed traffic, the BRT system operates on designed BRT corridors. Validation of the existing and BRT model is required before forecasting is conducted. Comparison of the predicted peak hour passenger usage and observed trips demonstrates an 8% difference between the Emme model and actual ridership. Within a margin of 10% error, this model is accepted for simulation (Alvinsyah and Zulkati, 2005).

In a similar manner, this software was used in the EMA by the ETA. Scenarios are projected onto the 2008 base-year model, which is built on origin-destination (O-D) data from the 2008 Household Travel Survey (HTS) and CPTR of 2004. Efforts to update the CPTR were unsuccessful. The HTS, conducted between 2007 and 2008, comprised 60 areas as a fair representation of the 338 traffic zones in the EMA. The survey included age group,

employment, income group and car ownership, as well as all trips made by members of each household (trip purpose, origin and destination, time of departure and mode of transportation used). *EMME/2* utilises a (60x60) matrix containing the HTS 2008 data, including expected population growths and spatial development, as well as vehicle O-D data (routes and frequencies) and passengers boarding from CPTR 2004. Population growth rates increase towards 2020 and are projected to decrease after 2035. The progression of AIDS in the EMA is a contributing factor of the growth rate (Moodley et al., 2011).

Daily traffic volumes consist of: the morning (AM) peak, the afternoon (PM) peak and the remaining off-peak period. As advised by ETA (Moodley, 2013) the *EMME/2* forecasted outputs comprise the AM Peak Hour travel patterns; the maximum hour during the morning peak period, as these contain the daily maximum travel (combined work and school morning trips).

ETA provided necessary traffic data modeled on *EMME/2* according to two scenarios for the AM Peak Hour: Existing PT System and *GO!Durban*. The *EMME/2* AM Peak Hour Scenario outputs obtained include:

- 2008;
- 2015 projections;
- 2020 projections;
- 2025 projections; and
- 2030 projections.

The modeled data is based on population growths according to specified factors for three growth projections, namely:

- Low-population growth – existing modal split;
- Intermediate-population growth – with a 10% modal shift from POVs towards PT; and
- High-population growth – with a 20% modal shift towards PT as stipulated by the PTAP (DoT RSA, 2007) by year 2025.

---

For both the intermediate and high-population growth factors, a modal shift from POV usage towards PT is required to accommodate all passengers on the network due to road reserve capacities.

#### **4.4.2 Existing PT System**

The existing PT system within the EMA consisted of the:

- PRASA (Metrorail) passenger system;
- Bus system; and
- Minibus-taxi system.

In calculating the carbon emissions of the PT fleet, information on the vehicle models used, fuel usage and emitted GHGs were necessary.

##### *4.4.2.1 eThekweni Municipality Subsidised Bus Fleet*

Due to a limited access to information (from private companies), it was assumed that the entire bus fleet operational within the EMA was similar to the subsidised bus fleet. A list of all buses (see Appendix B) belonging to the EM Fleet which is operated by Durban Transport, as obtained directly from Mr. John Wilkinson at Lorne Street Depot. With his assistance, diesel consumption and total mileage for the month of June 2013 was provided. Fuel consumption data for the year of 2012 was available; however, record of vehicle mileages was discontinued for this period.

The respective chassis manufacturers were approached with the request of fuel consumption and emission studies conducted. Volvo, DAF and MAN assisted in providing data on the vehicles.

##### *4.4.2.2 Metrorail System*

Electricity for the direct operation of Metrorail traction substations was supplied by Eskom (Winkelspruit, Northdene, Umlazi, Reunion and Clanstal substations) and EM to metropolitan nodes (Durban CBD, Pinetown, Booth, Springfield) according to available land for pylon structures (Mbonambi, 2013). Monthly electricity consumption data for each substation in the EMA was provided by Metrorail for the year of 2012. The total length (km)

of each route, along with the revised hourly schedules (total number of coaches and trips made along each route per week) and applicable passenger capacities were obtained from Metrorail. The total Metrorail passenger stats were made available to the public in published PRASA annual reports.

Information from Metrorail (PRASA, 2007) indicated the useful life of rolling stock (33 years for undercarriages and 12 years for components), thereby confirming the new train sets required by the Passenger Rail Plan (DoT RSA, 2007) as existing rolling stock is more than 50 years old (Luthuli, 2013).

#### 4.4.2.3 Minibus-Taxi Industry

The TRP, as stipulated by the PTAP, requires the replacement of the old vehicles used by the minibus-taxi industry (DoT RSA, 2007), with vehicles compliant with the National Regulator for Compulsory Specifications (NRCS, 2014) (included in Appendix A) to provide transportation by roadworthy vehicles. For the purpose of this study, the Toyota Quantum/Ses'Fikile was assumed to be the leading replacement vehicle for the TRP. The progress of the TRP per province was obtained from the Scrapping Taxi Administrator (TSA) and the results for KZN are shown in Table 4-1. It was assumed that the EMA followed the same trend as KZN.

**Table 4-1: Progress of TRP in KwaZulu-Natal (TSA, 2009)**

<b>Year</b>	<b>Vehicles Scrapped</b>
<b>2006/7</b>	549
<b>2007/8</b>	1 010
<b>2008/9</b>	853
<b>2009/10</b>	550
<b>Total</b>	2 962

The TRP was terminated in 2011 due to the implementation plans of *GO!Durban* (Naidoo, 2014). This would normally not have an effect on the BAU Scenario; however, the completion of TRP cannot be accurately predicted beyond 2011. Within the BAU Scenario,



the introduction of new vehicles by the TRP brought about the most significant change to the PT fleet, reducing GHG emissions. This study considered the enforcement of the TRP to completion (according to existing PT policy), ensuring all non-roadworthy vehicles were removed from the roads of the EMA.

The number of operating minibus-taxis in the EMA, along with vehicle frequencies and average trip distances was obtained from the Energy Department (Naidoo, 2014).

#### **4.4.3 The *GO!Durban* System**

In calculating the projected GHG emissions of the IRPTN fleet, information on the proposed operating schedules, potential vehicle selection and specifications were required. These were obtained from ETA. Other South African IRPTNs were consulted with regard to possible vehicle selection, namely: *MyCiTi* and *Rea Vaya*. The PTAP (DoT RSA, 2007) and Long-Term Mitigation Scenarios (2007) were the basis for this scenario.

##### *4.4.3.1 eThekweni Transport Authority (ETA)*

Documents obtained from ETA contained:

- Preliminary Design Drawings;
- Technical Note TN-ROW-22: Feeder Route Analysis along with Appendices.
- GIS Shape Files for:
  - CPTR 2004; and
  - IRPTN (trunk, feeder, complementary) routes.

These were the latest revisions of documentation available at the time of this study.

##### *4.4.3.2 MyCiTi Bus Fleet*

Preliminary fuel consumption data for current and prospective fleet (including Volvo, Scania and Optare Solo models) for a limited operating sample for *MyCiTi* Phase1 trunk and feeder routes were obtained from the Transport and Information Centre (TIC) of Cape Town. The operating vehicles for *MyCiTi* include:

- 18m articulated Volvo B12MA chassis;
- 12m rigid Volvo B7R chassis; and

- 
- 9m Solo Optare SR.

#### 4.4.3.3 *Rea Vaya Bus Fleet*

*Piotrans Pty (Ltd)* is the private Bus Operating Company contracted for the operation of *Rea Vaya* buses for 12 years. *Piotrans* consists of 300 stakeholders which were previously minibus-taxi operators, incorporated into the Bus Operation of *Rea Vaya* (Piotrans, 2011). Under Scania advisory, bus specifications including actual recorded fuel consumption were obtained from *Piotrans*. The existing buses used for operation of *Rea Vaya* are:

- 18m Scania 6x2/2 K310; and
- 12m Scania 4x2 K270.

#### 4.4.3.4 *Rea Vaya Carbon Credits Study*

A carbon credits study assessing the environmental impact of the implementation of *Rea Vaya* Phase 1A and 1B was obtained from the Gauteng Transport Department – Scheduled Services Business Unit. Monitored gases included: CO<sub>2</sub>, CH<sub>4</sub> and N<sub>2</sub>O. This study served as a benchmark, in accordance with the *CDM AM0031 Large-scale Methodology*, and provided factors applicable in a South African context (Grütter, 2011).

### **4.4.4 List of Emission and Energy Consumption Factors**

Obtaining data directly from South African producers and manufacturers was extremely challenging, due to reservations about releasing information into the public domain and confidentiality agreements in the early planning phases of the system.

#### 4.4.4.1 *Fuel Consumption Factors*

For buses subsidised by the EMA where data was not provided by the manufacturer (Daimler and DAF), the general manager at City Fleet, indicated that the average diesel consumption for buses (containing air-conditioning) owned by the municipality is 55-60 L/100km (Ngwenya, 2013). The fuel consumption (energy requirement) for each PT vehicle and source of data for the existing PT system is shown in Table 4-2.

**Table 4-2: Fuel Consumption Factors and Sources for Existing PT System**

<b>Vehicle Category</b>	<b>Model</b>	<b>Euro Std</b>	<b>Fuel Type</b>	<b>Fuel Consumption</b>	<b>Source</b>
	A63 MAN 18232	II	Diesel	35-42 L/100km	
	HB2 MAN LION'S Explorer 2009	III		38-45 L/100km	Dias (2013)
<b>Bus</b>	A84 MAN 18-280 HOCL (People Mover)	III		45 – 50 L/ 100km (with air-conditioning)	
	Scania K230	III		51.9 L/ 100km	Cajiao (2013)
	Toyota HiAce (Siyaya)	0	Petrol	13.6 L/ 100km	IPCC (1996)
<b>Minibus-Taxi</b>	Toyota Quantum 2.7 Ses'fikile	II	Petrol	6.1 L/ 100km	McCarthy Toyota (2013)
	Toyota Quantum 2.5D-4D Ses'fikile	II	Diesel	7.3 L/ 100km	

Based on the obtained data, the average diesel consumption was calculated for entire bus fleet. As no published local emission factor for the Toyota HiAce (Siyaya) could be obtained, the IPCC factor of 13.6 L/100km (IPCC, 1996) as used in a South African study (Grütter, 2011) was considered appropriate. According to AM0031, if less than 10% of vehicles consume a different fuel type, all fuel can be assumed to be the 90% type. Therefore, the

Toyota Siyaya was assumed to be petrol and the Toyota Quantum/Ses'Fikile diesel, as this considered the worst case of emissions.

The fuel consumption or electricity usage for each potential vehicle for *GO!Durban* is shown in Table 4-3.

**Table 4-3: Fuel Consumption Factors and Sources for *GO!Durban***

<b>Vehicle Category</b>	<b>Model</b>	<b>Euro Std</b>	<b>Fuel Type</b>	<b>Fuel Consumption</b>	<b>Source</b>	
<b>Articulated Bus</b>	Scania 6x2/2 K310	IV		63.5 L/ 100km	Cajiao (2013)	
	Volvo 6x2 B12MA	V		61.3 L/ 100km	Mostert (2013)	
<b>Feeder / Complementary Bus</b>	Scania 4x2 K270	IV		51.9 L/ 100km	Cajiao (2013)	
	Volvo B7R 8700 LE	V	Diesel	40.8 L/ 100km	Mostert (2013)	
<b>Feeder / Complementary Minibus</b>	Toyota Quantum/Ses'fikile	II		7.3 L/ 100km	McCarthy Toyota (2013)	
	Mercedes Benz Sprinter	V		12.6 L/ 100km	Mercedes Benz (2014)	
<b>Rail</b>	X'Trapolis Mega	3V DC	-	Elec- tricity	15.56 kWh/ km	Gibela Product Engineering (2014)
		25V AC			16.31 kWh/ km	

Due to the vehicle capacity of complementary buses being equal to that of feeder buses (60), as modelled in *EMME/2*, the same vehicle was selected for both routes. This may not

be the case, as smaller buses may be required along complementary routes, however, a conservative approach was adopted for the purpose of this study.

Considering the level of information available for *GO!Durban* and changeability of the system in planning stages, vehicle selection presents the highest level of uncertainty. The factors for transport, however, have been classified as accurate in a South African context.

#### 4.4.4.2 Emission Factors

Carbon emissions factors (in terms of GHG CO<sub>2</sub>e) were required to conduct an analysis on the operational emissions of *GO!Durban*. Emissions per fuel type were adopted from AM0031. The buses (DAF, Mercedes and MAN, and Scania and Volvo) were procured from European countries (namely Holland, Germany and Sweden, respectively), therefore, comply with Euro Emission Standards. Although driving technique and topographical features differ, the use of European emission factors was appropriate. All rail data, however, was obtained within SA from Metrorail and Gibela, as the electricity generation pertains to Eskom within SA. A list of sources and accuracy of emissions data in grams per litre is summarised in Table 4-4.

**Table 4-4: Default Emission Factors (in grams per litre) (CDM, 2011)**

Vehicle Category	Emission Factors		
	CO <sub>2</sub>	CH <sub>4</sub>	N <sub>2</sub> O
<b>Bus (diesel)</b>	2 661	2	21
<b>Minibus-Taxi (petrol)</b>	2 313	13	14
<b>Minibus-Taxi (diesel)</b>	2 661	1	51

While measurement according to vehicle compliance with international Euro Emission Standards (GHG emissions per km) only considers the vehicle technology, the AM0031 factors utilised in Table 4-4 allow for the estimation of emitted gases specific to vehicle usage (fuel consumption is accounted for along with driving technique and topography specific to South African usage) and fuel technology.

For the electricity generation required by the passenger rail component, Eskom has specified an emission factor of 0.96 kg CO<sub>2</sub>/kWh for 2011 to be improved to 0.68 kg

---

CO<sub>2</sub>/kWh in 2030 (Eskom Holdings Limited, 2011). This will ensure that the CF for electricity generation in 2030 is equivalent to that of 2011. These improvements are assumed to occur at a steady rate over the period, not instantaneously at a particular year. In 2006, distribution losses alone were 6% (Eskom Distribution, 2010). Therefore, transmission and distribution losses for the purpose of this study are estimated at 10% and applied to consumed electricity.

## 4.5 Data Analysis

To achieve the aims of this study, an Excel-based calculation model was generated by the author to process the obtained data for analysis. Emission factors were applied to validated PT forecasted data extracted from *EMME/2*.

Analysis was done according to:

- Conversion of *EMME/2* AM Peak Hour outputs to annual data; and
- CO<sub>2</sub>e comparison of the BAU and *GO!Durban* Scenarios.

### 4.5.1 Conversion of AM Peak Hour Data to Annual Outputs

The *EMME/2* AM Peak Hour modeled traffic data was inserted into the model, and the total passenger-kms, passenger-hours, vehicle trips and mileage of each vehicle mode for the base-year (2008) calculated.

In converting the AM Peak Hour outputs modeled by *EMME/2* to annual travel data, the following methods were considered:

- Proportions from results of 2008 eThekwini HTS; and
- Widely used factor of 10 over 365 days (DMA, 2008).

#### 4.5.1.1 eThekwini Household Travel Survey (HTS) 2008

This method made use of the HTS conducted in the EMA in 2008, seeing that the *EMME/2* 2008 base-year model was built on the results of the HTS. The PT passenger travel patterns produced by the survey are illustrated in Figure 4-2. The morning peak is clearly visible between 05h00 and 08h00, due to corresponding school and work starting-times; however,

the afternoon peak is spread out due to varying school and work ending-times. Therefore, the ridership of the AM Peak Hour is greater than the PM Peak Hour.

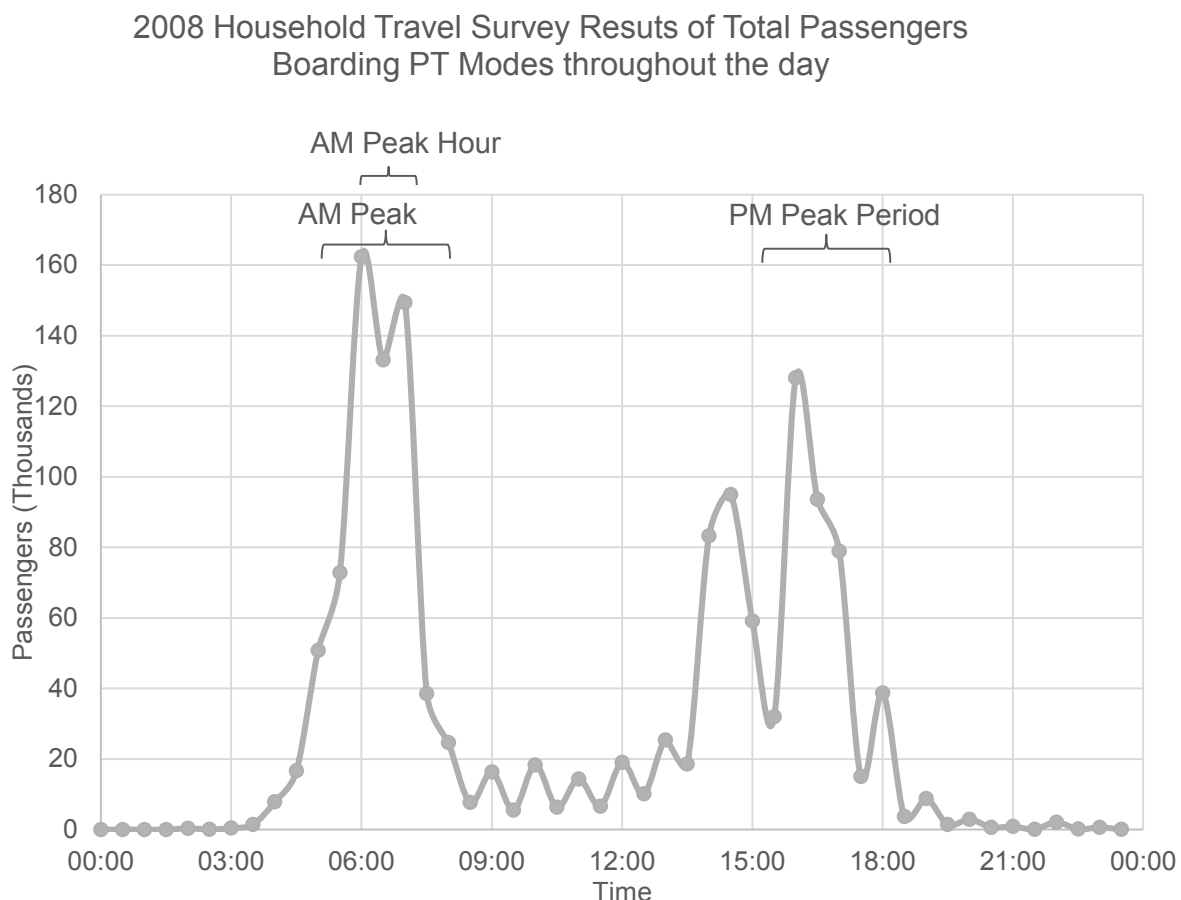

**Figure 4-2: PT Passenger Travel Trend results from HTS 2008**

The HTS 2008 showed that the AM Peak Hour comprises 49% of total passengers boarding in the total three-hour AM Peak Period (Moodley et al., 2009). 64% of the total passengers in the AM Peak Period board during the PM Peak Period. The Off-Peak Period comprises 76% of total passengers boarding in the AM Peak Period. Considering that the AM and PM Peak Periods only encompass six hours a day, the Off-Peak Period comprises the remaining 18 hours, producing in the higher portion of boarding passengers.

The addition of the AM Peak Period, PM Peak and Off-Peak Periods result in daily travel outputs. It is assumed (GOBA Consulting et al., 2012b) that travel volumes on weekdays (Monday to Friday) are double those on weekends (Saturdays and Sundays). The total daily

volumes are applied to 261 days (weekdays) and halved on 104 days (weekends), with no differentiation for Public Holidays.

#### 4.5.1.2 Factor of 10 over 365 days

This method is used by various worldwide studies, including (ETA, 2005). It involves multiplying the *EMME/2* outputs by a factor of 10 to convert from the AM Peak Hour to a daily output value. It is assumed that every day of the year (including weekends and Public Holidays) follow this daily pattern, therefore the daily output is multiplied by 365 days to obtain the annual output.

#### 4.5.1.3 Summary

The results of this study are majorly dependent on the *EMME/2* outputs and accurate conversion to annual data. The 'Factor of 10' (DMA, 2008) and HTS 2008 proportions are displayed in Figure 4-3, over a year.

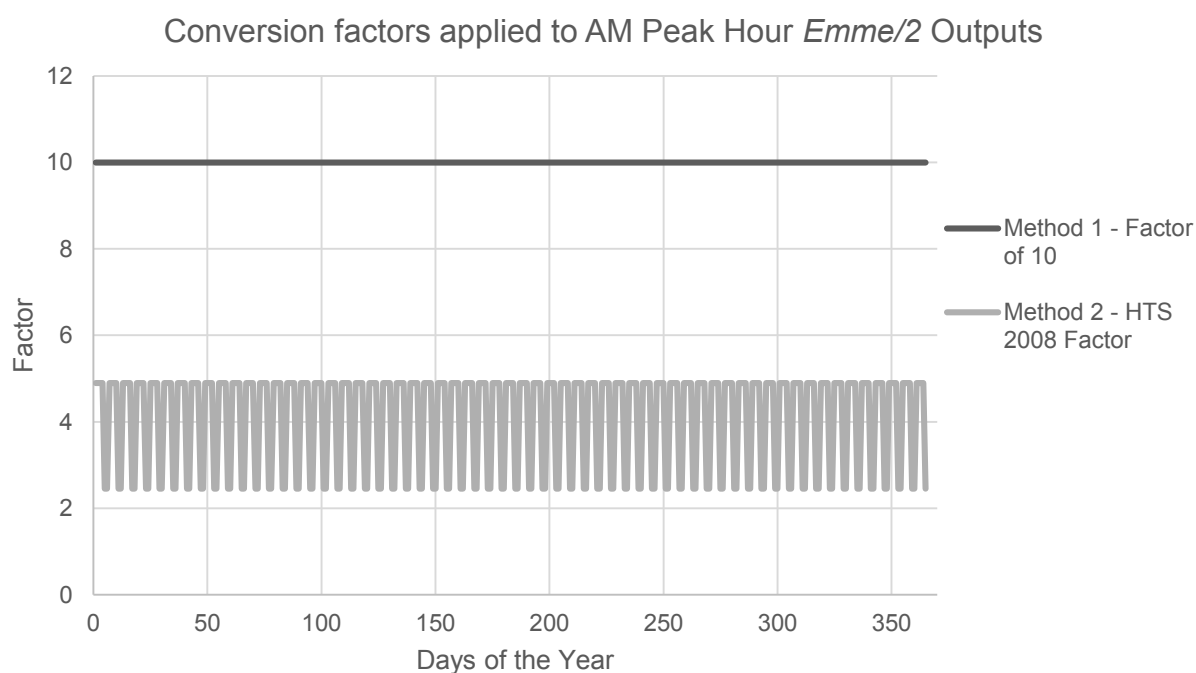

**Figure 4-3: Conversion Factors for Annual *EMME/2* Outputs**



---

It is evident that the 'Factor of 10 Method', although widely used, assumes a constant travel volume throughout the year. This is not an accurate representation of the PT travel patterns indicated by the HTS 2008, in which passenger travel varies throughout the week. Seeing that a difference of a factor of more than two exists, this will have a significant impact on the overall results. Although the application of a constant factor to both the BAU and *GO!Durban* Scenarios may be acceptable for a high level assessment, however, in an attempt to accurately satisfy the aims of this study (quantitative results) the most precise factors must be used for calculation purposes. Therefore, the usage of the HTS 2008 factors accurately reflects the PT travel behavior of the EM.

#### **4.5.2 CO<sub>2</sub>e Emissions Comparison**

For the calculation of CO<sub>2</sub>e emission for both scenarios for the three specified options, in accordance with AM0031, respective emission factors were applied to fuel consumption for corresponding vehicle fleets and appropriate factored distances from EMME/2 extractions. A sample calculation has been included in Appendix B.

##### *4.5.2.1 CO<sub>2</sub>e Emissions for the BAU Scenario*

The Business-As-Usual (BAU) Scenario was considered for the forecast of the existing PT system. It implies 'growth without constraints' and does not consider mitigation in the PT sector, besides fleet renewal and maintenance. This scenario was done with the assumption that no PT interventions occurred and only includes accelerated modal recovery of the PTAP (DoT RSA, 2007). This scenario investigates the occurrence of a shortage of funds to implement all three phases of the PTAP. Since all PT objectives of Phase One (2007-2010) were achieved in the EMA before the 2010 FIFA World Cup, the short-term goal was been met.

Passenger rail services, the bus system and minibus-taxi industry as sources of operational emissions were considered in the existing PT system (BAU Scenario). The BAU Scenario follows an extrapolated completion of the TRP. The termination in 2011 would not have occurred in the absence of *GO!Durban*, therefore, is not a true representation of the BAU occurrences and has been omitted. Assuming that the TRP continued in the EMA according to the scrapping rate of KZN (Taxi Scrapping Administrator, 2009), the programme would reach completion in 2022. Although operators were only given up to 2011 to comply with the

requirements, the success rate indicates a need for enforcement. Therefore, completion of the TRP in 2011 was neglected and the scrapping rate in KZN was applied (up to completion in 2022) to the projections.

Table 4-5 summarises the assumptions applied to the BAU Scenario.

**Table 4-5: Assumptions for each option of the BAU Scenario**

Vehicle Category	Option 1	Option 2	Option 3
	No technology improvements	Annual technology improvement factor	Latest technology improvements
<b>Passenger Rail</b>	Refurbishment of existing rolling stock	0.68 kg CO <sub>2</sub> /kWh in 2030 (Eskom Holdings, 2011)	X'Trapolis Mega Trains (replacement from 2017 to 2027)
<b>Bus</b>	Replacement of vehicles by Scania 4x2 (Euro III)	Application of the AM0031 0.99 annual technology improvement factor (CDM, 2011)	Replacement of vehicles by Volvo B7R (Euro V)
<b>Minibus-Taxi</b>	Replacement of vehicles by Toyota Quantum/Ses'Fikile (Euro II)		Replacement of vehicles by Mercedes Benz Sprinter (Euro V)

Vehicle replacement would be instantaneous, creating a staggered trend, with the useful life of 10 years for minibus-taxis and 12 years for buses (NH DoT, 2012), as applied to Option 1 and 3. An overall annual factor, however, due to unknown improvements is covered by Option 2.

#### 4.5.2.2 CO<sub>2e</sub> Emissions for the GO!Durban Scenario

GO!Durban consists of nine corridors comprising eight BRT trunk routes and a rail trunk corridor, serviced by a feeder routes and assisted by a complementary service, as detailed in Chapter 3.

All phases of *GO!Durban* were to be introduced by 2022, however, *GO!Durban* has released new completion dates (EM, 2014b). These show implementation of the final corridor and Phase Four in 2027. Therefore, for the purpose of this study, the wall-to-wall *GO!Durban* network can only be modelled according to the 2030 projection. The case study evaluates the total emissions of the entire network for the year of 2030, comprising CO<sub>2e</sub> emissions from the following vehicles:

- *X'Trapolis Mega* – Passenger Rail Corridor;
- Articulate Bus – Eight BRT Trunk Routes;
- Standard Bus – Feeder and Complementary Routes; and
- Minibus – Feeder and Complementary (Comp) Routes.

Table 4-6 summarises the assumptions made for emission calculations for the *GO!Durban* Scenario. Electricity emission factor to 0.68 kg CO<sub>2</sub>/kWh in 2030 (Eskom Holdings Limited, 2011).

**Table 4-6: Assumptions for each option of *GO!Durban***

<b>Vehicle Category</b>	<b>Option 1 Use of same vehicle model for all phases</b>	<b>Option 2 Technology improvement factor</b>	<b>Option 3 Latest technology in 2030 for all phases</b>
<b>BRT Trunk Routes</b>	Scania K310 6x2/2 (Euro IV)		Volvo B12MA (Euro IV)
<b>Feeder/ Comp Bus</b>	Scania K270 4x2 (Euro III)	Factor of 0.99 applied each year from implementation to 2030.	Volvo B7R (Euro IV)
<b>Feeder/ Comp Minibus</b>	Toyota Quantum/Ses'Fikile (Euro II)		Mercedes Benz Sprinter (Euro IV)

---

### 4.5.3 Sensitivity Analysis

The input parameters of the BAU and *GO!Durban* Scenarios were varied by 5% and 10% to investigate the overall influence on GHG emission reductions of the project. The following parameters were explored for bus, minibus-taxi and rail modes, and standard bus, articulate bus, rail and midibus vehicles:

- Fuel and electricity consumption rates;
- Projected distance driven (vehicle-kilometres); and
- Total travelled distances for each system.

### 4.5.4 Limitations and Uncertainties

Several factors served as limitations for this study and reduced the level of accuracy, namely: incomplete or inadequate data due to limited availability and confidentiality, and time constraints. The following factors contributed to the accuracy of this study and created limitations on this study: the *EMME/2* model, bus fleet assumptions; and progress of the TRP.

#### 4.5.4.1 INRO *EMME/2*

Considering that the primary source of data for the study was modeled by the *EMME/2* software forecasting programme, the constraints within the model influenced the study. The lack of recent input material, due to the incorrect capture of CPTR 2012, did not enable an update of PT operations. The forecasts have been conducted according to the 2008 base-year model (with travel demands and population patterns from HTS 2008), which lacks spatial development and the use of the most accurate source, CPTR 2004, creates huge gaps in modeling.

The 2008 base-year model did not include the northern urban development corridor (NUDC) which consisted of development in Umhlanga and the Dube Tradeport due to the relocation of Durban International Airport for the 2010 FIFA World Cup. Problems were experienced as the NUDC scenario was modeled in 2009 using the 2005 base-year model, however, was not (transposed) input onto the 2008 base-year model. Therefore, only two options were available: forecasts with the 2008 population input data without the NUDC, or forecasts with the 2005 population data with the NUDC, and the 2008 option with latest HTS results were

---

preferable. The development of the Dig-Out Port, which consists of three phases to be completed in 2027 (Transnet, 2009), has not been incorporated into the model either. Therefore, traffic projections modeled on *EMME/2* did not include the effect of the new port on traffic flow and proposed freight routes for the transportation of goods to and from the harbour were not built into the future projections of *GO!Durban*. These trips, however, cannot be neglected as though not occurring.

Cancelled services and strikes by the PT network cannot be predicted, and therefore, are neglected by the programme.

In addition to that, of the three scenarios available on *EMME/2*, one scenario could be modelled at a time (Moodley, 2013a). Therefore, the AM Peak Hour flow for the BAU Scenario could be run, and then only could the PT vehicles for and the entire *GO!Durban* system be modelled. The concurrent modeling of scenarios is not possible. A 'phasing' scenario could not be run on *EMME/2*, as it would require a combination of both scenarios (tracking the development of *GO!Durban*, which in itself was not created as a scenario. However, when *GO!Durban* is introduced and an increase in congestion is caused during the construction and implementation phases (due to lane reduction) it cannot be modeled and subsequent emissions cannot be measured. This might not truly reflect traffic flow, especially in the undesired case of the continuation of the existing PT system after the implementation of *GO!Durban*.

#### *4.5.4.2 Bus Fleet*

The bus sector operating within the EMA does not only comprise subsidised buses, however, a generalisation was made about the bus system, due to limited access to information. Since the buses subsidised by the EM receive a third of bus fares spent in the region, it was assumed that the subsidised fleet was an adequate representation of the sector. Daimler refused to provide any data on the buses in the subsidised fleet. Private companies, however, may operate vehicles that differ significantly (with various technological advancements) nevertheless, due to unwillingness of private companies to cooperate, these were not included. Several private companies, such as KZN Transport and Olympic Bus Lines, were approached, with no response. Although fleet age and technology development influence vehicle emissions, the subsidised bus fleet served as an adequate representation.

---

The selection of the same bus for *GO!Durban* complementary and feeder routes was motivated by the vehicle capacity assumptions in the *EMME/2*, according to ETA. Although this may result in an over-estimation of emissions, the conservative approach was adopted for the purpose of this study.

#### 4.5.4.3 Minibus-Taxi Fleet

Vehicles introduced by the TRP (Appendix A) include the Toyota Quantum/Ses'Fikile. For the purpose of this study, it was assumed that majority of old vehicles were replaced by the Toyota Quantum/Ses'Fikile (BAU Scenario). This is an accurate generalisation due to limited availability of data. Considering the success rate of scrapping in KZN, the TRP would have continued to 2022 until all 13 000 minibus-taxis were replaced. ETA, however, ended the programme in 2010 (Naidoo, 2014), due to the next phase of the PTAP and incorporation of the minibus-taxi industry in the IRPTN. The BAU Scenario considered Phase One of the PTAP to completion, in the event of Phase Two not being implemented.

No local fuel consumption data was available for the 2002 Toyota HiAce, hence, international fuel consumption factors were used.

## 4.6 Summary

This study is restricted to the total operational emissions (due to fuel consumption by vehicles) of the PT fleet in the EMA and does not include embodied emissions from the manufacturing process or construction activities of the network. It required both a theoretical and case study approach to meet the aims and objectives set in Chapter 1. An attempt to accurately calculate the CO<sub>2e</sub> emissions of the existing PT fleet and those expected by the *GO!Durban* network was made in this study. Critical to this study was the PTAP as each scenario focused on the phases to be implemented; BAU Scenario – Phase One, and *GO!Durban* – PTAP to completion in 2030 including a 20% modal shift to PT.

The primary source of data was *EMME/2* traffic forecasting software which is the modeling programme used by ETA to assist in transportation planning. The projections were built on the 2008 base-year model, according to the results of the HTS 2008 and 2004 CPTR. The CPTR for 2003/2004, which would differ from the 2013 CPTR, was used as it was the only accurate record available at the time of the study. Hence, a level of uncertainty was created

due to changes in PT since 2004 and spatial development post 2008, as the model was not updated to include the development of the NUDC or Dig-Out Port, consequent trips generated and the influence on traffic. In addition, it and could not run combinations of scenarios (and track development of the *GO!Durban* system), limiting modelling of future events.

The calculation of vehicle emissions of *GO!Durban* was limited by preliminary plans of the IRPTN. Road vehicle procurement for *GO!Durban* is yet to occur, therefore the greatest uncertainty of the study was created in vehicle selection. Seeing as emission standards of the vehicles have the greatest impact on GHG emissions of the system, several scenarios considered the potential vehicles selected based on requirements and vehicles operating in established IRPTNs in SA. Although detailed plans can change at any time, depending on the success of phases implemented, the latest revisions of plans were used for the purpose of this study.

## CHAPTER 5

### DATA MODELING AND ANNUAL RESULTS

#### 5.1 Introduction

This section presents the validation of the *EMME/2* base-year model (as calibrated by ETA) and conversion factor for annual results. Based on these validations, the forecasts have been extracted from *EMME/2* and factored to produce annual projections for the existing PT System Scenario and the *GO!Durban* Scenario.

#### 5.2 The *EMME/2* 2008 Base-Year Model

As specified in Section 4.5.1, two methods of factoring *EMME/2* AM Peak Hour outputs to annual results for 2008 exist and are shown in Figure 5-1. The significant difference in the yearly passengers boarding PT evident can be attributed to the conversion factor applied.

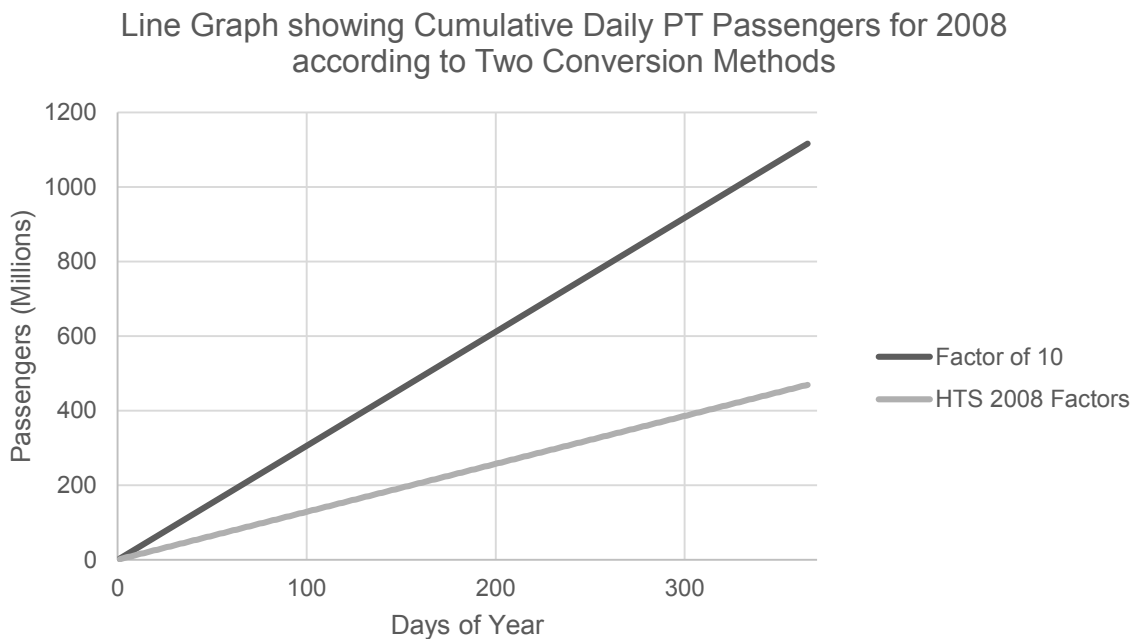
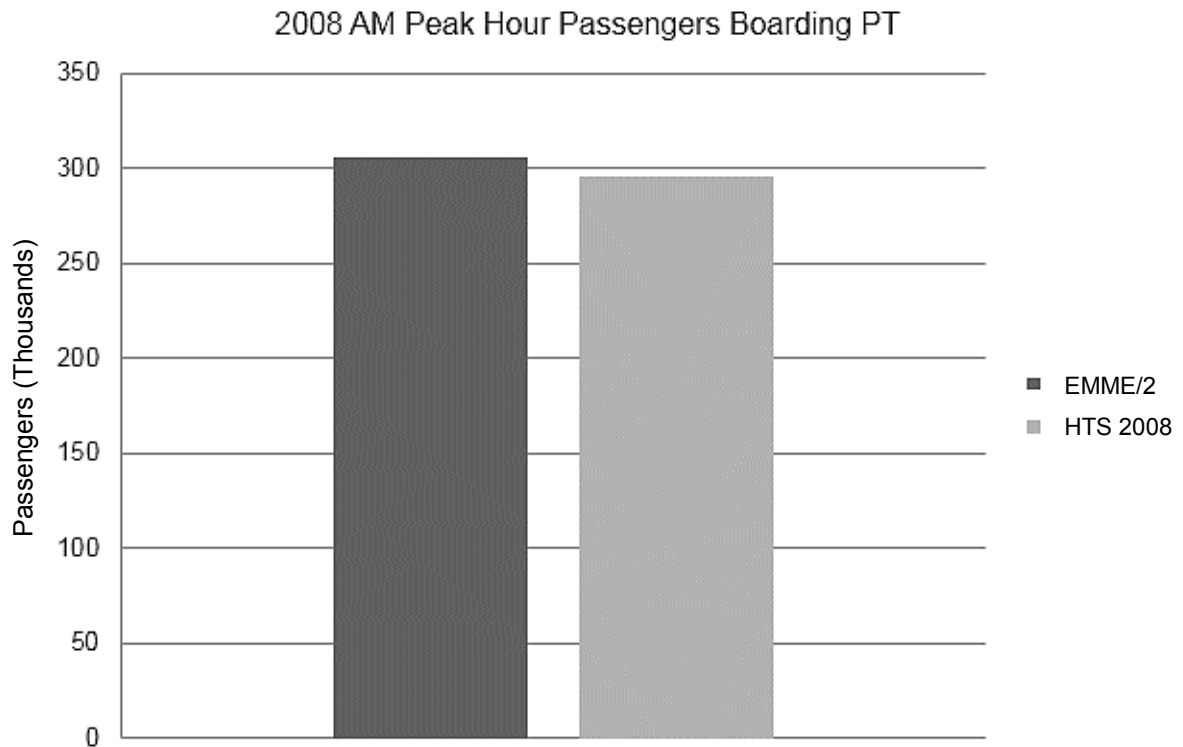

**Figure 5-1: Passengers Boarding PT modes in 2008 for Conversion Factors**



It is evident that the passenger results are directly proportional to the factor applied, therefore, the two lines in Figure 5-1 diverge as time increases. The pair of annual results achieved for 2008 differ by 647,2 M PT passengers. The application of the 'Factor of 10' produces annual passengers 2.4 times greater than the 'HTS Factor' over one year. This deviation projected over 20 years to 2030 (in millions) has a major impact on this study.

The *EMME/2* 2008 PT passenger model can be seen alongside the results of the HTS 2008, in Figure 5-2.



**Figure 5-2: Comparison of 2008 *EMME/2* and HTS Results**

The AM Peak Hour passenger results of *EMME/2* (305 732) and HTS 2008 (295 600) displayed differ by 3.3%. HTS 2008 is considered to have captured only 90% of Peak Hour data, indicating a margin of error of approximately 10% (GOBA Consulting et al., 2012b). This indicates that HTS 2008, as the source of population data and passenger behaviour inputs, aided in the development of the 2008 base-year model utilised by ETA for *EMME/2* forecasts. The route and vehicle information resulting from CPTR 2004 was reflected in the

outputs. Hence the application of ratios of peak and off-peak periods as obtained from HTS 2008 would produce the most accurate results for the purpose of this study.

### **5.3 PT Sector Projections for eThekweni Municipality**

The forecasts extracted from *EMME/2* are presented in this section as annual projections up to 2030, according to two scenarios, namely the existing PT system (BAU) and *GO!Durban* (PT intervention). Within each scenario, the following projections are examined: annual PT passenger demand, total mileage by PT vehicles (vehicle-kilometres), passenger distances (passenger-kilometres) and AM Peak Hour Vehicle Requirements.

#### **5.3.1 Existing PT System Scenario**

This section presents the projections of the existing PT system according to the methodology specified in Chapter 4. For the purpose of this study, the low-population growth forecasts extracted from *EMME/2* for the existing PT modal split represents the BAU Scenario. It assumes that the modal share between the POV and PT sectors remains unchanged over the entire projection. The BAU Scenario implies 'growth without constraints' or 'growth according to existing government policy'. This scenario considered projections of the existing PT system and was carried out with the assumption that no PT interventions were implemented (other than fleet renewal and maintenance).

Population growth and an increasing transportation demand will have a significant impact on PT passenger usage over the next 20 years. Figure 5-3 indicates the number of passengers boarding PT modes per year from 2008 to 2030 for the low growth projection.

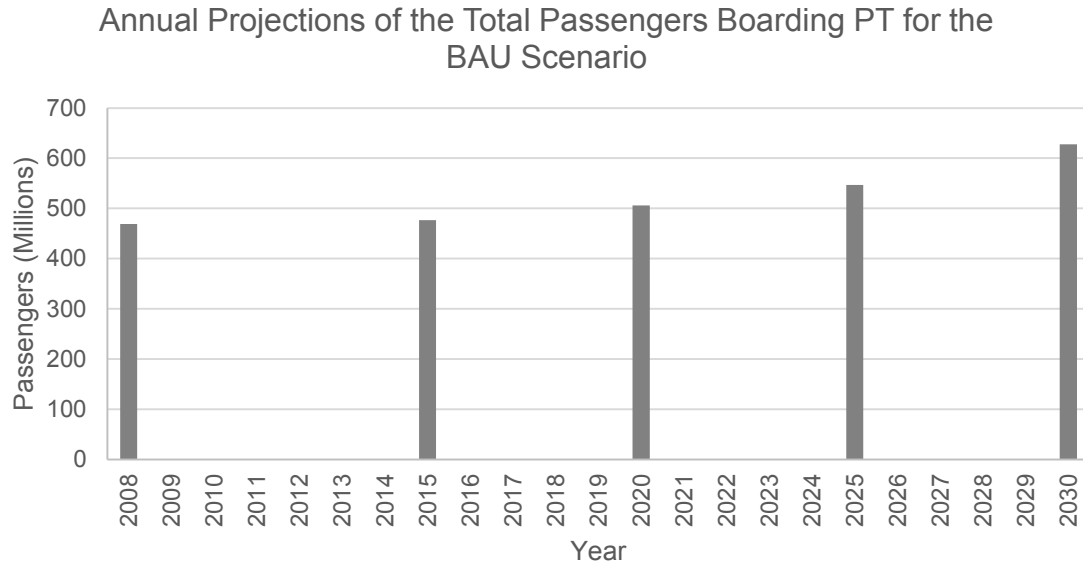

**Figure 5-3: Projections of annual passengers boarding PT modes up to 2030 for the BAU Scenario**

Figure 5-3 displays an increasing trend, with the forecast reaching a peak in 2030 at almost 628M boarding passengers, a 34% increase compared to the HTS of 2008. Passenger numbers increase gradually from 469 M (2008) to 478 M (2015), then rise to 505 M (2020) and 547 M (2025), and intensify to 2030. Considering the increasing South African population, an incline in commuters is anticipated, specifically PT passengers searching for transportation at minimum cost. It must be noted that the population growth rate increases after 2020 for many reasons, one being the reduction in the spread of AIDS in the EMA. Along with the rise in passengers, is the requirement of additional PT vehicles to accommodate them. The capacity of different modes of PT is crucial for modal choice and trip assignment, along with the service capacity and utilisation of roadways and trains.

The AM Peak Hour, during which passenger travel is at its peak, is when the maximum number of vehicles are required. These vehicles will be used daily to complete the essential trips. The required PT vehicles for the AM Peak Hour, according to the trip assignment by *EMME/2*, are displayed in Figure 5-4.

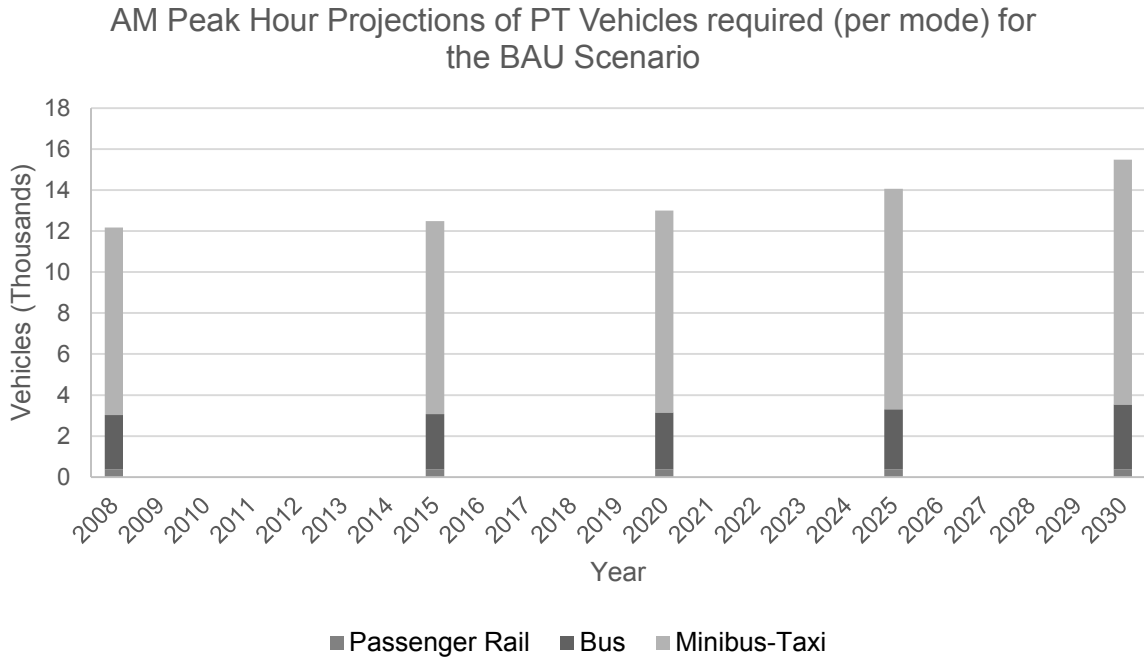
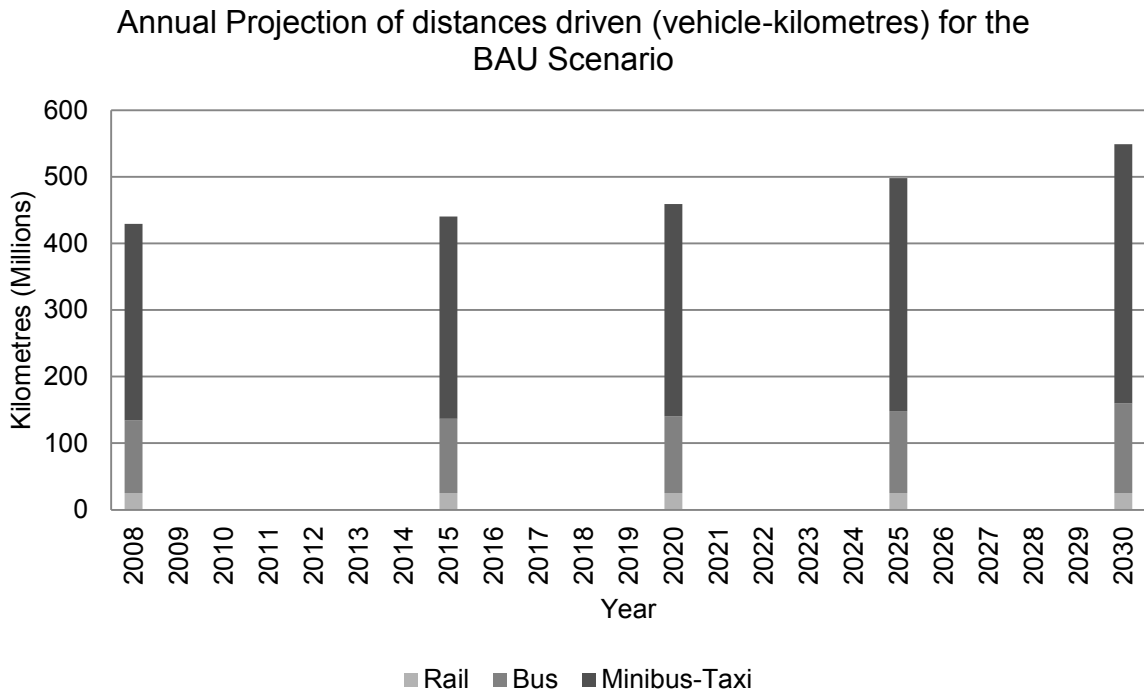

**Figure 5-4: AM Peak Hour Vehicle Projections for the BAU Scenario (ETA, 2012b)**

An overall increasing trend in the number of required vehicles is shown in Figure 5-4. The projections correspond to the rising PT passengers for the BAU Scenario. The 2030 projection is 27% more than the 2008 projection. In 2008, 9 148 minibuses-taxis and 2 646 buses are required, which increase to 11 930 and 3 172 in 2030, respectively. The greatest increases of 8% and 11% are seen between 2025 and 2030 in buses and minibuses-taxis, respectively. As shown, the number of trains appears constant, however, subsequent rises in passenger demand can be accommodated by the addition of coaches (and engines if required) to a train set. The greatest increase is observed in the requirement of minibuses-taxis. This is predominantly due to the passenger capacity of a minibus-taxi, which is five times smaller than that of a standard bus and insignificant in contrast to trains. Contributing to the limited vehicle capacity is the level of accessibility of minibuses-taxis, which also serve as feeders (from residential areas) for the scheduled bus and rail trips.

In 2004, the PT fleet for the entire municipality consisted of 1 730 minibuses-taxis, 1 629 buses and 20 basic railway lines (GOBA Consulting et al., 2012b). In 2012, the minibus-taxi fleet had grown to 13 812 vehicles belonging to 120 taxi associations (ETA, 2012a). The growth of this industry will continue, in accordance with the increasing demand for mobility. The

subsequent rise in PT trips, hence travelled distances, due to the increasing population and PT passenger forecast is seen in Figure 5-5.



**Figure 5-5: Projected Total Trip Distances per Vehicle Category for the BAU Scenario**

As anticipated, overall travelled distances increase over the years from: 430M km in 2008 to 549M km in 2030. Figure 5-5 indicates that the 32% rise in minibus-taxi trips and distances from 295M km (2008) to 389M (2030) is greater than that of bus and passenger rail. Although rail vehicle-kms appeared non-changing, the addition of coaches to a train set increases the capacity along a route and passenger-kilometres (P-kms), whilst maintaining a constant trip length and one train trip. Buses can accommodate more passengers, therefore, the entire distance travelled by buses would appear lower than P-kms.

Minibus-taxis travel more than three times the distance by buses to accommodate the passenger demand. Minibus-taxis with the lowest PT vehicle capacity, as previously mentioned, require a high frequency of trips to transport a large number of passengers. Hence, in terms of required road lanes, travel by minibus-taxi is not the favourable mode.

The other measurement of distance travelled is calculated according to passenger trip lengths for an applicable mode in P-kms, instead of vehicle mileages. This alleviates the issue of vehicle occupancy, as the measurement comprises the travel journey of the passenger, on condition that each trip is carefully monitored. The increasing population and requirement for mobility is translated into P-km forecasts per PT mode in Figure 5-6.

Annual Projection of passenger-kilometres per PT mode for the BAU Scenario

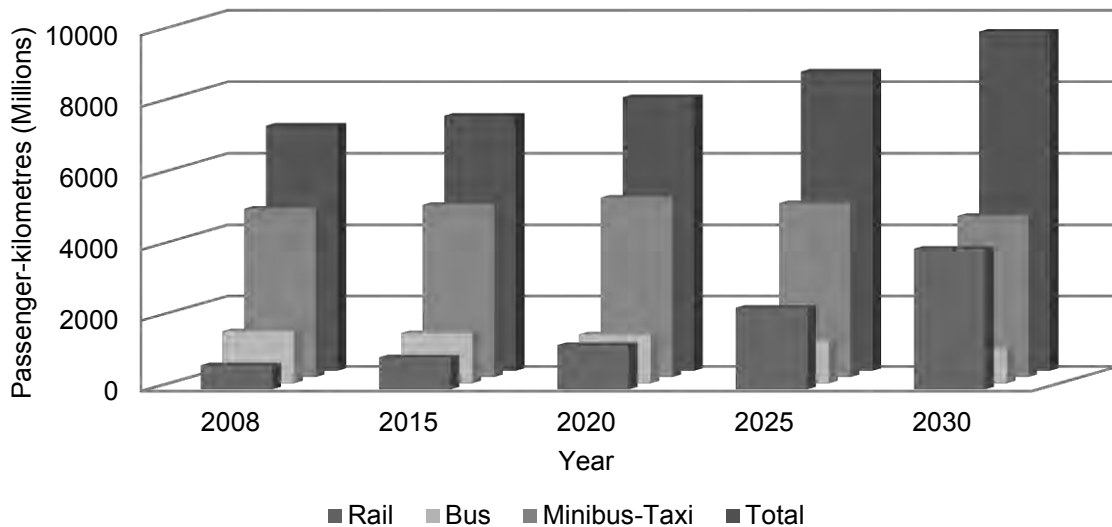

**Figure 5-6: Projected Passenger-km per Vehicle Category for the BAU Scenario**

An overall rise in projected P-kms is shown in Figure 5-6, indicating a 38% increase over 22 years. The minimum 2008 input is forecast to 9 525M P-km in 2030, with the most noticeable change between 2025 and 2030. The decline in bus projections from 1 468M P-km in 2008 to 998M P-km in 2030, is contrasted with the disproportionate rise in passenger rail projections from 681M P-km to 3 979M P-km, respectively. It is evident that passenger rail, with an overall increase of 485% in 2030, compared to 2008, indicates great favourability in the future and modal shift within PT.

Minibus-taxi P-kms increase from 4 748M (2008) to 5 058M (2020) and then drop to 4 548M P-km (2030). Road travel (bus and minibus-taxi), due to excess vehicles and roads congestion, would result in extended travel times. Road accident rates are much higher and

road closures due to accidents disrupt and may halt travel all together. Minibus-taxis serve as feeders, transporting major PT hubs and railway stations.

While travel by rail may require mode changes, due to limited routes between stations and not to specific passenger destinations, many rail passengers either do not have access to other PT or prefer to walk for cost savings. Another advantage of rail is limited time delays, which are only experienced during interruptions in train schedules or malfunction of trains, in comparison to road travel in which congestion may be experienced. Passenger rail is definitely the safer mode (in terms of passenger mortality rates), which provides services to all people at the lowest cost, especially along lengthy routes. Considering the number of passengers that can be transported at once along a densely populated corridor, rail is the most efficient mode.

### **5.3.2 The *GO!Durban* Scenario**

This section pertains to the IRPTN, *GO!Durban*, to be introduced in the EMA. The projections of *GO!Durban* are done according to the implementation schedule listed in Chapter 3, however, due to limitations on scenario modelling, only the fully operational network planned to be implemented by 2027 is considered in the 2030 forecast.

In 2009, only 22% of expected passengers actually used Phase 1A of the *Rea Vaya* BRT system (City of Johannesburg, Planned versus actual performance *Rea Vaya*, 2010). Considering this success rate, for the purpose of this study, the following two projections will be considered: Target Modal Split (modeled according to a high-population growth factor and 20% modal shift from POVs towards PT) and Existing Modal Split (no modal shift). It is, however important to note that although passenger projections vary, the *GO!Durban* Scenario emissions only consider the designed route frequencies, as specified by the network. While the number of vehicles (required due to trip time) varies, the same vehicle headways (number of trips) and distance travelled resulted for both projections. As congestion increases due to the number of POVs on roads, so too does trip time, and the interaction between road vehicles and *GO!Durban* vehicles (not operating on reserved lanes) must be noted.

*GO!Durban* is the PT intervention introduced by national government to provide improved services and ultimately increase PT patronage. The 'high-population growth' projection

---

examines the application of maximum population growth factors, however, passengers of this magnitude cannot be accommodated on the road network according to the existing POV:PT split. Therefore, as stipulated by PTAP, a passenger modal shift of 20% towards PT is generated by the *GO!Durban* Scenario, according to the Target Modal Split (TMS) projection. The existing modal split (EMS) in the EMA, in the result of a low-population growth does not produce a modal shift and vehicles increase at the existing modal split of 44:56 (private:public) (Moodley et al., 2009). This is possible due to passenger figures not reaching the design capacity of *GO!Durban* (worst case) or the rebound effect, encouraging POV usage.

The comparison of PT passenger demand projections for the entire operational network is displayed in Figure 5-7.

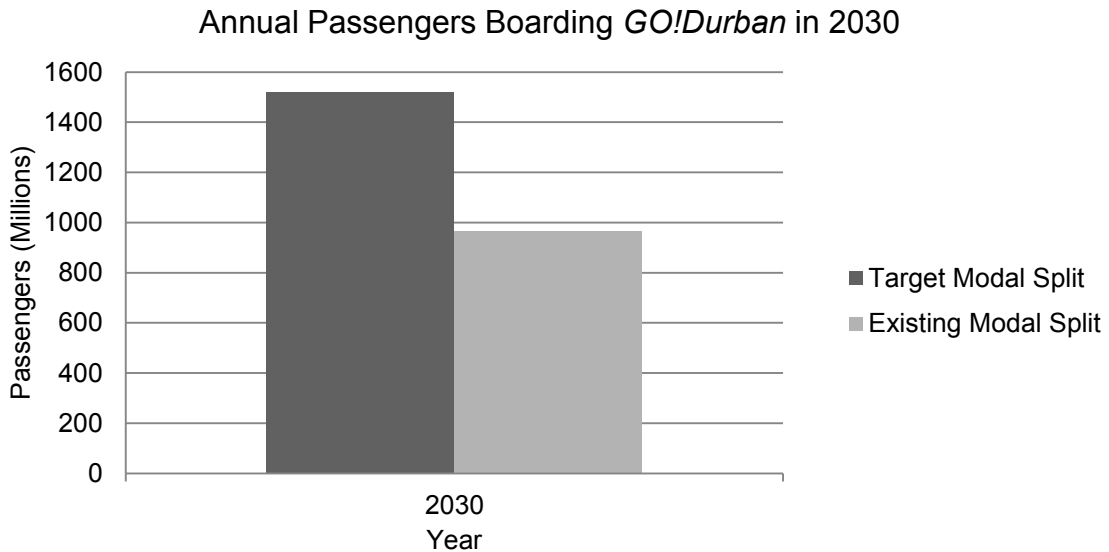

**Figure 5-7: Annual Passengers Projected for *GO!Durban* in 2030**

Due to the great transportation demand within the EMA, a PT passenger projection of 1 519M would ideally reduce the growing congestion on the remaining road network in 2030. Maintaining high patronage of *GO!Durban* would not only translate to a halt in the increasing number of POVs on the road, but ensure the success of the system. The total PT passenger forecast for the EMS projection in 2030 is 966M, which is solely attributable to the existing population trends and growth factors within the EMA. The EMS in comparison to the stipulated modal shift produces passenger projections approximately 36% lower. The annual



553M private vehicle passengers that would, without the modal shift towards *GO!Durban*, otherwise have utilised the mixed-traffic road network are an indication the implication of the PT modal split.

Although the same vehicles will operate daily along the routes of *GO!Durban*, the maximum PT vehicles required for the AM Peak Hour, are displayed in Figure 5-8.

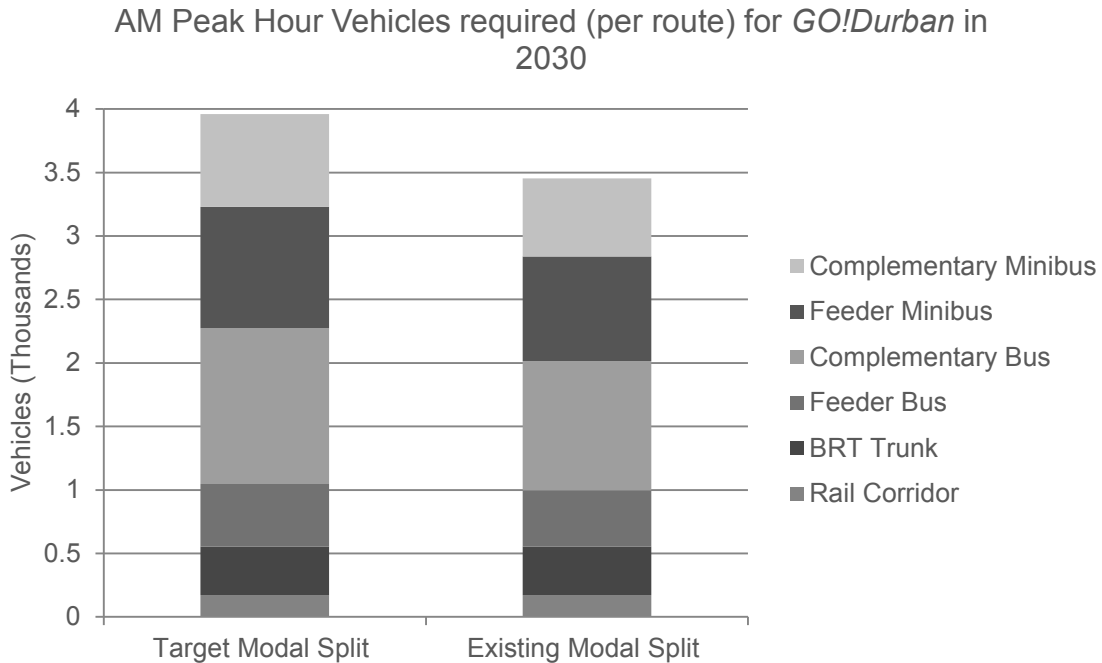

**Figure 5-8: AM Peak Hour Vehicle Projections for *GO!Durban* (ETA, 2012b)**

In 2030, 3 960 PT vehicles are required by the TMS projection and 3 453 by the EMS. The TMS projection is 15% more than the EMS projection for 2030, displaying the increase in PT vehicles according to the required modal shift. The difference between the two projections exists due to congestion on roads (and increases trip time along mixed-traffic routes). Since feeder and complementary vehicles do not travel along priority lanes, the number of trips that can be done by one vehicle in an hour is reduced. For the TMS projection, an additional 507 PT vehicles will be on the eThekweni road network in the AM Peak Hour in 2030, an estimated additional nine vehicles per minute. This must be considered along with the other road vehicles for the case of high-population for 2030. This projection investigated a 20% modal shift from POVs to PT, therefore, a minimum additional

4 877 POVs would result on the road during the AM Peak Hour in the absence of the modal shift (assuming POV occupancy of four and considering every bus and midibus would have equated to 15 and four additional cars on the road, respectively). This contribution to congestion and delayed travel time validates the decision for adequate steps to be taken in achieving the necessary objective of modal shift to PT.

For the TMS projection, 10% of vehicles are articulated buses (along trunk routes), 43% of the vehicles are standard buses followed by midibuses (42%), as the BRT is a bus-based system. This was a 32% increase in standard buses and 35% more midibuses (along feeder and complementary routes) in comparison to the EMS vehicle requirement.

The total distances travelled by the vehicles of *GO!Durban* shown in Figure 5-9 (as a result of specified vehicle frequencies along routes) are critical to GHG emissions produced. The network has been designed with specific vehicle headways (frequencies) along routes, therefore, travelled distances remain constant for both projections.

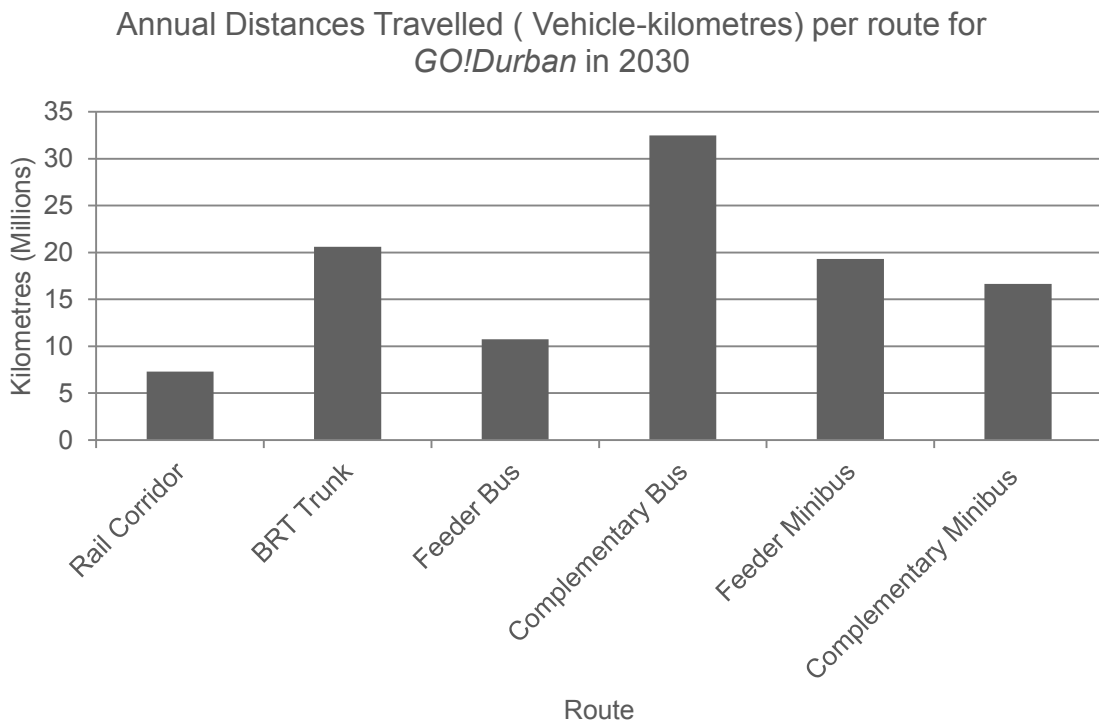

**Figure 5-9: Annual Distance Travelled per Vehicle Category for the *GO!Durban* Scenario**

The full operational *GO!Durban* fleet produces 107M kms annually. It is expected that BRT trunk buses travel the longest distance as these are main routes with the lowest vehicle headway, however, it is important to note that the distance travelled by complementary buses is 58% more than BRT trunk routes. This serves as an indication of the vastness of the complementary service, with long-length routes away from the trunk routes. The midibus services of the feeder routes correspond to the reduced capacity of the vehicle, in contrast to the feeder bus services which require fewer trips (reduced vehicle-distances) due to higher capacity.

The overall success of *GO!Durban* is dependent on passenger usage of the system. Figure 5-10 displays passenger travel for the both projections in 2030.

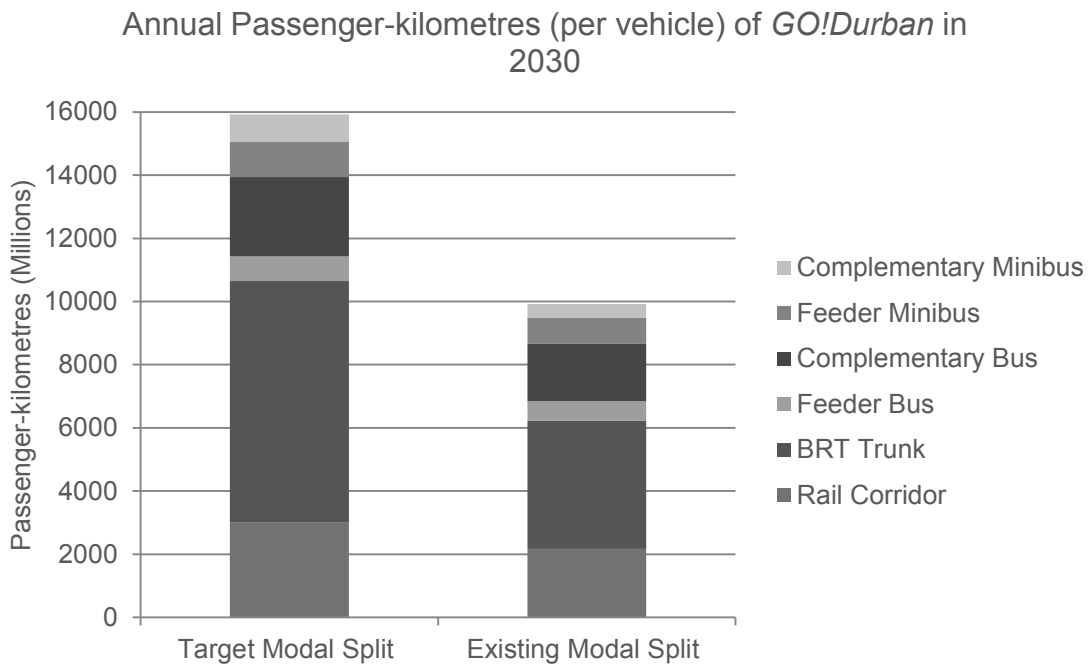

**Figure 5-10: 2030 Passenger-kilometres per Vehicle Category for the *GO!Durban* Scenario**

In 2030, 15 926M P-kms are forecasted for the TMS and 9 917M P-kms for EMS, as shown in Figure 5-10. The stipulated modal shift represents a 61% increase to the TMS P-kms.

The dominant route in the TMS projection is BRT Trunk Routes (48%), followed by complementary routes (21%), the rail corridor (19%) and feeder service (12%). The trunk

routes of the corridors consist of 67% of total passenger trips, emphasising the density and demand along the trunk routes. Bus routes comprise 69% of total 2030 P-kms, indicating the central mode and design capacity of the routes.

BRT trunk routes display the greatest decrease in passenger distances of 3 575 P-kms, in comparison to TMS. Travel along complementary midibus routes of the EMS projection are half those of the TMS in 2030. Trunk routes account for 73% of the overall decrease from the TMS to the EMS projection. Higher projections, according to the TMS, indicate an increase in ridership along the densely populated trunk routes as expected due to advantageous travel times in the priority lanes. This reaffirms the requirement of quicker services offered by the trunk routes.

#### **5.4 Summary**

The traffic outputs extracted from EMME/2 (modelling by ETA) have been validated (within a 95% confidence level) with the travel patterns observed by the HTS of 2008. Conversion of the AM Peak Hour outputs to annual traffic data was done in accordance with modal split proportions obtained from the HTS of 2008. The low growth (existing modal split) and high growth projection scenarios were used. The BAU Scenario followed the existing PT ridership (44%) and the *GO!Durban* Scenario the TMS according to and 20% modal shift towards PT.

Passenger projections of the BAU Scenario increase by 34% from 2008 to 2030. The upsurge of minibus-taxis, in comparison to buses and trains, is due to the accessibility and function of the service and limited capacity of the vehicle. The rapid increase of P-kms of rail services is an indication of the capacity and favourability of the PT mode as fast, safe and convenient. The 2030 *GO!Durban* Scenario indicated the greatest distances travelled along complementary bus routes and highest P-km along BRT trunk routes, due vastness and length of complementary routes and increased capacity of articulate buses, respectively. Passenger projections of the TMS and EMS scenarios differed by 36%.

## CHAPTER 6

### RESULTS AND DISCUSSION

#### 6.1 Introduction

This chapter provides critical analyses and summaries of the annual CO<sub>2</sub>e emission results obtained from the investigation of the PT system within the EMA. The methodology specified in Chapter 4 was applied to the following scenarios:

- BAU Scenario;
- *GO!Durban* Scenario; and
- Comparison of BAU and *GO!Durban* Scenario.

The phases of the PTAP are considered in these scenarios, namely the accelerated fleet renewal in the BAU Scenario and implementation of the PT intervention in the EMA in the *GO!Durban* Scenario.

#### 6.2 BAU Scenario

This section presents the forecasted operational CO<sub>2</sub>e emissions of the “growth without constraints” scenario according to three technology options. This involved the assessment of the total emissions of the existing PT system under current government policy, including fleet renewal and maintenance requirements with no consideration of major PT interventions.

##### 6.2.1 Option 1

This option involves the refurbishment of the existing Metrorail rolling stock, as well as the replacement of buses and minibus-taxis with the Scania K270 4x2 (Euro IV) and Toyota Quantum/Ses’Fikile (Euro II) at the end of their useful life.

The annual emissions produced by the projection from 2008 to 2030 are displayed according to emissions per PT mode (in a stacked bar graph) in Figure 6-1.

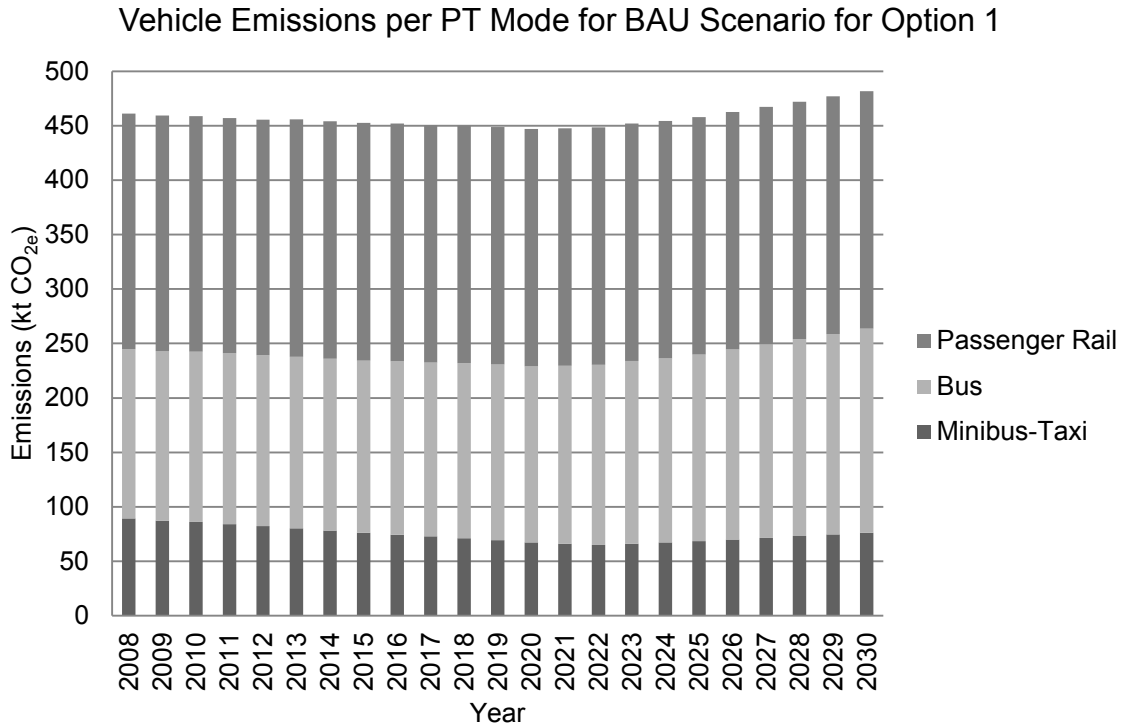

**Figure 6-1: Total Emissions for Option 1 of the BAU Scenario**

The vehicle emissions shown in Figure 6-1 display a range of 32 kt CO<sub>2e</sub>. An overall increase in total emissions from 461 040 t CO<sub>2e</sub> in 2008 to 481 609 t CO<sub>2e</sub> in 2030 is shown. The passenger rail service produces the greatest emissions, followed by the bus and minibus-taxi industry.

Bus emissions display a rise from 155 464 t CO<sub>2e</sub> (2008) to 187 286 t CO<sub>2e</sub> (2030) due to increase in travelled distances along bus routes. These significant emissions account for 39% of the total emissions in 2030 and are responsible for the rise in the last five years of the projection. Passenger rail, comprising approximately 46% of annual emissions, is expected to be a more efficient vehicle mode than buses. The ageing fleet belonging to PRASA, procured in 1958 (PRASA, 2007) has undergone refurbishment, however, has never been replaced due to a shortage of funds, therefore cannot ensure lower emissions. Although distances travelled by minibus-taxis increase the most (32% from 2008 to 2030), the introduction of new vehicles by the TRP reduces emissions to below 80 kt CO<sub>2e</sub>. The overall consistency of total emissions is primarily due to the considerable impact of the TRP.

### 6.2.2 Option 2

This option investigated the projection of vehicle emissions with the application of a 99% annual technology improvement factor (CDM, 2011) to the existing bus and minibus-taxi fleet. The passenger rail rolling stock remained unchanged, however, the planned reduction in the Eskom electricity generation CF was incorporated (Eskom Holdings Limited, 2011).

The expected PT emissions from 2008 to 2030 are shown in Figure 6-2.

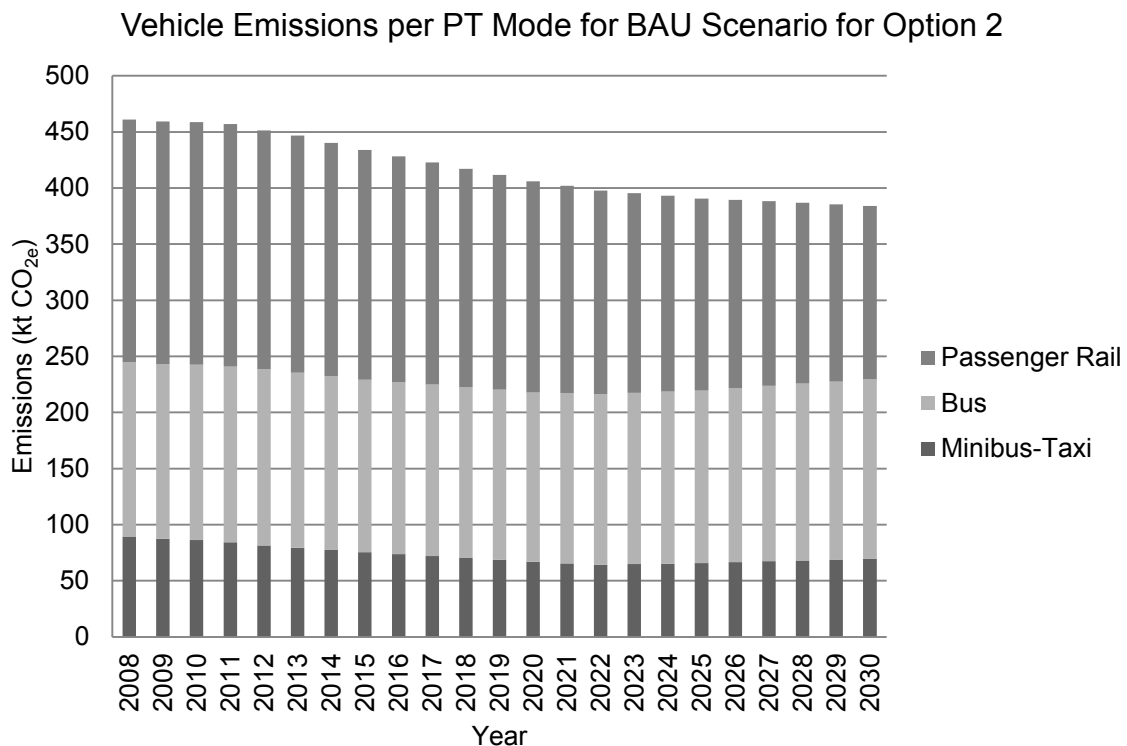

**Figure 6-2: Total Emissions for Option 2 of the BAU Scenario**

The annual emissions in Figure 6-2 display a declining trend, with emissions decreasing from 461 040 t CO<sub>2e</sub> (2008) to 383 941 t CO<sub>2e</sub> (2030), solely as a result of the technology improvement factor advised by AM0031 (CDM, 2011).

Over the entire projection, bus emissions range between 150 kt CO<sub>2e</sub> and 160 kt CO<sub>2e</sub> due to the overall increase in travelled bus distances by 23%. The bus service emits 34% of total emissions in 2008, which rises to 42% in 2030. Minibus-taxis release the least emissions

due to the TRP, with only 18% of total emissions in 2030. Eskom’s attempts to improve the environmental footprint of electricity generation even with the growing demand up to 2030 (Eskom Holdings Limited, 2011), has significantly reduced emission forecasts of Metrorail. The mode displays a 29% decrease in emissions (from 2008 to 2030), the most substantial among the PT vehicles. Although passenger rail produces the most emissions over the projection, the bus service emissions exceed those of the rail fleet in 2030, due to passenger capacity and efficient electricity generation of rail.

### 6.2.3 Option 3

The latest estimated technology developments were considered up to 2030. Buses were replaced with the Volvo B7R (Euro V) and minibus-taxis with Mercedes Benz Sprinters (Euro V) at the end of useful life. Together with the Eskom efficiency goals, the new rolling stock, X'Trapolis Mega, was introduced steadily over 10 years, replacing the existing PRASA rolling stock.

The CO<sub>2</sub>e emissions (per mode) for Option 3 are displayed in Figure 6-3.

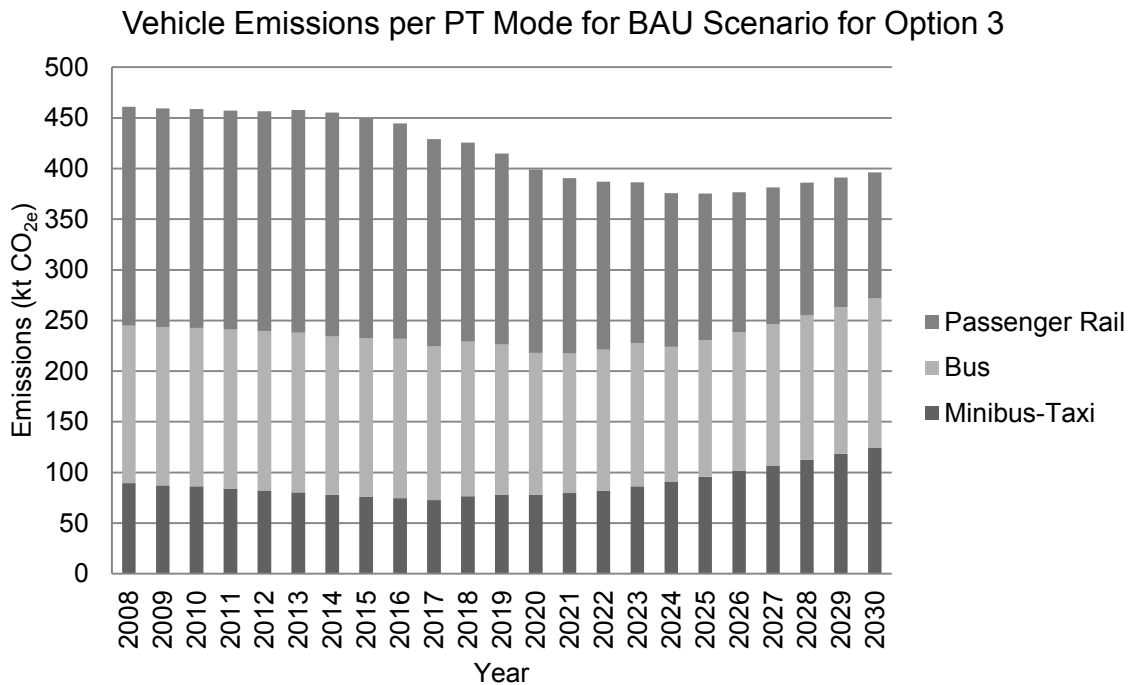

**Figure 6-3: Total Emissions for Option 3 of the BAU Scenario**



The annual emissions produced for this technology advancement option do not exceed 465 kt CO<sub>2</sub>e. As shown in Figure 6-3, emissions remain fairly constant from 2008 (461 040 t CO<sub>2</sub>e) to 2014 (455 129 t CO<sub>2</sub>e). A decreasing trend is demonstrated to 2025 (375 278 t CO<sub>2</sub>e) during the replacement of the PRASA rolling stock with the X'Trapolis Mega. Thereafter, emissions increase to 396 315 t CO<sub>2</sub>e in 2030. In 2008, passenger rail comprises 47% of total emissions, followed by bus emissions (34%) and minibus-taxis (19%). In 2030, even with the increased favourability of rail services, the combined bus and minibus-taxi service emissions encompass 69% of total emissions.

After the switch to newer, safer and more energy efficient vehicles, the emissions of the minibus-taxi industry increase according to rising passenger usage. The percentage of minibus-taxi emissions is equal to that of passenger rail emissions. Although minibus-taxis provide an essential service as feeders and connectors between railway stations and destinations, passenger rail services are competitive with the additional advantage of travel along railway tracks without road traffic. The 42% decrease in passenger rail emissions is predominantly due to the introduction of the X'Trapolis Mega, coupled with the sustainability plans of Eskom, highlighting the impact of PRASA rolling stock. Bus emissions reach their lowest in 2024 (133 kt CO<sub>2</sub>e) when the entire fleet consists of Volvos (of Euro V Emission Standard), thereafter increasing with intensifying trip distances to 2030 (148 kt CO<sub>2</sub>e). The overall 14% decrease in total 2030 emissions in comparison to 2008, even with increasing passenger trip projections, iterates the benefit of technology upgrades.

#### **6.2.4 Emissions Comparison**

The existing PT system in the EMA comprises a passenger rail service, a bus system and minibus-taxi industry. The GHG emissions produced according to various vehicular technologies are summarised in Figure 6-4.

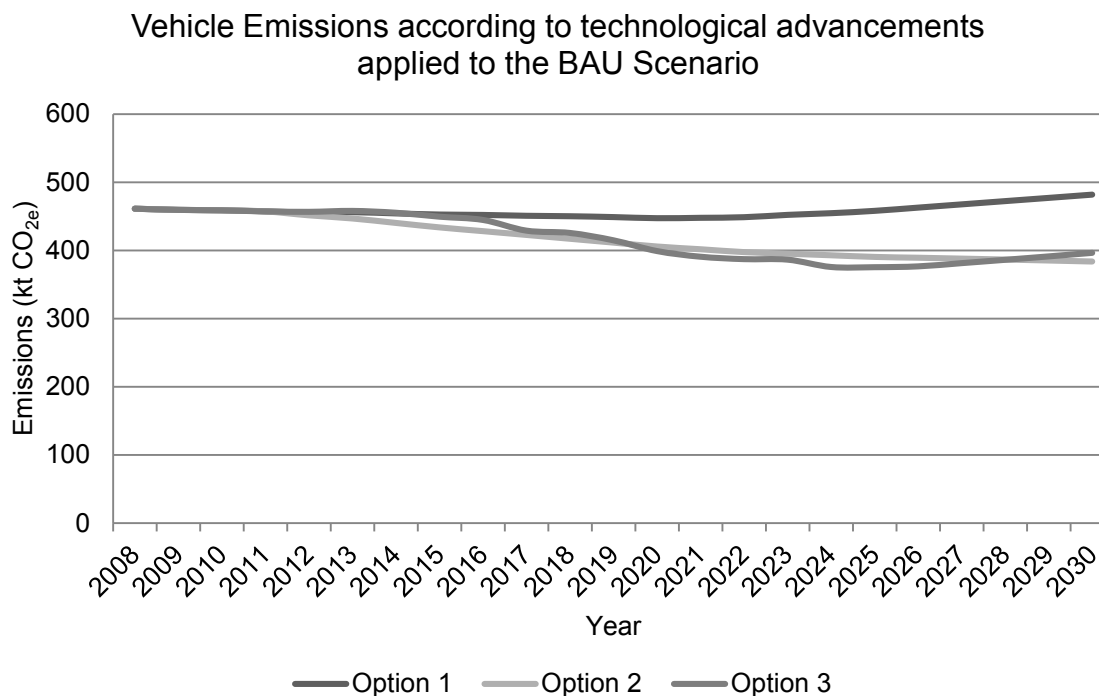

**Figure 6-4: Total Emissions Comparison for all Options of the BAU Scenario**

As displayed in Figure 6-4, all profiles of the BAU Scenario do not exceed 500 kt CO<sub>2e</sub>. Option 1 produces the greatest emissions; in excess of 440 kt CO<sub>2e</sub>. Option 2 indicates a steady decline and greatest decrease in emissions due to annual improvements in fleet to accommodate fuel advancements and undetermined vehicle upgrades. Option 3 displays distributed drops due to fleet replacement to 397 kt CO<sub>2e</sub> in 2030.

The overall trends produced by the projections are: increasing (Option 1) and decreasing (Option 2 and 3). With refurbishment of the existing PT fleet, Option 1 indicates an overall 5% increase in 2030 compared to 2008. In 2030, Option 2 and 3 display decreases of 17% and 14%, respectively, in comparison with 2008. This serves as an indication of the importance of new fleet developments and the impact of selection.

In 2030, Option 1 produces 482 kt CO<sub>2e</sub> and Option 2, 384 kt CO<sub>2e</sub>, the utmost and least annual expected emissions of the BAU Scenario. When considering the average emissions for each option, Option 2 and 3 are the most effective with 418 kt CO<sub>2e</sub> annually, followed by Option 1 (458 kt CO<sub>2e</sub>). In terms of sustainability, although vehicle advancement has not been specified, Option 2 produces the most eco-friendly solution. It is apparent that the BAU

Scenario according to Option 1 is not a desired outcome. While Option 3 is dependent on the rate at which new rolling stock is introduced, with defined optimum technology advancements, it is the more accurate alternative. Examining the consequence of modal assignment, the contribution of each mode to the overall 2030 emissions for all Options are summarised in Figure 6-5.

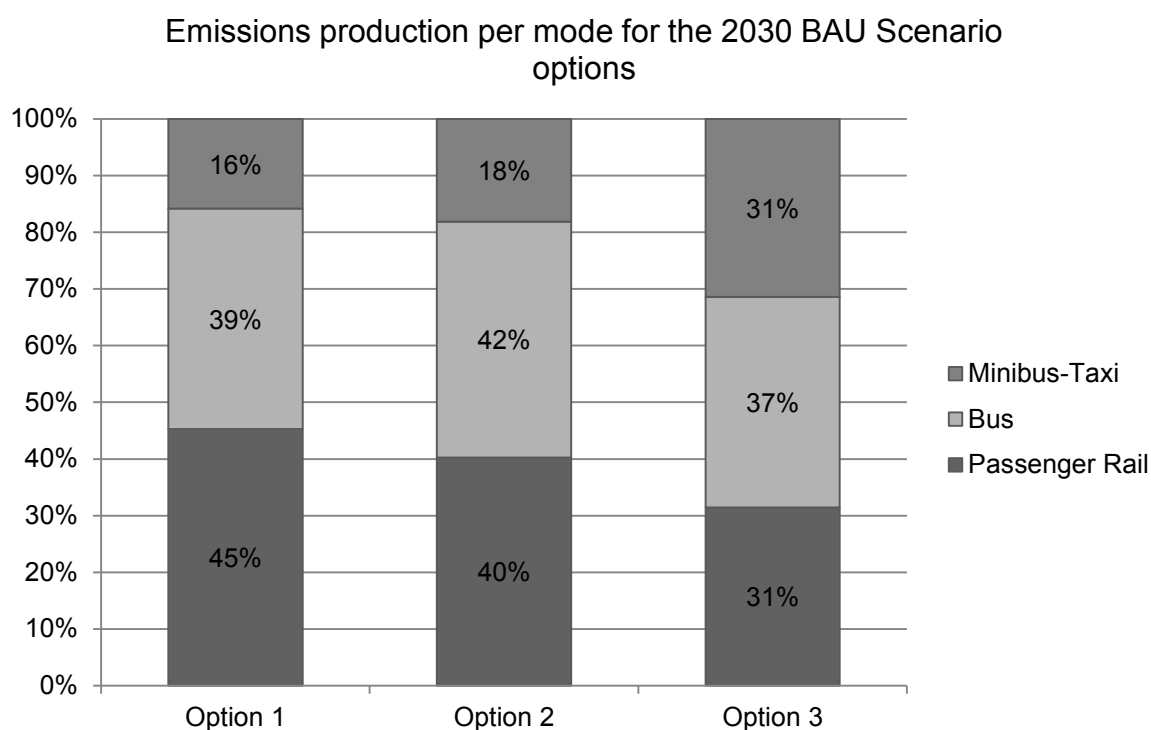

**Figure 6-5: Emission Split per Vehicle Category for all Options of the BAU Scenario**

In 2030, Option 1 and 2 display similar compositions of emission, however, a slight shift away from passenger rail is observed in Option 2 with the application of Eskom mitigation. The overall adjustment in the shares of emissions for Option 3 is due to the introduction of new rail rolling stock and Euro V vehicles, which has produced an increase in proportion of minibus-taxi emissions and decrease in bus and passenger rail emissions.

In 2030 despite the vehicle technology assigned, GHG emissions from the bus fleet exceed those released by passenger rail or the minibus-taxi service for Option 2 and 3. Although the greatest distance is driven by minibus-taxis (owing to the reduced passenger capacity), this mode still produces the least emissions over Option 1 and 2. The apparent increase in

the minibus-taxi segment of Option 3 is due to the introduction of a more advanced vehicles and the considerable decrease in passenger rail proportions.

The proportion of bus emissions is comparable for all options. Although the distance driven by buses is only 27% of minibus-taxis, this does not reflect in the share of emissions produced as bus emissions are more than double those of minibus-taxis in Option 1 and 2. Minibus-taxis are the most efficient mode, transporting 57% of the annual passenger demand and releasing only 16%, 18% and 31% of total emissions over all options. In Option 3 however, emissions produced by rail and minibus-taxis are equal, displaying the success of the X'trapolis Mega in reducing emissions.

During the peak periods, the high passenger demand of the rail service in one direction, results in low occupancy trains (with the same capacity) on the return trip. This may seem unproductive however, the passenger rail system is the most efficient means of transporting high volumes during peak hours. The subsequent rail emissions result from return trips cannot simply be measured as origin-destination trips of passengers, as coaches may be empty. Minibus-taxi services are different considering that trips are only made when the vehicles are full.

### **6.3 *GO!Durban* Scenario**

This section presented the expected vehicle emissions of the *GO!Durban* network to be implemented in the EMA. The anticipated timeframes specified by *GO!Durban*, however, indicate that the entire network will be online and functional in 2027 (EM, 2015a). Due to data modelling constraints, for the purpose of this study, 2030 was considered for the operational date of the entire system. The *GO!Durban* CO<sub>2</sub>e emissions produced over three technology possibilities are presented according to the vehicle frequency required for the passenger demand along routes.

Vehicles similar to those operating in *Rea Vaya* and *MyCiTi* were selected for use by *GO!Durban*. It is possible however, that smaller buses would adequately meet the demands along the complementary bus routes in the initial stages with lower ridership. Once fully implemented, however, larger buses may be introduced for greater capacity, as considered in this scenario.

### 6.3.1 Option 1

Considering the option of the same vehicles along the routes of Phase 1 of *GO!Durban* introduced for the other phases, the expected operational emissions of the network in 2030 are displayed in Figure 6-6.

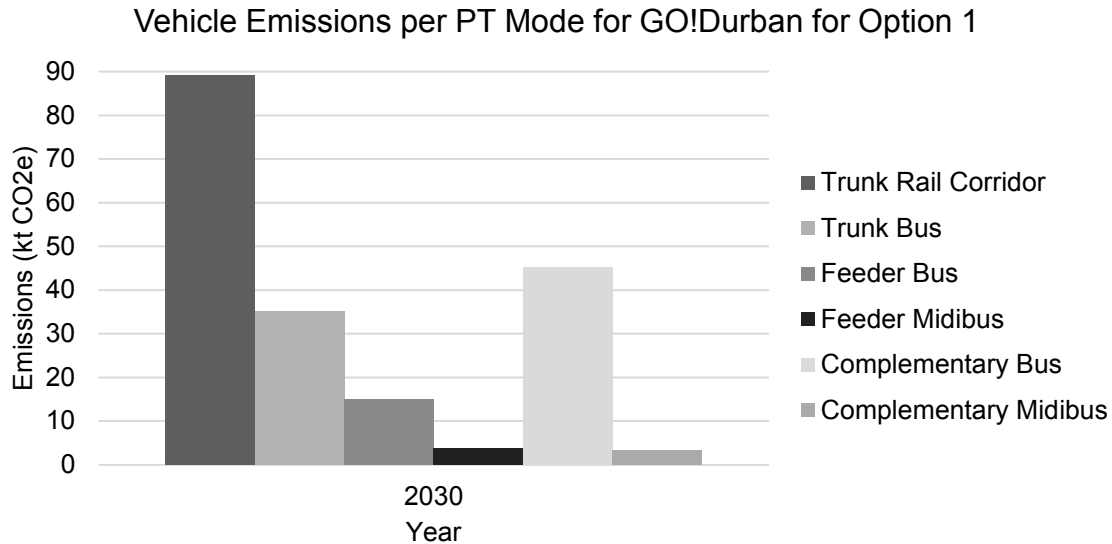

**Figure 6-6: 2030 Emissions per Vehicle Category for Option 1 of the *GO!Durban* Scenario**

The total emissions produced by the vehicles selected for *GO!Durban* start as the first corridor comes online in 2016 (EM, 2015a). Emissions of the network increase with the addition of corridors until the wall-to-wall system is achieved in 2027. Thereafter, the entire network is expected to stabilise and continue operation to the year 2030, for which an approximate 191 547 t CO<sub>2</sub>e will be emitted.

As displayed in Figure 6-6, the highest emissions are produced by the rail corridor, a trunk route for provision of services to 40% of eThekweni's PT demand (EM, 2015a). Therefore the anticipated result of 47% of total emissions is acceptable bearing in mind the safety of travel by rail, as well as convenience and advantage of ROW.

The remaining 53% of emissions result from the operation of road vehicles. Complementary buses produce the greatest bus emissions, followed by BRT trunk buses and feeder buses, in proportion with the respective distances driven along the routes. Emissions from

midibuses comprise less than 2% of 2030 totals each, an efficient result for their combined 36% of total road trip distances.

Trunk routes produce 65% of total emissions, followed by complementaries (25%) and feeder routes (10%). Reducing emissions along complementary routes would require customising each route according to passenger demand, with larger buses for major demand and midibuses for small demand. Adjustment to preliminary plans, however, can only be made once the system has been implemented and gaps established.

### 6.3.2 Option 2

The total operational emissions for the entire *GO!Durban* network according to annual technology improvement factors applied from Phase 1 to 2030, are displayed in Figure 6-7.

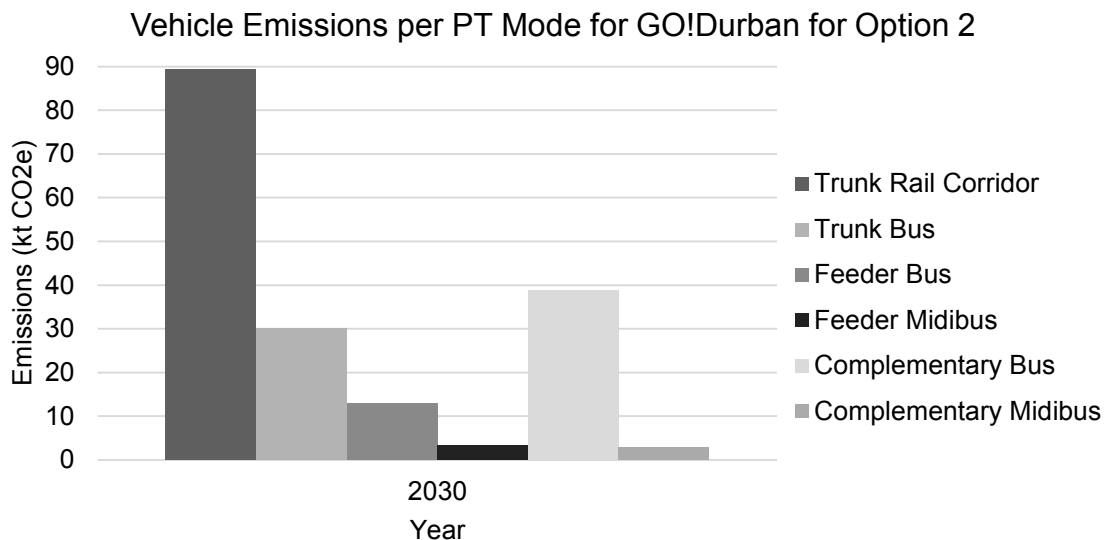

**Figure 6-7: 2030 Emissions per Vehicle Category for Option 2 of the *GO!Durban* Scenario**

In 2030 *GO!Durban* vehicle emissions total 177 228 t CO<sub>2</sub>e. Assuming that Eskom meets the CF target in 2030 (Eskom Holdings Limited, 2011), the rail corridor emits 50% of total GHGs. Approximately 103 kt CO<sub>2</sub>e in 2030 are produced by buses, owing to the allocation of the eight BRT trunk routes to articulated buses, and feeder and complementary routes to standard buses and midibuses. Together midibus emissions (6 kt CO<sub>2</sub>e) and passenger rail emissions (17 kt CO<sub>2</sub>e) comprise 22% of the total projected emissions of 2030.

Emissions produced by *GO!Durban* vehicles along trunk and complementary routes comprise majority (67% and 24%, respectively) of total 2030 emissions, as shown in Figure 6-7. Complementary routes are referred to as additional bus routes, hence one would expect complementary route emissions to be minor in comparison to those emitted by trunk routes with high vehicle frequencies. This, however, indicates the importance for transportation along many other routes which have been included as a Quality Bus Service in *GO!Durban*. Feeder route emissions equate to 13% of trunk emissions, fulfilling their purpose of efficient assistant services.

### 6.3.3 Option 3

The total emissions for 2030, for the *GO!Durban* network consisting of Euro V vehicle technology, are displayed in Figure 6-8.

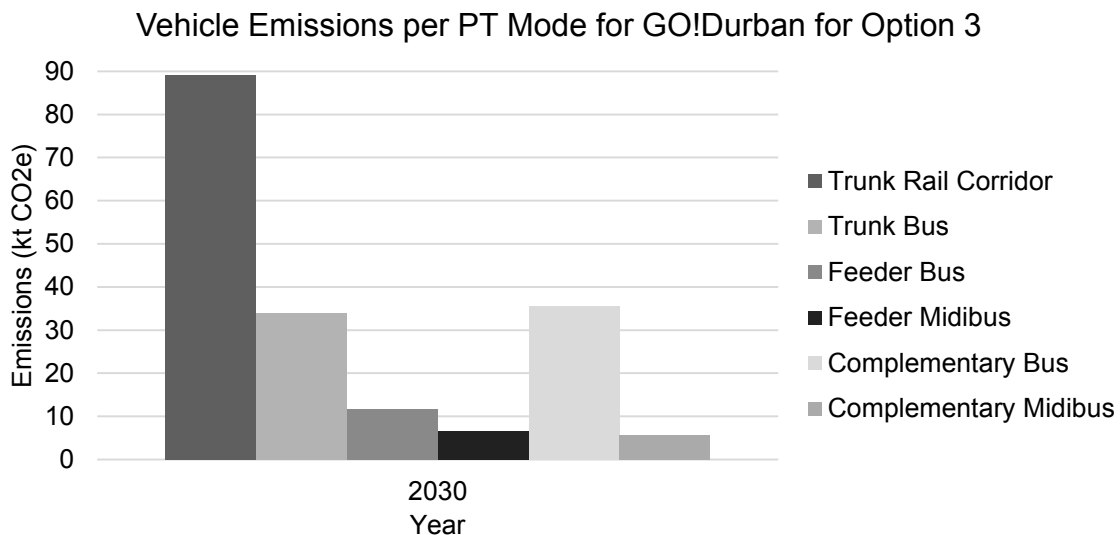

**Figure 6-8: 2030 Emissions per Vehicle Category for Option 3 of the *GO!Durban* Scenario**

182 594 t CO<sub>2</sub>e is produced by *GO!Durban* in 2030. The total GHG emissions comprise 49% passenger rail, 19% articulated bus, 25% standard bus and 7% midibus emissions. Trunk routes produce 123 kt CO<sub>2</sub>e (68% of the total) along the 190km reserved road length and rail routes, due to the priority and high frequency of vehicles. In addition, the complementary

service emits 41 kt CO<sub>2</sub>e (22% of the total) due to extensive bus routes, and assistance by feeders, 18 kt CO<sub>2</sub>e (remaining 10%).

51% of 2030 emissions are produced by road vehicles which provide services to the remaining 60% of PT passengers, proving to be the more efficient mode.

### 6.3.4 Emissions Comparison

The estimated 2030 GHG emissions produced by the functional *GO!Durban* system providing PT services in the EMA are summarised in Figure 6-9.

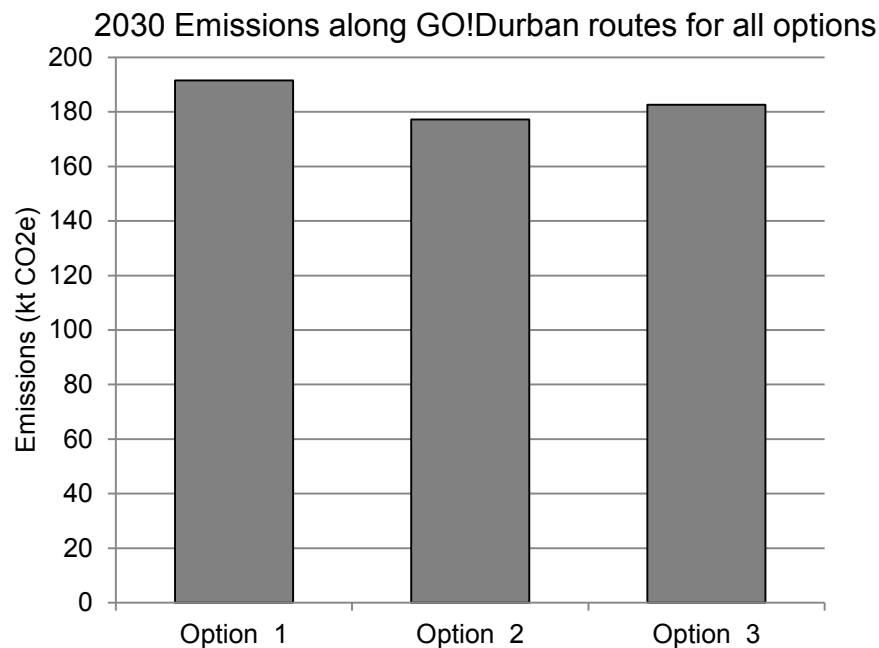

**Figure 6-9: 2030 Emissions Comparison for all Options of the *GO!Durban* Scenario**

The final 2030 emissions for Option 1, 2 and 3 are: 192 kt CO<sub>2</sub>e, 177 kt CO<sub>2</sub>e and 183 kt CO<sub>2</sub>e, respectively. Option 2 and 3 are 7% and 5% less than Option 1, respectively. These reduced emissions serve as an indication of the impact of technology advancement, which appears to be minor in 2030 however, the effect of which is considerable over several years of operation.

Option 2 which accounts for unknown vehicle upgrades, appears to be the most sustainable alternative. Option 3, however, realistically considers technology improvements according



to actual choices available. Although further developments are inevitable in the next 15 years, it is unlikely that the latest (Euro VI) technology will be procured, as existing national Euro Emission Standards in SA are Euro II regulations (Delphi, 2014/2015). Although Option 1 produces the greatest emissions, the probability of the trunk articulate buses and standard buses being similar to those chosen for this study (option) is favourable.

A detailed summary of the modal emission proportions for each option of the *GO!Durban* Scenario is provided in Table 6-1.

**Table 6-1: 2030 Emissions per Vehicle Category for the *GO!Durban* Scenario**

Route	Mode	Option 1	Option 2	Option 3
<b>Trunk</b>	Passenger Rail	47%	50%	49%
	Articulated Bus	18%	17%	19%
<b>Feeder</b>	Bus	8%	7%	6%
	Midibus	2%	2%	4%
<b>Complementary</b>	Bus	24%	22%	19%
	Midibus	2%	2%	3%

The vehicle emission proportions of all options are almost identical. The midibus proportions of Option 3 are slightly higher, due to the selection of a larger capacity vehicle adhering to higher emission standards. This has reflected as lower feeder and complementary bus emission shares. The effect of technology upgrade is apparent in Option 2 and 3 of complementary bus emissions, which are 2% and 5% less than Option 1, respectively.

Overall trunk routes produce the greatest emissions (65% – 68%), followed by complementary routes (22% – 26%) and feeders (9% – 10%). This demonstrates the core structure of *GO!Durban*, the feature of the Quality Bus Service and assistance by feeders. There is a noticeable variance of the rail trunk and complementary bus routes, with emission proportions of the latter being higher for Option 1 and 2. Trunk routes transport a significant number of passengers along concentrated corridors, however, complementary routes consist of numerous shorter routes with reduced patronage which may require smaller vehicles. This scenario considers the worst case of articulated (large) buses for trunk routes and standard (medium-sized) buses for complementary and feeder routes, resulting in the

maximum emissions for *GO!Durban*. The results indicate that travel by road transportation produces less GHG emissions in comparison to trains. There is a sizable difference between the eight BRT trunk routes and single rail corridor of 29% – 33% across all options, indicating that articulate buses are the environmental preference. The required road reserve of the designated bus lanes, in addition to escalating mixed traffic on other lanes, however, contribute to the feasibility of faster, safer and more convenient travel by passenger rail.

#### 6.4 Comparison of BAU and *GO!Durban* Scenarios

The contrast in total emissions resulting from the existing PT system and the IRPTN to be implemented is presented in this section, with consideration of vehicle assignment to individual routes for all options. The emissions produced by the BAU Scenario are shown from 2008 and although the operation of the implemented corridors of *GO!Durban* begins in 2016 (EM, 2015a), due to modeling constraints, potential emission reductions could not be measured from this point and instead comparison of the entire network in 2030 was conducted.

##### 6.4.1 Option 1

The comparison of the total emissions for both scenarios with the usage of unchanged fleet composition throughout the projection is shown in Figure 6-10.

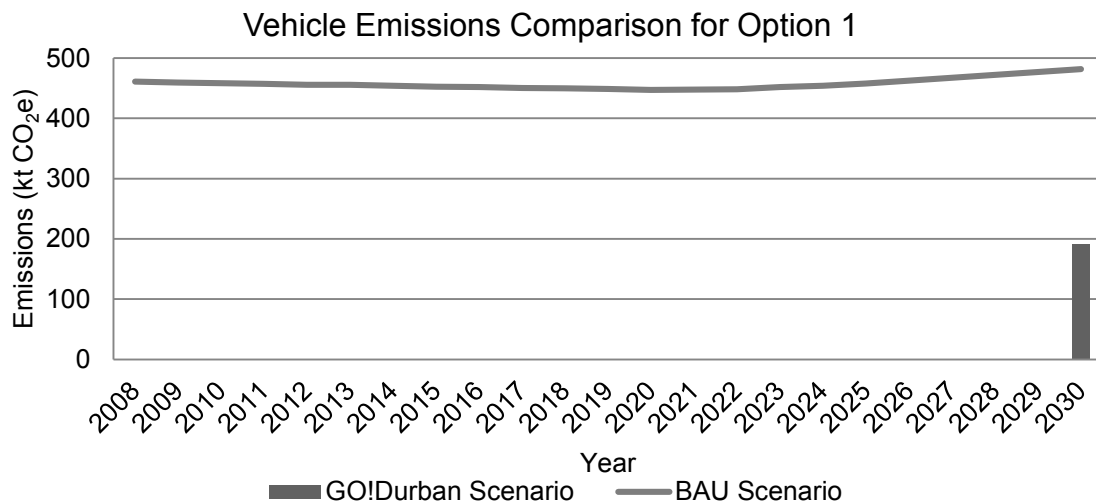

**Figure 6-10: Vehicle Emissions Scenario Comparison for Option 1**

The total 2008 BAU Scenario emissions of 462 kt CO<sub>2</sub>e gradually decrease to 2020 at an average of 1 kt CO<sub>2</sub>e per year and then rapidly increase to 482 kt CO<sub>2</sub>e in 2030. The total *GO!Durban* emissions at full implementation in 2030, as shown in Figure 6-10 are 192 kt CO<sub>2</sub>e. The impact of *GO!Durban* is particularly significant in this projection, due to the exacerbated emissions of the BAU Scenario in 2030, which are more than double the anticipated *GO!Durban* emissions. The introduction of an improved PT fleet and 60% decrease in forecast GHG emissions is motivation for the shift to *GO!Durban*

With diverging emissions, an assessment of the contribution of each mode to total 2030 emissions is important. Figure 6-11 summarises and compares the emissions split for each scenario.

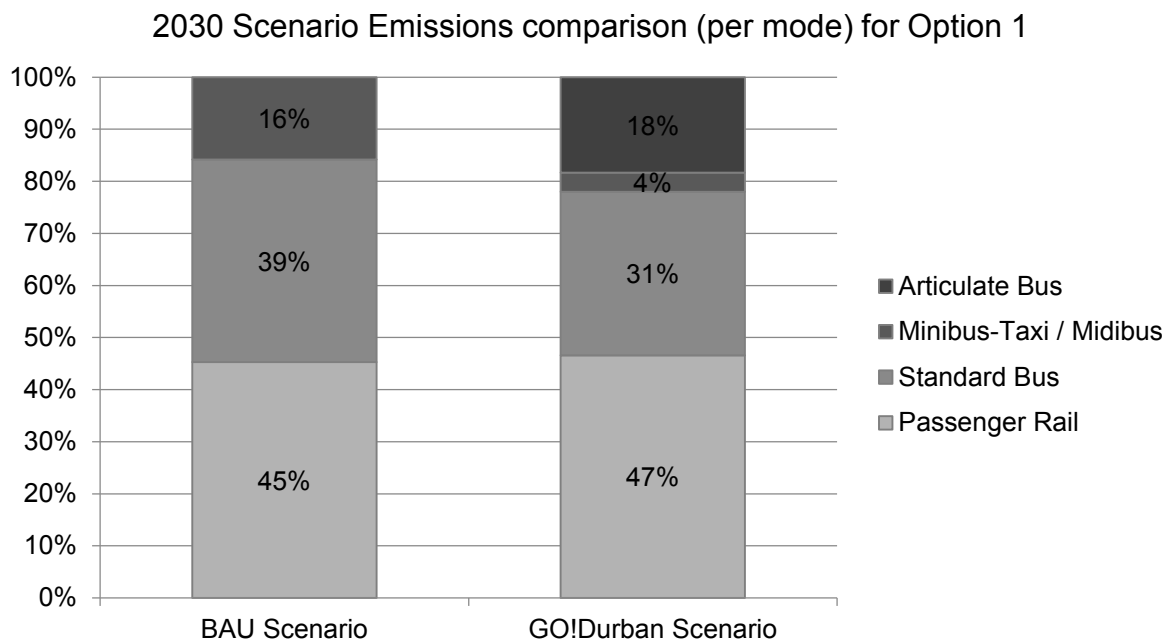

**Figure 6-11: 2030 Emission Scenario Comparison per Vehicle Category for Option 1**

As shown in Figure 6-11, both scenarios comprise almost the same percentage of passenger rail emissions. *GO!Durban* has a 50/50 split between (articulated and standard) bus and, midibus and rail corridor emissions. The shift to eight BRT trunk routes and a complementary bus system has resulted in higher proportions of bus emissions for *GO!Durban* and the reduction in midibus routes (limited feeder and complementaries) has diminished midibus emissions. The rail corridor of *GO!Durban* is anticipated to provide

services to 40% of eThekweni's PT demand, therefore the significant proportion of rail emissions are warranted. The BAU Scenario has a 55:45 split between road vehicle and railway service emissions.

Despite the increased capacity of other modes, the midibus and minibus produced the lowest emissions for both scenarios. The shares of bus emissions (for both scenarios) vary by 11%, due to the design of the system and dominance of bus routes in *GO!Durban*. The segments of midibus and rail corridor emissions differ by 29% for the BAU Scenario and 42% *GO!Durban*, respectively. In 2030 *GO!Durban* road vehicles produce 54% of emissions, comparable to the 55% of the BAU Scenario. Although new rolling stock is assigned to the rail services of *GO!Durban*, passenger rail emissions of the BAU Scenario are almost equal, reiterating the structure of *GO!Durban* and efficiency of the bus services in comparison to BAU functions.

#### 6.4.2 Option 2

The line graph in Figure 6-12 illustrates the emissions of the BAU Scenario from 2008 to 2030, in comparison to the emissions produced by the *GO!Durban* Scenario in 2030.

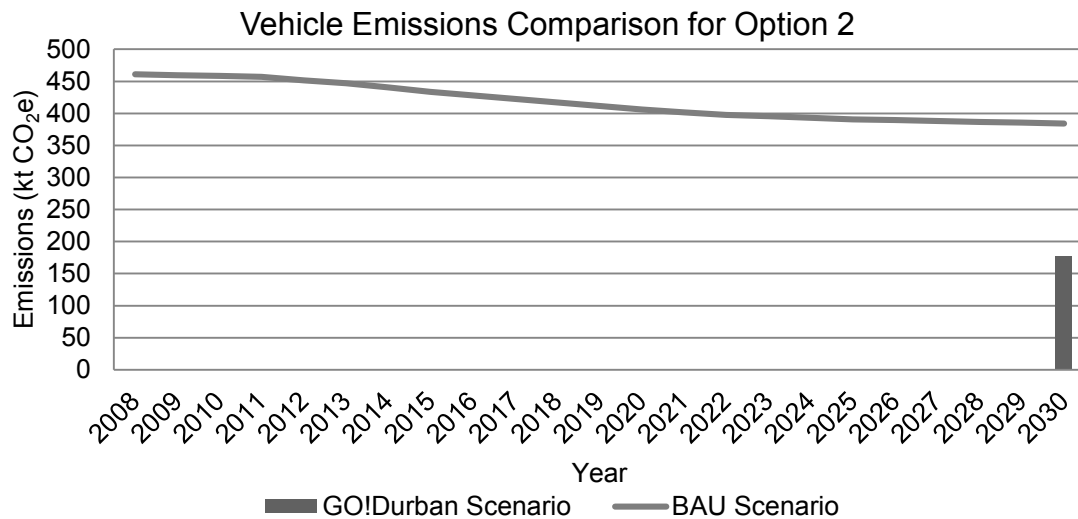
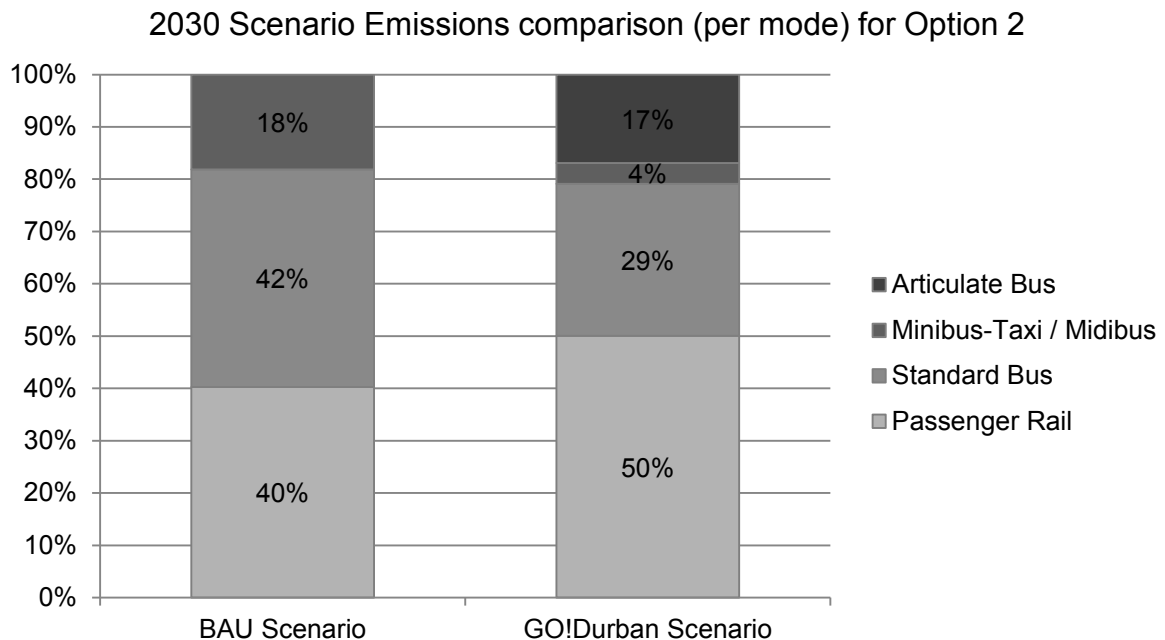

**Figure 6-12: Vehicle Emissions Scenario Comparison for Option 2**

Emissions produced by vehicles of the BAU Scenario display an overall 17% decline from 461 kt CO<sub>2</sub>e in 2008 to 384 kt CO<sub>2</sub>e in 2030. Emissions of *GO!Durban*, however, increase

with the implementation of phases to 178 kt CO<sub>2</sub>e in 2030 at full operation. The difference between the total projection of the BAU Scenario and that of the *GO!Durban* Scenario in 2030 is 206 kt CO<sub>2</sub>e, as shown in Figure 6-12. This represents a 54% decrease compared to BAU Scenario emissions, demonstrating the impact of *GO!Durban* as a revolutionary system with the ability to reduce GHG emissions by 2030. This measurement serves as an indication of the transformation brought about by the successful implementation of *GO!Durban* in the EMA.

The modal source of emissions for the 2030 projections of the BAU and *GO!Durban* Scenarios are displayed in Figure 6-13.



**Figure 6-13: 2030 Emission Scenario Comparison per Vehicle Category for Option 2**

Although total scenario emissions differ by 54% in 2030, the similarities in vehicle modes responsible were summarised in Figure 6-13. Emissions produced by buses dominate the BAU Scenario (at 42%), followed by passenger rail (40%) and the minibus-taxi industry (18%). For *GO!Durban* however, the passenger rail services release 50% of total emissions, with bus emissions almost equal (46%) and minor midibus emissions (4%). The percentage of bus emissions is similar for both scenarios, owing to the reliance on bus routes of *GO!Durban* and the inefficient bus service in the BAU Scenario.

For the BAU Scenario, passenger rail comprises 42% of total P-kms for 2030, releasing a corresponding 40% of total GHG emissions. Although bus-kms are 65% less than total distances driven by minibus-taxis in the BAU scenario, emissions from buses are more than double produced by minibus-taxi services. The eight BRT routes and services (road vehicles) in *GO!Durban* produce 50% of *GO!Durban* emissions. Rail trips with high volumes on one direction during the peak periods, may have many empty coaches on return trips, thereby producing high emissions. Owing to minimum route assignment to midibuses in *GO!Durban*, they comprise a mere 4% of total 2030 emissions and 6% of road vehicle emissions.

### 6.4.3 Option 3

The comparison of GHG emissions produced by the BAU Scenario and *GO!Durban* according to the most advanced technology possibilities of vehicles, is displayed in Figure 6-14.

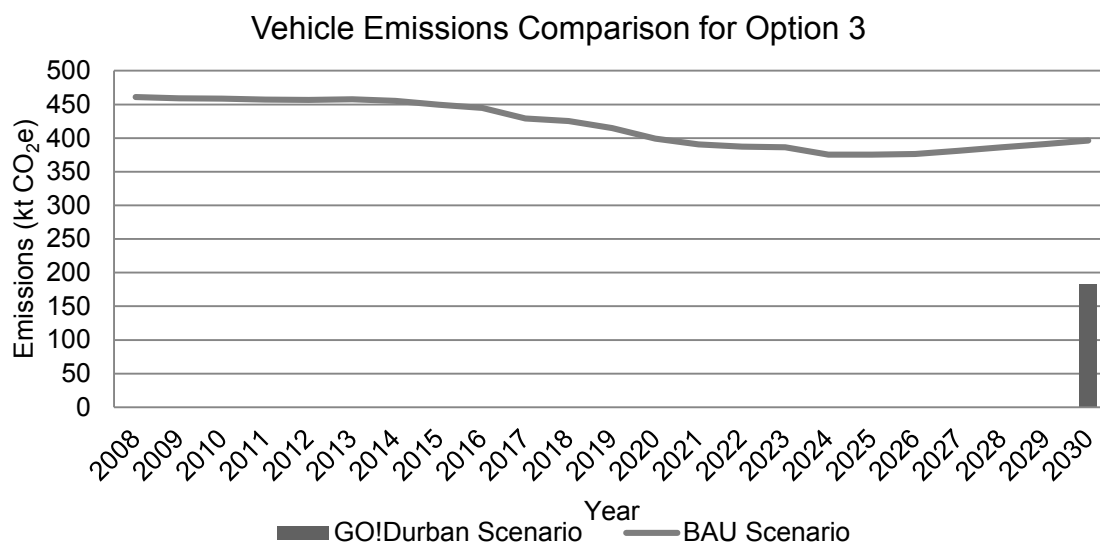
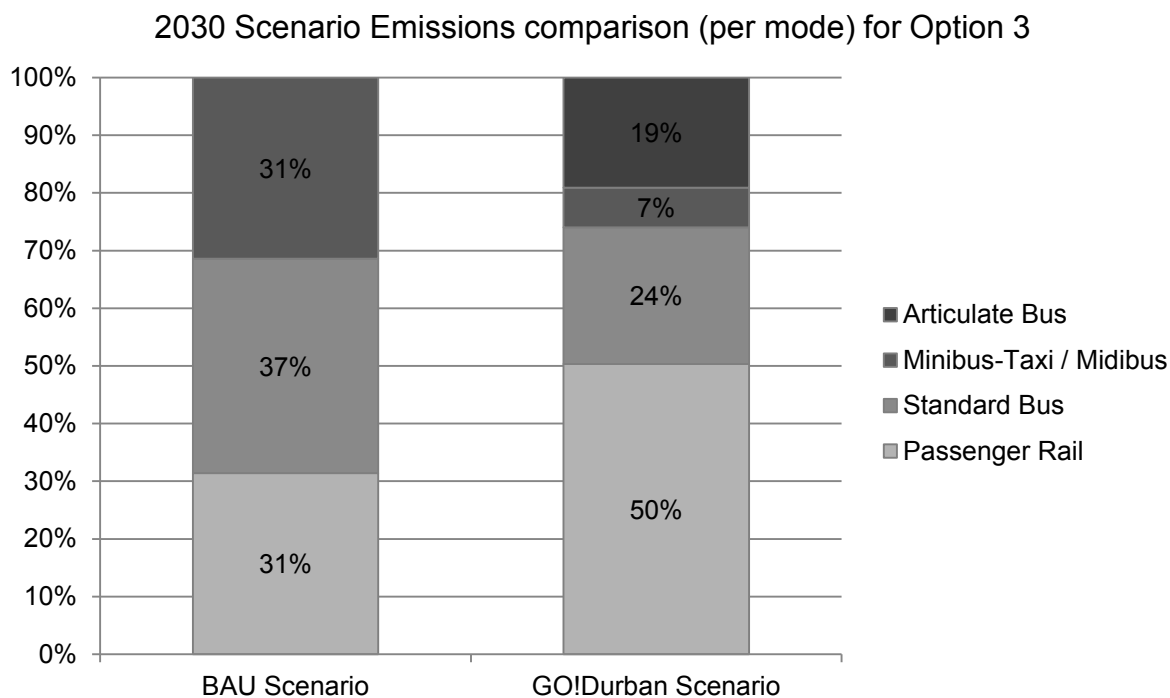

**Figure 6-14: Vehicle Emissions Scenario Comparison for Option 3**

The emission profile of the BAU Scenario displays a staggered trend at the introduction of new vehicle technology to 397 kt CO<sub>2</sub>e in 2030. An average 6% annual decrease in passenger rail emissions is expected during the gradual implementation of the new rail rolling stock, a considerable contribution to the overall deficit. *GO!Durban* produces 183 kt

CO<sub>2</sub>e in 2030, 54% less than emissions of the BAU Scenario. Even with the latest available vehicle technology, the emissions of the BAU Scenario are immensely greater than *GO!Durban*, emphasizing the limitations of the system and requirement for a transformation.

The compositions of emissions for each scenario are displayed in Figure 6-15.



**Figure 6-15: 2030 Emission Scenario Comparison per Vehicle Category for Option 3**

For the BAU Scenario, buses produce the most emissions, followed by minibus-taxis and the rail service. The emissions of road vehicles dominate the BAU Scenario, comprising 68%, owing to the emission savings brought about by the new X'Trapolis Mega assigned to the rail services. Although in *GO!Durban*, rail emissions are the highest (with the bus segment 5% less) and midibus emissions comprising a mere 7%. Considering that the same vehicle has been selected for both scenarios, the 24% difference in midibus and minibus emission segments demonstrates the impact of route assignment and dependence on the mode in the BAU Scenario. The bus and passenger rail segments in the *GO!Durban* Scenario are comparable, considering the majority of bus routes and the provision of services to 40% of the EMA's PT passengers by the rail corridor. Despite annual midibus

distances being almost 60% of total bus distances, minibuses emit 85% less GHGs than buses.

#### 6.4.4 Scenario Comparison

The projected emissions for both the BAU Scenario and *GO!Durban* vary depending on the availability and selection of vehicle technology. *GO!Durban* creates an opportunity to reduce the emissions of the PT system within the EMA, for which the total 2030 estimations (with both scenarios operating as individual entities) are comparable. Potential emission alleviation for each option is shown in Figure 6-16.

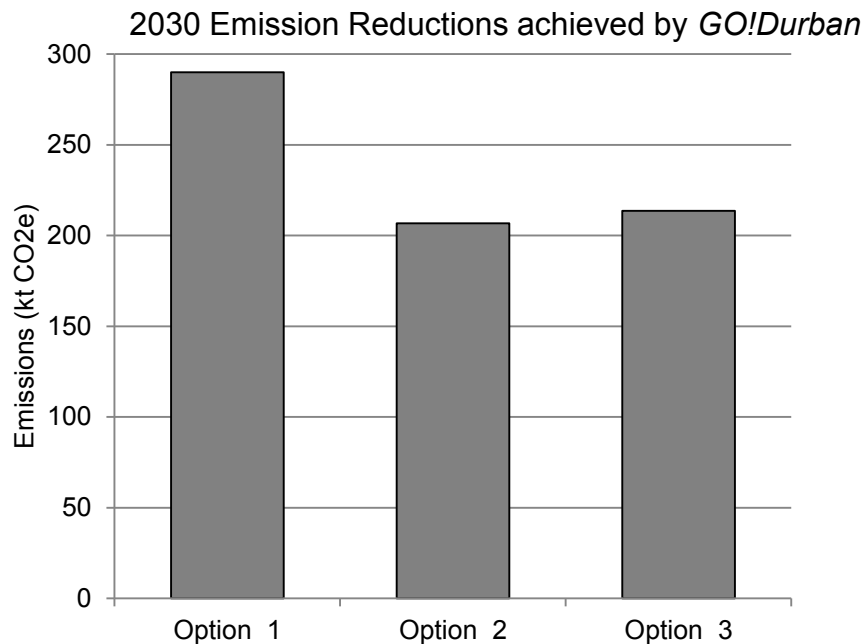

**Figure 6-16: 2030 Estimated Emission Reductions for all Options**

The emission differences between the BAU Scenario and *GO!Durban*, as displayed in Figure 6-16 for the year 2030, range from 207 kt CO<sub>2</sub>e to 290 kt CO<sub>2</sub>e. These significant emission improvements brought about by the launch of *GO!Durban* would diminish the GHG emission of the PT sector of the EMA by 54% to 60%. This would reduce emissions of the transportation sector on the whole. Therefore, all IRPTN advancements and associated GHG mitigation would be extensive on a municipal and national level. In 2030, approximately 150 000 kt CO<sub>2</sub>e is expected to be emitted by transport sector nationally,



under the 'growth without constraints' scenario in Section 2.2.4 (Scenario Building Team, 2007). A reduction of GHG emissions of 290 kt CO<sub>2</sub>e in 2030, resulting from the implementation of *GO!Durban*, will reflect as a 0.19% decrease in the total emissions of transport sector in SA. This may seem minor, however, in addition with the other IRPTNS and mitigation strategies in PT and the transport sector on the whole, will have a significant impact on emissions and the environmental impact of transportation in SA.

Option 1 indicates the highest reductions in emissions, due to the presence of formal and informal operations of the BAU Scenario. For Option 1, owing to the outdated PRASA rolling stock and unsustainable electricity generation, the greatest emission reductions are measured along passenger rail routes. Option 2 displays a smaller, still significant, drop in passenger rail emissions due to the consideration of the Eskom objectives in the BAU Scenario. In Option 3, the assignment of the *X'Trapolis Mega* to both scenarios results in a smaller decrease in rail emissions and the introduction of latest bus technology has decreased emissions in the BAU Scenario.

Specific vehicles will be assigned to *GO!Durban* routes, thereby serving different functions compared to the BAU Scenario. Buses in the *GO!Durban* Scenario are classified as articulate and standard buses based on capacity and route assignment, whereas only standard buses operate in the BAU Scenario, resulting in intermediate reductions due to the extent of bus routes in *GO!Durban*. Even so, improvements in bus emissions comprise a consistent decline in emissions across all options.

The implementation process, which involves the simultaneous phasing-out of the existing PT services and phasing-in of the *GO!Durban* system, may prove challenging. Assuming it is successful, however, in terms of GHG mitigation, the end result of all options motivates the shift towards *GO!Durban*. As mentioned in Section 3.2.4, the leapfrog approach has been adopted by government for the shift towards *GO!Durban*. Considering the phased approach of *GO!Durban*, in which Phase One (C1-C4) is introduced and the corresponding existing PT services are terminated, significant emission reductions will be achieved at the end of each corridor, and progress with each phase. Figure 6-17 provides an emission profile for the *GO!Durban* system and the BAU Scenario according to the phased (leapfrog) approach specified in Section 3.2.4.

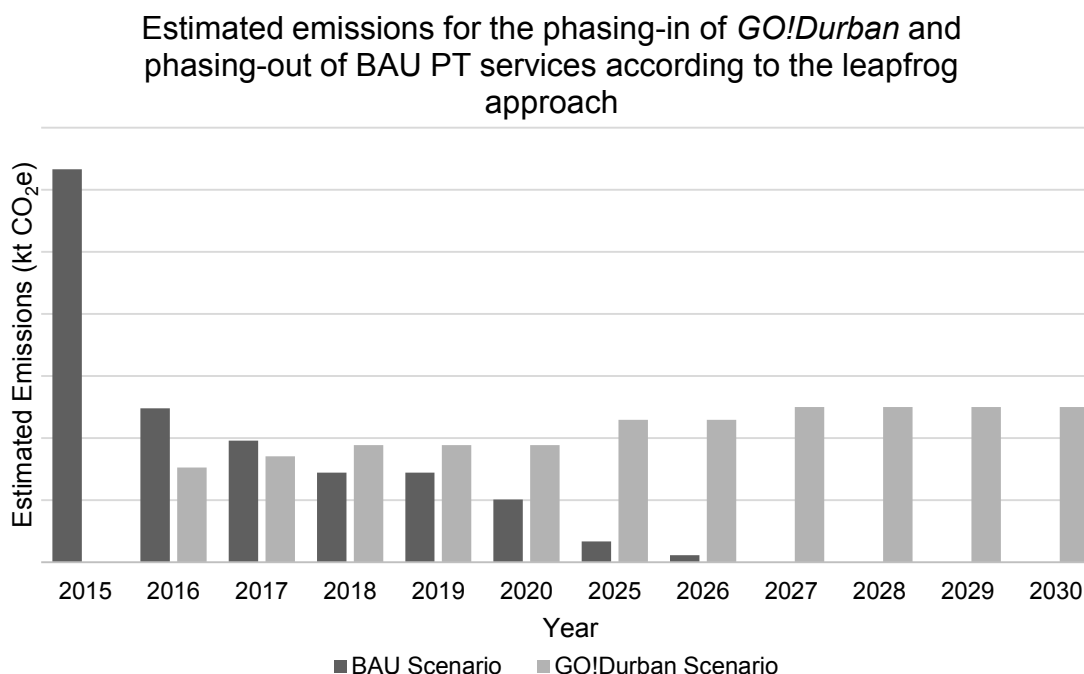

**Figure 6-17: Emissions Profile for the Phasing-in of *GO!Durban* and Phasing-out of existing PT services**

As anticipated, the operational emissions of the BAU Scenario decrease with the termination of existing PT services and the emissions of *GO!Durban* increase until the completion of the system. The overall annual emissions of all PT services in the EMA is determined by the components of both systems, which exist at specific times during implementation. The cumulative emission reduction achieved during the implementation process is dependent on the procedure followed. Figure 6-18 provides an overview of the total emissions per year according to the introduction of phases for the leapfrog approach.

An alternate approach, however, would produce a different result. The environmental impact of an approach, similar to the development of the *Rede Integrada de Transporte* in Curitiba, which introduces steady improvements across all PT services in the EMA, must be considered. Incrementalism will produce small reductions in operational GHG emissions for various stages of advancement. Therefore, it is important to note that the annual reductions achieved at each level of improvement will accumulate over the duration of implementation, and may exceed those reflected by leapfrogging.

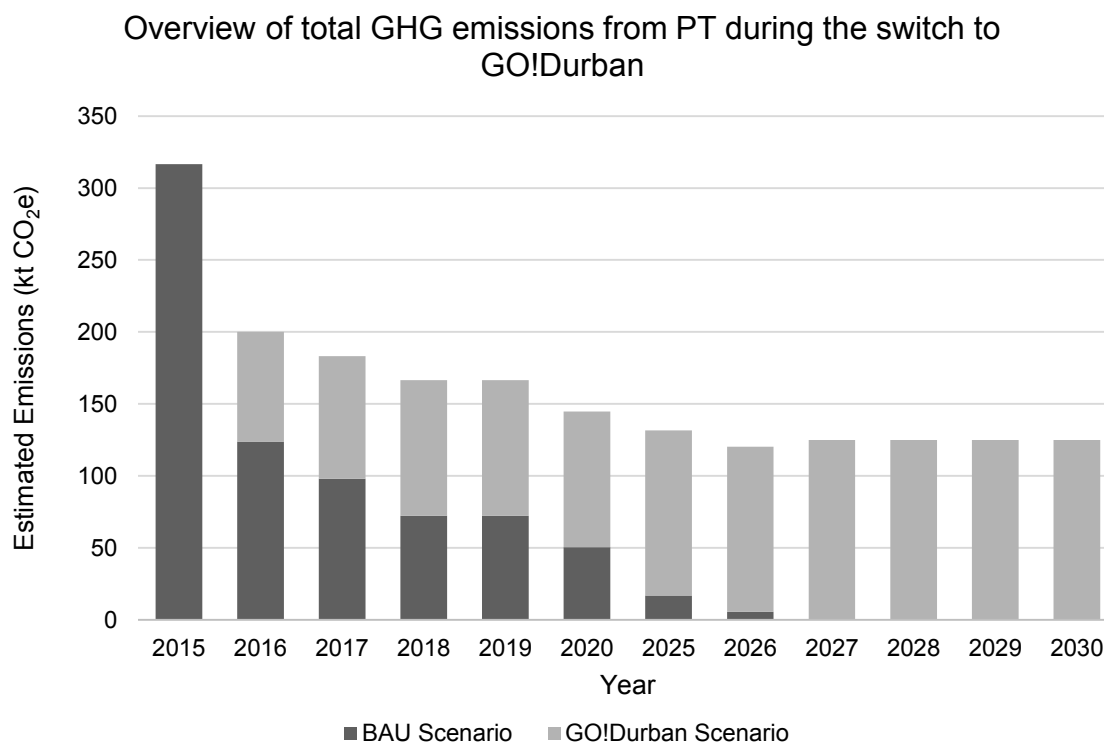

**Figure 6-18: Overview of Total Emissions of the PT Sector during the shift to *GO!Durban***

The overall emissions are shown to decrease rapidly with the implementation of phases to 2030. The results in this chapter present the ultimate emissions of the wall-to-wall network for the year of 2030, in comparison to the BAU Scenario, had the existing PT system continued to the year 2030. Although the implementation approach adopted will not alter the emission reduction achieved for the year of 2030, the procedure will determine the total emissions mitigated.

## 6.5 Sensitivity Analysis

This section presents the sensitivity to two parameters, namely fuel consumption and annual distance driven by PT vehicles. The BAU and *GO!Durban* Scenarios were considered independently to investigate the individual impact on the overall GHG reductions in the year 2030. The results for the energy consumption for the BAU Scenario displayed in Table 6-2.

**Table 6-2: Sensitivity to 5% and 10% variance in fuel consumption parameters for the BAU Scenario**

Vehicle Category	Option 1		Option 2		Option 3	
	5%	10%	5%	10%	5%	10%
<b>Bus</b>	3%	6%	4%	8%	3%	7%
<b>Minibus-taxi</b>	1%	3%	2%	3%	3%	6%
<b>Train</b>	4%	8%	4%	7%	3%	6%

The results of this study are not sensitive to the energy consumption of the BAU fleet. As shown in Table 6-2, for technology Option 1 the rolling stock energy requirement has the greatest effect on the final results of this study, due to the efficiency of the trains. For Option 2 and 3, an adjustment to bus fuel consumption presents the largest influence, as the energy efficiency of trains is improved.

The sensitivity to the energy requirement of the vehicles operational in the *GO!Durban* system is shown in Table 6-3.

**Table 6-3: Sensitivity to 5% and 10% variance in fuel consumption parameters for the GO!Durban Scenario**

Vehicle Category	Option 1		Option 2		Option 3	
	5%	10%	5%	10%	5%	10%
<b>Articulate Bus</b>	1%	1%	1%	1%	1%	2%
<b>Standard bus</b>	1%	2%	1%	3%	1%	2%
<b>Midibus</b>	0%	0%	0%	0%	0%	1%
<b>Train</b>	2%	3%	2%	4%	2%	4%

The variance in fuel consumption data for *GO!Durban* vehicles has almost no effect on the overall achievable GHG emission reductions measured. Changes in the electricity consumption of rail, the most energy intensive PT mode, has the highest influence on *GO!Durban* emissions. There is no sensitivity towards bus parameters and midibus proportions are negligible.

The relationship of increasing variability of total distance travelled by all PT vehicles for each system is shown in Figure 6-19.

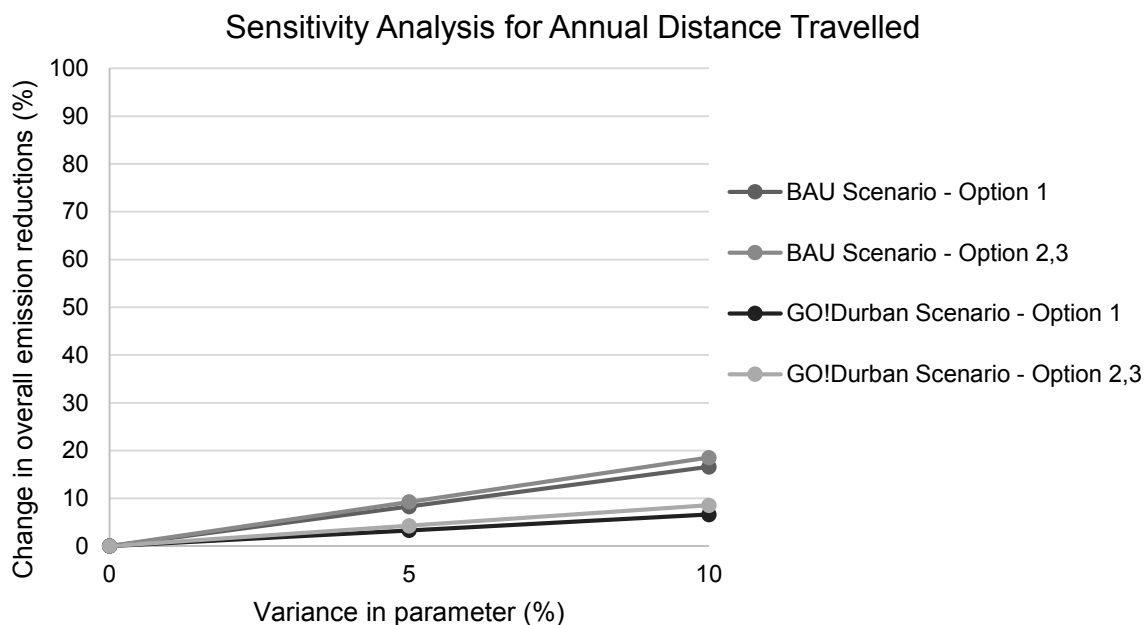

**Figure 6-19: Sensitivity to Distance Driven by BAU and *GO!Durban* Scenario Vehicles**

The sensitivity indicated by Figure 6-19, 17% -19% for a 10% change in parameter for the BAU Scenario and 7% - 9% for *GO!Durban* respectively, is acceptable for this study. Variance in *GO!Durban* vehicle-kms has a smaller influence due to the more efficient vehicle technology. As emissions for Option 1 are higher, a variation is reflected on a smaller scale and a lower impact is seen in comparison to the reduced emissions of Option 2 and 3. As demonstrated, an adjustment in the distance driven by PT vehicles is directly proportional to emissions produced and will directly influence the results of this study. Limitations and uncertainties for the projections used in this study have been noted in Chapter 4, and the vehicle operating schedules may change for each phase of *GO!Durban* implemented.

## 6.6 Comparison with *Rea Vaya* Carbon Credits Study

A carbon credits study was conducted by Grütter (2011) in accordance with CDM methodology AM0031 Version 03.1.0 (CDM, 2011) for Phase 1A and 1B of the *Rea Vaya* BRT system. The study served as a calculation of the GHG emission reductions of the

Baseline (BAU) and Project Scenarios in the PT sector for the City of Johannesburg, and also considered leakage emissions resulting from reduced congestion and increased speeds. The Baseline Scenario assumes the continuation PT services, and considers the passengers that would have used PT in absence of *Rea Vaya*. The *Rea Vaya* BRT comprises two ROW bus routes and a complementary and feeder system. Emission monitoring (which measured CO<sub>2</sub>, CH<sub>4</sub> and N<sub>2</sub>O), began with the operation of Phase 1A on 30 August 2009. The Project (BRT) Scenario is based on actual fuel consumption from *Rea Vaya* buses for Phase 1A and projections carried out for Phase 1B. (Grütter, 2011).

The results show the Baseline emissions at 60 kt CO<sub>2</sub> e (2012) decreasing to 55 kt CO<sub>2</sub> e (2021) due to applicable technology improvements. Project emissions remain constant (for the same system and scheduled services) at 18 CO<sub>2</sub> e, representing a 69% decrease in GHG emissions. A total GHG reduction of 398 kt CO<sub>2</sub>e is achieved over 10 years by the implementation of *Rea Vaya*, at an average 37 kt CO<sub>2</sub>e per year (Grütter, 2011).

The GHG emission reductions of *GO!Durban* (ex-ante) and *Rea Vaya* (monitored) display a similar trend of an achievable maximum of 60% and a 69%, respectively. The Project Scenario of Phase 1A and 1B of *Rea Vaya* does not include emissions from Metrorail, the Gautrain or other PT services in the City of Johannesburg, it only considers a fraction of services in the municipality. In contrast, *GO!Durban*, is an extensive IRPTN spanning nine corridors across four phases, with corridor consisting of the entire PRASA service. This study calculated the emissions of the PT sector for the EM on the whole for three technology scenarios.

The similarity in results serve as an indication of the achievable success of *GO!Durban*. Although on a smaller scale, the transformation realised by *Rea Vaya* validates the results of this dissertation and the potential of *GO!Durban* on a greater scale.

## **6.7 Summary**

The results presented in this chapter were generated in accordance with the methodology presented in Chapter 4. In 2030, the total GHG emission reductions brought about by the implementation of *GO!Durban*, in comparison to the BAU Scenario range between 207 kt CO<sub>2</sub>e and 290 kt CO<sub>2</sub>e, for varying vehicle technology options. Overall a maximum reduction

of 60% of GHG emissions is achievable in 2030 by the introduction of *GO!Durban* and termination of existing PT services (BAU Scenario).

GHG emissions generation was not sensitive to the vehicle category and model chosen. The role of vehicles has clearly been defined in *GO!Durban*, in vehicle assignment to routes. As expected, these differ from the existing PT system and provide a transformational IRPTN in the EMA. The *X'Trapolis Mega* rolling stock was selected and procured for *GO!Durban*, however, considerable assumptions were required with regard to vehicle choice of buses. For the purpose of this study, the vehicles selected for *GO!Durban*, comprise buses operating in *Rea Vaya* and *MyCiTi*, therefore, the probability of procurement for *GO!Durban* is favourable. The advice provided by *Volvo* and consultation with *Piotrans* was informative.

The major GHG contributor in the BAU Scenario is the outdated rolling stock used by PRASA, which if upgraded alone would reduce emissions significantly. While Option 1 indicates the most emission reductions, the possibility of technology advancement in the BAU Scenario has not been explored in this option. Option 2 explores the development of vehicle technology up to 2030, for which considerable GHG reductions are observed in the BAU Scenario. For Option 3, the vehicles being manufactured for *MyCiTi* were selected and although, it is unlikely that Euro V Standard vehicles will be procured for the starting phases of *GO!Durban* (considering SA's current Euro II Emission Standard regulations), it serves as an accurate estimate for 2030. Although midibuses require a greater road reserve due to reduced passenger capacity, it has been shown that this vehicle category produces the least emissions over all projections. The sustainability goals of Eskom to be achieved in electricity generation have been included in this study, however, with transmission and distribution losses at 10%, it is unclear whether Eskom will meet their targets to reduce CO<sub>2</sub> emissions by 2030.

This study does not include POVs, however, the emissions released due to anticipated modal shifts and higher ridership of PT have been covered in the TMS projection. As the modal shift towards PT increases, so too does the opportunity to improve overall transportation emissions. Although a 20% shift to PT is explored in the *GO!Durban* Scenario, the overall operational emissions of the system are significantly lower than BAU, demonstrating the definite benefit of the system. Park and ride facilities enable a POV to park at the stations and switch to PT (where people would have before travelled in POVs,

many with vehicle occupancy of one) for continuation of the trip in a *GO!Durban* vehicle. Although the usage of NMT has not been measured, the significant increase in NMT facilities as a component of *GO!Durban* promotes walking and cycling, which will further contribute to emissions reductions.

The results of the carbon credits study conducted on Phase 1A and 1B of *Rea Vaya* demonstrate the success that has already been accomplished in the City of Johannesburg. The 69% reduction in GHG emissions caused by the introduction of the BRT system is comparable with the 60% for *GO!Durban* measured by this study, and serves as a positive indication of the achievable GHG decrease of *GO!Durban*, on a significantly larger scale. These GHG mitigation schemes, in conjunction with *MyCiTi* and others nationally, have successfully contributed to reducing the environmental impact of PT.

Similar to the cumulative savings achieved for *Rea Vaya*, the total emission reductions achieved over the duration of implementation will be determined by the approach selected. Although a leapfrog approach has been adopted for *GO!Durban*, it is important to note that an incremental approach may result in the mitigation of greater GHG emissions during the shift to *GO!Durban*, therefore a less significant environmental impact.

The gradual phasing-in of the IRPTN corridors and simultaneous phasing-out of the existing minibus-taxis and buses is crucial for the success of the network. Concurrent systems will result in greater emissions and competitive services will reduce patronage of *GO!Durban*. The case of unsynchronised phasing programmes (the event of trunk routes coming online without appropriate feeder and complementary routes, etc.) would result in altered emissions, which have not been included in this study. It must be considered that the introduction of a revolutionary network may have a rebound effect and in reducing the number of minibus-taxis on the road, may in fact make POV usage appear more attractive. Chapter 2 has explored options enforced in other countries to promote PT usage, which may be considered for the EM as well.



---

## CHAPTER 7

### CONCLUSIONS

The inefficient PT services offered in the EMA have prompted the implementation of an IRPTN. *GO!Durban* containing eight BRT and one rail trunk route, feeders and complementary routes will introduce a formalised PT system, for the provision of services in the municipality. This study quantifies the current and potential GHG emissions in the PT sector of the EMA by ex-ante GHG emission comparisons of the BAU Scenario and *GO!Durban*. There is a shortage of carbon studies in the EMA and scenario analyses in particular, which motivated this study.

To satisfy the aims and objectives of this dissertation, theoretical and case study approaches were adopted. *Clean Development Mechanism (CDM) AM0031 Large-scale Methodology: Bus rapid transit projects Version 05.0.0* proved to be the most appropriate approach for the case study. Fuel and energy consumption factors, applicable in a South African context have aided in the accurate calculations of the carbon footprint of the PT sector (current and future). The low-population growth BAU Scenario follows Phase One of the PTAP (DoT RSA, 2007) and high growth projection (with stipulated modal shift of 20% towards PT) for the *GO!Durban* Scenario applies all phases of the PTAP.

The anticipated CF of vehicle operations of *GO!Durban* in 2030 are 177 kt CO<sub>2</sub>e to 192 kt CO<sub>2</sub>e for the latest Euro Emission Standard vehicle technologies. In comparison, the projected emissions of the BAU Scenario are 384 kt CO<sub>2</sub>e to 482 kt CO<sub>2</sub>e. Even with increased ridership of the *GO!Durban* Scenario (shift of 20% from POV to PT), the network still emits less GHGs. Therefore, the expected operational emissions of *GO!Durban* in 2030 will be 54% to 60% lower than projected emissions of the existing PT system (BAU Scenario), for the different vehicle technology options considered. The results of this ex-ante study are comparable to the carbon credits study conducted on the *Rea Vaya* BRT system in the City of Johannesburg, in which a 69% reduction in GHG emissions was monitored. This indicates the achievable success of *GO!Durban* on a significantly larger scale, and the accomplishment of GHG emissions in the transport sector.

In conclusion, the structure of *GO!Durban* has been determined according to travel demands of the public, therefore, the success of the system must be ensured (through various

---

measures encouraging PT usage, including disincentives for POV usage) for GHG mitigation. For the purpose of this study, the latest revision of the preliminary plans for *GO!Durban* were used, however, these may be adjusted and improved upon during implementation of the network. Considering the trunk route selection was done in accordance with maximum travel demand, in effort to effectively transport passengers along corridors, the major contributor to the operational emissions of the system is vehicle selection with respect to latest available technology. The following recommendations have been made:

- The selection of latest Euro V vehicle technology for the bus routes, with potential options including the or Volvo 6x2 B12MA (articulate bus) and Volvo B7R 8700 LE (standard bus);
- It is advisable that competent modelling of PT scenarios is conducted before the implementation of PT interventions to precisely predict and indicate the 'end product' that will be realized. Therefore the following recommendations have been made:
  - The optimum use of Emme software features, especially the environmental GHG emission component for quantification and possible comparison with other methods;
  - The use of updated spatial development (NUDC) for the EM and the inclusion of relevant future development (including Dig-Out Port) in transportation modeling for appropriate results;
  - The use of updated CPTR data that is validated and accurate in transport modelling programmes (as CPTR 2013 was not correct and CPTR 2004 has to be used); and
  - The investigation of the various stages of implementation to evaluate the most appropriate path (order) to be followed.
- Further studies investigating and evaluating incrementalism and leapfrogging for the implementation of BRT and *GO!Durban* is advisable. The GHG emissions of each approach could assist in decisions for the most suitable way forward.

This study serves as a first-of-its-kind benchmark for the *GO!Durban* system, upon which further studies can be built. More studies on other IRPTNs to be implemented in SA are recommended as a measure of success in reducing the GHG emissions of the PT sector.

---

## REFERENCES

- AA – ALIVE ARRIVE. 2013. *Bus Rapid Transit System (BRT) and Road Safety* [Online]. Available: <http://www.arrivealive.co.za/pages.aspx?i=2874> [Accessed 20 April 2013].
- ALVINSYAH, S. & ZULKATI, A. 2005. Impact on the Existing Corridor due to Implementation of New Public Transport Corridor (Case Study: Jakarta BRT Systems). *Journal of the Eastern Asia Society for Transportation Studies*, vol. 6, pp. 467-479.
- ARRHENIUS, E. & WALTZ, T. 1990. *The Greenhouse Effect: Implications for Economic Development*, Washington DC, World Bank.
- BALDO, G., MARINO, M. & MONTANI, M. 2009. The carbon footprint measurement toolkit for the EU Ecolabel. *The International Journal of Life Cycle Assessment*, vol. 14, pp. 591–596.
- BARKER, J. 2011. *Public Transportation Improvement Program for eThekweni* [Online]. Durban: eThekweni Municipality. Available: <http://www.mile.org.za/QuickLinks/News/Documents/IRPTN%20presentation.pdf> [Accessed 22 March 2013].
- BARKER, J. 2013. Integrated Rapid Public Transport Network. *Proceedings of the 31st Southern African Transport Conference*, 8-11 July 2013, Pretoria. South Africa, pp. 1-23.
- BHOTHHA, D. 2013. *Personal Communication*. Training Service Planner, Metrorail, Passenger Rail Agency of South Africa.
- BOUTLER, P., BARLOW, T., MCCRAE, I. & LATHAM, S. 2009. *Emission Factors 2009: Final Summary Report*. Berkshire: TRL Limited.
- CAJIAO, J. 2013. *Personal Communication*. Chief Operational Officer, Piotrans, South Africa.
- CARBON TRUST. 2006. *Carbon footprints in the supply chain: the next step for business* [Online]. London. Available: <http://www.carbontrust.com/media/84932/ctc616-carbon-footprints-in-the-supply-chain.pdf> [Accessed 20 February 2013].

- 
- CHAN, S., MIRANDA-MORENO, L., ALAM, A. & HATZOPOULOU, M. 2013. Assessing the impact of bus technology on greenhouse gas emissions along a major corridor: A lifecycle analysis. *Transportation Research Part D*, vol. 20, pp. 7-11.
- CHEN, X. & WANG, Z. 2012. Low-carbon scenario analysis on urban transport of one metropolitan in China in 2020. *Journal of Industrial Engineering and Management*, vol. 5, no. 2, pp. 344-353.
- CHETTY, R. 2013. *Personal Communication*. Senior Manager, eThekweni Transport Authority, South Africa.
- CCT – CITY OF CAPE TOWN. 2013. *MyCiTi IRT: Project information* [Online]. Available: <https://www.capetown.gov.za/en/irt/Pages/default.aspx> [Accessed 22 November 2014].
- CITY OF JOHANNESBURG. 2013. *Rea Vaya: Fast Facts* [Online]. Available: <http://www.reavaya.org.za/welcome/fast-facts/144-media-releases/newsletters> [Accessed 2014 23 June].
- CITY OF JOHANNESBURG. 2014. *Rea Vaya up for Climate Leadership Award* [Online]. Available: <http://www.reavaya.org.za/news-archive/july-2014/1060-rea-vaya-up-for-climate-leadership-award> [Accessed 21 November 2014].
- CITY OF TSHWANE. 2013. *Bus Rapid Transit* [Online]. Available: <http://www.tshwane.gov.za/Services/Transport/Bus%20Rapid%20Transit/Pages/default.aspx> [Accessed 11 February 2013].
- CDM – CLEAN DEVELOPMENT MECHANISM. 2011. *Large-Scale Methodology, AM0031: Bus rapid transit projects, Version 05.0.0*. Switzerland: United Nations Framework on Climate Change.
- COHEN, J. 2008. Calming Traffic on Bogota's Killing Streets. *Science*, vol. 319, pp. 742-743.
- CORNELL UNIVERSITY. 2013. *Biofuels* [Online]. Available: <http://www.greenchoices.cornell.edu/energy/biofuels/> [Accessed 23 May 2014].
- COX, P. 2010. *Moving People: Sustainable Transport Development*, London, Zed Books.
-

- 
- CROZET, Y. & LOPEZ-RUIZ, H.G. 2013. Macromotives and microbehaviours: Climate change constraints and passenger mobility scenarios for France. *Transport Policy*, vol. 29, pp. 294–302.
- CUENOT, F., FULTON, L. & STAUB, J. 2012. The prospect for modal shifts in passenger transport worldwide and impacts on energy use and CO<sub>2</sub>. *Energy Policy*, vol. 41, pp. 98-106.
- DMA – DAVID MCFARLANE AND ASSOCIATES. 2008. *Prediction of Vehicle Emissions for eThekweni Municipality using Emme 2*. eThekweni: eThekweni Municipality.
- DE JONG, R., AHMAN, M., JACOBS, R. & DUMITRESCU, E. 2009. *Hybrid Electric Vehicles: An overview of current technology and its application in developing and transitional countries*. Nairobi: United Nations Environment Programme.
- DELPHI. 2014/2015. *Worldwide Emission Standards Passenger Cars and Light Duty Vehicles* [Online]. Available: <http://delphi.com/docs/default-source/old-delphi-files/87b5fc76-3bbf-4568-a051-c83d1e4ad9a3-pdf.pdf?sfvrsn=1> [Accessed 5 August 2014].
- DBIS – DEPARTMENT FOR BUSINESS INNOVATION AND SKILLS. 2011. *Publicly Available Specification 2050:2011*. London: Department for Business, Innovation and Skills.
- DEA – DEPARTMENT OF ENVIRONMENTAL AFFAIRS. 2009. *State of Air Report 2005*, Republic of South Africa.
- DoT RSA – DEPARTMENT OF TRANSPORT REPUBLIC OF SOUTH AFRICA. 2007. *Public Transport Action Plan* [Online]. Available: [http://www.cityenergy.org.za/uploads/resource\\_192.pdf](http://www.cityenergy.org.za/uploads/resource_192.pdf) [Accessed 5 May 2014].
- DoT RSA – DEPARTMENT OF TRANSPORT REPUBLIC OF SOUTH AFRICA. 2010. *National Transport Master Plan NATMAP 2050: National Report Executive Summary*.
- DoT RSA – DEPARTMENT OF TRANSPORT REPUBLIC OF SOUTH AFRICA. 2011. *A Guide to Low-Carbon Transport – Transportation, Climate Change and the UN*
-

- 
- Framework Convention on Climate Change, Report prepared for the 17<sup>th</sup> Conference of Parties (COP17) in Durban 2011*, [Online]. Available: [http://www.cityenergy.org.za/uploads/resource\\_217.pdf](http://www.cityenergy.org.za/uploads/resource_217.pdf) [Accessed 22 April 2013].
- DIAS, T. 2013. *Personal Communication*. National Accounts Manager, MAN Truck and Bus, South Africa.
- ESKOM DISTRIBUTION. 2010. *Energy Losses Management Programme*. Johannesburg: Eskom Holdings Limited.
- ESKOM HOLDINGS LIMITED. 2011. *The Eskom Factor Report*. Johannesburg: Eskom Holdings Limited.
- EEO – ETHEKWINI ENERGY OFFICE. 2011. *Summary Document: eThekwini Greenhouse Gas Emissions Inventory 2011*. Durban: eThekwini Municipality.
- EM – ETHEKWINI MUNICIPALITY. 2014a. *Integrated Development Plan: Annual Report 2014/2015*. Durban: eThekwini Municipality.
- EM – ETHEKWINI MUNICIPALITY. 2014b. *Spatial Development Framework (SDF) Report 2014/15 Review*. [Online]. Available: [http://www.durban.gov.za/Resource\\_Centre/reports/Framework\\_Planning/Documents/SDF\\_Full\\_Report\\_2014\\_2015\\_May\\_2014.pdf](http://www.durban.gov.za/Resource_Centre/reports/Framework_Planning/Documents/SDF_Full_Report_2014_2015_May_2014.pdf) [Accessed 22 October 2014].
- EM – ETHEKWINI MUNICIPALITY. 2015a. *GO!Durban moves ahead in 2015* [Online]. Available: <http://www.godurban.co.za/category/media/> [Accessed 11 April 2015].
- EM – ETHEKWINI MUNICIPALITY. 2015b. *Implementation: Phase One* [Online]. Available: <http://www.godurban.co.za/implementation/phase-one/> [Accessed 22 October 2014].
- ETA – ETHEKWINI TRANSPORT AUTHORITY. 2005. *Public Transport Plan*. Durban: eThekwini Transport Authority.
- ETA – ETHEKWINI TRANSPORT AUTHORITY. 2012a. *ETA Annual Report 2012*. Durban: eThekwini Transport Authority.
-

- 
- ETA – ETHEKWINI TRANSPORT AUTHORITY. 2012b. INRO Emme 2 Transport Modelling Outputs.
- EAMA – EUROPEAN AUTOMOBILE MANUFACTURERS' ASSOCIATION. 2014. *Differences between diesel and petrol* [Online]. Available: <http://www.acea.be/news/article/differences-between-diesel-and-petrol> [Accessed 2 November 2014].
- EC – EUROPEAN COMMISSION. 2015a. *Reducing CO<sub>2</sub> emissions from passenger cars* [Online]. Available: [http://ec.europa.eu/clima/policies/transport/vehicles/cars/index\\_en.htm](http://ec.europa.eu/clima/policies/transport/vehicles/cars/index_en.htm) [Accessed 2 February 2015]
- EC – EUROPEAN COMMISSION. 2015b. *Reducing CO<sub>2</sub> emissions from Heavy-Duty Vehicles* [Online]. Available: [http://ec.europa.eu/clima/policies/transport/vehicles/heavy/index\\_en.htm](http://ec.europa.eu/clima/policies/transport/vehicles/heavy/index_en.htm): [Accessed 2 February 2015]
- GIBELA PRODUCT ENGINEERING. 2014. *Summary of the PRASA X'Trapolis Mega energy consumption*, Internal Report, Gibela Rail Transport Consortium.
- GOBA CONSULTING, MOTTMACDONALD & LMA. 2012a. Integrated Rapid Public Transport Network Preliminary Design Report. vol, 4.
- GOBA CONSULTING, MOTTMACDONALD & LMA. 2012b. IRPTN Operational Plan – Passenger Demand Analysis. vol, 2.
- GOODMAN, J., LAUBE, M. & SCHWENK, J. 2005. Curitiba's Bus System is Model for Rapid Transit. *Race, Poverty and the Environment* Winter 2005/2006, pp. 75-77.
- GRAY, G. & HOEL, L. 1992. *Public Transportation Second Edition*, New Jersey, Prentice Hall, Inc.
- GRÜTTER, J. 2011. *VCS Project Document BRT Rea Vaya Phase 1A and 1B, South Africa, Version 1.2*. Reinach: Grütter Consulting.
- HITGE, G. & VAN DIJK, E.N.R. 2012. Incremental Approach to Public Transport System Improvements. *Proceedings of the 31st Southern African Transport Conference*, 9-12 July 2012. Pretoria, South Africa, pp. 592-603.
-

- 
- INRO. 2013. INRO Emme Products. *INRO Software* [Online]. Available: <http://www.inrosoftware.com/assets/PDFs/emmebrochure.pdf> [Accessed 24 March 2014].
- IPCC – INTERGOVERNMENTAL PANEL ON CLIMATE CHANGE. 1996. Revised 1996 IPCC Guidelines for National Greenhouse Gas Inventories: Reference Manual. *Greenhouse Gas Inventory Reporting Instructions*.
- IPCC – INTERGOVERNMENTAL PANEL ON CLIMATE CHANGE. 2007. Climate Change 2007 Contribution of Working Group I to the Fourth Assessment Report of the IPCC *In: SOLOMON, S., QIN, D., MANNING, M., CHEN, Z., MARQUIS, M., AVERYT, K., M, T. & MILLER, H. (eds.) Climate Change 2007: The Physical Science Basis*. Cambridge: Cambridge University Press.
- JACKSON, A. 2003. *Public Transport in Durban - A brief history* [Online]. Available: <http://www.fad.co.za/Resources/transport/transport.htm> [Accessed 12 May 2013].
- KRUGER, E. 2012. *Current and Future Trends of the South African Car Parc*, National Association of Automobile Manufacturers of South Africa (NAAMSA). [Online]. Available: [http://www.energy.gov.za/files/IEP/presentations/CurrentFutureTrends\\_SA\\_CarParc\\_30MArch2012.pdf](http://www.energy.gov.za/files/IEP/presentations/CurrentFutureTrends_SA_CarParc_30MArch2012.pdf) [Accessed 12 March 2013]
- LE TREUT, H., SOMERVILLE, R., CUBASCH, U., DING, Y., MAURITZEN, C., MOKSSIT, A., PETERSON, T. & PRATHER, M. 2007. *Climate Change 2007: The Physical Science Basis. Contribution of Working Group I to the Fourth Assessment Report: Historical Overview of Climate Change Science*. Cambridge: Cambridge University Press.
- LEVINSON, S., ZIMMERMAN, S., CLINGER, J. & RUTHERFORD, C. 2002. Bus Rapid Transit: An Overview. *Journal of Public Transportation*, vol. 5, no. 2, pp. 1-29.
- LINDQVIST, K. 2012. *Emission standards for light and heavy road vehicles*, Fact sheet 25. Available: <http://www.airclim.org/sites/default/files/documents/Factsheet-emission-standards.pdf> [Accessed 22 January 2015].
- LITMAN, T. 2014. Public Transit. *Victoria Transport Policy Institute* [Online]. Available: <http://www.vtppi.org/railcrit.pdf> [Accessed 29 May 2014].
-



- 
- LIU, X., HILDEBRANDT, D. & GLASSER, D. 2012. Environmental impacts of electric vehicles in South Africa. *South African Journal of Science*, vol. 108, pp. 1-6.
- LGH – LOCAL GOVERNMENT HANDBOOK. 2012. *KwaZulu-Natal* [Online]. Available: <http://www.localgovernment.co.za/provinces/view/4/kwazulu-natal> [Accessed 2 October 2014].
- LUTHULI, T. 2013. *Personal Communication*. Infrastructure Engineering Services Manager, Passenger Rail Agency of South Africa.
- MECA – MANUFACTURERS OF EMISSION CONTROLS ASSOCIATION. 2010. Evaporative Emission Control Technologies for Gasoline Powered Vehicles. *Manufacturers of Emission Controls Association* [Online]. Available: [http://www.meca.org/galleries/files/MECA\\_Evap\\_White\\_Paper\\_Final.pdf](http://www.meca.org/galleries/files/MECA_Evap_White_Paper_Final.pdf) [Accessed 25 May 2014].
- MASIKANE, Z. & MKHIZE, N. 2012. *Bus commuters to benefit from new fleet* [Online]. Available: <http://showme.co.za/durban/news/bus-commuters-to-benefit-from-new-fleet/> [Accessed 2 October 2013].
- MATTHEWS, H., HENDRICKSON, C. & WEBER, C. 2008. The importance of carbon footprint estimation boundaries. *Environmental Science and Technology*, vol. 42, pp. 5839-5842.
- MBONAMBI, G. 2012. *Huge transport shake-up for Durban* [Online]. The Mercury Available: [http://www.iolproperty.co.za/roller/news/entry/huge\\_transport\\_shake\\_up\\_for](http://www.iolproperty.co.za/roller/news/entry/huge_transport_shake_up_for).
- MBONAMBI, G. 2013. *Personal Communication*. Senior Engineering Technician, Passenger Rail Agency of South Africa.
- MCCARTHY TOYOTA. 2013. Toyota Toolbox - New Cars. *Toyota Zone*. McCarthy Toyota.
- MCDONNELL, S., FERREIRAM, S. & CONVERY, F. 2008. Using Bus Rapid Transit to Mitigate Emissions of CO<sub>2</sub> from Transport. *Transport Reviews*, vol 28, no. 6, pp. 735-756.

- 
- MCMICHAEL, A., CAMPBELL-LENDRUM, D., CORVALÁN, C., EBI, K., GITHEKO, A., SCHERAGA, J. & WOODWARD, A. 2003. *Climate change and human health - risks and responses*, Geneva, World Health Organisation.
- MEJIA-DUGAND, S., HJELM, O., BAAS, L. & RIOS, R. 2012. Lessons from the spread of Bus Rapid Transit in Latin America. *Journal of Cleaner Production*, vol. 50, pp. 82-90.
- MERCEDES BENZ. 2014. *Sprinter Fuel Consumption* [Online]. Available: [http://www2.mercedes-benz.co.uk/content/media\\_library/unitedkingdom/mpc\\_unitedkingdom/ng\\_vans/new\\_vans/downloads/sprinter\\_fuel\\_consumption.object-Single-MEDIA.download.tmp/Sprinter%20Euro%205%2028%2005%2009%20-%20VCA%20Fuel%20Database.pdf](http://www2.mercedes-benz.co.uk/content/media_library/unitedkingdom/mpc_unitedkingdom/ng_vans/new_vans/downloads/sprinter_fuel_consumption.object-Single-MEDIA.download.tmp/Sprinter%20Euro%205%2028%2005%2009%20-%20VCA%20Fuel%20Database.pdf) [Accessed 10 January 2015].
- MOODLEY, G.Y., CHETTY, R., REDDY, J. & SIMMER, C. 2011. Developing the Integrated Rapid Public Transport Network (IRPTN) for the eThekweni Municipal Area. *Proceedings of the 30th Southern African Transport Conference*, 11-14 July 2011, Pretoria, South Africa, pp. 499-514.
- MOODLEY, G., MEINTSMA, J., VAN TONDER, M., KUPPAN, S. & BAKER, S. 2009. eThekweni Municipal Wide Household Travel Interview Survey: Travel Behaviour Findings. *Proceedings of the 28th Southern African Transport Conference*, 6-9 July 2009, Pretoria, South Africa, pp. 135-143.
- MOODLEY, L. 2013. *Personal Communication*. Civil Engineer, eThekweni Transport Authority, South Africa.
- MOSTERT, J. 2013. *Personal Communication*. Communications Officer, Transport Information Centre, Transport for Cape Town, South Africa
- NAIDOO, M. 2014. *Personal Communication*. Co-acting Senior Manager, eThekweni Energy Office, South Africa.
- NAIR, P. & KUMAR, D. 2005. Transformation in road transport system in Bogota: an overview. *ICFAI Journal of Infrastructure*, September, pp. 20-28.

- 
- NRCS – NATIONAL REGULATOR FOR COMPULSORY SPECIFICATIONS. 2014. *Taxi Recapitalisation* [Online]. National Department of Transport Available: <http://www.transport.gov.za/PublicTransport/Taxis/TaxiRecaptilization.aspx> [Accessed 20 May 2014].
- NDEBELE, S. 2011. *Minister of Transport Mr Sibusiso Ndebele addresses launch of Non-Motorised Transport legacy project* [Online]. Department of Environmental Affairs. [Accessed 11 February 2013].
- NMBMM – NELSON MANDELA BAY METROPOLITAN MUNICIPALITY. 2015. *Draft 2015 Metropolitan Spatial Development Framework (Review)*. Nelson Mandela Bay: Nelson Mandela Bay Metropolitan Municipality.
- NMBT – NELSON MANDELA BAY TOURISM. 2012. *Nelson Mandela Bay Municipality brings you Libhongolethu!* [Online]. Available: [http://www.nmbt.co.za/news/nelson\\_mandela\\_bay\\_municipality\\_brings\\_you\\_libhongolethu.html#sthash.mTRVijQf.dpuf](http://www.nmbt.co.za/news/nelson_mandela_bay_municipality_brings_you_libhongolethu.html#sthash.mTRVijQf.dpuf) [Accessed 22 November 2014].
- NMMM – NELSON MANDELA METROPOLITAN MUNICIPALITY. 2007. *Implementation of the PTP: implications of implementing a full BRT system, Draft 3*. Nelson Mandela Bay: Nelson Mandela Metropolitan Municipality.
- NH DoT – NEW HAMPSHIRE DEPARTMENT OF TRANSPORT. 2012. *Remaining Useful Life of Transit Buses* [Online]. New Hampshire Government. Available: [www.nh.gov/dot/org/commisioner/balanced-scorecard/department/documents/2012\\_bs\\_performance\\_transit\\_buseage.pdf](http://www.nh.gov/dot/org/commisioner/balanced-scorecard/department/documents/2012_bs_performance_transit_buseage.pdf) [Accessed 29 November 2014].
- NGWENYA, B. 2013. *Personal Communication*. General Manager, City Fleet, eThekweni Municipality, South Africa.
- ONATU, G. 2011. A new approach to sustainable transport systems: A critical appraisal of the Rapid Bus Transit System in South Africa. *Journal of Sustainable Development and Environmental Protection*, vol. 1, no. 2, pp. 89-97.
- OECD and IEA – ORGANISATION FOR ECONOMIC CO-OPERATION AND DEVELOPMENT & INTERNATIONAL ENERGY AGENCY. 2009. *Transport, Energy and CO<sub>2</sub>: Moving towards sustainability*. Paris: International Energy Agency.
-

- 
- PANDEY, D., AGRAWAL, M. & SHANKER PANDEY, J. 2011. Carbon Footprint: current methods of estimation. *Environmental Monitoring and Assessment*, vol. 178, no. 1-4, pp. 135-160.
- PRASA – PASSENGER RAIL AGENCY OF SOUTH AFRICA. 2007. *Metrorail - Rolling Stock* [Online]. Available: <http://www.metrorail.co.za/RollingStock.html> [Accessed 20 September 2013].
- PRASA – PASSENGER RAIL AGENCY OF SOUTH AFRICA. 2010. *PRASA Annual Report 2009/10*. Johannesburg: Passenger Rail Agency of South Africa
- PBL NEAA – PBL NETHERLANDS ENVIRONMENTAL ASSESSMENT AGENCY. 2014. *Trends in global CO<sub>2</sub> emissions: 2014 Report*. Hague: PBL Publishers.
- PIOTRANS. 2011. *Stakeholders* [Online]. Available: <http://www.reavaya.org.za/component/content/article/156-february-2011/645-new-bus-operating-company-launched> [Accessed 22 August 2013].
- PRETORIUS, T. & VANDERSCHUREN, M. 2012. Voluntary Transport Demand Management: Route Choice Study in Port Elizabeth. *Proceedings of the 31st Southern African Transport Conference*. 9-12 July 2012, Pretoria, South Africa, pp. 70-80.
- PROZZI, J., NAUDE, C., SPERLING, D. & DELUCCHI, M. 2002. *Transportation in Developing Countries: Greenhouse gas scenarios for South Africa*. Arlington: Pew Center on Global Climate Change.
- RSA – REPUBLIC OF SOUTH AFRICA. 2009. National Land Transport Act, Act 5 of 2009. Cape Town: The Presidency, Republic of South Africa.
- ROBERTS, D. 2008. Thinking globally, acting locally- institutionalising climate change at the local government level in Durban, South Africa. *International Institute for Environment and Development (IIED)*, vol. 20, pp. 521-537.
- RLM – RUSTENBURG LOCAL MUNICIPALITY. 2015. *Rustenburg Rapid Transport* [Online]. Available: <http://www.rustenburg.gov.za/?q=node/87> [Accessed 30 January 2015].
-

- 
- SCENARIO BUILDING TEAM. 2007. *Long Term Mitigation Scenarios: Strategic Options for South Africa*. Pretoria: Department of Environment Affairs and Tourism.
- SCHALEKAMP, H. & BEHRENS, R. 2010. Engaging paratransit on PT reform initiatives in SA: A critique of policy and an investigation of appropriate engagement approaches. *Research in Transportation Economics*, vol. 29, pp. 371-378.
- SCHILZ, E. 2013. *The People Mover* [Online]. Available: <http://durbangoldenmile.blogspot.com/2013/06/the-people-mover.html> [Accessed 2 March 2014].
- SIYONGWANA, P. & BINZA, M. 2012. Challenges facing the transformation of the public transport system in Nelson Mandela Bay, South Africa : history in the making. *Journal for Contemporary History*, vol. 37, pp. 191-202.
- SABC – SOUTH AFRICAN BROADCASTING CORPORATION. 2012. *Calls made for inquiry into PE's BRT system* [Online]. Available: <http://www.sabc.co.za/news/a/0006c3004cb4b13ca6a1e6b060346904/Calls-made-for-inquiry-into-PE%E2%80%99s-BRT-system-20121309> [Accessed 22 November 2014].
- STATISTICS SOUTH AFRICA. 2014. *P0302 - Mid-year population estimates* [Online]. Available: <http://beta2.statssa.gov.za/publications/P0302/P03022014.pdf> [Accessed 25 October 2014].
- STEENBRINK, P. 1974. *Optimization of Transport Networks*, London, John Wiley and Sons.
- TSA – TAXI SCRAPPING ADMINISTRATOR. 2009. *Progress Statistics* [Online]. Available: [www.scraptaxi.org/ScrappingStats.aspx](http://www.scraptaxi.org/ScrappingStats.aspx) [Accessed 30 October 2013].
- THAMBIRAN, T. & DIAB, R. 2011. Air pollution and climate change co-benefit opportunities in the road transport sector in Durban, South Africa. *Atmospheric Environment*, vol. 45, pp. 2683-2689.
- TRANSPORT FOR CAPE TOWN. 2013. *About MyCiTi* [Online]. Available: <http://myciti.org.za/en/about/about-us/about-myciti/> [Accessed 3 August 2014].
- TUFTS UNIVERSITY. 2015. *Curitiba - How Did it Happen?* [Online]. Available: <https://sites.tufts.edu/sustainablebrt/files/2015/04/Slide1.png> [Accessed 2 April 2015].
-

- 
- US EPA – UNITED STATES ENVIRONMENTAL PROTECTION AGENCY. 2004. MOBILE6.2 Model Run assumed IDLE Test, National Low Emission Vehicle Standards, summer temperature 64-92 degrees, and United States average vehicle operations.
- US EPA – UNITED STATES ENVIRONMENTAL PROTECTION AGENCY: OFFICE OF MOBILE SOURCES. 2005. *Automobile Emissions: An Overview*. Available: <http://www.epa.gov/otaq/consumer/05-autos.pdf> [Accessed 15 October 2014].
- URS NZL – URS NEW ZEALAND LIMITED. 2008. *Petrol and Diesel in South Africa and the impact on air quality* [Online]. Available: [www.sapia.co.za](http://www.sapia.co.za) [Accessed 25 May 2014].
- VENTER, C. 2013. The lurch towards formalisation: Lessons from implementation of BRT in Johannesburg, South Africa. *Research in Transport Economics* 39, 114-120.
- VUCHIC, V. 1981. *Urban Public Transport: Systems and Technology*, New Jersey, Prentice-Hall Inc.
- WALTERS, J. 2013. Overview of public transport policy developments in South Africa. *Research in Transportation Economics*, vol. 39, pp. 34-45.
- WIEDMANN, T. & MINX, J. 2008. A Definition of 'Carbon Footprint'. In: PERTSOVA, C. (ed.) *Ecological Economics Research Trends*. New York: Nova Science Publishers.
- WILKINSON, J. 2013. *Personal Communication*. General Manager, Tansnat Durban, South Africa.
- WÖHRNSCHIMMEL, H., ZUK, M., MARTINEZ-VILLA, G., CERON, J., CARDENAS, B., ROJAS-BRACHO, L. & FERNANDEZ-BREMAUNTZ, A. 2008. The impact of a Bus Rapid Transit system on commuters exposure to benzene, CO, PM2.5 and PM10 in Mexico City. *Atmospheric Environment*, vol. 42, pp. 8194-8203.
- WRIGHT, L. & HOOK, W. 2007. *Bus Rapid Transit: Planning Guide 2007*. New York: Institute for Transportation and Development Policy.
- ZAHABI, S., MIRANDA-MORENA, L., PATTERSON, Z., BARLA, P. & HARDING, C. 2012. Transportation Greenhouse Gas Emissions and its Relationship with Urban Form,

Transit Accessibility and Emerging Green Technologies: A Montreal case study.  
*Procedia - Social and Behavioural Sciences*, vol. 54, pp. 996-978.

**APPENDIX A**  
**NRCS TAXI RECAPITALISATION PROGRAMME LIST**



TRP List for vehicles complying to September 2007 & SANS 20107 Clause 7.6

TRP 2009

NO	COMPANY	CATEGORY	NAME	MODEL NAME	SEATING CAPACITY	CERTIFICATE NUMBER	DATE OF ISSUE	EXPIRY DATE	COMMENTS
1	Bustruck Marketing	Midi Bus	Mercedes Benz	Sprinter 518	22	556739-TRP07-0311	13/06/2011	31/12/2014	
2	Amalgamated Automobile Distributors	Minibus	Foton	2.2 Petrol 13 Seater	14	550713-TRP07-0309	17/06/2011	31/12/2014	
3	Whallinger	Minibus	CAM	Inyathi XGD 2.2i	14	541394-TRP07-0609	17/06/2011	31/12/2014	
4	Toyota SA	Minibus	Toyota	Quantum 2.7P 15S TAXI	15	555664-TRP07-1110	17/06/2011	31/12/2014	
5	CCE Motor Holdings	Minibus	CMC	Amandla	14	550826-TRP07-0609	20/06/2011	31/12/2014	
6	Nanfeng Automobile	Minibus	Ekhaya	Ekhaya 2.2i Hatch	14	551700-TRP07-0709	17/06/2011	31/12/2014	
7	Great Wall motors	Minibus	GWM	Proteus Mpi	14	551517-TRP07-0709	17/06/2011	31/12/2014	
8	Mr Coach	Midi Bus	Mercedes Benz	Sprinter 518	22	551798-TRP07-0809	17/06/2011	31/12/2014	
9	Mr Coach	Midi Bus	VW Crafter	VW Crafter 50	22	551799-TRP07-0809	17/06/2011	31/12/2014	
10	Bustruck Marketing	Minibus	Fiat	Ducato 250	16	551958-TRP07-0809	13/06/2011	31/12/2014	
11	Bustruck Marketing	Midi Bus	Fiat	Ducato 250	19	552898-TRP07-1209	13/06/2011	31/12/2014	
12	Bustruck Marketing	Midi Bus	Peugeot	Boxer	19	557082-TRP07-0411	13/06/2011	31/12/2014	
13	Bustruck Marketing	Midi Bus	Peugeot	Boxer	16	551959-TRP07-0809	13/06/2011	31/12/2014	
14	Bustruck Marketing	Midi Bus	Mercedes Benz	Sprinter 416	22	556740-TRP07-0311	13/06/2011	31/12/2014	
15	Bustruck Marketing	Midi Bus	VW Crafter	VW Crafter 50	22	554295-TRP07-0510	13/06/2011	31/12/2014	

TRP List for vehicles complying to September 2007 & SANS 20107 Clause 7.6

TRP 2009

NO	COMPANY	CATEGORY	NAME	MODEL NAME	SEATING CAPACITY	CERTIFICATE NUMBER	DATE OF ISSUE	EXPIRY DATE	COMMENTS
16	Centurion Bus Manufacturers	Midi Bus	Iveco	Daily 3.0 HPI	22	552023-TRP07-0909	17/06/2011	31/12/2014	
17	Cash Asset t/a PA Shop	Minibus	Zejiang Gonow	Gonow GA 6530	14	555076-TRP07-0910	17/06/2011	31/12/2014	
18	Readyform	Midi Bus	VW Crafter	VW Crafter 50	22	551883-TRP07-0709	17/06/2011	31/12/2014	
19	Star Force Motors	Midi Bus	Force	Traveller TR11	18	551986-TRP07-0809	17/06/2011	31/12/2014	
20	Bustruck Marketing	Midi Bus	Iveco	Daily 3.0 HPI	22	552897-TRP07-0909	13/06/2011	31/12/2014	
21	Mr Coach	Midi Bus	Mercedes Benz	Sprinter 416	22	556253-TRP07-1210	17/06/2011	31/12/2014	
22	Readyform	Midi Bus	Mercedes Benz	Sprinter 518	22	551884-TRP07-0909	17/06/2011	31/12/2014	
23	Climatic Technology	Midi Bus	Mercedes Benz	Sprinter 416	22	552145-TRP07-0909	17/06/2011	31/12/2014	
24	Danzig Trading 55	Minibus	Jinbei	Siyavaya Haise	14	552206-TRP07-0909	17/06/2011	31/12/2014	
25	Angelo Kater	Midi Bus	Mercedes Benz	Sprinter 416	22	552286-TRP07-1009	17/06/2011	31/12/2014	
26	Angelo Kater	Midi Bus	Mercedes Benz	Sprinter 518	22	552287-TRP07-1009	17/06/2011	31/12/2014	
27	Mr Coach	Midi Bus	Iveco	Daily 3.0 HPI	22	552208-TRP07-1009	17/06/2011	31/12/2014	
28	TFM Industries	Midi Bus	Mercedes Benz	Sprinter 416	22	552093-TRP07-1009	20/06/2011	31/12/2014	
29	Angelo Kater	Midi Bus	VW Crafter	VW Crafter 50	22	562781-TRP07-1113	15/03/2013	31/12/2014	Amended



national regulator for  
compulsory specifications

NO	COMPANY	CATEGORY	NAME	MODEL NAME	SEATING CAPACITY	CERTIFICATE NUMBER	DATE OF ISSUE	EXPIRY DATE	COMMENTS
30	Readyform 1087 cc	Mini Bus	Volkswagen	Crafter 35	16	553165-TRP07-0110	20/06/2011	31/12/2014	
31	Angelo Kater	Midi Bus	Iveco	50C15V15	22	552402-TRP07-1009	17/06/2011	31/12/2014	
32	Mr Coach	Mini Bus	Mercedes Benz	Sprinter 309	16	552884-TRP07-1209	17/06/2011	31/12/2014	
33	CCE Motor Holdings	Mini Bus	CMC	Sesbuyile	16	552877-TRP07-1209	20/06/2011	31/12/2014	
34	Bustruck	Midi Bus	Fiat	Ducato 250	19	552898-TRP07-1209	13/06/2011	31/12/2014	
35	Mr Coach	Mini Bus	Volkswagen	Crafter 35	16	555754-TRP07-1110	20/06/2011	31/12/2014	
36	Bustruck	Mini Bus	Volkswagen	Crafter 35	16	552930-TRP07-1209	20/06/2011	31/12/2014	
37	Whallinger	Mini Bus	Jiangsu Joylong	CAM Indlovu	15	553152-TRP-1210	13/06/2011	31/12/2014	
38	Bus Africa Importation	Midi Bus	Zhengzhou Yutong	ZK 6608 DM	23	553061_TRP07-0110	20/06/2011	31/12/2014	
39	Angelo Kater	Mini Bus	Mercedes Benz	Sprinter 309	16	553142-TRP07-0110	20/06/2011	31/12/2014	
40	Bustruck Marketing	Mini Bus	Mercedes Benz	Sprinter 309	16	552934-TRP07-1110	20/06/2011	31/12/2014	
41	Angelo Kater Motor	Mini Bus	Volkswagen	Crafter 35	16	553372-TRP07-0210	20/06/2011	31/12/2014	
42	Amalgamated Automobile Distributors	Mini Bus	Foton	Inkunzi	14	552739-TRP07-1210	20/06/2011	31/12/2014	
43	Mr Coach cc	Mini Bus	Mercedes Benz	Sprinter 315	16	555764-TRP07-1110	20/06/2011	31/12/2014	
44	F&R Phakisa	Mini Bus	Toyota	Dyna	14	552743-TRP07-0310	20/06/2011	31/12/2014	
45	Star Force	Mini Bus	Force	Traveller	15	553743- TRP07-0310	20/06/2011	31/12/2014	
46	Jinbei SA (Pty) Ltd	Mini Bus	Auto Brilliance	Brilliance	14	553891-TRP07-1210	20/06/2011	31/12/2014	
47	Whallinger SA (Pty) Ltd	Mini Bus	Jiangsu Joylong	JoyLong Indlovu	16	554122-TRP07-1210	13/06/2011	31/12/2014	



national regulator for  
compulsory specifications

NO	COMPANY	CATEGORY	NAME	MODEL NAME	SEATING CAPACITY	CERTIFICATE NUMBER	DATE OF ISSUE	EXPIRY DATE	COMMENTS
48	Mr Coach cc	Midi Bus	Volkswagen	Crafter RoofHatch	22	553937-TRP07-0410	20/06/2011	31/12/2014	
49	Mr Coach cc	Midi Bus	Volkswagen	Crafter 50 RoofHatch	22	553938-TRP07-0410	20/06/2011	31/12/2014	
50	Mr Coach cc	Midi Bus	Volkswagen	Crafter RoofHatch	22	553939-TRP07-0410	20/06/2011	31/12/2014	
51	Whallinger	Mini Bus	CAM	Inyathi XGD 2.2i	14	541394-TRP07-0510	17/06/2011	31/12/2014	High Roof
52	Whallinger	Mini Bus	CAM	Inyathi BAW 2.2i	14	554176-TRP07-0510	20/06/2011	31/12/2014	High Roof
53	Iveco South Africa	Midi Bus	Iveco	Power Daily A4213	17	554237-TRP07-0510	20/06/2011	31/12/2014	
54	Angelo Kater Motor	Midi Bus	Fiat	Ducato 250	19	554161-TRP07-0510	20/06/2011	31/12/2014	
55	Angelo Kater Motor	Midi Bus	Mercedes Benz	Sprinter 515	22	554145 -TRP07-0510	28/06/2011	31/12/2014	
56	Mr Coach	Midi Bus	Mercedes Benz	Sprinter 515	22	554301-TRP07-0510	20/06/2011	31/12/2014	
57	Readyform 1087 cc	Midi Bus	Mercedes Benz	Sprinter 416	22	552757-TRP07-0110	20/06/2011	31/12/2014	
58	Iveco South Africa	Midi Bus	Iveco	Power Daily A5013	20	554739-TRP07-0710	20/06/2011	31/12/2014	
59	Midissia Trading 100	Mini Bus	Meiya	2.2L RoofHatch	14	554240-TRP07-0610	09/06/2011	31/12/2014	
60	Star Force Motors	Mini Bus	Golden Journey	Ibhubezi 2.2i	14	554932-TRP07-0810	20/06/2011	31/12/2014	
61	Angelo Kater Motor	Minibus	Mercedes Benz	Sprinter 315 SWB Roof Hatch	16	553849-TRP07-0310	20/06/2011	31/12/2014	
62	Bustruck Marketing	Minibus	Mercedes Benz	Sprinter 315 Escape Hatch	16	554991-TRP07-1110	20/06/2011	31/12/2014	



Cash Asset T/A PA Shop

national regulator for compulsory specifications

63	Cash Asset T/A PA Shop	Mibus	Zhejiang Gonow	Gonow Minibus GA6530	14	555076-TRP07-0910	17/06/2011	31/12/2014
64	Bustruck Marketing	Minibus	Mercedes Benz	Sprinter 515	22	554611-TRP07-1210	13/06/2011	31/12/2014
65	Sportsvans	Midibus	Mercedes Benz	Sprinter 416 CDI	22	555276-TRP07-0910	20/06/2011	31/12/2014
66	CCE Motor Holdings	Midibus	CMC	Ziyabuya ZK 6608DM	22	556121-TRP07-1210	20/06/2011	31/12/2014
67	CCE Motor Holdings	Midibus	Yutong	Ziyabuya ZK 6608DM	22	556122-TRP07-1210	20/06/2011	31/12/2014
68	Climatic Technology	Minibus	Mercedes Benz	Sprinter 315 Roof Hatch	16	553583-TRP07-1210	20/06/2011	31/12/2014
69	Ashok Leyland	Midibus	Eshok Leyland	Eland Bus	23	556293-TRP07-1101	20/06/2011	31/12/2014
70	Springfield Auto Trimmers	Midibus	Mercedes Benz	Sprinter 413	22	556326-TRP07-0111	20/06/2011	31/12/2014
71	Mr Coach cc	Midibus	Iveco	Daily 35512V8	22	556573-TRP07-0311	20/06/2011	31/12/2014

Taxi Recapitalization Programme list
TRP List for vehicles complying to September 2007 & SANS 20107 Clause 7.6
TRP 2009

NO	COMPANY	CATEGORY	NAME	MODEL NAME	SEATING CAPACITY	CERTIFICATE NUMBER	DATE OF ISSUE	EXPIRY DATE	COMMENTS
72	TFM Manufacturing	Midibus	Mercedes Benz	Sprinter 416 Escape Hatch	22	556642-TRP07-0211	20/06/2011	31/12/2014	
73	Climatic Technology	Midibus	Mercedes Benz	Sprinter 518 Escape Hatch	22	557184-TRP07-0411	26/04/2011	31/12/2014	
74	Climatic Technology	Midibus	Mercedes Benz	Sprinter 518 Escape Hatch	20	557185-TRP07-0411	26/04/2011	31/12/2014	
75	Climatic Technology	Minibus	Mercedes Benz	Sprinter 309 Escape Hatch	16	557152-TRP07-0411	29/04/2011	31/12/2014	
76	Springfeild Auto Trimmers	Midi Bus	Mercedes Benz	Sprinter 412 Escape Hatch	22	557495-TRP07-2411	13/06/2011	31/12/2014	
77	Toyota SA	Mini Bus	Toyota	Quantum 2.5D 15s Taxi	15	555663-TRP07-1110	17/06/2011	31/12/2014	
78	Amalgamated Automobile Distributors	Minibus	Chery	Ro Swika P-10	15	557713-TRP07-2811	12/07/2011	31/12/2014	
79	CCE Motor Holdings	Mini Bus	CMC	Sesbuyile 2.7 Petrol Roof hatch	16	558003-TRP07-3011	28/07/2011	31/12/2014	
80	CCE Motor Holdings	Mini Bus	CMC	Sesbuyile 2.5 Diesel Roof hatch	16	558006-TRP07-3011	28/07/2011	31/12/2014	
81	Star Force Motor	Minibus	Golden Journey	Makoya 16S 2.4i	16	558267-TRP07-3611	08/09/2011	31/12/2014	



national regulator for  
 compliance specifications  
**Taxi Recapitalization Programme list**

**TRP List for vehicles complying to September 2007 & SANS 20107 Clause 7.6**

**TRP 2009**

NO	COMPANY	CATEGORY	NAME	MODEL NAME	SEATING CAPACITY	CERTIFICATE NUMBER	DATE OF ISSUE	EXPIRY DATE	COMMENTS
82	Mr Coach	Mini Bus	Volkswagen	Crafter 35 Escape Hatch	16	553031-TRP07-1209	20/06/2011	31/12/2014	
83	CCE Motor Holdings	Mini Bus	CMC	Amandla Minibus Roof hatch	14	558907-TRP07-4511	10/11/2011	31/12/2014	
84	Sportsvans	Minibus	Volkswagen	Crafter 50 Escape Hatch	22	558674-TRP07-5311	26/10/2011	31/12/2014	
85	Mr Coach	Midibus	Mercedes Benz	Sprinter 416 Escape Hatch	22	559848-TRP07-0912	2012/02/03	31/12/2014	
87	Mr Coach	Mini Bus	Mercedes Benz	Sprinter 311 CDI Low Roof	16	560132-TRP07-1412	03/04/2012	31/12/2014	
88	Toyota SA (Pty) LTD	Mini Bus	Toyota Quantum	2.7P 16S TAXI 12	16	560278-TRP07-1212	04/04/2012	31/12/2014	
89	Toyota SA (Pty) LTD	Mini Bus	Toyota Quantum	2.7P 16S TAXI 12	16	560279-TRP07-1312	04/04/2012	31/12/2014	
90	Toyota SA (Pty) LTD	Mini Bus	Toyota Quantum	2.5 D-4D 16S Taxi 12	16	560280-TRP07-1412	04/04/2012	31/12/2014	
91	Tata Automobile Corp.	Midi Bus	Tata	Tata LP 713	27	560020-TRP07-1212	06-06-2012	31/12/2014	
92	Angelo Kater Motor	Midibus	Mercedes Benz	Sprinter 519 CDI Roof Hatch	22	564369-TRP07-1412	05-04-2012	31/12/2014	Amended
93	Mr Coach	Midibus	Mercedes Benz	Sprinter 413 CDI Escape Hatch (Used)	22	560484-TRP07-1812	08-05-2012	31/12/2014	
94	Bustruck Marketing	Minibus	Mercedes Benz	Sprinter 311 CDI	16	560018-TRP07-1712	26-04-2012	31/12/2014	
95	Bustruck Marketing	Minibus	FIAT	Ducato 120	16	560407-TRP07-1712	26-04-2012	31/12/2014	
96	Mr. Coach	Minibus	Mercedes Benz	Sprinter 519	22	560372-TRP07-1512	13-04-2012	31/12/2014	

TRP List for vehicles complying to September 2007 & SANS 20107 Clause 7.6

TRP 2009

NO	COMPANY	CATEGORY	NAME	MODEL NAME	SEATING CAPACITY	CERTIFICATE NUMBER	DATE OF ISSUE	EXPIRY DATE	COMMENTS
97	The Fitment Zone	Midibus	Mercedes Benz	Sprinter 519 CDI Roof Hatch	22	560583-TRP07-1912	08-05-2012	31/12/2014	
98	The Fitment Zone	Midibus	Volkswagen	VW Crafter 50 CDI Roof Hatch	22	560601-TRP07-1912	09-05-2012	31/12/2014	
99	The Fitment Zone	Midibus	Mercedes Benz	Sprinter 515 CDI Roof Hatch	22	560606-TRP-1912	10-05-2012	31/12/2014	
100	Bustruck Marketing	Midibus	Mercedes Benz	Sprinter 519 CDI Roof Hatch	22	560607-TRP-1912	10-05-2012	31/12/2014	
101	Mandarin Motors	Minibus	SAIC Motor Corporation	Maxus V80 2.5i	16	560742-TRP-2212	01-06-2012	31/12/2014	
102	Angelo Kater Motor	Minibus	Iveco	Daily 35S12V12	16	558524-TRP07-2412	15-06-2012	31/12/2014	
103	Angelo Kater Motor	Minibus	Mercedes Benz	Sprinter 311 CDI Roof Hatch	16	560860-TRP07-2512	20-06-2012	31/12/2014	
104	Climatic Technologies	Midibus	Mercedes Benz	Sprinter 519 CDI Roof Hatch	22	560419-TRP07-2612	28-06-2012	31/12/2014	
105	Bustruck Marketing	Mini bus	Citroen	Relay L2H1 100 HDI	15	561520-TRP01-3812	24-08-2012	31/12/2014	
106	F and R Catai Transport Solutions	Minibus	F and R Catai	Isuzu NLR 150- TRP Roofhatch	14	561639-TRP07-3612	04/09/2012	31/12/2014	
107	TFM Manufacturing	Midibus	Iveco	Daily 50C15	22	562082-TRP07-4312	25/10/2012	31/12/2014	
108	TFM Manufacturing	Midibus	Mercedes-Benz	Sprinter 515 CDI	22	561979-TRP07-4312	25/10/2012	31/12/2014	
109	TFM Manufacturing	Midibus	Volkswagen	Crafter 50	22	548487-TRP07-0913	25/02/2013	31/12/2014	



110	Angelo Kater Motor	Minibus	Citroen	Relay L3H2 HDI 180	22	563091-TRP07-1113	15/03/2013	31/12/2014
111	Bustruck Marketing cc	Minibus	Citroen	Relay L3H2 HDI 180	16	562919-TRP07-2213	30/05/2013	31/12/2014
112	Bustruck Marketing cc	Midibus	Citroen	Relay L4H2 HDI 180	19	562506-TRP07-2213	30/05/2013	31/12/2014
113	China Africa Motors (Pty) Ltd	Minibus	BAW	BAW 009	16	561861-TRP07-1513	10/04/2013	31/12/2014
114	Jinbei SA	Minibus	Jinbei	H2 16 2.4P TRP	16	564477-TRP07-4113	11/10/2013	31/12/2014
115	Jinbei SA	Minibus	Jinbei	H2 16 2.5 TD TRP	16	564478-TRP07-4113	11/10/2013	31/12/2014
116	Iveco South Africa	Minibus	Iveco	35S112V12	16	564527-TRP09-1342	15/10/2013	31/12/2014
117	Iveco South Africa	Minibus	Iveco	50C15V15	22	564530-TRP09-1342	15/10/2013	31/12/2014
118	Bustronix cc.	Midibus	Volkswagen	Crafter 50	22	565068-TRP11-4313	21/10/2013	31/12/2014

**APPENDIX B**  
**SAMPLE CO<sub>2</sub>e EMISSION CALCULATION**

---

**BAU Scenario Bus CO<sub>2</sub>e Emissions – Option 1**

Year	Fuel Consumption (L/km)	Emission Factor (gCO <sub>2</sub> e/L)	Emission Factor (gCO <sub>2</sub> e/km)	Annual bus-km	Emissions (tCO <sub>2</sub> e)
2008	0.550	2 684	1 476.20	100 000 000	147 620
2009	0.550		1 476.20	101 000 000	149 096
2010	0.550		1 476.20	102 000 000	150 572
2011	0.550		1 476.20	103 000 000	152 049
2012	0.550		1 476.20	104 000 000	153 525
2013	0.550		1 476.20	105 000 000	155 001
2014	0.548		1 471.19	106 000 000	155 946
2015	0.548		1 471.19	107 000 000	157 418
2016	0.548		1 471.19	108 000 000	158 889
2017	0.543		1 456.17	109 000 000	158 722
2018	0.543		1 456.17	110 000 000	160 178
2019	0.538		1 444.48	111 000 000	160 337
2020	0.531		1 424.45	112 000 000	159 538
2021	0.527		1 414.43	113 500 000	160 538
2022	0.527		1 414.43	115 000 000	162 659
2023	0.527		1 414.43	116 500 000	164 781
2024	0.519		1 392.73	118 000 000	164 342
2025	0.519		1 392.73	119 500 000	166 431
2026	0.519		1 392.73	121 000 000	168 520
2027	0.519		1 392.73	122 500 000	170 609
2028	0.519		1 392.73	124 000 000	172 698
2029	0.519		1 392.73	125 500 000	174 787
2030	0.519		1 392.73	127 000 000	176 876

---

---

**BAU Scenario Bus CO<sub>2</sub>e Emissions – Option 2**

Year	Fuel Consumption (L/km)	Emission Factor (gCO <sub>2</sub> e/L)	Emission Factor (gCO <sub>2</sub> e/km)	Annual bus-km	Emissions (tCO <sub>2</sub> e)
2008	0.55	2 684	1 476.20	100 000 000	147 620
2009			1 476.20	101 000 000	149 096
2010			1 476.20	102 000 000	150 572
2011			1 476.20	103 000 000	152 049
2012			1 476.20	104 000 000	153 525
2013			1 461.44	105 000 000	153 451
2014			1 446.82	106 000 000	153 363
2015			1 432.36	107 000 000	153 262
2016			1 418.03	108 000 000	153 147
2017			1 403.85	109 000 000	153 020
2018			1 389.81	110 000 000	152 879
2019			1 375.91	111 000 000	152 727
2020			1 362.16	112 000 000	152 561
2021			1 348.53	113 500 000	153 059
2022			1 335.05	115 000 000	153 531
2023			1 321.70	116 500 000	153 978
2024			1 308.48	118 000 000	154 401
2025			1 295.40	119 500 000	154 800
2026			1 282.44	121 000 000	155 176
2027			1 269.62	122 500 000	155 528
2028			1 256.92	124 000 000	155 858
2029			1 244.35	125 500 000	156 166
2030			1 231.91	127 000 000	156 452

---

---

**BAU Scenario Bus CO<sub>2</sub>e Emissions – Option 3**

Year	Fuel Consumption (L/km)	Emission Factor (gCO <sub>2</sub> e/L)	Emission Factor (gCO <sub>2</sub> e/km)	Annual bus-km	Emissions (tCO <sub>2</sub> e)
2008	0.550	2 684	1 476.20	100 000 000	147 620
2009	0.550		1 476.20	101 000 000	149 096
2010	0.550		1 476.20	102 000 000	150 572
2011	0.550		1 476.20	103 000 000	152 049
2012	0.550		1 476.20	104 000 000	153 525
2013	0.550		1 476.20	105 000 000	155 001
2014	0.541		1 453.33	106 000 000	154 053
2015	0.541		1 453.33	107 000 000	155 507
2016	0.541		1 453.33	108 000 000	156 960
2017	0.516		1 384.73	109 000 000	150 935
2018	0.516		1 384.73	110 000 000	152 320
2019	0.496		1 331.37	111 000 000	147 782
2020	0.462		1 239.90	112 000 000	138 869
2021	0.445		1 194.17	113 500 000	135 538
2022	0.445		1 194.17	115 000 000	137 329
2023	0.445		1 194.17	116 500 000	139 120
2024	0.408		1 095.07	118 000 000	129 218
2025	0.408		1 095.07	119 500 000	130 861
2026	0.408		1 095.07	121 000 000	132 504
2027	0.408		1 095.07	122 500 000	134 146
2028	0.408		1 095.07	124 000 000	135 789
2029	0.408		1 095.07	125 500 000	137 432
2030	0.408		1 095.07	127 000 000	139 074

---